

The role of abiotic processes in the formation and degradation of gaseous nitrogen compounds in the soil

Inaugural-Dissertation
zur
Erlangung des Grades

Doktor der Agrarwissenschaften
(Dr. agr.)

der
Landwirtschaftlichen Fakultät
der
Rheinischen Friedrich-Wilhelms-Universität Bonn

vorgelegt von

Jannis Heil

aus Essen

Bonn 2015

Referent: Prof. Dr. Nicolas Brüggemann

Korreferent: Prof. Dr. Wulf Amelung

Tag der mündlichen Prüfung: 10.08.2015

Contents

Acknowledgements	IV
Abstract	V
Zusammenfassung	VII
List of Figures	IX
List of Tables.....	XI
List of abbreviations.....	XII
1. Introduction	1
1.1. Rationale	2
1.2. Objectives and outline of the thesis	5
2. A review of chemical nitrogen trace gas formation reactions of nitrification intermediates in soils.....	9
2.1. The role of nitrification intermediates in abiotic nitrogen trace gas formation	10
2.2. Accumulation of NO_2^-	12
2.2.1 Role of soil properties.....	12
2.2.2 Agricultural practices.....	13
2.2.3 Drying/rewetting in seasonally dry ecosystems.....	14
2.3. Abiotic N trace gas production mechanisms.....	15
2.3.1 Self-decomposition of NO_2^-	15
2.3.2 Reactions of NO_2^- with metals.....	17
2.3.3. Reactions of NO_2^- with SOM	20
2.3.4. Reactions involving hydroxylamine	23
2.4. Implications of abiotic processes in terrestrial N trace gas emissions	27
2.5. Outlook.....	30
3. Site-specific ^{15}N isotopic signatures of abiotically produced N_2O	32
3.1. Introduction	33
3.2. Materials and Methods	34

3.2.1. Preliminary experiments	34
3.2.2. Laboratory setup for isotope-specific N ₂ O measurements.....	35
3.2.3. Instrumentation	38
3.3. Results	39
3.3.1. NO and N ₂ O production from nitrification intermediates NH ₂ OH and NO ₂ ⁻	39
3.3.2. Isotopic signatures of abiotically produced N ₂ O	41
3.4. Discussion	45
3.4.1. NO and N ₂ O production from nitrification intermediates NH ₂ OH and NO ₂ ⁻	45
3.4.2. Comparison of reaction mechanisms	46
3.4.3. Comparison with other studies.....	48
3.4.4. Mechanism leading to high positive SP	48
3.4.5. Source partitioning.....	49
3.5. Conclusions	50
4. Abiotic N₂O production from hydroxylamine in soils and their dependence on soil properties.....	52
4.1. Introduction	53
4.2. Material and methods	54
4.2.1. Sample collection.....	54
4.2.2. Soil chemical analyses	55
4.2.3. Incubation experiments	55
4.2.4. Reaction kinetics analyses	57
4.2.5. N ₂ O isotopic analyses	58
4.2.6. Calculations.....	59
4.3. Results	59
4.3.1. Soil incubation experiments.....	59
4.3.2. Kinetics of N ₂ O formation	62
4.3.3. Isotopic signature of produced N ₂ O.....	64
4.4. Discussion	65
4.4.1. Abiotic N ₂ O formation from different soils.....	65
4.4.2. Factors influencing abiotic N ₂ O formation	67
4.4.3. Isotopic signature of abiotically produced N ₂ O	70
4.5. Conclusions	70
5. N₂O decomposition over hot and dry surfaces.....	72
5.1. Introduction	73

5.2. Materials and Methods	74
5.3. Results	76
5.4. Discussion	79
5.5. Conclusions	81
6. Synopsis	82
6.1. Summary	83
6.2. Synthesis	86
6.3. Perspectives	89
6.3.1. Source partitioning using stable isotopes.....	89
6.3.2. Abiotic NH ₂ OH oxidation in soils	90
6.3.3. N ₂ O decomposition over hot and dry surfaces	91
References	92

Acknowledgments

First, I would like to acknowledge the contribution of my supervisor and first examiner of this thesis Nicolas Brüggemann for all the support during the past years, the excellent ideas, and constructive criticism. I am also thankful to Harry Vereecken, the director of the Agrosphere Institute at the Forschungszentrum Jülich, for the half-yearly discussions and for giving me the opportunity to do my research at the IBG-3. Further I would like to thank Wulf Amelung for accepting to be the second examiner of this thesis and the faculty of agriculture for funding part of my work.

For helping me in designing and constructing my experimental setups I am sincerely grateful to Holger Wissel and Franz Leistner for all the technical support in the laboratory. I would also like to thank all the colleagues of my workgroup and building 06.1, especially Daniel Weymann and Andreas Lücke, just to name a few. A special thank to my office mates Shurong Liu and Juliana Gomes for the support and the good times.

I wish to thank Joachim Mohn and Benjamin Wolf for welcoming me at EMPA in Switzerland and for their hospitality making my visit to Switzerland personally and scientifically a highly successful collaboration. Finally, I would like to thank my family and friends for the constant and manifold support aside from work, for all their confidence they put in me, and for all their encouragement.

Abstract

Soils are a major source of nitrogen (N) trace gases, especially of nitrous oxide (N_2O) and nitric oxide (NO). The two microbial processes nitrification and denitrification are considered the major contributors to these emissions. While microbial denitrification has long been identified as a source of N trace gases under reducing conditions, N trace gas formation under aerobic conditions is far from being completely understood. Several abiotic reactions involving the nitrification intermediates hydroxylamine (NH_2OH) and nitrite (NO_2^-) have been identified leading to N_2O and NO emissions, but are neglected in most current studies. Further, there is a potential abiotic sink function of soils for N_2O via photochemical destruction. For better N trace gas mitigation strategies, the identification of the major source and sink processes and their role in the global N cycle is vital.

Prior to the experimental work, this thesis reviews information about the role of abiotic processes in the formation of N trace gases from the few available studies reporting on abiotic emissions. It merges the gained information into a new conceptual model explaining the formation of the N trace gases N_2O , NO, as well as gaseous nitrous acid (HONO) by coupled biotic–abiotic reaction mechanisms. The relevant reactions are: the self-decomposition of NO_2^- , reactions of NO_2^- with reduced metal cations, the nitrosation of soil organic matter (SOM) by NO_2^- , the comproportionation of NO_2^- and NH_2OH , and the oxidation of NH_2OH by manganese or iron. While reactions involving NO_2^- have been shown to produce primarily NO, reactions of NH_2OH are known to lead to N_2O as their main product.

In soils it is difficult to discriminate between biological and abiotic processes. Here, stable isotope techniques are a promising tool to give more insight into the production processes. Especially the site preference (SP) of ^{15}N in N_2O can help to source partition between processes. Experiments have been designed to study the abiotic formation of N_2O from NH_2OH in solutions and in different non-sterile and sterile soils from forest, grassland, and cropland. While organic forest soils showed hardly any N_2O formation upon NH_2OH addition, an immediate and strong formation of N_2O was observed in cropland soil, also in sterilized samples. A correlation analysis revealed a potential positive relationship of the NH_2OH -induced N_2O formation with soil pH and manganese content, construing an effect of pH on NH_2OH stability and of manganese acting as an oxidation agent for NH_2OH . A negative correlation between abiotic N_2O formation and C/N ratio was found that could indicate a possible competitive reaction of NH_2OH with functional groups of SOM. All abiotic N_2O production pathways showed a characteristic, high SP unaffected by reaction conditions.

For studying a photochemical decomposition mechanism of N_2O that could potentially act as a sink for N_2O in hot desert regions of the world, experiments simulating such conditions have been conducted using a laser absorption spectrometer coupled to a flow-through reaction chamber in a

closed loop mode. However, N_2O decomposition could not be observed, at least not within the short timeframe and the conditions of the experiments, and thus photochemical destruction on hot siliceous surfaces could not be verified.

This thesis suggests a coupled biotic–abiotic production of N_2O during nitrification, which could be initialized by a leakage of the nitrification intermediate NH_2OH from nitrifying microorganisms with subsequent reaction in the soil matrix. This mechanism could be significant in agroecosystems showing high nitrification rates upon fertilizer application and commonly having a low organic matter content and a near-neutral pH, but further research is needed to quantify the contribution of abiotic processes to total N_2O emissions.

Zusammenfassung

Böden sind eine Hauptquelle für N-Spurengase, vor allem für Distickstoffmonoxid (Lachgas, N_2O) und Stickstoffmonoxid (NO). Die beiden mikrobiellen Prozesse Nitrifikation und Denitrifikation werden dabei als Hauptverursacher dieser Emissionen angesehen. Während die mikrobielle Denitrifikation seit langem als Quelle für N-Spurengase unter reduzierenden Bedingungen bekannt ist, ist die N-Spurengasbildung unter aeroben Bedingungen weitgehend unverstanden. Von mehreren abiotischen Reaktionen der Zwischenprodukte der Nitrifikation, Hydroxylamin (NH_2OH) und Nitrit (NO_2^-), ist bekannt, dass sie zu N-Spurengasemissionen führen. In den meisten aktuellen Studien zur N-Spurengasbildung werden diese aber nicht berücksichtigt. Des Weiteren wurde in der Literatur von der Möglichkeit einer abiotischen N_2O -Senke durch photochemische Zersetzung auf heißen Bodenoberflächen berichtet. Für bessere N-Spurengasminimierungsstrategien ist es erforderlich, die wichtigsten Quellen und Senken dieser Spurengase und ihre Rolle im globalen N-Kreislauf zu verstehen.

Vor der experimentellen Arbeit werden in dieser Dissertation die verfügbaren Informationen über die Rolle abiotischer Prozesse bei der Bildung von N-Spurengasen aus den wenigen Studien zu dieser Thematik zusammengefasst und zu einem neuen konzeptionellen Modell zusammengeführt, welches die Bildung der N-Spurengase N_2O und NO sowie gasförmiger salpetriger Säure (HONO) durch gekoppelte biologisch-chemische Reaktionsmechanismen erklärt. Relevante Prozesse sind: die Selbstzersetzung von NO_2^- , Reaktionen von NO_2^- mit reduzierten Metallkationen, die Nitrosierung von organischer Bodensubstanz (SOM) durch NO_2^- , die Komproportionierung zwischen NO_2^- und NH_2OH und die Oxidation von NH_2OH durch Mangan oder Eisen. Während Reaktionen, an denen nur NO_2^- beteiligt ist, primär NO produzieren, ist N_2O das Hauptprodukt von Reaktionen mit NH_2OH .

In Böden ist es schwierig, zwischen biologischen und abiotischen Prozessen zu unterscheiden. Hierbei sind stabile Isotopentechniken ein vielversprechendes Werkzeug, um mehr Einblick in die Entstehungsprozesse von N-Spurengasen zu erlangen. Besonders die positionsspezifische Häufigkeit von ^{15}N im N_2O -Molekül könnte bei der Quantifizierung der Quellstärke unterschiedlicher Prozesse helfen. Es wurden Experimente durchgeführt, um die abiotische N_2O -Bildung aus NH_2OH in Lösungen und nicht sterilen sowie sterilen Böden aus Wald, Grünland und Ackerland zu untersuchen. Während organische Waldböden kaum N_2O -Bildung nach Zugabe von NH_2OH zeigten, wurde eine sofortige, starke Bildung von N_2O im untersuchten Ackerboden auch in sterilen Proben beobachtet. Eine Korrelationsanalyse zeigte einen positiven Einfluss des Boden-pH-Wertes und des Mangangehaltes auf die NH_2OH -bürtige N_2O -Bildung, was einen Einfluss des pH-Werts auf die Stabilität von NH_2OH und die Wirkung von Mangan als Oxidationsmittel für NH_2OH nahelegt. Eine negative Korrelation wurde zwischen der abiotischen Bildung von N_2O und dem C/N-

Verhältnis gefunden, die auf eine mögliche Konkurrenzreaktion von NH_2OH mit funktionellen Gruppen der SOM hindeutet. Alle abiotischen N_2O -Bildungsprozesse zeigten eine von den Reaktionsbedingungen unabhängige, hohe positive Positionsabhängigkeit von ^{15}N innerhalb der gebildeten N_2O -Moleküle.

Um einen photochemischen Abbaumechanismus für N_2O , der in heißen Wüstenregionen der Erde als potenzielle Senke für N_2O dienen könnte, zu untersuchen, wurden Experimente, die solche Bedingungen simulierten, mit Hilfe eines Laserabsorptionsspektrometers, welches in einem geschlossenen Kreislauf mit einer Durchflussreaktionskammer gekoppelt war, durchgeführt. Allerdings konnte im zeitlich begrenzten Rahmen und unter den gewählten Versuchsbedingungen kein signifikanter Abbau von N_2O beobachtet werden.

Diese Dissertation schlägt eine gekoppelte biotisch-abiotische Produktion von N_2O während der Nitrifikation vor, die durch das Austreten des Nitrifikationszwischenprodukts NH_2OH mit anschließender Reaktion in der Bodenmatrix entsteht. Dieser Mechanismus könnte in Agrarökosystemen relevant sein, welche hohe Nitrifikationsraten nach Düngung aufzeigen und gewöhnlich einen geringen organischen Kohlenstoffanteil und einen weitgehend neutralen pH-Wert des Bodens aufweisen. Allerdings sind weitere Untersuchungen nötig, um den Anteil abiotischer Prozesse an den N-Spurengasemissionen zu quantifizieren.

List of Figures

2.1	Schematic of chemical reactions of nitrification intermediates leading to N ₂ O formation (SOM = soil organic matter).....	30
3.1	Schematic representation of the laboratory setup for the determination of abiotic N ₂ O production with dynamic flow-through chambers coupled to a quantum cascade laser absorption spectrometer (QCLAS).	36
3.2	Mixing ratios of N ₂ O (red line) and NO (blue line) produced by the abiotic reaction between 1 mM NH ₂ OH and 1 mM NO ₂ ⁻ buffered (citrate buffer) (A) at pH 3, (B) at pH 4, (C) at pH 5, and (D) unbuffered (pH 3.4) with the addition of 2 mM Fe ³⁺ ; All values are 1 Hz data.	39
3.3	Mixing ratios of N ₂ O (red line) and NO (blue line) produced by the abiotic reaction between 1 mM NH ₂ OH and 2 mM Fe ³⁺ , (A) unbuffered at pH 3.4 and (B) buffered (Tris-maleate) at pH 6; All values are 1 Hz data.	40
3.4	Results of the isotopic analysis of N ₂ O produced by the abiotic reaction between 1 mM NH ₂ OH and 1 mM NO ₂ ⁻ , buffered at pH 4 (citrate-phosphate buffer): N ₂ O mixing ratio in ppm (A), δ ¹⁵ N ^{bulk} , δ ¹⁵ N ^α , and δ ¹⁵ N ^β of N ₂ O (B), δ ¹⁸ O of N ₂ O (C), and the N ₂ O site preference (SP) (D); All values are 1 Hz data, red lines show the 60 s moving average.	42
3.5	Results of the isotopic analysis of N ₂ O produced by the abiotic reaction between 1 mM NH ₂ OH and 5 mM Fe(III) buffered at pH 5 (Tris-maleate buffer): N ₂ O mixing ratio in ppm (A), δ ¹⁵ N ^{bulk} , δ ¹⁵ N ^α , and δ ¹⁵ N ^β of N ₂ O (B), δ ¹⁸ O of N ₂ O (C), and the N ₂ O site preference (SP) (D); All values are 1 Hz data, red lines show the 60 s moving average.	42
3.6	Results of the isotopic analysis of N ₂ O produced by abiotic autoxidation of 1 mM NH ₂ OH catalyzed by 0.1 mM Cu(II) buffered at pH 8 (Tris-maleate buffer): N ₂ O mixing ratio in ppm (A), δ ¹⁵ N ^{bulk} , δ ¹⁵ N ^α , and δ ¹⁵ N ^β of N ₂ O (B), δ ¹⁸ O of N ₂ O (C), and the N ₂ O site preference (SP) (D); All values are 1 Hz data, red lines show the 60 s moving average.	43
3.7	Relationship between all 1-min average δ ¹⁵ N ^{bulk} and δ ¹⁸ O values of the produced N ₂ O of all experiments.....	44
4.1	N ₂ O emission rates in ng N per g soil from six different non-sterile soil samples after the addition of deionized H ₂ O or NH ₂ OH solution (5 nmol) in 6-h incubation experiments. Samples of ambient air were measured and subtracted as backgrounds from the results. Error bars represent the SD of three replicates. Lower case letters indicate significant differences between different treatments at one site, capital letters between the different sites within one treatment (α < 0.05).	60
4.2	N ₂ O emission rates in ng N per g soil from six different non-sterile and sterilized soil samples after the addition of NH ₂ OH solution (5 nmol) in 6-h incubation experiments. Replicates with the addition of deionized H ₂ O were used as backgrounds and subtracted from the results. Error bars represent the SD of three replicates. Lower case letters indicate significant differences between different treatments at one site, capital letters between different sites within one treatment (α < 0.05).	61

4.3	N ₂ O emission rates in ng N per g soil from six different non-sterile and sterilized soil samples after the addition of two different amounts of NH ₂ OH (5 and 10 nmol) in 6-h incubation experiments. Replicates with the addition of deionized H ₂ O were used as backgrounds and subtracted from the results. Error bars represent the SD of three replicates. Lower case letters indicate significant differences between different treatments at one site, capital letters between the different sites within one treatment ($\alpha < 0.05$).	62
4.4	N ₂ O mixing ratios in ppb measured at a temporal resolution of 1 Hz emitted from different soils after the addition of NH ₂ OH solution (5 μ mol): (A) from non-sterile and sterile cropland soil, (B) from non-sterile and sterile grassland soil, (C) from the three non-sterile coniferous forest soil layers, and (D) non-sterile deciduous forest soil.	63
4.5	N ₂ O mixing ratios in ppb measured at a temporal resolution of 1 Hz emitted from sterile (autoclaved) cropland soil after the addition of NH ₂ OH solution (5 μ mol) at different temperatures from 10 to 50 °C.	64
5.1	Schematic representation of the laboratory setup for the detection of photochemical N ₂ O decomposition over a hot and dry sand surface with a dynamic flow-through chamber coupled to a quantum cascade laser absorption spectrometer (QCLAS).	75
5.2	Nitrous oxide (N ₂ O) mixing ratios in ppb over time at a temporal resolution of 1 Hz in a closed loop experiments with simulated daytime conditions in a dynamic flow-through reaction chamber filled about half-full with sand and irradiated with ultraviolet (UV) and infrared (IR) light. The system was flushed with pressurized air with 281 ppb N ₂ O (A) and with a 500 ppb N ₂ O reference gas (B) prior to the experiment.	76
5.3	Nitrous oxide (N ₂ O) mixing ratios in ppb and water vapor (H ₂ O) mixing ratios in ppm over time at a temporal resolution of 1 Hz in a closed loop experiment with a simulated diurnal day–night–day cycle in a dynamic flow-through reaction chamber filled about half-full with sand and irradiated with ultraviolet (UV) and infrared (IR) light during daytime conditions. The system was flushed with pressurized air (297 ppb N ₂ O) prior to the experiment.	77
5.4	Nitrous oxide (N ₂ O) mixing ratios in ppb and water vapor (H ₂ O) mixing ratios in ppm over time at a temporal resolution of 1 Hz in a closed loop experiments with simulated daytime conditions in a dynamic flow-through reaction chamber filled about half-full with sand mixed with 2.5% ferric oxide (Fe ₂ O ₃) and manganese oxide 0.25% (MnO ₂) and irradiated with ultraviolet (UV) and infrared (IR) light. The system was flushed with pressurized air (225 ppb N ₂ O) prior to the experiment.	78

List of Tables

3.1	Overview of the experiments, experimental conditions, and relevant parameters.	35
3.2	Summary of the results for the studied abiotic reactions. The uncertainty is given as the standard deviation of the 60-s moving average.....	37
4.1	Overview of the different soil samples and their chemical parameters that were used in this study.	56
4.2	Turnover rate of added $\text{NH}_2\text{OH-N}$ to $\text{N}_2\text{O-N}$, isotopic signatures and ^{15}N site preference (SP) of N_2O emitted after addition of NH_2OH to several soils.	65
4.3	Pearson correlation coefficients of the linear correlation between the N_2O emission rates after the addition of NH_2OH from non-sterile, chloroform-fumigated, and autoclaved soils and several measured soil chemical parameters.....	68

List of abbreviations

Ah	humic mineral topsoil horizon
anamnox	anaerobic ammonium oxidation
AOA	ammonia-oxidizing archaea
AOB	ammonia-oxidizing bacteria
C/N	carbon-to-nitrogen ratio
CH ₄	methane
CO ₂	carbon dioxide
Cu ⁺	cuprous ion
CuSO ₄	copper(II) sulfate
cw-QCL	continuous wave quantum cascade laser
δ	isotope ratio relative to standard isotope ratio
δ ¹⁵ N	isotopic ration of ¹⁵ N relative to a standard
δ ¹⁵ N ^{bulk}	average δ ¹⁵ N of N ₂ O
δ ¹⁵ N ^α	δ ¹⁵ N of the central position of N ₂ O
δ ¹⁵ N ^β	δ ¹⁵ N of the terminal position of N ₂ O
δ ¹⁸ O	isotopic ration of ¹⁸ O relative to a standard
DNRA	dissimilatory nitrate reduction to ammonium
e ⁻	electron
E _A	Arrhenius activation energy
ECD	electron capture detector
Fe ²⁺	ferrous iron
Fe ₂ O ₃	hematite
Fe ³⁺	ferric iron
FeCl ₂	iron(II) chloride
FeCl ₃	iron(III) chloride
Fe ₃ O ₄	magnetite
FeOOH	goethite
H ⁺	proton
H ₂ O	water
HNO	nitroxyl
HNO ₂	nitrous acid
HNO ₃	nitric acid
HONNOH	hyponitrous acid
HONO	nitrous acid gas
IR	infrared

IRMS	isotope ratio mass spectrometer
L	litter layer
MFC	mass flow controller
Mn ²⁺	manganous ion
MnO	manganese(II) oxide
MnO ₂	manganese(IV) dioxide
<i>m/z</i>	mass-to-charge ratio
N ₂	nitrogen gas
NaNO ₂	sodium nitrite
NH ₂ OH	hydroxylamine
NH ₂ OH–HCl	hydroxylamine hydrochloride
NH ₃	ammonia
NH ₃ OH ⁺	protonated hydroxylamine
NH ₄ ⁺	ammonium
NIE	net isotope effect
N ₂ O	nitrous oxide
NO	nitric oxide
NO ⁺	nitrosonium cation
NO ₂ ⁻	nitrite
NO ₃ ⁻	nitrate
NOB	nitrite-oxidizing bacteria
O ₂	oxygen gas
Oh	humic topsoil horizon
⁻ ONNO ⁻	hyponitrite
p	pressure
pK _a	acid dissociation constant
QCLAS	quantum cascade laser absorption spectrometer
R ¹ R ² CO	carbonyl group
R ¹ R ² CNOH	oxime group
Sn ²⁺	stannous ion
SOM	soil organic matter
SP	site preference
T	temperature
UV	ultraviolet
VSMOW	Vienna Standard Mean Ocean Water
WHC	water holding capacity

Chapter 1

Introduction

1.1. Rationale

Nitrogen (N) is a key component of all living organisms, but the vast majority of the Earth's N, bound as diatomic nitrogen (N_2) and making up approximately 78% of the Earth's atmosphere, is unavailable to most organisms (Galloway et al., 2004). Only few species can use N_2 and transform it into reactive N that is available to plants and animals, thus most natural ecosystems are N-limited, although evolution developed adaptive mechanisms for an efficient N use. Before the industrial revolution, the conversion of N_2 into reactive N was in equilibrium with losses of reactive N back to N_2 , until the invention of the Haber-Bosch process led to an uncoupling of this equilibrium (Ciais et al., 2013). Since then, the amount of anthropogenically produced reactive N has been much higher than the amount returned back to the atmosphere as N_2 , and is still increasing due to increasing use of artificial fertilizer, enabling humankind to greatly increase food production to feed the growing global population (Gruber and Galloway, 2008). However, this has led to a lot of environmental problems from eutrophication of ecosystems to acidification, as well as to the production of environmental and climate-relevant N trace gases.

Soils are a major source of nitrous oxide (N_2O), nitric oxide (NO), and N_2 , with increasing tendency due to anthropogenic activities (Ciais et al., 2013). While N_2 is an inert gas and the major component of the Earth's atmosphere, NO is a highly reactive trace gas with great environmental impact. NO and its oxidation product NO_2 , subsumed as NO_x , catalyze the formation of tropospheric ozone in the presence of volatile organic compounds (Crutzen, 1979). NO has negative impacts on human health as well as plant productivity. Plant damage from tropospheric ozone is believed to be responsible for more than \$2 billion per year in crop losses in the USA alone (Delucchi et al., 1996). Natural soil and agricultural NO_x emissions are estimated at 7.3 and 3.7 Tg N yr⁻¹, respectively, combining to 23% of total global emissions (Ciais et al., 2013). N_2O , on the other hand, is contributing significantly to stratospheric ozone destruction (Ravishankara et al., 2009) and is the fourth-most important anthropogenic greenhouse gas (Davidson, 2009), almost 300 times more potent than carbon dioxide (CO_2) and still about 12 times more potent than methane (CH_4) in a time frame of 100 years (Ciais et al., 2013). The atmospheric concentration of N_2O increased from a pre-industrial value of 270 ppb to 325 ppb in 2012 at a rate of about 0.80 ppb yr⁻¹ over the last decade (WMO, 2013). The global N_2O source strength is still highly uncertain, which is reflected in the high uncertainty of the estimate given by the IPCC in 2013, ranging from 8.1–30.7 Tg N yr⁻¹ (Ciais et al., 2013). With an estimated 50–60% of global N_2O emissions, soils – especially agricultural soils – have been identified as the major source of this potent greenhouse gas (USEPA, 2010). A globally growing demand for food and increasing use of N fertilizer will further increase emissions (Wuebbles, 2009), although new approaches for better agricultural efficiency and mitigation are being developed (Smith et al., 2007).

Microbial nitrification and denitrification are widely accepted as the major sources of these N gas emissions from soils (Ciais et al., 2013). NO and N₂O release during both processes has been described by Firestone and Davidson (1989) in their conceptual ‘hole-in-the-pipe’ model, but N trace gas production in soils, especially during nitrification, is far from being completely understood. The model attributes NO and N₂O emissions from soils during nitrification and denitrification to leaks in the N transformation from ammonium (NH₄⁺) via hydroxylamine (NH₂OH) and nitrite (NO₂⁻) to nitrate (NO₃⁻), and to the incomplete sequential reduction of NO₃⁻ via NO₂⁻, NO, and N₂O to N₂. However, this model is over-simplistic, as it is known that there are a variety of processes and metabolic pathways involved in soil N trace gas production. Because denitrification can both produce and consume NO and N₂O, an imbalance between NO or N₂O formation and reduction, depending on enzyme regulation, can make denitrifying bacteria net N trace gas producers or consumers. The fact that soils can, at least temporarily, function as significant N₂O sinks has been reported recently (Chapuis-Lardy et al., 2007; Goldberg and Gebauer, 2009).

Apart from soil bacteria, fungi can also denitrify, but largely lack N₂O reductase and therefore produce N₂O (Laughlin and Stevens, 2002). Fungi are also involved in a hybrid reaction, called co-denitrification, in which inorganic and organic N precursors lead to NO or N₂O formation (Spott et al., 2011). Nitrifying bacteria produce N₂O as a side product during the oxidation of NH₂OH, but can also reduce nitrite under oxygen-limiting conditions or at elevated nitrite concentrations in a process similar to denitrification known as nitrifier denitrification (Poth and Focht, 1985; Wrage et al., 2001). There are more alternative processes potentially involved in N trace gas formation in soils, such as heterotrophic nitrification, dissimilatory nitrate reduction to ammonium (DNRA), and nitrification by archaea, but besides these various, widely unexplored and partially not very well understood microbial processes there are also several abiotic pathways that are known for years but are widely neglected in most current studies (Bremner, 1997; Butterbach-Bahl et al., 2013; Santoro et al., 2011; Stevens et al., 1998; Yamulki et al., 1997). Those abiotic N trace gas formation pathways include (i) chemodenitrification, i.e., the decomposition of soil NO₂⁻ with NO as main product, but N₂O as minor product (van Cleemput and Samater, 1996), (ii) the abiotic decomposition of ammonium nitrate on reactive surfaces in the presence of light (Rubasinghege et al., 2011), and (iii) the oxidation of the nitrification intermediate NH₂OH that can be oxidized by several soil constituents to form N₂O (Bremner, 1997).

The occurrence of non-enzymatic NO₂⁻ decomposition associated with gaseous N losses was proposed by Clark (1962) and referred to as chemodenitrification. Since then, the role of NO₂⁻ decomposition in N trace gas formation has been reviewed occasionally (Chalk and Smith, 1983; Nelson, 1982; van Cleemput and Samater, 1996). However, those reviews did not try to link abiotic mechanisms to other known biotic soil processes that could potentially deliver the substrate for the abiotic N trace gas formation. Until now, it has never been attempted to merge the various biotic and abiot-

ic N transformation processes into a conceptual model explaining N trace gas formation in soils. A potential mechanism for these abiotic reactions could be a leakage of biologically produced NH_2OH and NO_2^- out of the respective microorganisms into the soil matrix, where they could react with oxidizing (in case of NH_2OH) or reducing (in case of NO_2^-) compounds. Alternatively, both substrates could react with each other to yield N_2O , a reaction which has been shown to lead to N_2O formation (van Cleemput and Samater, 1996). These reactions could easily be overlooked because of the simultaneous activity of biological and abiotic N_2O source processes in close vicinity in soils. While reactions involving NO_2^- are more commonly associated with NO formation, another nitrification intermediate, NH_2OH , is linked with the formation of N_2O (Bremner, 1997), as it is highly reactive and can undergo reactions with several soil constituents to form N_2O .

NO_2^- occurs in soil as an intermediate product of microbial nitrification and denitrification, and early studies used the chemical decomposition of NO_2^- to explain gaseous losses of fertilizer N from agricultural systems (Nelson and Bremner, 1970a). In their review on chemodenitrification, Chalk and Smith (1983) presented abiotic mechanisms leading to gaseous N losses, such as the self-decomposition of nitrous acid (HNO_2 ; the protonated form of NO_2^-), the reaction of HNO_2 with amino compounds and NH_4^+ , the reaction of HNO_2 with soil organic matter (SOM) and the reduction of NO_2^- by metal ions. Although NO_2^- generally does not accumulate in soils under natural conditions due to its reactive character (Robertson and Groffman, 2007), there are situations, especially after fertilizer application, in which NO_2^- can accumulate to a greater or lesser extent (Gelfand and Yakir, 2008). Therefore, N trace gas formation from abiotic reactions of NO_2^- have been considered in studies occasionally (e.g., Cheng et al., 2004; Ding et al., 2010; Kesik et al., 2006; Li et al., 2000; Yamulki et al., 1997). NO_2^- has long been considered to be the key intermediate for abiotic N trace gas formation (Venterea, 2007), although NH_2OH plays a fundamental role in the formation particularly of N_2O (Bremner et al., 1980). The fact that NH_2OH is even more short-lived than NO_2^- and was for a long time non-detectable in soils, has led an omission of these NH_2OH -induced N trace gas formation in favor of microbial pathways. Non-detection is usually explained by the highly reactive character of NH_2OH (Moews and Audrieth, 1959), but another factor that led to this omission was that NH_2OH is generally not a free intermediate of nitrification as NO_2^- , i.e., NH_2OH is generally not assumed to be released by nitrifying microorganisms (De Boer and Kowalchuk, 2001), although a release has been reported (Schmidt et al., 2004b; Stüven et al., 1992). Since NH_2OH can be oxidized by several soil constituents to form N_2O (Bremner et al., 1980), it can be hypothesized that an underestimation of the importance of NH_2OH led consequently to an underestimation of abiotic N trace gas formation, especially of N_2O . Additionally, other novel microbial soil processes as DNRA or the anaerobic ammonium oxidation (anammox) could be potential sources of NH_2OH besides nitrification.

Despite the general knowledge about abiotic N trace gas formation, little is known about the magnitude of these chemical processes in the global N cycle. Especially under field conditions it is difficult to identify the processes responsible for the formation of the respective N gases, as diverse biotic and abiotic processes act simultaneously (Venterea, 2007). A better understanding of these abiotic processes and their contributions to NO, N₂O, and N₂ fluxes is needed (Gårdenäs et al., 2011), as especially changing climatic conditions, such as increasing frequency and/or intensity of drying/rewetting or freeze/thaw cycles, might increase the importance of abiotic reactions for soil N trace gas formation, e.g., NO₂⁻ accumulation with subsequent decomposition. This knowledge could improve modeling of ecosystem N cycling and constraining atmospheric greenhouse gas budgets, and will help to quantify the feedback to global climate change and other environmental problems, such as the destruction of stratospheric ozone by N₂O or tropospheric ozone formation or acid deposition by NO (Ciais et al., 2013; Crutzen, 1979; Ravishankara et al., 2009).

1.2. Objectives and outline of the thesis

The overall aim of this dissertation was to characterize abiotic N trace gas formation, processes that have been known for years but which are widely neglected in current studies. This could be due to the factors discussed above, so that it can be hypothesized that abiotic N trace gas formation is overlooked in favor of other unclear production mechanisms. This thesis aimed to clarify the role of these abiotic processes in soils. To achieve this, the existing knowledge on abiotic N trace gas formation from soils was gathered in the first instance. This review about the chemical N trace gas formation can be found in chapter two. It summarizes the over the last 50 to 60 years infrequently occurring and, in a lot of cases, overlooked studies reporting on abiotic N trace gas formation in soils and merges them into one conceptual model, revisiting the “hole-in-the-pipe” model and explaining abiotic formation of N₂O, NO and gaseous nitrous acid (HONO). Further, the second chapter emphasizes the coupling between biotic nitrification and abiotic mechanisms leading to N trace gas formation. Based on this hypothesis of a coupled biotic–abiotic N trace gas formation during nitrification, experiments were developed to demonstrate the relevance of these abiotic reactions in soils.

Because of the simultaneous occurrence of biotic and abiotic trace gas formation processes in soils, experiments were created helping to improve source partitioning the different N₂O formation processes. Stable isotopes, and especially the site-specific position of ¹⁵N inside the N₂O molecule (site preference, SP), are considered promising tools allowing to differentiate between the different N₂O production and consumption processes. The SP is defined as the difference in ¹⁵N isotope signatures ($\delta^{15}\text{N}$) between the central (N^a) and the terminal (N^b) positions of the asymmetric linear N₂O molecule (Toyoda and Yoshida, 1999). While the $\delta^{15}\text{N}$ in N₂O produced in soils is supposed

to be controlled by the isotopic signature of the substrate, the SP is assumed to represent the production process (Sutka et al., 2006). Lately, the site-specific isotopic signature of N_2O from distinct microbial pathways has been studied in pure microbial populations as well as in mixed culture systems (Bol et al., 2003; Frame and Casciotti, 2010; Opdyke et al., 2009; Sutka et al., 2006; Sutka et al., 2003; Toyoda et al., 2005; Well et al., 2006; Wunderlin et al., 2013). It has been shown, that the ^{15}N SP in N_2O can be used to differentiate between the microbial formation processes nitrification and denitrification, albeit with a considerable uncertainty (Ostrom and Ostrom, 2011). However, isotopic signatures are not known for all processes, and for some known processes signatures vary over large ranges, making source partitioning using stable isotopes challenging. The study of the site-specific signature of abiotically produced N_2O could be another piece in the puzzle of source partitioning. As the SP is supposed to reflect the N_2O production mechanism, it can be hypothesized that if a distinct SP for abiotic N_2O production was found, it could be used to distinguish between microbial and abiotic N_2O production in soils and by this serve as a proof of abiotic N_2O formation in soils. However, if previously observed N_2O formation during nitrification had been wrongly assigned to microbial production, but is actually of abiotic origin, it could be hypothesized that the SP for abiotic N_2O production could be the same as observed for microbial processes. To answer these questions, first experiments on possible abiotic reactions being discussed in literature to contribute to N trace gas formation from soils involving the nitrification intermediates NH_2OH and/or NO_2^- in combination with other soils constituents, were tested in aqueous solution for their production of NO and N_2O using chemiluminescence detection and laser adsorption spectrometry, respectively. Based on these results, experiments have been developed to determine the ^{15}N site-specific isotopic signature of abiotically produced N_2O from identified reaction mechanisms in solutions. For this, the latest laser absorption spectroscopy was used to achieve high precision data in virtually real-time at a temporal resolution of 1 Hz. This not only allowed studying the site-specific isotopic signature of abiotically produced N_2O for different abiotic reactions under various conditions, but also gave insight into isotopic fractionation over time and the kinetics of the reactions. These results are presented in chapter three. The isotopic signatures have been discussed with regard to a possible source determination and have been compared in this context with isotopic signatures of N_2O produced by microbial soil processes.

As the first experiments in this thesis were designed to validate potential N_2O formation processes from nitrification intermediates, to quantify N_2O formation under different conditions, and to find a distinct SP of abiotically produced N_2O in solutions, experiments presented in chapter four were designed to provide evidence that these abiotic processes could also occur in soils. To find evidence for abiotic N_2O production from the nitrification intermediate NH_2OH in soils, incubation experiments with live and sterilized soils were conducted. These experiments were designed to show: (i) the potential of soils to oxidize NH_2OH abiotically, (ii) the influence of soil parameters

on NH_2OH oxidation potential, (iii) the kinetics of NH_2OH oxidation reactions, and (iv) the isotopic signature of abiotically produced N_2O . It is known for years that transition metals, primarily iron and manganese, can oxidize NH_2OH , leading to the formation of N_2O (Bremner et al., 1980). As iron and manganese are to a lesser or greater extent constituents of most soils, it can be hypothesized that soils have a potential to oxidize NH_2OH to N_2O , depending on their content of transition metals and/or maybe other unknown constituents. Other potential influential soil parameters can be hypothesized to be soil pH, as it controls the stability of NH_2OH and kinetics of the reactions, and also SOM content, as incorporation of NH_2OH into SOM has been observed (Bremner et al., 1980; Porter, 1969) that could act as a reaction competing with the oxidation of NH_2OH . Thus, it could be assumed that high SOM contents counteract NH_2OH oxidation to N_2O . Compared to microbial reactions, abiotic N_2O production is supposedly very fast and proceeds immediately upon the availability of the substrate. After the addition of NH_2OH , a peak-like formation of gaseous products could be expected.

The isotopic signatures of N_2O from different soil processes have been shown to be dependent on the substrate, but the SP for N_2O produced during nitrification was found to be in a high positive range, independent of the substrate (Decock and Six, 2013; Sutka et al., 2006). As it was presumed that the SP depends on the production process, particularly on the last intermediate step in the formation of N_2O (Toyoda et al., 2002), it can be expected that the SP of abiotically produced N_2O from the oxidation of NH_2OH will be in a similar range. To validate the hypotheses above, the laboratory incubation experiment in this study used soils covering a wide range of land use types (cropland, grassland, and forest). Soil incubations were conducted at conditions favorable for nitrification. Incubations with and without the addition of NH_2OH solution, as well as with non-sterile and sterile soils have been conducted using gas chromatography for N_2O quantification. For the analysis of the kinetics of NH_2OH -induced N_2O formation N_2O mixing ratios were quantified online at a high temporal resolution using quantum cascade laser absorption spectroscopy. Furthermore, isotope ratio mass spectrometry was used to analyze the isotopic signatures (i.e., $\delta^{15}\text{N}$, $\delta^{18}\text{O}$, and SP) of abiotically formed N_2O . All results will be discussed regarding a potential abiotic formation of N_2O in soils and soil parameters that could have an influence on the production. This knowledge can help to verify the hypothesized abiotic N_2O production mechanisms and help to understand the influencing soil parameters.

The very long estimated atmospheric lifetime of N_2O of about 120 years is mainly due to the lack of significant N_2O sinks in the troposphere (Ciais et al., 2013). Although it has been shown lately that soils, at least temporarily, can act as N_2O sinks (Berger et al., 2013; Chapuis-Lardy et al., 2007; Goldberg and Gebauer, 2009), these sinks could be of importance on a local scale, but at a global scale soils remain net producers of N_2O at a still increasing rate due to agricultural intensification. The only known significant sink for N_2O is the photochemical or oxidative destruction in

the stratosphere, by which only less than 1% of the atmospheric N_2O is annually removed (Montzka et al., 2011). The knowledge of additional sink processes in the troposphere would therefore greatly enhance our ability to constrain the global N_2O budget.

Photolysis could also play a role in N_2O production and destruction in the troposphere. Recently, a photochemical pathway for the production of N_2O has been proposed by Rubasinghege et al. (2011). It describes the abiotic N_2O production from ammonium nitrate fertilizer via photolysis at the surface in the presence of light at 298 K and some air humidity, a mechanism that has not been considered in previous N_2O budgets. Lately, this process has also been used to explain the abiotic N_2O formation from a hypersaline pond in Antarctica (Peters et al., 2014). Besides these photochemical processes leading to N_2O production, the photochemical destruction of N_2O had also been proposed in the past. The possibility of large desert areas as a possible tropospheric sink for N_2O was first suggested by Junge et al. (1971), who found lower concentrations of N_2O during a cruise in the Atlantic Ocean associated with air masses of West African origin. The findings of Schütz et al. (1970) at a mountain observatory on the island of Tenerife, that is almost permanently in the Saharan air layer, gave further evidence for this process. The authors found that the concentration of N_2O at the mountain observatory (260 ppb) was significantly lower than compared to 320 ppb N_2O at the sea level station on the island that was not in the Saharan air layer. There was no explanation for this, until Rebbert and Ausloos (1978) suggested the photochemical destruction of N_2O as a possible mechanism. The authors showed that N_2O can be adsorbed on very dry sand surfaces and subsequently be decomposed by photons of sunlight that N_2O cannot absorb in the gas phase. Although it is known that N_2O can be photochemically decomposed at elevated temperatures, Rebbert and Ausloos (1978) showed that dry particulate matter in the troposphere may be responsible for the decomposition of N_2O . The reaction was shown to proceed at 23 °C with light at wavelengths greater than 280 nm, with decreasing rate of photolysis at increasing wavelength. The addition of water vapor to the system resulted in a dramatic decrease of photolysis. It was predicted, that dry desert sands may act as sinks for atmospheric N_2O and that they might be able to significantly reduce the effect on the stratospheric ozone layer as has been predicted on the basis of very long tropospheric lifetimes (Pierotti et al., 1978). Therefore, final experiments were conducted to study a possible photochemical N_2O decomposition mechanism over hot and dry surfaces, conditions as found in hot desert areas of the world. For this, laboratory experiments using a flow-through reaction chamber in a closed loop connected to a laser absorption spectrometer were set up. This allowed for an online monitoring of N_2O mixing ratios over quartz sand as a reactive surface at hot and dry conditions and at high ultraviolet (UV) light intensity. If it was found to be relevant, this potential photochemical destruction of N_2O could be a mechanism, which is currently not considered in global N_2O budget calculations.

Chapter 2

A review of chemical nitrogen trace gas formation reactions of nitrification intermediates in soils

Based on:

Heil, J., Vereecken, H. and Brüggemann, N. (2015) A review of chemical reactions of nitrification intermediates and their role in nitrogen cycling and nitrogen trace gas formation in soils. *Euro. J. Soil Sci.* (accepted)

2.1. The role of nitrification intermediates in abiotic nitrogen trace gas formation

NH_2OH and NO_2^- are intermediates of nitrification, the biological oxidation of ammonia (NH_3) to NO_3^- . The process is carried out by two groups of microorganisms: the first step, the conversion from NH_3 to NO_2^- by ammonia-oxidizing bacteria (AOB), the second step, the oxidation of NO_2^- to NO_3^- , by nitrite-oxidizing bacteria (NOB) (Bock et al., 1986). Taxonomically the two groups belong to one family, the *Nitrobacteraceae* (Robertson and Groffman, 2007). *Nitrosomonas europaea* is the best studied but not necessarily most common AOB (Chain et al., 2003). *Nitrobacter winogradskyi* is the best studied representative of NOB (Bock et al., 1986). NH_2OH is the first of several intermediates that are formed during nitrification. The enzyme ammonia monooxygenase catalyzes the oxidation of NH_3 to NH_2OH ; two electrons are required for the reduction of one atom of O_2 to water (Robertson and Groffman, 2007):



Successively, NH_2OH is oxidized to NO_2^- , catalyzed by the enzyme hydroxylamine oxidoreductase:



Two of the four electrons from Equation (2) are returned to the ammonia monooxygenase reaction (1) (Chain et al., 2003). Both enzymes utilized for the oxidation of NH_3 to NO_2^- are found in bacteria of the genus *Nitrosomonas* (Parkes et al., 2007).

NO_2^- is further oxidized by NOB, such as *Nitrobacter*, catalyzed by nitrite oxidoreductase in a one-step reaction to NO_3^- (Bock et al., 1986):



The nitrifying bacteria are chemolithoautotrophic, i.e., they use the chemical energy from nitrification for the fixation of CO_2 as their carbon (C) source. The *Nitrobacteraceae* are aerobic microorganisms, and thus require O_2 (Robertson and Groffman, 2007).

Besides AOB, there are ammonia-oxidizing archaea (AOA) involved in the oxidization of NH_3 . Leininger et al. (2006) found that AOA outnumber AOB in most soils, but their contribution to nitrification cannot be inferred from plain abundance and therefore needs to be assessed. Di et al. (2009), however, assumed that AOA, although being present in great quantity, contributed little to nitrification in N-rich grassland soils. Archaea are better adapted to resource limitations than bacte-

ria, which could give archaea competitive advantages over bacteria in unfavorable conditions, such as low nutrient availability and/or low or high soil pH (Di et al., 2009; Valentine, 2007).

Additionally, a variety of heterotrophic bacteria and fungi can oxidize NH_3 (De Boer and Kowalchuk, 2001). There are two pathways proposed for heterotrophic NH_3 oxidation (Kuenen and Robertson, 1994). In the first, heterotrophic bacteria use similar enzymes as their autotrophic counterparts (Moir et al., 1996). The second pathway seems to be limited to fungi and involves a reaction of N compounds with hydroxyl radicals formed in the presence of hydrogen peroxide and superoxide, which can occur during cell lysis and lignin degradation by fungi (De Boer and Kowalchuk, 2001).

Even though NO_2^- does usually not accumulate in soils under natural conditions (Robertson and Groffman, 2007), it plays a key role in the global N cycle, as it is formed as a free intermediate in both aerobic nitrification and anaerobic denitrification processes (van Cleemput and Baert, 1984). As an anion, NO_2^- is very mobile and constitutes a fundamental link between different N transformation processes in different soils under diverse environmental conditions (Kappelmeyer et al., 2003). It has been expected for a long time that the NO_2^- anion is the key intermediate between the solid or solute and gaseous states of N (Wullstein and Gilmour, 1966). The first nitrification intermediate, NH_2OH , also plays a fundamental role, although it is usually not released by the bacteria into the soil matrix (Bremner et al., 1980). AOB transform NH_3 into NH_2OH , which is then released into the periplasm, where it is oxidized to NO_2^- (De Boer and Kowalchuk, 2001). However, the release of NH_2OH into the surrounding medium had also been reported (Schmidt et al., 2004b; Stüven et al., 1992), and non-detection in soils was explained by the highly reactive character (Moews and Audrieth, 1959). However, only recently a novel, highly sensitive method for the detection of NH_2OH in soils was introduced, with which the authors were able to detect NH_2OH in an acidic forest soil (Liu et al., 2014).

NO_2^- (or in its protonated form HNO_2) and NH_2OH are N compounds potentially involved in abiotic N trace gas emissions from soils (see below). As they are microbially derived, the two nitrification intermediates are only available as reagents for abiotic N trace gas formation with soil microbial activity. This already suggests a tight coupling between biotic and abiotic N transformation processes, with abiotic N trace gas production being initiated by the microbiological generation of NO_2^- and NH_2OH via nitrification and/or denitrification. Venterea (2007) argues that all known biochemical and chemical processes of soil N_2O production involve the reduction of NO_2^- , but studies have shown that the nitrification intermediate NH_2OH in conjunction with – but also in the absence of NO_2^- – is the precursor of abiotic N_2O production, while reactions involving NO_2^- in the absence of NH_2OH tend to produce mostly NO (Bremner et al., 1980; Butler and Gordon, 1986; Nelson, 1978; Spott and Stange, 2011). In a laboratory study, Venterea and Rolston (2000a) showed that gross NO production rates in agricultural soils were highly correlated with HNO_2 con-

centration and not with nitrification rates or N substrate availability, indicating that HNO_2 protonation might be more important than NO_2^- concentration alone.

2.2. Accumulation of NO_2^-

Due to its highly reactive nature, the nitrification intermediate NH_2OH will usually not accumulate in soils (Moews and Audrieth, 1959), but under certain conditions NO_2^- can accumulate in agroecosystems as well as in arid or seasonally arid unmanaged ecosystems (Gelfand and Yakir, 2008). NO_2^- will only accumulate in the soil, when NO_2^- consumption is lower than NO_2^- production (Burns et al., 1996). In most non-agricultural soils, the oxidation of NO_2^- to NO_3^- proceeds faster than the conversion of NH_3 to NO_2^- , therefore NO_2^- is normally not present in concentrations greater than 1 mg N kg^{-1} soil (Chalk and Smith, 1983). Its accumulation in soils is depending on a set of soil characteristics such as soil pH, C and O_2 availability, and even more on agricultural practices, especially when alkaline conditions are promoted (Bezdicsek et al., 1971; Burns et al., 1995; Chalk et al., 1975; Shen et al., 2003; Smith et al., 1997).

2.2.1 Role of soil properties

Under alkaline conditions both AOB and NOB are suppressed, but NOB are usually more sensitive to high pH and salt concentrations than AOB (Shen et al., 2003). The optimum soil pH for nitrification is between 7 and 9, but since the activity of NOB is more strongly inhibited at high soil pH than that of AOB, NO_2^- may accumulate (Chalk et al., 1975). With the discovery of AOA, this classic neutral pH optimum for soil NH_3 oxidation was challenged, as different archaeal as well as bacterial subgroups have been found to fill diverse ecological niches broadening the pH spectrum of nitrification (Nicol et al., 2008).

However, NO_2^- accumulation in soil is not only the resultant of NH_3 oxidation (NO_2^- formation) and NO_2^- oxidation (NO_2^- consumption) during nitrification, but also of NO_3^- reduction (NO_2^- formation) and NO_2^- reduction (NO_2^- consumption) during denitrification. Burns et al. (1996) showed in an experiment with ^{15}N -enriched N pools that both nitrification and denitrification produce NO_2^- simultaneously in the same soil, though nitrification was the more important process for NO_2^- accumulation in that experiment.

Smith et al. (1997) developed a model explaining NO_2^- accumulation in soil. The model describes NO_2^- accumulation as a result of the inhibitory effect of free NH_3 on NOB. The simulation showed that NH_4^+ oxidation was only required to be slightly in excess of NO_2^- oxidation to cause NO_2^- accumulation. Smith et al. (1997) concluded that the main process causing NO_2^- accumulation is nitrification, while denitrification is only of minor importance. Shen et al. (2003) showed the effect

of pH on NO_2^- accumulation in an incubation experiment. They were able to maintain high NO_2^- concentrations in slurries of $\text{pH} > 8$, although NH_4^+ was not detected after several days of incubation any longer. This suggests a low NO_2^- oxidizer activity plus relatively high NO_2^- stability at high pH levels (Shen et al., 2003). Besides high soil pH, low temperatures, low C availability, low soil moisture content, and high levels of NH_4^+ can also be a cause of NO_2^- accumulation (Burns et al., 1996; Christianson and Cho, 1983; van Cleemput and Baert, 1983).

The accumulation of NO_2^- during denitrification is even more complex. The reduction of NO_3^- to NO_2^- is the first step in the multi-stage denitrification process. Again, the initial step has to be faster than the subsequent steps to cause NO_2^- to accumulate. Since denitrification is an anaerobic process, O_2 is the factor most likely determining the equilibrium between NO_2^- formation and consumption besides NO_3^- availability (Burns et al., 1996). NO_2^- reductase is the denitrification enzyme most sensitive to O_2 , but in some bacteria it can also be inhibited at very high NO_3^- concentrations (Cole, 1994). Another factor for NO_2^- accumulation during denitrification can be C availability. If available C in soil is low, the competition for electrons is increased, with NO_3^- and NO being stronger electron acceptors than NO_2^- , leading to NO_2^- accumulation (Burns et al., 1996).

2.2.2 Agricultural practices

Agricultural practices are more responsible for NO_2^- accumulation than natural conditions. High NO_2^- concentrations may be found in soil after application of N fertilizers that tend to form alkaline solutions upon hydrolysis, such as urea and anhydrous NH_3 (Chalk et al., 1975; Chapman and Liebig, 1952). The initially high NH_4^+ concentrations in conjunction with an increased soil pH may have an inhibitory effect on NO_2^- oxidizers (Burns et al., 1996). Alkaline conditions promote dissociation of NH_4^+ to NH_3 ($\text{pK}_a = 9.3$), and so the accumulation of NO_2^- is often linked to the toxicity of free NH_3 for NOB (Venterea and Rolston, 2000b). The sensitivity of NOB to free NH_3 is about two orders of magnitude as much as than for AOB (Smith et al., 1997). Yet the increase in soil pH is only temporarily. With ongoing nitrification, pH decreases again because the oxidation of NH_4^+ to NO_2^- by AOB is associated with the release of protons, lowering the pH back to its original value or even below it (Chalk and Smith, 1983). In experiments with urea-treated soil, Burns et al. (1996) showed how NH_4^+ accumulated due to urea hydrolysis, accompanied by an increase in soil pH several days after application. This caused an accumulation of NO_2^- due to the inhibition of NO_2^- oxidation by free NH_3 . When soil pH and, as a consequence, free NH_3 concentrations decreased, nitrifiers became active again consuming NO_2^- (Burns et al., 1996).

The granule size and mode of application of alkaline hydrolyzing fertilizer also influence NO_2^- accumulation (Hauck and Stephenson, 1965). Soil chemistry in the proximity around a large water-soluble fertilizer granule will be affected more by the fertilizer than the same amount of N distrib-

uted more widely and uniformly in form of smaller granules, or fertilizer applied as solution. This indicates that rate and method of fertilizer application can reduce NO_2^- accumulation.

Urine patches are another relevant site for NO_2^- accumulation in soils. At these sites, spots of elevated pH and high NH_3 concentrations via urea hydrolysis can occur (Monaghan and Barraclough, 1992). By this, NO_2^- accumulation is a common phenomenon in grassland soils receiving high N inputs not only in the form of artificial fertilizer, but also as animal excrements (Burns et al., 1995).

An accumulation of more than $100 \text{ mg NO}_2^- \text{-N kg}^{-1}$ has been found after urea application (van Cleemput and Samater, 1996). Bezdicsek et al. (1971) found NO_2^- accumulation of up to $140\text{--}265 \text{ mg NO}_2^- \text{-N kg}^{-1}$ after the addition of granular NH_4^+ sulfate and urea prills to an alkaline soil. However, these are extreme values, and in most field studies NO_2^- concentrations were generally much lower (Burns et al., 1995; Davidson et al., 1991; Gelfand and Yakir, 2008; Venterea et al., 2003).

In a recent study, the contribution of urea and anhydrous NH_3 to elevated N_2O emissions was tested in a field-scale experiment over different growing seasons (Venterea et al., 2010). It was found that anhydrous NH_3 led to higher NO_2^- levels than urea and, therefore, to higher gaseous losses of N. NO_2^- accumulation following urea application can also occur, especially if applied as bands or as liquid urea- NH_4NO_3 (Mulvaney et al., 1997). Recently observed N_2O emissions from corn fertilized with anhydrous NH_3 were even twice as high as with urea (Venterea et al., 2010).

2.2.3 Drying/rewetting in seasonally dry ecosystems

In seasonally dry ecosystems the biological activity is limited by the temporally low amounts of water. This results in an inactivity of the N-cycling and other microbial-driven soil processes during drought. When water becomes available again, these ecosystems usually show high rates of biological activity and high N trace gas emission rates (Davidson et al., 1991). It was observed in an incubation experiment that NH_4^+ oxidation was activated immediately after rewetting of a dry soil, and NO_2^- accumulated at the same rate (Gelfand and Yakir, 2008). This NO_2^- accumulation was interpreted as a time delay between the transformations of NH_4^+ and NO_2^- as a consequence of different drought stress tolerance levels and recovery rates of AOB and NOB (Gelfand and Yakir, 2008). These findings are in accordance with the results of Tappe et al. (1999) who found that AOB were able to use substrate directly after starvation, while NOB needed a three-fold longer period before it was able to use NO_2^- . Another factor favoring NO_2^- accumulation under field conditions in dry environments are high salt concentrations in soil, which can inhibit NO_2^- oxidation to NO_3^- (Nejidat, 2005). These observations suggest a seasonal pattern of NO_2^- accumulation in ecosystems with highly periodic precipitation, with accumulation of NO_2^- being highest at the beginning of the rainy season, leading to pulses of N trace gas emissions at the onset of the first rains.

2.3. Abiotic N trace gas production mechanisms

As mentioned above, there are purely chemical reactions known to produce N trace gases. These reactions involve the nitrification intermediates (NO_2^- and NH_2OH) as N sources. These reactions can all occur simultaneously, and are all competing for N substrate between each other, and also with biological N transformation processes. The following sections give an overview over the main abiotic production mechanisms, their controls and kinetics.

2.3.1 Self-decomposition of NO_2^-

The chemical stability of NO_2^- in soil solution is associated with the equilibrium between HNO_2 and NO_2^- (van Cleemput and Samater, 1996). Therefore, it is highly dependent on pH. Due to the low pK_a (3.3 at 25 °C) for the equilibrium reaction (Pires et al., 1994), notable concentrations of HNO_2 do not occur in most soils. NO_2^- is stable above pH 5.5, so that HNO_2 should only form in acidic soils (van Cleemput and Baert, 1978). However, soil pH is not uniform and can vary largely at the microscale. The surface of a clay mineral is about 100 times more acidic than the surrounding soil solution (Harter and Ahlrichs, 1967), and the same applies to the vicinity of plant roots (Marschner et al., 1986), which could lead to shifts in the equilibrium.

The classic equation for HNO_2 decomposition is described as



Nelson and Bremner (1970a) found that the following equation represents HNO_2 self-decomposition in soil solution better:



HNO_2 decomposition produces NO_3^- only in closed systems with available O_2 , when there is no reagent in the system that sorbs NO and NO_2 (Nelson and Bremner, 1970a). In open systems, the produced NO may escape to the atmosphere, be absorbed by soil, or react under aerobic conditions with O_2 to form NO_2 (van Cleemput and Samater, 1996). Nelson and Bremner (1970a) found NO_2 as the main product of NO_2^- self-decomposition; van Cleemput and Baert (1984), however, measured only up to 1.4% of added NO_2^- being decomposed to NO_2 , with NO being the main gaseous product. This suggests that most of the produced NO_2 dissolves in soil as formulated by Smith and Chalk (1980):



Thus, NO_3^- is not the direct product of NO_2^- decomposition, but a product of the disproportionation of NO_2 , resulting from NO_2^- decomposition, as given in Equation (6) (Kappelmeyer et al., 2003). The amount of NO_3^- formed in this way is dependent on the rate of diffusion of NO_2 through the soil (Nelson, 1982).

In a recent study, Mørkved et al. (2007) found an immediate burst of NO production shortly after the addition of NO_2^- to sterile slurries of acidic soils (pH 4.1). This instantaneous NO peak was proportional to the amount of added NO_2^- . It was suggested that the rapid NO production was due to chemical decomposition of NO_2^- . The same sudden release of NO after the addition of NO_2^- to an acidic central African rain forest soil was found by Serça et al. (1994). The onset of the reaction only seconds after the addition of NO_2^- indicates a purely chemical reaction, which could be corroborated by the modification of the pH (Serça et al., 1994). Yamulki et al. (1997) made the observation in a comparison of sterile and non-sterile grassland soil cores that an important fraction (29% at pH 3.9) of NO was produced via chemical decomposition of NO_2^- . These results are in agreement with a previous study by Nägele and Conrad (1990), who observed a 71% conversion rate of consumed NO_2^- to NO in autoclaved soil slurries at pH 4.

It is accepted that the self-decomposition of NO_2^- follows first-order or pseudo-first-order kinetics (van Cleemput and Baert, 1984), as a significant linear relationship between NO_2^- concentration and incubation time in different treatments was found (Laudelout et al., 1977). The first-order rate constant was discovered to be influenced by NO_2^- concentration, temperature, and pH (Laudelout et al., 1977). NO_2^- decomposition is stimulated by decreasing pH and by addition of NO_2^- . Subsequently, the dilution of the soil solution leads to a decrease of the reaction. Venterea and Rolston (2000a) noticed that the emission of NO correlated rather with HNO_2 than with NO_2^- alone, which also emphasizes the stimulating effect of NO_2^- concentration and pH on NO_2^- decomposition because both account for the formation of HNO_2 as mentioned above. As a purely chemical process, the decomposition of NO_2^- has no temperature optimum and will increase with increasing temperature (Kesik et al., 2006). Venterea et al. (2005) found a negative correlation between abiotic NO emissions and soil water content, and emphasized the occurrence of abiotic NO production primarily at the interface of soil surface and soil solution. They explained the relation between NO emissions and soil water content by an increasing ratio of interfacial area between soil matrix and solution, and additionally the importance of surficial acidity of soil mineral and organic particles that in turn is also related to cation exchange capacity of a soil. The hypothesis of a surface-mediated reaction also implies the effect of soil clay and SOM content and surface charge density on abiotic NO formation (Venterea et al., 2005).

A recently found source of gaseous N loss from acidic soils that can be closely linked to nitrite self-decomposition is the release of nitrous acid in gaseous form (HONO) (Su et al., 2011). Besides the equilibrium between NO_2^- and HNO_2 in the aqueous phase, aqueous HNO_2 is also in equilibri-

um with gaseous HONO, which is also controlled by acidity and the NO_2^- concentration. When the HONO equilibrium gas phase concentration is higher than the actual HONO gas phase concentration, HONO is released from the aqueous phase (Su et al., 2011). Su et al. (2011) as well as Oswald et al. (2013) showed that soil NO_2^- can act as a strong source of HONO. This makes NO_2^- in acidic soils not only a potential source of elevated abiotic NO emissions, but also of high abiotic HONO emissions.

2.3.2 Reactions of NO_2^- with metals

The reaction of NO_2^- with metals in their reduced state, leading to the formation of gaseous N products, has long been recognized as another non-enzymatic pathway of N loss from soils. Wullstein and Gilmour (1964) introduced a mechanism, wherein NO_2^- is reduced to NO by certain transition metals in sterile, moderately acidic soils by the following reaction (with Fe^{2+} representing redox-active transition metals):



Transition metals promoting NO_2^- losses in their reduced state were found to be iron, copper, and manganese (Wullstein and Gilmour, 1964). Nelson and Bremner (1970b) found that only cuprous (Cu^+), ferrous (Fe^{2+}), and stannous (Sn^{2+}) ions promote NO_2^- decomposition, and showed on the basis of the standard electrode potentials that manganous (Mn^{2+}) ions cannot reduce NO_2^- in acidic media. However, the authors stated that there is no evidence that the concentrations of Fe^{2+} , Cu^+ , and Sn^{2+} in soils under conditions promoting chemodenitrification are high enough to play a significant role in NO_2^- decomposition. Studies in buffered solutions indicate that Fe^{2+} and Cu^+ concentration must at least be 56 and 318 mg l^{-1} , respectively, before the mechanism according to Equation (7) can proceed (Jones et al., 2000).

A reaction between NO_3^- and dissolved Fe^{2+} has also been shown in the literature (Postma, 1990):

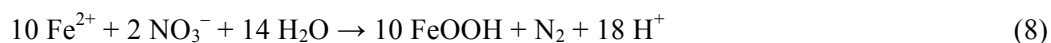

However, this reaction appears to be very slow at lower temperatures, and is, therefore, not of high relevance in natural systems (Postma, 1990). Ottley et al. (1997) suggested that such an abiotic reduction of NO_3^- may only be feasible in groundwater with solid phase copper as a catalyst on a timescale of months to years.

Controlling factors

Controlling factors of Fe^{2+} -mediated NO_2^- decomposition are commonly reported to be pH and the concentrations of NO_2^- , NO_3^- , and Fe^{2+} (with NO_3^- having a much lower reactivity than NO_2^-) (Moraghan and Buresh, 1977; Nelson and Bremner, 1970b; Sørensen and Thorling, 1991; van Cleemput and Baert, 1983). Equation (7) requires that hydrogen ions are present in soil solution, so that at least moderate acidity is a prerequisite for this reaction. However, a considerable variability on the influence of pH on NO_2^- decomposition by Fe^{2+} is reported in the literature. While Chao and Kroontje (1966) found a decreasing reduction of NO_2^- by Fe^{2+} as pH increases from 5 to 6, which is in conjunction with the results of van Cleemput and Baert (1983), Moraghan and Buresh (1977), in contrast, observed a higher N trace gas production when raising the pH in a Fe^{2+} -containing medium from 6 to 8. At pH 6, however, a catalytic effect of Cu^{2+} ions on NO_2^- decomposition by Fe^{2+} was found that appears to have little environmental significance yet (Sørensen and Thorling, 1991). Jones et al. (2000) argued that the reduction of NO_2^- by reduced metal ions is the only abiotic NO_2^- decomposition reaction in soils that does not require HNO_2 and is therefore possible at higher pH. The influence of pH is very complex, as it changes the equilibrium between NO_2^- and free HNO_2 and the speciation of iron through the formation of different Fe^{3+} -precipitates and oxihydroxide species (Kampschreur et al., 2011). From their experiments, van Cleemput and Baert (1983) concluded that all conditions leading to high amounts of Fe^{2+} in solution, i.e., a low redox potential and low pH, but also the physical structure of the iron compound, enhance NO_2^- decomposition. Less crystalline iron oxides, and even more so amorphous iron, are more soluble than crystalline iron and stimulate NO_2^- decomposition by bringing more Fe^{2+} into solution (van Cleemput and Baert, 1984).

Kinetics and mechanisms

The kinetics of the Fe^{2+} -enhanced NO_2^- decomposition were found to be second order (van Cleemput and Baert, 1983). The rate constant increased with increasing Fe^{2+} -concentration, but decreased with increasing pH. The dependence of the reaction on temperature increased at lower pH levels or at increasing Fe^{2+} -concentrations (van Cleemput and Baert, 1983). The half-life of NO_2^- is obviously reduced by lower pH values and higher Fe^{2+} concentrations, yet, the influence of Fe^{2+} decreases at very high concentrations. Kampschreur et al. (2011) found the kinetics to be more affected by NO_2^- than by iron.

While conditions for NO_2^- and Fe^{2+} accumulation do not occur coincidentally in one soil layer, the possibility for the reaction exists at the interface between an aerobic zone overlaying an anaerobic zone where NO_2^- moving downwards meets Fe^{2+} moving upwards (Sørensen and Thorling, 1991; van Cleemput and Baert, 1983). Still, concentrations of Fe^{2+} ions in most soils are considered too

low to promote NO_2^- decomposition (Nelson and Bremner, 1970b; van Cleemput and Samater, 1996). The impact of metal cations on NO_2^- decomposition is controversial, while some authors rule out the possibility that soil minerals and metal cations play a significant role completely (Bremner, 1997), others argue that iron, especially in highly soluble compounds, has a stimulating effect, and therefore intensifies NO_2^- decomposition even in slightly acidic soils (van Cleemput, 1998).

Recently, Kampschreur et al. (2011) argued that the iron turnover rate is highly dependent on NO_2^- concentration, and that it is fast enough to be responsible for significant N trace gas emissions, especially when NO_2^- accumulates. This mechanism suggests a coupling between the iron and N cycles. While Fe^{3+} is reduced to Fe^{2+} biologically, Fe^{2+} subsequently reduces NO_2^- to NO by the simultaneous oxidation of Fe^{2+} in a purely chemical reaction (Brons et al., 1991). Some of the NO can then be loosely bound to excess Fe^{2+} , so the Fe^{2+} -NO complex may not work as a permanent sink for NO (Brons et al., 1991). Moreover, NO can react further with Fe^{2+} in a similar reaction as NO_2^- to form N_2O :

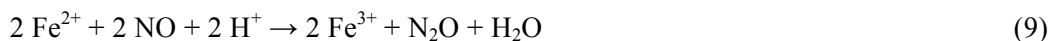

As the purely chemical reactions proceed very fast, the system will be limited by the availability of Fe^{2+} (Sørensen and Thorling, 1991). Kampschreur et al. (2011) endorsed the idea of a two-step mechanism for the reduction of NO_2^- by Fe^{2+} according to Equations 7 and 9, leading to N_2O emission, with NO as an intermediate. In their study, the emission of NO occurred immediately after the addition of NO_2^- to Fe^{2+} , while N_2O emission was only observed after a significant amount of Fe^{2+} had been oxidized by NO_2^- , leading to the formation of Fe^{3+} precipitates. The reduction rate of NO was found to be strongly dependent on the size of the reactive surface and the Fe^{2+} sorption to it (Kampschreur et al., 2011). Thus, compared to NO formation kinetics, which appear to be first order, the formation of N_2O via metal cations seems to be more complex due to the Fe^{3+} mineral formation kinetics (Kampschreur et al., 2011).

Another reaction mechanism for the reduction of NO_2^- by Fe^{2+} directly to N_2O was proposed by Sørensen and Thorling (1991), who used a lepidocrocite suspension for their laboratory study:

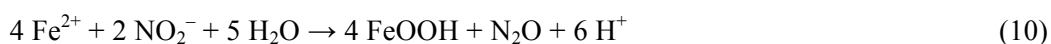

A different formulation of this reaction, that takes into account that magnetite formation is favored under the experimental conditions used by Sørensen and Thorling (1991), is:

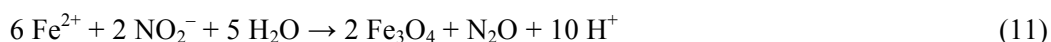

In their findings the presence of lepidocrocite was required for the initiation of the reaction between Fe^{2+} and NO_2^- , while the reaction was very slow in the absence of lepidocrocite. It is assumed that rather a complexed, more reactive form of Fe^{2+} is involved than dissolved Fe^{2+} . Therefore, two simultaneous processes are important: the initial binding of Fe^{2+} to build a simple Fe^{2+} -containing complex with a Fe^{3+} oxyhydroxide, and the subsequent reaction between NO_2^- and the Fe^{2+} -containing compound (Sørensen and Thorling, 1991).

An increased N_2O production due to the reduction of NO_2^- and the simultaneous oxidation of Fe^{2+} to Fe^{3+} was also observed in the presence of goethite (Cooper et al., 2003). These results are in accordance with Coby and Picardal (2005), who also found this reaction to be surface-catalyzed and failed to detect any significant N_2O production in systems lacking a surface catalyst. It is likely that surface reactions are not restricted to pure iron oxide, but can also be catalyzed by iron-containing sediments and soil particles. Coby and Picardal (2005) discussed the possibility of such reactions on microbial cell surfaces which have adsorbed Fe^{2+} . A recent study confirmed the assumption of a surface-catalyzed reaction (Tai and Dempsey, 2009). The authors used hydrous ferric oxide as their Fe^{3+} source and did not observe any reduction of NO_2^- in the absence of hydrous ferric oxide. Another interesting finding is that solid-bound Fe^{2+} does not react with NO_2^- in the absence of dissolved Fe^{2+} , so that the reaction stopped once dissolved Fe^{2+} was depleted (Tai and Dempsey, 2009).

Another, yet similar mechanism was proposed by Samarkin et al. (2010) only recently, who found N_2O fluxes similar to those from fertilized tropical soils from a hypersaline playa lake without any biological activity in Antarctica. They observed N_2O emissions higher than expected on the lakeshore and tested the hypothesized chemical reaction in the laboratory. The suggested mechanism is a reaction between NO_2^- -rich brine and Fe^{2+} -containing minerals derived from the surrounding igneous Ferrar Dolerite. The proposed reaction equation is the same as in Equation (11). Samarkin et al. (2010) found that the production of N_2O is 100 times higher with NO_2^- than with NO_3^- , thus the reduction of NO_3^- to NO_2^- will be the rate-limiting step. The reaction was observed at -20°C with an increasing N_2O production rate with increasing temperature. The Arrhenius activation energy (E_A) of this reaction was 18.4 kJ mol^{-1} , indicating a diffusion-controlled reaction (Samarkin et al., 2010).

2.3.3. Reactions of NO_2^- with SOM

NO_2^- decomposition

Several studies published in the past noted a connection between the rate of NO_2^- decomposition and SOM content (e.g., Blackmer and Cerrato, 1986; Bremner and Führ, 1966; Kappelmeyer et al., 2003; Nelson and Bremner, 1970a; Thorn and Mikita, 2000). Most of these studies showed an en-

hanced decomposition of NO_2^- in the presence of SOM in soils. Nelson and Bremner (1969) found in a study with several soils that the removal of SOM by combustion markedly reduced the soils' ability for NO_2^- decomposition. In the same study, they noticed that the soils with the highest C content were characterized by the largest recovery of added N due to fixation to SOM, and that SOM promoted decomposition of NO_2^- at a pH above 5, where self-decomposition of NO_2^- is very limited.

NO_2^- fixation

The ability of soils to fix NO_2^- by a purely chemical reaction with SOM was first demonstrated by Bremner and Führ (1966). They found that this fixation did not only occur in C-rich acidic, but also in mildly alkaline soils, and pointed out that the mechanism behind the fixation reaction likely involves aromatic structures of organic material. Lignin and the lignin-like fraction of SOM have been found to have the largest capacity for NO_2^- fixation of all tested organic substances (Bremner and Führ, 1966). It is known that phenolic materials react with HNO_2 to form nitroso compounds, which is likely the mechanism behind the reaction between NO_2^- and lignin, a phenolic substance of high molecular weight.

Führ and Bremner (1964a) found a fixation of 11% and 16% of added NO_2^- in two mineral soils with a gaseous N loss of 79% and 77%, respectively. In an acidic peat soil, a NO_2^- fixation of even 28% of the added NO_2^- and a reduced gaseous N loss of 63% were reported in the same study. In another experiment, Führ and Bremner (1964b) found that even at neutral to slightly alkaline conditions up to 25% of added NO_2^- -N were fixed by SOM, although the reaction is pH-dependent and fixation is promoted by acidity.

Besides pH, soil C content is another important controlling factor, as a high correlation between SOM and the amount of N fixed was observed (Führ and Bremner, 1964b). The fixation mechanism was shown even at low NO_2^- concentrations, at which relatively more NO_2^- was fixed (Führ and Bremner, 1964b). The authors found the chemical fixation of NO_2^- to be faster than the self-decomposition of NO_2^- , as it occurred at very low pH where NO_2^- self-decomposition is very rapid. Stevenson et al. (1970) assumed phenolic groups being also involved in the formation of NO, so that the reaction of NO_2^- with SOM not only enhances NO_2^- fixation, but may also lead to the abiotic production of NO. Bremner and Führ (1966) concluded that, although SOM is involved in the gaseous loss of NO_2^- , high SOM contents tend to reduce the gaseous loss of N due to chemical fixation and by the promotion of microbial nitrification.

Nitrosation reaction mechanism

Stevenson et al. (1970) presented the idea of nitrosation reactions, i.e., the formation of a nitroso group due to the reaction of NO_2^- with an organic molecule, as the mechanism behind NO_2^- fixation by SOM, but stated that the formed nitroso compounds are labile and may undergo further reactions to form gaseous N compounds. They obtained NO as the main gaseous product beside N_2 , N_2O , and CO_2 as minor components in the reaction of NO_2^- with lignin and humic preparations even at neutral pH, where self-decomposition of NO_2^- is negligible.

Blackmer and Cerrato (1986) suggested that the highest abiotic production of NO can be associated with soils having high SOM content and low pH. The formation of nitrosophenols and oximes from phenolic entities and activated methylene groups upon nitrosation of fulvic and humic acids was demonstrated by Thorn and Mikita (2000). Like Stevenson et al. (1970) before, Thorn and Mikita (2000) also observed formation of N_2O upon reaction between NO_2^- and SOM at neutral to mildly alkaline pH values. They discussed the reaction of a second HNO_2 molecule with an oxime group, formed during the reaction of HNO_2 with a phenol or an activated methylene group, as a possible mechanism, in which the formation of an N–N-bond constitutes the first step. The authors observed CO_2 as another gaseous product upon nitrosative decarboxylation of certain aromatic acids.

Boudot and Chone (1985) presented a scheme of the internal N cycle in humiferous acidic soils implying importance to the effect of SOM on abiotic fixation and decomposition of NO_2^- . In an acid colluvial soil with a high humic acid content they found a NO_2^- fixation of 68%, with only 20% being available for further nitrification. In these acidic soils with high organic C contents, Boudot and Chone (1985) found nitrification of NO_2^- to NO_3^- even completely suppressed by enhanced self-decomposition of HNO_2 and fixation of NO_2^- to SOM.

In a field study on the effects of long-term N inputs in two temperate forest soils, Magill et al. (2000) found a near complete retention of added ammonium nitrate and discussed three possible mechanisms for the incorporation of N into SOM: N immobilization by microbes, mycorrhizal assimilation and exudation of organically bound N, and chemical reactions with SOM. Their results suggest a greater importance for abiotic N transformation pathways than previously thought, with nitrosation reactions playing a prominent role.

In a recent laboratory study (Islam et al., 2008), a fast ^{15}N incorporation of about 20% into the SOM pool was observed after the addition of ^{15}N -labelled NO_2^- to two soils with a pH of about 5 and an organic C content above 6%, while in an alkaline soil (pH 8.1) no ^{15}N was recovered from SOM at all, pinpointing the importance of soil pH. The fast nature of these chemical reactions could also explain low nitrification in some soils. In contrast, Kappelmeyer et al. (2003) found indeed enhanced abiotic N trace gas formation by artificial humic matter, but failed to find N incorporation. Venterea and Rolston (2000a) observed a strong positive correlation between the pro-

duction rates of NO ($r^2 = 0.9$) and N₂O ($r^2 = 0.82$) in sterile agricultural soils with organic C contents from 0.3–1.4%. This data is consistent with further experiments in which a non-linear relation between abiotic NO production and NO₂⁻ concentration was observed that may be related to reactions of NO₂⁻ with SOM (Venterea and Rolston, 2000b).

Abiotic NO₃⁻ fixation

A study by Dail et al. (2001) with live and sterilized soils suggested that NO₃⁻ added to an acidic forest soil undergoes a fast abiotic immobilization via incorporation into insoluble SOM. This was in obvious contrast to the results of Colman et al. (2007), who could not find any evidence of abiotic NO₃⁻ incorporation in samples from 45 North and South American soils. They argued that reported abiotic incorporation of NO₃⁻ was due to analytical artifact. As an explanation, the possibility of a partial reduction of NO₃⁻ to NO₂⁻ by biological respiration and/or abiotic processes followed by an incorporation of NO₂⁻ into SOM was discussed (Dail et al., 2001; Fitzhugh et al., 2003).

Based on these findings, Davidson et al. (2003) proposed the “ferrous wheel hypothesis” for the abiotic NO₃⁻ immobilization in soils. In this conceptual model, Fe³⁺ is reduced by SOM to Fe²⁺, the produced reactive Fe²⁺ species in turn reduce NO₃⁻ to NO₂⁻, and NO₂⁻ subsequently reacts with phenolic organic matter to form dissolved organic N compounds (Davidson et al., 2003). However, there is some controversy about this hypothesis. Colman et al. (2008) questioned the second step of the “ferrous wheel hypothesis”, i.e., the reaction between Fe²⁺ and NO₃⁻. This reaction is very slow in absence of a catalyst, and the suggested catalysts (copper, green rust or surface bound Fe²⁺) would rather produce NH₃ or N₂ (see Equation (8)) than NO₂⁻ (Hansen et al., 1994; Ottley et al., 1997; Postma, 1990).

As illustrated above, SOM plays a complex role in NO₂⁻-driven abiotic processes in soils, on the one hand being able to fix N in soil and on the other hand enhancing gaseous N emissions. There is still controversy about its relevance for N trace gas emissions, and not all mechanisms are adequately understood. Beyond NO₂⁻, several other potential pathways for abiotic nitrosation reactions with low molecular weight N compounds, such as NH₃, NH₂OH, and amino acids, add to the complexity (Thorn and Mikita, 2000). The role of SOM suggests that agricultural management practices, which are aligned to increase soil C storage, may have the unintentional side-effect of enhanced N₂O emission that could counteract greenhouse gas benefits of C sequestration (Venterea, 2007).

2.3.4. Reactions involving hydroxylamine

NH₂OH is the first intermediate in the enzymatic transformation of NH₃ to NO₂⁻ by autotrophic nitrifying bacteria and archaea. Although there has long been no evidence for the extracellular re-

lease of NH_2OH and no reports of detection in soil, there is a possibility of fast chemical decomposition of NH_2OH leading to the formation of N_2O and N_2 (Bremner et al., 1980). Nelson (1978) found that NH_2OH is quantitatively decomposed by HNO_2 at a soil pH below 5:



This is long known in chemistry and was first described by Meyer (1875). In aqueous solution, NH_2OH and HNO_2 react readily at room temperature (Hughes and Stedman, 1963). The reaction is pH-dependent and increases rapidly below pH 4, as HNO_2 rather than NO_2^- is the reactive species (Stevens and Laughlin, 1994). Döring and Gehlen (1961) found that the mechanism of HNO_2 on NH_2OH involves a primary nitrosation of free NH_2OH . N_2O_3 likely acts as the nitrosating agent (Hughes and Stedman, 1963). The nitrosation reaction shows a high kinetic complexity with different intermediates. Döring and Gehlen (1961) argued that especially in buffered solution the nucleophilic buffer anion can work as a carrier for nitrosating species and exert great influence on the reaction kinetics. Bothner-By and Friedman (1952) found that at neutral pH a symmetrical intermediate is involved, presumably hyponitrous acid (HO-N=N-OH) or rather its anion hyponitrite ($^-\text{O-N=N-O}^-$), while at lower pH values, the initial nitrosation leads to the formation of an unsymmetrical intermediate, presumably N-nitrosohydroxylamine. The exact mechanism is still not completely understood, mainly because of the fast sequential isomerization stages and proton transfer from NH_2OH to the end product N_2O (Fehling and Friedrichs, 2011). Nitroxyl (HNO), the monomer of hyponitrous acid, has long been recognized as an important direct precursor of chemical N_2O formation (Bonner and Hughes, 1988). A recent modeling study proved that N_2O production was initialized by the formation of HNO , followed by a fast dimerization leading to hyponitrous acid (Fehling and Friedrichs, 2011).

In soils, the simplified reaction mechanism of N_2O formation from NH_2OH is composed of two steps: first the enzymatic production of NH_2OH , and second the chemical decomposition of NH_2OH (Stüven et al., 1992). N_2O has been reported to be the major product of this reaction, and only small amounts of N_2 were produced, except for calcareous soils, in which N_2 formation exceeded that of N_2O (Bremner et al., 1980). Bremner et al. (1980) observed that the production of N_2O by NH_2OH decomposition significantly exceeded the production of N_2O via NO_2^- self-decomposition from different sterilized soils in a laboratory incubation experiment, in which NO was the major product.

From laboratory experiments, Minami and Fukushi (1986) presumed that the interaction between NO_2^- and NH_2OH is largely of chemical origin. However, Bremner et al. (1980) and Minami and Fukushi (1986) found that the addition of NO_2^- to sterilized soils treated with NH_2OH did not prominently increase the production of N_2O . Furthermore, the formation of N_2O was found to be

faster than the reaction between NO_2^- and NH_2OH in the absence of soil (Bremner, 1997). This suggests that another reaction must also be responsible for the decomposition of NH_2OH in soil. Bremner et al. (1980) detected a correlation between the formation of N_2O through the chemical decomposition of NH_2OH and oxidized forms of iron and Mn. A scheme for the reaction of NH_2OH and an iron-containing compound was presented by Butler and Gordon (1986):

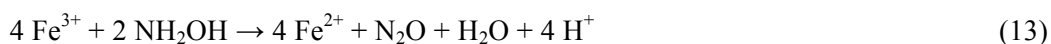

However, although Fe^{3+} is generally much more abundant in soils than Mn^{4+} , NH_2OH will preferably react with manganese because of the higher redox potential of the $\text{Mn}^{4+}/\text{Mn}^{2+}$ redox pair compared to the $\text{Fe}^{3+}/\text{Fe}^{2+}$ redox pair. This fact also allows the selective extraction of manganese with NH_2OH in soil chemical analyses, while leaving the major part of the iron unaffected (Chao, 1972). It has also been shown that small amounts of buffer substances can significantly reduce the rate of the reaction represented by Equation (13) (Heil et al., 2014). In soils iron might be complexed too tightly to be available as a reaction partner for NH_2OH . Thus, it appears that a reaction with manganese, as postulated by Nelson (1978), could be more important despite the generally lower manganese content in soils compared to iron:

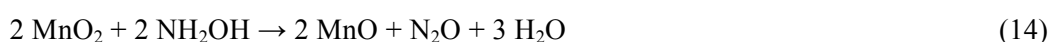

These two equations (13) and (14) are a simplistic representation of the chemical mechanisms, as there are more intermediate steps involved, and again HNO was proposed as the key intermediate (Butler and Gordon, 1986). Spott and Stange (2011) recently proved in a laboratory experiment in a slightly alkaline soil suspension that NH_2OH was rapidly transformed into N_2O within a few hours after NH_2OH application, independently from the presence of NO_2^- or NO_3^- . These results are in accordance with Bremner et al. (1980) who reported a major conversion of NH_2OH to N_2O within two hours by a redox reaction with oxidized metal species.

Besides oxidation by soil constituents, NH_2OH can also be oxidized by O_2 , or undergo disproportionation (Bonner et al., 1978; Moews and Audrieth, 1959). However, both processes are considerably slower than the processes mentioned above. The oxidation of NH_2OH by O_2 is faster than the disproportionation, which was not observed at pH 3, and was only slightly higher at elevated pH (Bonner et al., 1978). However, both processes are significantly catalyzed by transition metals, especially copper, so that they cannot be completely excluded, and should be mentioned in this context.

In an experiment it was found that after NH_2OH addition to soil not all of the $\text{NH}_2\text{OH-N}$ could be accounted for as gaseous N loss or as inorganic forms of N (Nelson, 1978). The amount of non-

recovered $\text{NH}_2\text{OH-N}$ exhibited a strong positive correlation with SOM content (Bremner et al., 1980; Nelson, 1978). On average, 25% of added $\text{NH}_2\text{OH-N}$ was apparently organically bound and not easily extractable after fixation. It is known that NH_2OH reacts with several SOM sources, especially carbonyl groups, to produce oximes (Porter, 1969), so the observed NH_2OH fixation likely occurs via the formation of oximes in a reaction of NH_2OH with carbonyl groups in SOM and humic acids (Nelson, 1978):

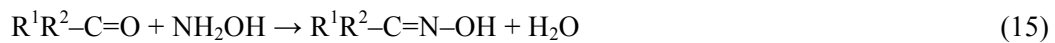

This reaction was also made use of to measure carbonyl groups in SOM (Porter, 1969).

A mechanism by which NH_2OH is released from microorganisms into the medium was proposed by Stüven et al. (1992): when electrons are generated by the oxidation of pyruvate or formate, an imbalance between NH_3 and NH_2OH oxidation is induced, and NH_2OH is released. It was shown that during nitrification by mutant strains of *Nitrosomonas europaea* high amounts of NH_2OH were released into the medium and N_2O was subsequently emitted most likely via chemical decomposition of NH_2OH (Schmidt et al., 2004b). Although a release of NH_2OH may not be favorable for AOB, as NH_2OH oxidation to NO_2^- is an energy-generating step for them (Arp and Stein, 2003), abiotic reactions of NH_2OH may still take place, owing to the high reactivity of NH_2OH . The usual lack of detection of NH_2OH in soils may be due to the high reactivity of NH_2OH in four competing processes: (i) the chemical formation of N_2O , (ii) the abiotic incorporation of NH_2OH in SOM, (iii) the oxidation of NH_2OH to NO_2^- during nitrification, and (iv) biotic N_2O formation (Spott and Stange, 2011).

It cannot be ignored that N_2O is generated from the decomposition of NH_2OH , still most authors are in agreement that it is not a main mechanism for the production of N_2O in soils under field conditions (Bremner, 1997; Bremner et al., 1980; Conrad, 1996; Minami and Fukushi, 1986). Nevertheless, if the non-detection of NH_2OH in soils is only due to the fast chemical decomposition, emissions from chemical reactions of NH_2OH can probably be much higher than widely expected. Spott and Stange (2011) presumed that due to the rapid chemical NH_2OH conversion, N_2O produced during nitrification may be abiotically produced from NH_2OH rather than derived microbially. Depending on soil conditions, such as pH, redox state, and content of redox active metals (e.g., manganese, iron), the consideration of this coupled biotic–abiotic N_2O formation in mechanistic models for simulation of soil N_2O emissions might become relevant.

2.4. Implications of abiotic processes in terrestrial N trace gas emissions

Although some purely abiotic processes, as described above, have been shown to contribute to the formation of N trace gases from soils under certain soil conditions, most studies merely focus on enzymatic pathways as the sole source of N trace gases. While some authors endorse the idea of the abiotic production of N trace gases, they still do not account for it in their studies (e.g., Baggs et al., 2010; Stevens et al., 1997; Zhang et al., 2011; Zhu et al., 2011). This may lead to a potential overestimation of biological processes and thus an underestimation of the significance of abiotic pathways.

Relatively few studies have tried to quantify the contribution of chemical processes to total N trace gas emissions from soils, especially at field-scale. Yamulki et al. (1997) observed NO fluxes from a sterilized soil core (pH 3.9) of 29% compared to the equivalent soil core before sterilization, that were sharply reduced with increasing pH. N₂O production was found to be negligible. These results coincide with more recent studies, which contributed higher NO emissions from acidic agricultural soils partially to chemical decomposition of NO₂⁻ (Cheng et al., 2004). In a laboratory study, Kesik et al. (2006) noticed that up to 62% of the production of NO was due to chemical decomposition of NO₂⁻ in acidic soils (pH <4), while contribution to N₂O production was only minor (0.8%). They observed no abiotic N trace gas production at a pH above 4.5. Ding et al. (2010) observed NO emissions from a sterilized agricultural soil at pH 8, possibly by a reaction of NO₂⁻ with SOM. At this high pH, NO emissions were reduced to 7–13% of the emissions prior to sterilization. Nevertheless, Venterea (2007) estimated that abiotic processes account for 31–75% of the total N₂O production of fertilized agricultural soils.

The effects of abiotic N trace gas production have been implemented into a process-oriented model for N₂O and NO emissions from temperate forest soils by Li et al. (2000). However, in this model, chemical processes are only responsible for the production of NO, as this model only considers “classical” chemodenitrification, i.e., chemical processes involving NO₂⁻/HNO₂. In their model, Li et al. (2000) calculated abiotic NO production as a function of nitrification rate, soil temperature (after Yamulki et al., 1997), and soil pH (after Blackmer and Cerrato, 1986). The implementation of the nitrification rate into the calculation emphasizes the interaction between biotic and abiotic processes.

The model validation by Stange et al. (2000), run on data from different field sites, showed that at a beech site with a soil pH of 4 approximately 9% of total NO was produced abiotically, while at a spruce site in the same forest with a lower pH of 3.2, abiotic NO production increased markedly to 30% of the total NO emission. However, the assumption of the model was a uniform bulk soil pH, but microsite variability in acid forest soils has been shown to be up to a scale of 3 pH units (Bruehlheide and Udelhoven, 2005; Kesik et al., 2005). The model was used by Kesik et al. (2005)

for an inventory of European forest soils. Highest NO emissions ($7.0 \text{ kg N ha}^{-1} \text{ yr}^{-1}$) were simulated for the Netherlands and the neighboring areas in Belgium and Germany, due mainly to the low soil pH in that region, high atmospheric N deposition rates, and a higher abiotic production of NO (Kesik et al., 2005).

Further approaches had been made using stable isotope labeling techniques, where the N substrates are labeled with ^{15}N . Stevens et al. (1997) made experiments to differentiate between microbial nitrification and denitrification by labeling different substrate sub-pools and quantifying the ^{15}N enrichments in N_2O emissions. However, the distinction between biotic and abiotic processes relying on the same substrate is difficult. Recent approaches of incorporating the information gained from these isotope tracing techniques into a ^{15}N tracing model could help to further quantify N_2O emissions from different pathways (Müller et al., 2014). Although the authors did not include abiotic pathways in their model, they found that the majority of N_2O emissions from old grassland soil were not associated with autotrophic nitrification or denitrification.

In the recent past, N_2O emissions by nitrifying bacteria have been attributed to the so-called nitrifier denitrification (Wrage et al., 2001). Nitrifier denitrification is a facultative pathway of nitrifiers in which NO_2^- is reduced anaerobically to N_2 via NO and N_2O by the same autotrophic microorganism (Wrage et al., 2001). The pathway from NH_4^+ via NO_2^- to N_2O was introduced by Poth and Focht (1985), and further to N_2 by Poth (1986). NH_3 oxidizers may use NO_2^- as an alternative electron acceptor for O_2 when being subjected to oxygen deficiency (Ritchie and Nicholas, 1972). Poth and Focht (1985) hypothesized that nitrite reductase and nitric oxide reductase, the same enzyme as utilized by microorganisms involved in denitrification, are responsible for the transformation. The presence of the two enzymes has been confirmed in the genome sequence of *Nitrosomonas europaea* by Chain et al. (2003). However, the enzyme responsible for N_2O reduction has not been identified in nitrifiers yet (Chapuis-Lardy et al., 2007). The genome revealed the interesting feature that this bacterium requires NH_3 as a substrate, and no capability was found to use other inorganic sources of energy. There is still a lot of uncertainty about the contribution to N_2O emitted from soils that reach from insignificant to about 30% of total produced N_2O (Wrage et al., 2001). In a recent study it was shown, that nitrifier denitrification can be a major contributor to total N_2O production from soil and can outbalance conventional denitrification at WFPS of 50–70% (Kool et al., 2011).

However, most studies only show that biological NH_3 oxidation is a crucial process for soil N_2O production under certain conditions, and all known microbial N_2O production pathways require anaerobic conditions, whereas the presented chemical reactions involving NH_2OH can lead to N_2O production also under aerobic conditions. Hooper and Terry (1979) already stated that the incomplete oxidation of the nitrification intermediate NH_2OH can lead to the development of N_2O . This matches the “nitrification-unstable intermediate” hypothesis formulated but abandoned by Poth and

Focht (1985), in which N_2O is produced during nitrification by various reactions of intermediates formed during NH_3 oxidation. This does not mean that all N trace gas production other than through classical, nitrifier-, or co-denitrification has to be completely chemical per se, but it is likely that there is an interlink between the biological nitrification pathway and purely chemical reactions: nitrification providing the intermediates, NH_2OH and NO_2^- , as reactants for chemical N_2O formation reactions. Thus, biological NH_3 oxidation to NO_2^- can be a source of N_2O , indirectly via chemical reactions of reactive and unstable intermediates, as depicted in a conceptual model in Figure 2.1.

The proposed coupled mechanism of biological NH_3 oxidation and chemical oxidation of NH_2OH could also easily explain the non-detection of N_2O emission from sterile soil samples, even with added NO_2^- , by some authors (e.g., Ding et al., 2010; Mørkved et al., 2007; Mummey et al., 1994; Yamulki et al., 1997). While NO_2^- decomposition mainly produces NO , NH_2OH seems to be the key component for the abiotic N_2O production in soils. All chemical processes that have been found relevant to produce N_2O in soils require NH_2OH as precursor (Udert et al., 2005). This can be explained in the sense that the reactions proceed as an N comproportionation (Spott et al., 2011). N_2O is formed by the reaction between a nucleophilic N with the formal oxidation state -1 (NH_2OH) with an electrophilic N species when the formal oxidation state is $+3$, like in NO_2^- or an nitrosonium cation (NO^+) in a nitrosation reaction (Spott et al., 2011). Due to the highly reactive character, NH_2OH will usually not accumulate in soils. However, Liu et al. (2014) developed a highly sensitive method for the detection of NH_2OH in soils and found a significant linear relationship between NH_2OH and N_2O formation under aerobic conditions in an acidic spruce forest soil. As NH_2OH might also be immobilized by SOM, making it unavailable for reactions leading to N_2O , it requires active nitrification, providing new NH_2OH , to trigger abiotic N_2O production. Therefore, it can possibly not be observed in sterile soils and will lead to an underestimation of abiotic N_2O production in soil and a misinterpretation of the underlying mechanisms.

Another important step for a better understanding and future modeling of N in soils will be the coupling of different biogeochemical cycles. A good example is the ferrous wheel hypothesis (Davidson et al., 2003). Although being challenged by some authors (Colman et al., 2008; Schmidt and Matzner, 2009), the approach of Davidson et al. (2003) to combine different cycles is definitely pointing to the right direction. Biogeochemical cycles cannot be looked at in an isolated manner when trying to understand soil processes. The gearing of different element cycles into each other will make modeling of N transformation in soil more complex than it already is, but is needed for a better understanding of the different processes involved and will improve predictions of N trace gas emissions from soils.

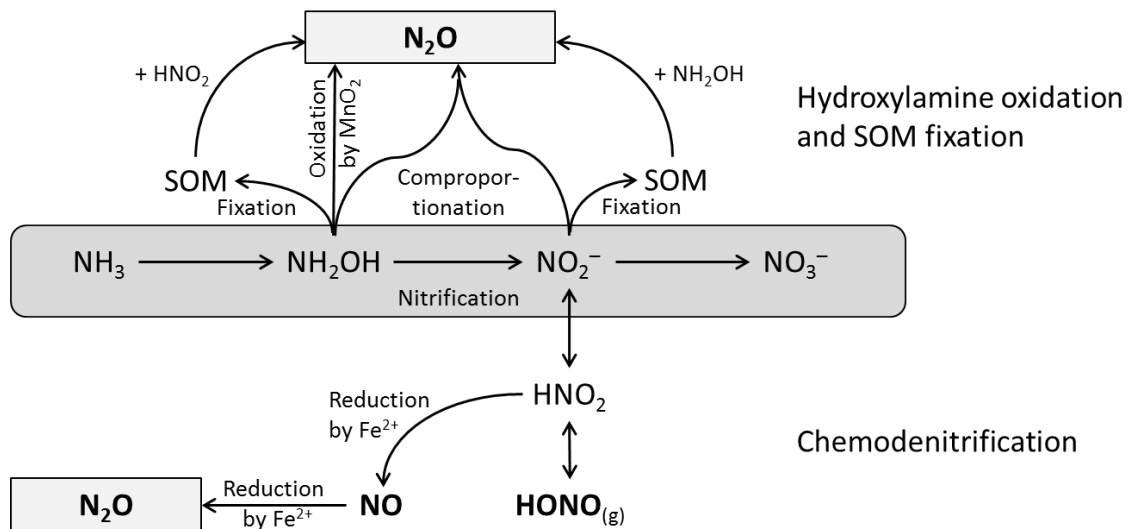

Figure 2.1: Schematic of chemical reactions of nitrification intermediates leading to N₂O formation (SOM = soil organic matter).

2.5. Outlook

This review highlights the tight connection between biotic and abiotic processes in the terrestrial N cycle and likely other biogeochemical cycles. At the same time it demonstrates the challenge to disentangle the diverse processes all competing for N in soil. Experiments with sterilized soils failed to detect abiotic N₂O production because, as this review emphasizes, it involves very likely a coupled biotic–abiotic production mechanism, so that experiments with non-sterile soils are needed to be able to show that chemical N trace gas production from microbiological intermediates is happening, and to define the relative importance of different processes. The greatest issue in studying N trace gas emissions from soils is the identification of the origin of the N trace gas, especially at the field scale. With previous methods it is not possible to separate biotic and abiotic sources and sinks satisfactorily, so that at present it is not possible to clearly determine the contribution of abiotic processes to total N trace gas emission from soils.

While inhibition methods have proven to be not very reliable for specific soil conditions or specific microorganisms, stable isotopes have the greatest potential to overcome this problem (Wrage et al., 2005). Stable isotopes are of great value for determining the importance and regulation of previously ignored pathways, and the use of stable isotope techniques can show that the current view on these processes is over-simplistic (Baggs, 2008). Advances in mass spectrometry and, lately, in laser spectroscopy enable the use of stable isotopes for the differentiation between processes, but techniques need to be further developed to quantify the different processes. A source partitioning is essential for closing the N₂O budget and for understanding controls of processes to develop appropriate mitigation strategies (Baggs, 2008).

One approach is the natural abundance of ^{15}N or ^{18}O in N_2O that has the potential for source partitioning between different processes, but fractionation – especially for biological processes – can differ over a large range of $\delta^{15}\text{N}$ and $\delta^{18}\text{O}$ values. At present, the success is limited by insufficient knowledge on fractionation factors of different pathways (Well and Flessa, 2009), although some advances have been made with respect to N_2O production during denitrification (Lewicka-Szczebak et al., 2015; Rohe et al., 2014). An emerging approach is the site-specific determination of ^{15}N in N_2O , the differentiation between N_2O isotopomers. The site preference (SP) is defined as the difference between the ^{15}N isotope ratio in the central (α) and terminal (β) N atom ($\text{SP} = \delta^{15}\text{N}^\alpha - \delta^{15}\text{N}^\beta$) (Toyoda and Yoshida, 1999). Since the introduction of the method, the source partitioning using isotopomers has been a central research objective. The intramolecular distribution of ^{15}N in N_2O is supposed to reflect the production mechanism rather than the substrate because it is independent from the isotopic signature of the precursor N species (Samarkin et al., 2010; Well et al., 2008). The bulk $\delta^{15}\text{N}$ values for N_2O produced by the different biotic and abiotic reactions are of limited use, as the reactions feed on various N sources and the $\delta^{15}\text{N}$ is affected by the substrate. Yoshida and Toyoda (2000) found that the SP of ^{15}N in N_2O varied significantly throughout the atmosphere, with low SP in the troposphere indicating local emissions. They stated that the SP is a tool with the potential to increase the partitioning of N_2O sources and sinks. Recently, Heil et al. (2014) showed that the SP of N_2O produced from different abiotic NH_2OH oxidation processes was very stable over time and in the same range as N_2O production observed from AOB or AOA. By this, the latest results indicate that the SP can only be used to distinguish between reductive (denitrification and nitrifier denitrification) and oxidative (NH_2OH oxidation, both abiotically and by bacteria and archaea) N_2O production (Decock and Six, 2013). However, there is still insufficient data available, so that more research is required.

This review showed a variety of purely abiotic pathways involved in soil NO and N_2O emissions, being neglected in most studies, although being feasible over a wide range of soil properties. The review also emphasizes the tight coupling between the biotic nitrification and abiotic trace gas production. These processes could have great implications for our general understanding and modeling of N trace gas emissions from soils. However, more research is needed to quantitatively assess the importance of these abiotic pathways at field-scale and ecosystem level.

Chapter 3

Site-specific ^{15}N isotopic signatures of abiotically produced N_2O

Based on:

Heil, J., Wolf, B., Brüggemann, N., Emmenegger, L., Tuzson, B., Vereecken, H. and Mohn, J. (2014) Site-specific ^{15}N isotopic signatures of abiotically produced N_2O . *Geochim. Cosmochim. Acta* **139**, 72-82.

3.1. Introduction

N_2O is a powerful greenhouse gas with an approximately 300 times higher global warming potential than CO_2 . Moreover, N_2O is today's single most important ozone depleting substance (Ravishankara et al., 2009). The atmospheric mixing ratio of N_2O has increased from pre-industrial 270 ppb to 324 ppb in 2011 and is still increasing due to anthropogenic activities, at a rate of 0.8 ppb yr^{-1} (WMO, 2013). Soils, predominantly agricultural soils, are a major source of N_2O , contributing an estimated 50–60% to global N_2O emissions (USEPA, 2010). However, it has recently been observed that soils can also, at least temporarily, function as a significant N_2O sink (Chapuis-Lardy et al., 2007; Goldberg and Gebauer, 2009). Based on top-down estimates, global N_2O emissions can be derived from the stratospheric loss and the atmospheric increase. Still the strength of individual source processes and possible sinks is rather uncertain. This is reflected by the large uncertainty of the bottom-up estimate of global N_2O emissions ranging from 8.5 to $27.7 \text{ Tg N yr}^{-1}$ (Denman et al., 2007). This great uncertainty can be caused by either overestimating N_2O sources or disregarding N_2O sinks (Billings, 2008).

Microbial nitrification and denitrification are considered the major processes responsible for soil N_2O emissions. The N_2O release during both processes has been conceptualized by Firestone and Davidson (1989) in their 'hole-in-the-pipe' model, which attributes N_2O emissions from soils during nitrification and denitrification to a 'leaky' N flow from NH_4^+ to NO_3^- and the incomplete stepwise reduction of nitrate to molecular nitrogen (N_2). Today, the two main processes considered responsible for N_2O production during nitrification are hydroxylamine (NH_2OH) oxidation, i.e., the production of N_2O as a by-product of biological NH_2OH oxidation (Sutka et al., 2003), and nitrifier denitrification, the reduction of nitrite (NO_2^-) by nitrifying bacteria under oxygen-limiting conditions or at elevated NO_2^- concentrations (Wrage et al., 2001). However, abiotic reactions were also identified as potential sources of N_2O (Bremner, 1997). Possible substrates are the two nitrification intermediates NH_2OH and NO_2^- , in the presence of iron compounds or other transition metals. Although these reactions have been known for several years (Bremner et al., 1980), they are neglected in most current nitrogen (N) trace gas studies.

Stable isotope techniques, especially ^{15}N -isotopomer analysis of N_2O , have a great potential to disentangle the different processes leading to N_2O formation. The first site-specific analysis of N_2O produced by the chemical processes NO_2^- reduction and NH_2OH oxidation indicated a constant SP of approximately 30‰ for both reactions (Toyoda et al., 2005). Only recently, Wunderlin et al. (2013) confirmed this finding for abiotic NH_2OH oxidation. However, the SP of N_2O produced via different NH_2OH oxidation pathways and experimental conditions has not yet been studied. Hence, the influence of these factors on the isotopic signature of N_2O is still unknown.

The aim of the present laboratory study was to investigate $\delta^{15}\text{N}^{\text{bulk}}$, $\delta^{18}\text{O}$, and SP values of N_2O formed by different abiotic reactions that could potentially occur in soils under a range of process conditions. Substrates were the nitrification intermediates NH_2OH and NO_2^- that have been shown to produce significant amounts of N_2O . In preliminary experiments those nitrification intermediates have been reacted with each other and iron oxides at different pH levels to observe the production of the N trace gases NO and N_2O using quantum cascade laser absorption spectroscopy. The site-specific isotopic ratios of N_2O from reactions that have shown to produce significant amounts of N_2O were then analyzed in real time using the same technology.

3.2. Materials and Methods

3.2.1. Preliminary experiments

In preliminary experiments reactions were conducted in aqueous solution using deionized water. Solutions contained 1 mM NH_2OH ($\text{NH}_2\text{OH-HCl}$) and, depending the treatment, combinations of 1 mM NO_2^- (NaNO_2), and 2 mM Fe^{3+} ($\text{FeCl}_3 \cdot 6 \text{H}_2\text{O}$) (all chemicals were reagent grade or better and obtained from Merck, Germany). Reaction solutions were either unbuffered or buffered, with citrate buffer for the pH range 3–5, and Tris–maleate buffer for pH 6. Single solutions were mixed in a 250-mL beaker to total up to 100 mL and placed in reaction chambers that were immediately closed afterwards. The custom-made chambers consisted of quartz glass cylinders equipped with PTFE cover plates. The PTFE plates and the quartz glass cylinder were clamped together with seven aluminum rods at the outside of the chamber and the contact surfaces were sealed with Viton O-rings. Uniform mixing of the gas phase inside the chamber was assured with a fan. The chamber volume was 2 L.

The reaction chamber was purged with 3.4 L min^{-1} of dried, pressurized air (Forschungszentrum Jülich GmbH, Germany) controlled by a mass flow controller (MFC, Brooks Instruments, Germany). The sample gas was then split, and one part was directed to a QCLAS (Dual Laser Quantum Cascade Trace Gas Monitor, Aerodyne Research Inc., USA) for N_2O measurement and the other part to a NO chemiluminescence detector (AC32M, Ansyco GmbH, Germany) via PTFE tubing. The QCLAS was operated with two mid-infrared lasers for simultaneous measurements of N_2O , CO_2 , CH_4 , and H_2O concentrations at a high temporal resolution. Water vapor was measured together with the other gases to be able to correct for volumetric dilution and pressure broadening effects due to changing water vapor concentrations in the sample air. Prior to every experiment, the QCLAS was flushed with synthetic air, and a new background spectrum was taken. The instrumental precision of the measurements, given as standard deviation of the average N_2O mixing ratio at atmospheric level, was <0.3 ppb. The chemiluminescence detector was based on the principle of

measuring light emissions from the chemical reaction between NO and ozone. The reaction is selective for NO and linear over a range of 0 to 10000 ppb, which embraced the range of NO mixing ratios during the preliminary experiments. The detector had a detection limit of 1 ppb.

3.2.2. Laboratory setup for isotope-specific N_2O measurements

Reactions were conducted in aqueous solution using ultrapure water (18.2 M Ω cm). All solutions contained NH_2OH ($\text{NH}_2\text{OH}\text{-HCl}$; $\delta^{15}\text{N} = -1.93 \pm 0.11\%$) and, depending on the treatment, combinations of NO_2^- (NaNO_2 ; $\delta^{15}\text{N} = -27.70 \pm 0.08\%$), Fe^{3+} ($\text{FeCl}_3 \cdot 6 \text{H}_2\text{O}$), Fe^{2+} ($\text{FeCl}_2 \cdot 4 \text{H}_2\text{O}$) and Cu^{2+} ($\text{CuSO}_4 \cdot 5 \text{H}_2\text{O}$) (all chemicals were reagent grade or better and obtained from Merck, Germany) (see Table 3.1). Solutions were freshly prepared every day and mixed immediately before measurement. Reaction solutions were either unbuffered or buffered, with phosphate–citrate buffer for the pH range 3–4, and Tris–maleate buffer for the pH range 5–8 (Table 3.1). The pH of the reaction solutions was measured with a pH electrode (SenTix® 81, WTW, Germany), calibrated at pH 4 and 7. Single solutions were mixed in three 250-mL beakers and placed in three replicate reaction chambers that were immediately closed. The same custom-made chambers as in the preliminary experiments were used, but the chamber volume of 2 L was reduced to 500 mL by a polypropylene insert with a recess for a 250-mL beaker.

Table 3.1: Overview of the experiments, experimental conditions, and relevant parameters.

experiment No.	substrates and concentrations	volume [ml]	buffer system	pH
1	NH_2OH 1 mM + NO_2^- 1 mM	100	phosphate–citrate	3.0
2	NH_2OH 1 mM + NO_2^- 1 mM	100	phosphate–citrate	4.0
3	NH_2OH 1 mM + Fe^{3+} 2 mM	100	unbuffered	2.8
4	NH_2OH 1 mM + Fe^{3+} 5 mM	200	Tris–maleate	5.0
5	NH_2OH 1 mM + Cu^{2+} 0.1 mM	100	Tris–maleate	8.0
6	NH_2OH 0.5 mM + NO_2^- 0.5 mM + Fe^{3+} 1 mM	100	unbuffered	2.8
7	NH_2OH 1 mM + NO_2^- 1 mM + Fe^{3+} 2 mM	200	Tris–maleate	5.5
8	NH_2OH 0.25 mM + NO_2^- 0.25 mM + Fe^{3+} 0.5 mM + Fe^{2+} 0.5 mM	100	unbuffered	2.8
9	NH_2OH 2 mM + NO_2^- 2 mM + Fe^{3+} 4 mM + Fe^{2+} 4 mM	200	Tris–maleate	5.5

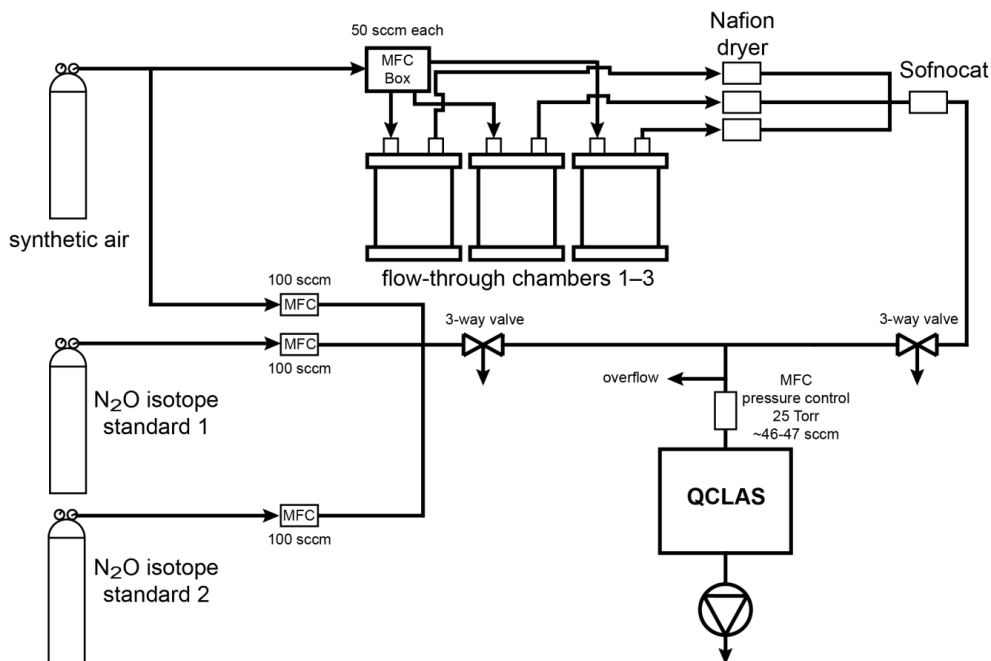

Figure 3.1: Schematic representation of the laboratory setup for the determination of abiotic N_2O production with dynamic flow-through chambers coupled to a quantum cascade laser absorption spectrometer (QCLAS).

As illustrated in Figure 3.1, reaction chambers were purged with 50 mL min^{-1} of high purity synthetic air ($20.5\% \text{ O}_2$ in $79.5\% \text{ N}_2$, purity 99.999%, Messer, Switzerland) controlled by three MFCs (red-y smart series, Vögtlin, Switzerland), via a multi MFC process control unit (PCU 1000, Vögtlin, Switzerland). At the outlet of each chamber, sample gas flows of individual chambers were dehumidified by separate Nafion® permeation dryers (MD-050-72S-1, Perma Pure, USA). The sample gas flows from the three reaction chambers were combined and guided through a Sofnocat® column (9.1 g) to remove traces of CO which would otherwise lead to spectral interferences in the quantum cascade laser absorption spectrometer (QCLAS). The sample gas was then directed to the QCLAS, where a flow of around 46 mL min^{-1} was passing the spectrometer multi-path absorption cell. The approximate flow rate was adjusted with a manual valve at the outlet of the cell, while the exact inflow was controlled by a pressure controller (red-y smart series, Vögtlin, Switzerland) keeping the cell pressure at 33.3 hPa. Switching between measuring and calibration gas was accomplished by two 3-way valves (series 9, Parker Hannifin, USA).

Table 3.2: Summary of the results for the studied abiotic reactions. The uncertainty is given as the standard deviation of the 60-s moving average.

experiment	N ₂ O mixing ratio [ppm]		N turnover [%]		δ ¹⁵ N ^{bulk} [‰]			Δδ ¹⁵ N [‰]	δ ¹⁸ O [‰]			site preference (SP) [%]			
	No.	avg.	max	120min	total	start	end	avg.	start	start	end	avg.	start	end	avg.
1	36.8	117.6		24.2	64.9	-30.5	-19.9	-22.9 ± 2.9	15.7 ^a	42.2	45.0	44.2 ± 1.3	35.1	33.7	34.3 ± 0.4
2	25.1	63.7		12.2	53.8	-32.6	-22.4	-26.9 ± 3.3	17.8 ^a	40.9	44.8	43.6 ± 1.2	34.0	33.5	34.0 ± 0.5
3	37.6	89.2		18.5	18.5	-2.7	3.6	1.4 ± 1.9	0.8	55.2	64.1	60.2 ± 2.3	34.6	32.2	34.1 ± 0.4
4	23.6	41.4		8.0	15.6	-23.0	-19.1	-21.7 ± 0.9	21.1	31.8	38.0	33.9 ± 1.2	35.1	35.9	34.9 ± 0.4
5	39.4	53.9		19.4	19.4	-7.2	-19.3	-15.1 ± 4.0	5.3	44.6	65.0	56.3 ± 6.5	34.7	33.9	34.4 ± 0.3
6	20.4	88.0		20.5	42.1	-14.2	-14.6	-14.4 ± 0.1	-0.6 ^a	49.3	51.5	50.2 ± 0.6	34.2	36.8	35.2 ± 0.6
7 ^b	6.2	8.4		0.9	3.3	-19.6	-23.5	-22.5 ± 1.2	4.8 ^a	33.6	44.1	39.3 ± 3.3	34.7	34.1	34.6 ± 0.8
8	25.2	46.8		24.9	24.9	-14.0	-13.1	-13.8 ± 0.5	-0.8 ^a	49.1	50.9	50.0 ± 0.4	35.5	38.0	35.6 ± 0.1
9	17.4	20.1		0.9	4.6	-18.2	-22.9	-22.7 ± 0.2	3.4 ^a	39.4	48.2	45.7 ± 1.5	34.4	33.7	33.9 ± 0.3

^a in experiments with two N substrates a 1:1 reaction between the educts was assumed and the average of the δ¹⁵N of the educts used to calculate Δδ¹⁵N

^b concentrations in this experiment were below the calibration limit

3.2.3. Instrumentation

The employed laser spectrometer (custom-made, Aerodyne Research Inc., USA) was based on continuous wave quantum cascade laser (cw-QCL) technology, and was originally developed for high precision NO_x measurements (Tuzson et al., 2013). For the measurement of N_2O isotopologues, the QCL was replaced, the optics optimized and the software reconfigured. Major improvements over the spectrometer previously reported for N_2O isotopic analysis (Waechter et al., 2008) include: a) optimally selected spectral range around 2203 cm^{-1} , which allows for the first time the simultaneous quantification of the four most abundant N_2O isotopologues ($^{14}\text{N}^{14}\text{N}^{16}\text{O}$, $^{15}\text{N}^{14}\text{N}^{16}\text{O}$, $^{14}\text{N}^{15}\text{N}^{16}\text{O}$, and $^{14}\text{N}^{14}\text{N}^{18}\text{O}$); b) increased sensitivity due to cw operation of the QCL (Alpes Lasers, Switzerland) and employing a longer astigmatic Herriott multi-pass absorption cell (204 m path length, AMAC-200, Aerodyne Research Inc., USA); and c) a reference path with a short (5 cm) N_2O -filled cell to lock the laser emission frequency to well-defined absorption lines.

The spectrometer was operated in a flow-through mode and mixing ratios of N_2O isotopologues were measured at 1 Hz temporal resolution. For N_2O mixing ratios of 50 ppm and a cell pressure of 3.3 kPa the spectrometer enables high precision ($< 0.05\text{‰}$) analysis of $\delta^{15}\text{N}^\alpha$, $\delta^{15}\text{N}^\beta$, and $\delta^{18}\text{O}$ with 450 s spectral averaging. The 1-s precision for delta values is $< 0.6\text{‰}$. This is a factor 2–3 superior to our previously published results (Mohn et al., 2010; Mohn et al., 2012). The multi-pass cell was flushed with synthetic air every three hours to record a new background spectrum. For this period no measurement data are available. The spectroscopically determined isotope ratios were related to the international isotope ratio scales (air- N_2 for $^{15}\text{N}/^{14}\text{N}$, VSMOW for $^{18}\text{O}/^{16}\text{O}$) through analysis of calibration gases before and after every experiment. Calibration gases were prepared in the laboratory at EMPA based on gravimetric and dynamic dilution methods from pure medical N_2O (Messer, Switzerland) supplemented with distinct amounts of isotopically pure $^{15}\text{N}^{14}\text{N}^{16}\text{O}$, $^{14}\text{N}^{15}\text{N}^{16}\text{O}$ ($> 98\%$, Cambridge Isotope Laboratories, USA) and $^{14}\text{N}^{14}\text{N}^{16}\text{O}$ ($> 99.95\%$, ICON Services, USA). Primary calibration gases have been analyzed for $\delta^{15}\text{N}^\alpha$, $\delta^{15}\text{N}^\beta$, $\delta^{18}\text{O}$ by IRMS at Tokyo Institute of Technology (Toyoda and Yoshida, 1999). Additionally, comparability of our results with IRMS for $\delta^{15}\text{N}^\alpha$ and $\delta^{15}\text{N}^\beta$ has been demonstrated in an inter-comparison approach (Köster et al., 2013). The N_2O turnover was calculated from total N_2O emissions and N input.

The abundances of different isotopic species are reported in the δ -notation. The $\delta^{15}\text{N}$ bulk value is defined as $\delta^{15}\text{N}^{\text{bulk}} = (\delta^{15}\text{N}^\alpha + \delta^{15}\text{N}^\beta)/2$, where $\delta^{15}\text{N}^\alpha$ denotes the relative ^{15}N abundance at the central ($^{14}\text{N}^{15}\text{N}^{16}\text{O}$) and $\delta^{15}\text{N}^\beta$ at the terminal N position ($^{15}\text{N}^{14}\text{N}^{16}\text{O}$) of the asymmetric N_2O molecule (Brenninkmeijer and Röckmann, 1999; Toyoda and Yoshida, 1999). The SP is defined as difference in isotope deltas at central and terminal position $\delta^{15}\text{N}^\alpha - \delta^{15}\text{N}^\beta$. The net N isotope effect (NIE) is the difference in $\delta^{15}\text{N}$ between the relevant substrate and the released N_2O and was approximated as $\Delta\delta^{15}\text{N} = \delta^{15}\text{N}_{\text{substrate}} - \delta^{15}\text{N}^{\text{bulk}}$ (Sutka et al., 2003).

The first 15 min of each experiment were discarded due to mixing with ambient air from the chambers. Averages of isotopic delta values were calculated for the first 5 min after that period, for the last 5 min, as well as over the complete experimental run. The NIE was only calculated for the initial 5 min of the experiment after the discarded period. N_2O threshold mixing ratios for the use of isotope data were 18 ppm as lower and 90 ppm as upper boundary, respectively. Measurement uncertainties were calculated as the standard deviation of the 60-s moving average.

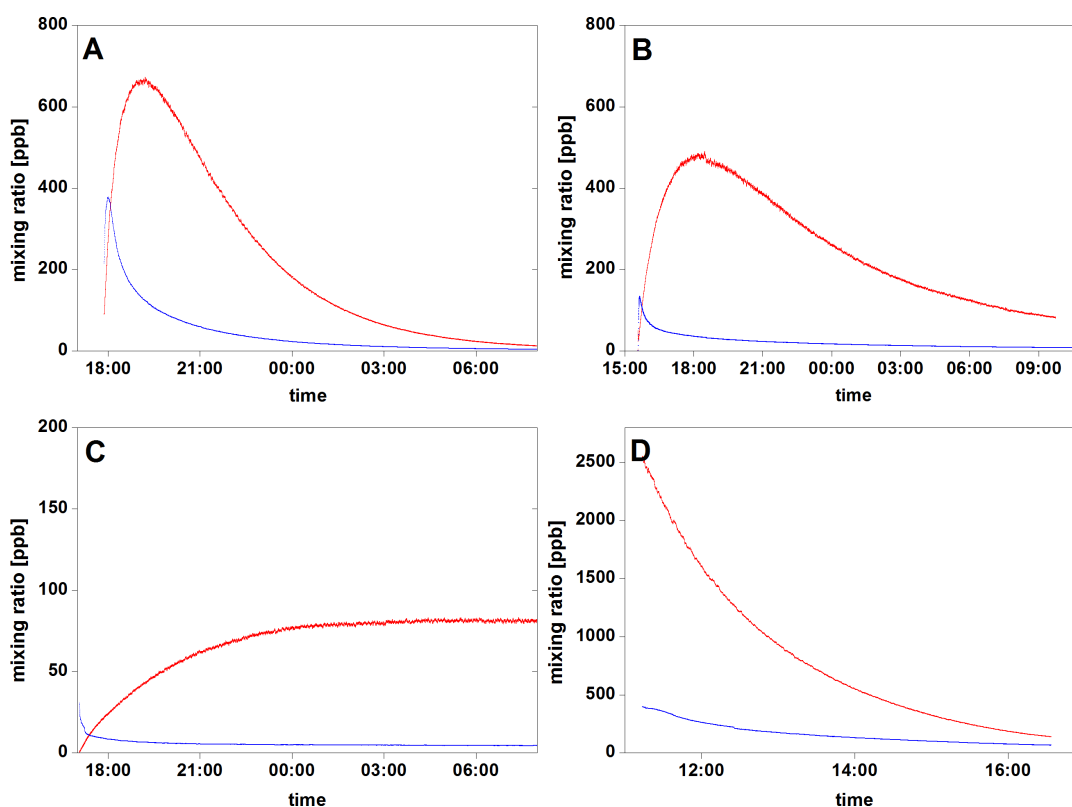

Figure 3.2: Mixing ratios of N_2O (red line) and NO (blue line) produced by the abiotic reaction between 1 mM NH_2OH and 1 mM NO_2^- buffered (citrate buffer) (A) at pH 3, (B) at pH 4, (C) at pH 5, and (D) unbuffered (pH 3.4) with the addition of 2 mM Fe^{3+} ; All values are 1 Hz data.

3.3. Results

3.3.1. NO and N_2O production from nitrification intermediates NH_2OH and NO_2^-

The first N trace gas production reactions studied were the reaction between NH_2OH and NO_2^- at different pH levels, and additionally in the presence of Fe^{3+} (Fig. 3.2). The reaction between NH_2OH and NO_2^- buffered at pH 3 (Fig. 3.2a) resulted in a strong NO and N_2O production right at the beginning of the experiment. NO mixing ratios reached the maximum only a few minutes after the onset of the reaction at 398 ppb. N_2O mixing ratios increased for about one hour until a maximum of about 680 ppb was reached. After reaching their peak values, both mixing ratios decreased slowly for the rest of the experiment and approached zero after approximately 15 h. The same reac-

tion at pH 4 changed the kinetics of the NO and N_2O production (Fig. 3.2b). NO production also reached the maximum several minutes after start of the experiment, but at a lower value of only 133 ppb. The N_2O production kinetics were also different, with a lower maximum (490 ppb), but a longer tailing with N_2O mixing ratios still at about 30 ppb after 18 h. At pH 5 (Fig. 3.2c), the same reaction resembled completely different kinetics that resulted in a low but constant production of NO and N_2O after an initial small NO peak and an initial slow increase of N_2O mixing ratios. The final mixing ratios of NO and N_2O at the end of the experiment, after 15 h, were 4 and 88 ppb, respectively. The addition of Fe^{3+} to the two nitrification intermediates NH_2OH and NO_2^- , unbuffered at pH 3.4, changed the kinetics of NO and N_2O productions dramatically (Fig. 3.2d). The reaction showed an immediate production of both NO and N_2O , with the maximum value reached right after the beginning of the experiment. The N_2O maximum was also much higher, at about 2850 ppb, than previously observed without the addition of Fe^{3+} . The maximum value of NO (398 ppb) was at the same level as without Fe^{3+} addition at pH 3.

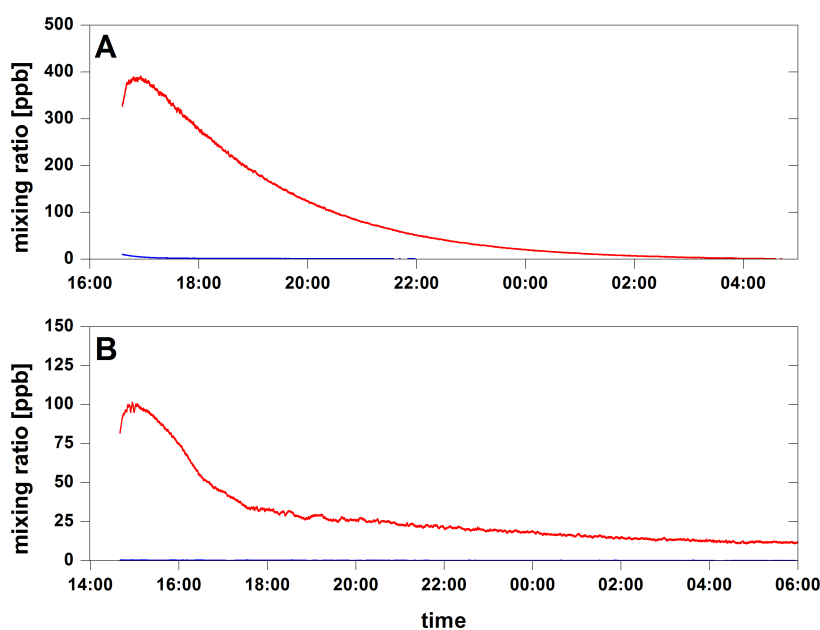

Figure 3.3: Mixing ratios of N_2O (red line) and NO (blue line) produced by the abiotic reaction between 1 mM NH_2OH and 2 mM Fe^{3+} , (A) unbuffered at pH 3.4 and (B) buffered (Tris-maleate) at pH 6; All values are 1 Hz data.

Experiments in the absence of NO_2^- , demonstrating the reaction between NH_2OH and a redox-active transition metal, in particular Fe^{3+} , are presented in Figure 3.3. In unbuffered solution, the reaction was associated with high N_2O formation that led to a maximum N_2O mixing ratio of about 390 ppb only 15 min after the onset of the experiment (Fig. 3.3a). Thereafter, the N_2O mixing ratio decreased until no more N_2O formation was observed after 10 h. Buffered at pH 6, the same reaction showed similar kinetics, however, the observed maximum was about four times lower (Fig.3.3b). In both experiments no significant NO formation was observed.

3.3.2. Isotopic signatures of abiotically produced N_2O

The first mechanism of abiotic N_2O production studied was the reaction between NH_2OH and NO_2^- at pH 3 and 4 (experiments 1 and 2 in Table 3.1). Both reactions resulted in a considerable N_2O production with a higher N_2O yield and maximum mixing ratio at the lower pH (Table 3.2). In Figure 3.4, N_2O mixing ratios and isotopic composition are given for the reaction at pH 4. At the onset of the experiment a fast increase in the N_2O mixing ratio from ambient to 64 ppm was observed, followed by a steady decline to 6 ppm within the following 17 h (Fig. 3.4a). Within this period, about 50% of the added N had been converted to N_2O -N (Table 3.2). The strong increase of N_2O mixing ratios in the headspace of the chamber in the beginning co-occurred with a decrease of $\delta^{15}\text{N}^{\alpha}$ and $\delta^{15}\text{N}^{\beta}$ (Fig. 3.4b), caused by mixing of newly formed N_2O with ambient N_2O (324 ppb, $\delta^{15}\text{N}^{\text{bulk}} = 6.6\text{‰}$, $\delta^{18}\text{O} = 44.2\text{‰}$, $\text{SP} = 18\text{‰}$; Toyoda et al., 2013) that was present in the reaction chamber during closure. This initial decrease in $\delta^{15}\text{N}^{\alpha}$ and $\delta^{15}\text{N}^{\beta}$ was followed by a constant increase in both isotope deltas, due to a constant enrichment of the substrate in ^{15}N due to kinetic fractionation. As $\delta^{15}\text{N}^{\alpha}$ and $\delta^{15}\text{N}^{\beta}$ became enriched at the same rate, their difference, i.e., the SP, remained constant (Fig. 3.4d). The consistency of SP at $34.3 \pm 0.4\text{‰}$ (experiment 1) and $34.0 \pm 0.5\text{‰}$ (experiment 2) was not affected by an increase in the measurement uncertainty with decreasing N_2O mixing ratios. The NIE was calculated from the average $\delta^{15}\text{N}$ of the two N substrates and the $\delta^{15}\text{N}^{\text{bulk}}$ of initially emitted N_2O . It was slightly higher for the reaction at pH 4 (17.8‰) than at pH 3 (15.7‰), which could be explained by the lower reaction rate at higher pH. A similar, yet less pronounced behavior as for $\delta^{15}\text{N}$ was observed for $\delta^{18}\text{O}$, with a moderate rise of 3.9‰ over the experiment after a strong increase in the first 10 min (Fig. 3.4c).

The second abiotic N_2O production mechanism analyzed was the oxidation of NH_2OH with Fe^{3+} in unbuffered solution as well as in solution buffered at pH 5 (experiments 3 and 4 in Table 3.1 and 3.2). The experiment in unbuffered solution yielded higher maximum N_2O mixing ratios and a faster N turnover rate and led to a minor ^{15}N isotopic fractionation. For the experiment with Tris-maleate buffer (Fig. 3.5), a rapid increase of N_2O mixing ratio up to 41 ppm was observed within 40 min after the start of the experiment, followed by a slow decrease to 11 ppm after 5 h. Within these 5 h, 16% of the added N substrate had been transformed to N_2O (Table 3.2). The $\delta^{15}\text{N}^{\alpha}$ and $\delta^{15}\text{N}^{\beta}$ values showed a slow but steady increase of 3.5‰ during the experiment (Fig. 3.5b). A similar behavior was also observed for $\delta^{18}\text{O}$ values (Fig. 3.5c), while the SP averaged at $34.9 \pm 0.4\text{‰}$ (Fig. 3.5d). The NIE for the buffered experiment was 21.1‰, while it was significantly lower for the unbuffered experiment (0.8‰) as explained above (Table 3.2).

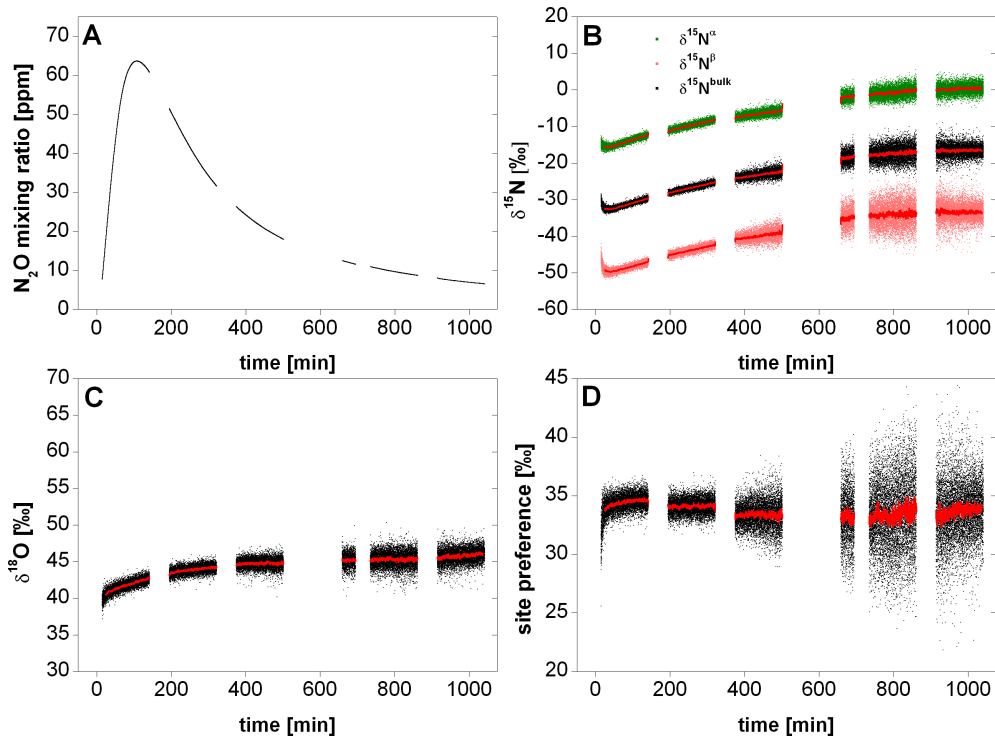

Figure 3.4: Results of the isotopic analysis of N_2O produced by the abiotic reaction between 1 mM NH_2OH and 1 mM NO_2^- , buffered at pH 4 (citrate–phosphate buffer): N_2O mixing ratio in ppm (A), $\delta^{15}\text{N}^{\text{bulk}}$, $\delta^{15}\text{N}^{\alpha}$, and $\delta^{15}\text{N}^{\beta}$ of N_2O (B), $\delta^{18}\text{O}$ of N_2O (C), and the N_2O site preference (SP) (D); All values are 1 Hz data, red lines show the 60 s moving average.

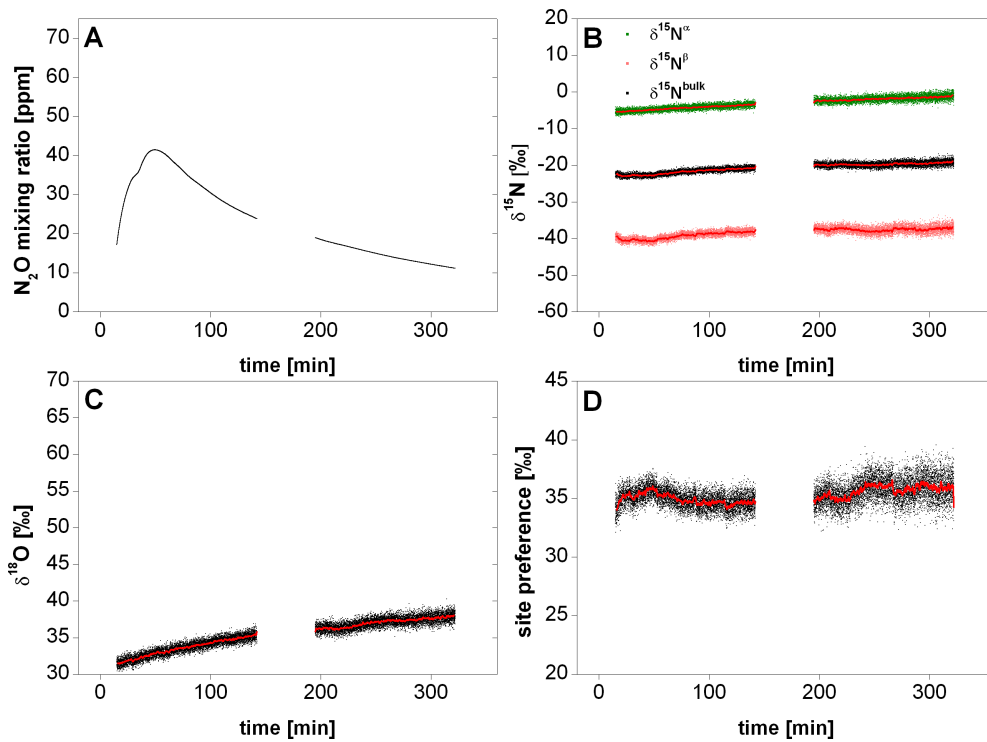

Figure 3.5: Results of the isotopic analysis of N_2O produced by the abiotic reaction between 1 mM NH_2OH and 5 mM Fe^{3+} buffered at pH 5 (Tris–maleate buffer): N_2O mixing ratio in ppm (A), $\delta^{15}\text{N}^{\text{bulk}}$, $\delta^{15}\text{N}^{\alpha}$, and $\delta^{15}\text{N}^{\beta}$ of N_2O (B), $\delta^{18}\text{O}$ of N_2O (C), and the N_2O site preference (SP) (D); All values are 1 Hz data, red lines show the 60 s moving average.

The last reaction mechanism investigated was the autoxidation of NH_2OH catalyzed by Cu^{2+} at pH 8 (Fig. 3.6; experiment 5 in Table 3.1 and 3.2). This third reaction led also to a fast increase in N_2O mixing ratios to a maximum of 54 ppm after 50 min, before it rapidly declined to 19 ppm within another 90 min (Fig. 3.6a). The NH_2OH conversion rate to N_2O was 19% within this period. The initially emitted N_2O was depleted in ^{15}N as compared to the NH_2OH substrate ($\Delta\delta^{15}\text{N} = 5.3\text{‰}$). Both $\delta^{15}\text{N}^\alpha$ and $\delta^{15}\text{N}^\beta$ steadily decreased afterwards, once ambient air had been flushed out of the chamber. As both $\delta^{15}\text{N}^\alpha$ and $\delta^{15}\text{N}^\beta$ decreased at the same rate, the SP remained constant at $34.4 \pm 0.3\text{‰}$ (Fig. 3.6d). The $\delta^{18}\text{O}$ of N_2O showed a rapid increase during the whole experiment by over 20‰ to a maximum of 65‰, much higher than in the other reactions (Fig. 3.6c).

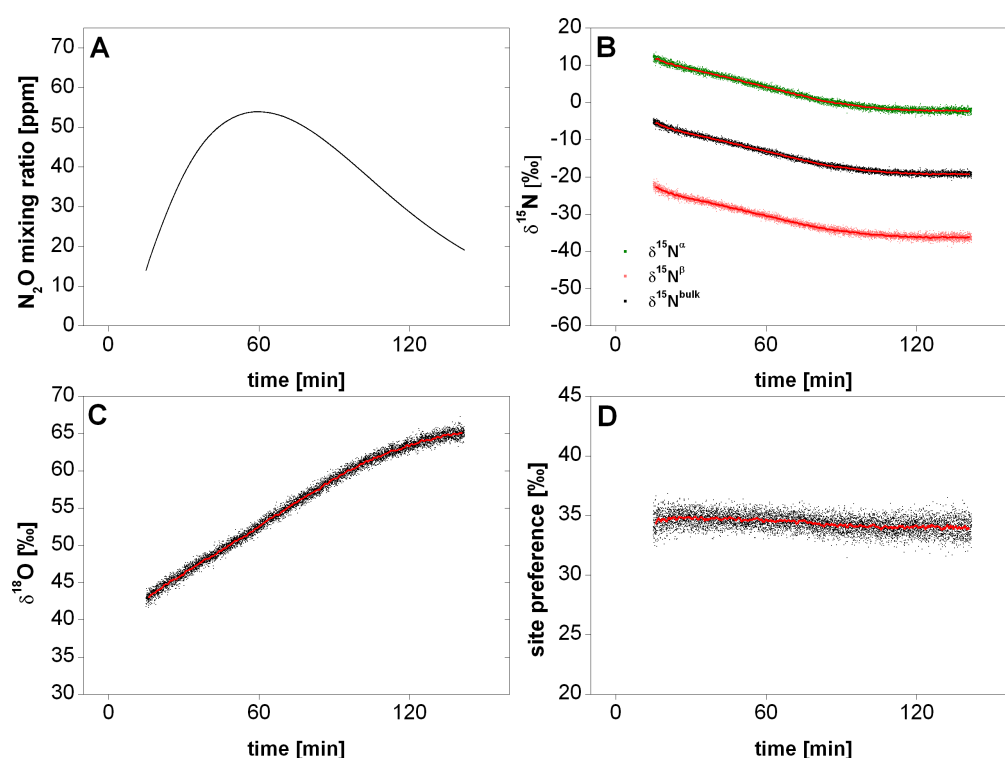

Figure 3.6: Results of the isotopic analysis of N_2O produced by abiotic autoxidation of 1 mM NH_2OH catalyzed by 0.1 mM Cu^{2+} buffered at pH 8 (Tris–maleate buffer): N_2O mixing ratio in ppm (A), $\delta^{15}\text{N}^{\text{bulk}}$, $\delta^{15}\text{N}^\alpha$, and $\delta^{15}\text{N}^\beta$ of N_2O (B), $\delta^{18}\text{O}$ of N_2O (C), and the N_2O site preference (SP) (D); All values are 1 Hz data, red lines show the 60 s moving average.

Ternary and quaternary unbuffered reaction mixtures (experiments 6 and 8, Table 3.1) with two possible reaction mechanisms, i.e., the reaction of NH_2OH with NO_2^- and the oxidation of NH_2OH by Fe^{3+} , led to a fast and sharp increase in N_2O production. Due to the addition of Fe^{3+} , the solution was acidic with a pH of 2.8. Although the concentration of both N substrates was only half or a quarter of experiments 1 to 5, 15 min after the start the maximum N_2O mixing ratio peaked at 88 ppm in experiment 6. However, the N turnover to N_2O within the first 2 h (20.5%) was slightly lower compared to the reaction between NH_2OH and NO_2^- at a similar pH (experiment 1; 24.2%;

Table 3.2). The $\delta^{15}\text{N}^{\text{bulk}}$ of N_2O emitted at the onset of the experiment was similar to the average ^{15}N content of the two N substrates ($\Delta\delta^{15}\text{N} = -1.4$). Nevertheless, one has to consider that $\Delta\delta^{15}\text{N}$ is only indicative for reactions involving both N substrates, as N_2O production could also be from NH_2OH only.

In experiment 8, the combined influence of Fe^{2+} and Fe^{3+} on the reaction between NH_2OH and NO_2^- was investigated in unbuffered solution. Concentrations of both N substrates were half compared to experiment 6. The maximum observed N_2O mixing ratio was also nearly half at 47 ppm. There was no significant difference between $\delta^{15}\text{N}$ and $\delta^{18}\text{O}$ of N_2O produced in experiments 6 and 8, and in both experiments only a marginal isotopic fractionation was observed assuming a 1:1 reaction of NH_2OH and NO_2^- as N_2O educts. The reaction in the presence of both Fe^{2+} and Fe^{3+} had a slightly higher N turnover within the first 2 h of the experiment (24.9%) as compared to experiment 6 with Fe^{3+} alone (20.5%).

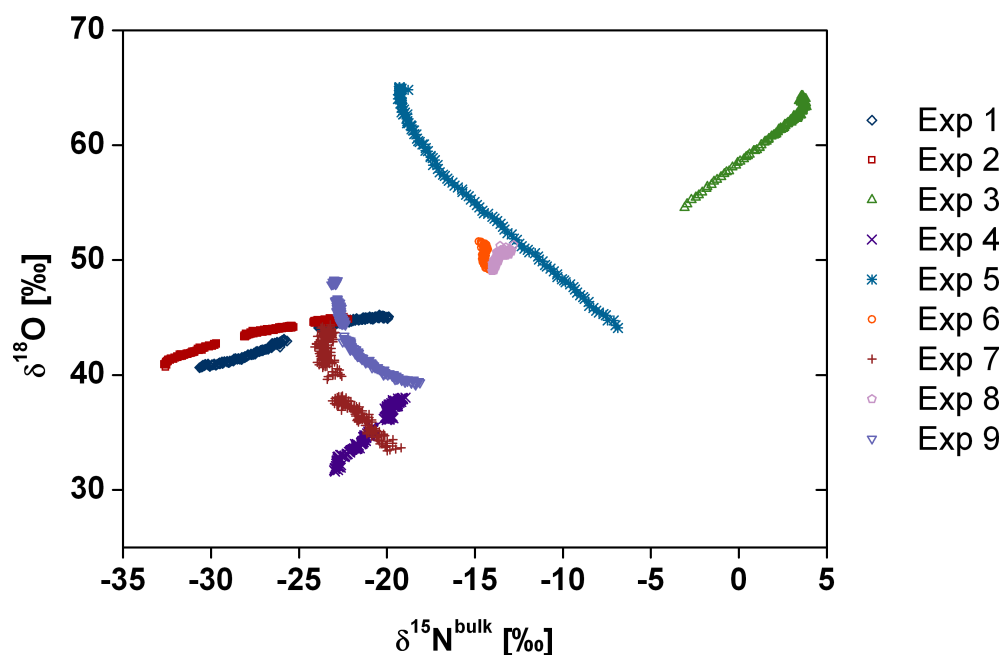

Figure 3.7: Relationship between all 1-min average $\delta^{15}\text{N}^{\text{bulk}}$ and $\delta^{18}\text{O}$ values of the produced N_2O of all experiments.

In buffered solution (pH 5.5), the results of the reaction of NH_2OH and NO_2^- with Fe^{3+} and with $\text{Fe}^{2+}/\text{Fe}^{3+}$, respectively (experiments 7 and 9, Table 3.1), were completely different from those of the unbuffered reactions (experiments 6 and 8). Although N substrate concentrations and solution volume were higher, N_2O production was much lower (Table 3.2). Also the kinetics of the buffered reactions was completely different from the unbuffered reactions. In experiment 7, an increase in N_2O mixing ratio in the headspace up to 8.4 ppm after 45 min was observed, followed by a slow gradual decrease. In experiment 9 the initial fast increase was followed by a very slow but succes-

sive increase until the end of the experiment after 500 min. $\delta^{15}\text{N}^{\alpha}$ and $\delta^{15}\text{N}^{\beta}$ for experiments with or without Fe^{2+} addition showed a similar behavior with minor isotopic fractionation at the onset ($\Delta\delta^{15}\text{N} = 4.8\%$, experiment 7; $\Delta\delta^{15}\text{N} = 3.4\%$, experiment 9). In the course of the experiment $\delta^{15}\text{N}^{\alpha}$ and $\delta^{15}\text{N}^{\beta}$ gradually decreased by around 5%. In addition, both experiments were characterized by a very low N turnover rate in the first 2 h of 0.9%.

The 1-min averages of the $\delta^{15}\text{N}^{\text{bulk}}$ and $\delta^{18}\text{O}$ values plotted against each other showed a strong relationship between the two delta values for all individual experiments (Fig. 3.7). N_2O produced by the different abiotic reactions showed a linear correlation between $\delta^{15}\text{N}^{\text{bulk}}$ and $\delta^{18}\text{O}$ in dependence on the reaction time, those relationships, however, differed completely between different experiments, showing the great variability in fractionation between the different reactions, although all were abiotic NH_2OH oxidations. Only same reactions in the same buffer medium showed similar fractionation patterns (experiment 1 and 2).

3.4. Discussion

3.4.1. NO and N_2O production from nitrification intermediates NH_2OH and NO_2^-

Preliminary experiments have shown that reactions involving the nitrifications intermediates NH_2OH and NO_2^- can lead to the production of N trace gases NO and N_2O (Fig. 3.2 and 3.3). The production of NO was restricted to reactions involving NO_2^- , while in the absence of NO_2^- no NO formation could be observed. NO formation was further restricted to low pH levels, as an increase in pH led to a sharp decline in NO formation. The addition of Fe^{3+} to the reaction did not enhance NO formation, as NO formation with added Fe^{3+} was similar to the NO formation without Fe^{3+} at a similar pH. The strong pH dependency of the observed NO formation can be explained by the fact that HNO_2 rather than NO_2^- is the reactive species in the self-decomposition of NO_2^- which leads to the production of NO (van Cleemput and Samater, 1996). Due to the protonation of NO_2^- to HNO_2 ($\text{pK}_a = 3.3$) the reaction became very slow at pH 5, as the equilibrium between HNO_2 and NO_2^- shifts towards the NO_2^- side. NO_2^- is stable above pH 5.5 (van Cleemput and Baert, 1978), so that an abiotic NO formation in soils seems to be restricted to acidic ecosystems, as e.g., coniferous forests (Stange et al., 2000).

N_2O formation, however, could only be observed in the presence of NH_2OH . Two N_2O production mechanisms could be observed, the reaction between NH_2OH and NO_2^- and the oxidation of NH_2OH by a transition metal. Like in the abiotic formation of NO, HNO_2 was the reactive species in the reaction with NH_2OH . The reaction showed the same pH dependency as the self-decomposition of NO_2^- , so that this pathway is also limited to acidic soils. As HNO_2 is involved in both, abiotic NO and N_2O formation, both reactions are competing for HNO_2 . After an initial peak

in NO formation abiotic N_2O production becomes the dominant pathway, so that the reaction with NH_2OH seems to be the preferred or faster reaction when both precursors are available. An even higher and faster formation of N_2O was observed when Fe^{3+} was added to the NO_2^- and NH_2OH reaction. N_2O production from the oxidation of Fe^{3+} could also be observed in the absence NO_2^- , albeit at a lower level. These results are in conjunction with Minami and Fukushi (1986) and Bremner et al. (1980) who found the oxidation of NH_2OH by transition metals to be faster than the reaction between NH_2OH and NO_2^- . Also buffers were found to attenuate the reaction with Fe^{3+} , the reaction could potentially be of more relevance, as it is possible over a larger pH range than the reaction with NO_2^- .

Based on the above results, the assumption that reactions involving NH_2OH lead to the formation of N_2O and reactions only involving NO_2^- lead to the formation of mainly NO as postulated by Bremner (1997) could be confirmed. Abiotic NO formation from NO_2^- self-decomposition as in classical chemodenitrification could potentially play a role in acidic soils, while abiotic N_2O can be hypothesized to be feasible over a wider pH range with NH_2OH as the key component in the formation.

3.4.2. Comparison of reaction mechanisms

The average $\delta^{15}\text{N}^{\text{bulk}}$ of N_2O produced in all abiotic reactions studied ranged between -26.9 and 1.4‰ (Table 3.2). It reflected the $\delta^{15}\text{N}$ of the substrate partially, hence the information obtained from $\delta^{15}\text{N}^{\text{bulk}}$ of emitted N_2O to identify the N substrate is not straightforward, and the use of $\delta^{15}\text{N}^{\text{bulk}}$ to identify the N substrate may be limited. Reactions involving NO_2^- produced N_2O with the lowest $\delta^{15}\text{N}^{\text{bulk}}$, which could be attributed to the low $\delta^{15}\text{N}$ of the substrate, but reactions with NH_2OH as the only N substrate yielded N_2O with a $\delta^{15}\text{N}^{\text{bulk}}$ nearly as low. The reason for this is a variable degree of fractionation in favor of the lighter isotope for different reaction pathways, which is mirrored by the NIE covering a range of -0.8 to 21.1‰ and strongly depending on experimental conditions (e.g., buffer medium and pH) for certain pathways (Table 3.2). Correspondingly, fractionation was lowest in the unbuffered experiments but much higher in experiments e.g. with citrate-phosphate buffer, although both were associated with high N_2O production rates.

The decomposition of NH_2OH catalyzed by Cu^{2+} could clearly be distinguished from the pattern of the other reactions, as it showed an inverse fractionation pattern with N_2O getting lighter in ^{15}N over time. This may be attributed to one of the complex intermediate formation steps, such as fractionation during dimerization in favor of a $^{15}\text{N}-^{14}\text{N}$ bond as discussed below.

The average $\delta^{18}\text{O}$ of N_2O in the different experiments showed a similar order and spanned a similar range as $\delta^{15}\text{N}^{\text{bulk}}$, with average values between 33.9 and 60.2‰ (Table 3.2). The same substrates in buffered or unbuffered medium led to significantly different $\delta^{18}\text{O}$ values, whereas the same sub-

strate in the same buffer medium, but at different pH, produced similar $\delta^{18}\text{O}$ values (experiments 1 and 2). Values were highest for unbuffered experiments, while reactions in citrate–phosphate buffer produced intermediate and those in Tris–maleate buffer the lowest $\delta^{18}\text{O}$ values. A steady increase in $\delta^{18}\text{O}$ was observed in all experiments as reactions proceeded, which is consistent with Rayleigh fractionation behavior. The interpretation of $\delta^{18}\text{O}$ values might be complicated by possible, buffer-dependent exchange of O between water and NO_2^- , while no exchange is assumed for NH_2OH (Kool et al., 2011). However, there was again one exception from this pattern, i.e., the autoxidation of NH_2OH catalyzed by Cu^{2+} , which showed high $\delta^{18}\text{O}$ values and the largest increase in $\delta^{18}\text{O}$. Figure 3.7 additionally illustrates the great variability in $\delta^{18}\text{O}$, as well as in $\delta^{15}\text{N}^{\text{bulk}}$ fractionation, between the different experiments, although relationships between the two delta values were found for each individual experiment, which is in agreement with Schmidt et al. (2004a) who found a correlation of both delta values as a function of reaction time or turnover for the NH_2OH oxidation with *Nitrosomonas europaea*.

The combined reaction between NH_2OH , NO_2^- , and iron in unbuffered solution (experiments 6 and 8) resulted in similar kinetics as the reaction between NH_2OH and Fe^{3+} in an unbuffered medium, yet the $\delta^{15}\text{N}^{\text{bulk}}$ of N_2O gave no indication about the N substrate and revealed no isotopic fractionation during the experiment. The N turnover in the first 120 min was similar to experiments 1–4, yet the maximum N_2O mixing ratio in experiment 6 was at a similar level, although NH_2OH concentration was only half as compared to experiments 1–4. This could have had different reasons: two reaction mechanisms occurring simultaneously and leading to higher N_2O production than both mechanisms alone, and the experiment being conducted in an unbuffered medium. In buffered solution, the buffer anion had a considerable influence on reactions involving Fe^{3+} , most probably by building iron complexes, which reduced the free iron concentration, thus preventing a reaction with NH_2OH .

There was no indication for a different reaction mechanism caused by the addition of Fe^{2+} . In previous studies, the reaction between NH_2OH and NO_2^- had been shown to be second-order (Döring and Gehlen, 1961) and the oxidation of NH_2OH by Fe^{3+} to be pseudo-first-order with respect to NH_2OH and Fe^{3+} concentration (Butler and Gordon, 1986). Most likely, Fe^{2+} was immediately oxidized to Fe^{3+} , leading to a higher overall N turnover. The proportionally higher Fe^{3+} concentration as compared to the N substrate in experiment 8 vs. experiment 6 probably enhanced the reaction velocity and could have made up for part of the kinetic effect of the lower N substrate concentration, making the reaction appear first-order.

There were probably two reasons leading to slow kinetics in experiments 7 and 9 in buffered medium as compared to experiments 6 and 8 in unbuffered solution: (a) a higher pH slowing down the reactions of NH_2OH with NO_2^- and/or with Fe^{3+} (Butler and Gordon, 1986; van Cleemput and Samater, 1996), and (b) buffer anions forming very stable or even insoluble iron complexes, re-

stricting the reactivity of Fe^{3+} . Further experiments showed that the oxidation of NH_2OH by Fe^{3+} is suppressed in buffered solution independent of pH (data not shown). N_2O production in experiments 7 and 9 seemed to be determined by the slow degree of protonation of NO_2^- – the process that forms HNO_2 ($\text{pK}_a = 3.3$) – at pH 5.5, as not NO_2^- , but HNO_2 is the reactant in the reaction of NH_2OH and NO_2^- .

3.4.3. Comparison with other studies

The observed ^{15}N site preference of N_2O formed in the abiotic reactions of this study was in a similar range to recent studies reporting on N_2O production via microbial NH_2OH oxidation. In batch pure culture studies, SP values of $33.5 \pm 1.2\text{‰}$, $32.5 \pm 0.6\text{‰}$, $35.6 \pm 1.4\text{‰}$, and $30.8 \pm 5.9\text{‰}$ had been observed for *Nitrosomonas europaea*, *Nitrosomonas multiformis*, *Methylosinus trichosporium*, and *Methylococcus capsulatus*, respectively (Sutka et al., 2006; Sutka et al., 2003, 2004). For marine environments (*Nitrosomonas marina* C-113a) a SP of $36.3 \pm 2.4\text{‰}$ was found (Frame and Casciotti, 2010). Recently, Santoro et al. (2011) reported a SP of N_2O from marine AOA that was in the same range as for abiotically produced N_2O (30.3‰). In a recent mixed culture experiment the SP of N_2O ranged from 26.4 to 30.7‰ at conditions where NH_2OH oxidation was expected to be the dominant N_2O producing process (Wunderlin et al., 2013). However, in mixed population systems additional pathways cannot be completely excluded and may have led to a lower SP (Wunderlin et al., 2013). The SP of N_2O produced abiotically via NH_2OH oxidation had been determined for the first time by Toyoda et al. (2005). In a laboratory experiment with addition of MnO_2 to a NH_2OH solution, the authors found a SP of $29.5 \pm 1.1\text{‰}$. Wunderlin et al. (2013) observed a similar SP by adding NH_2OH to tap water (SP $30.3 \pm 0.2\text{‰}$) in a batch reactor. Both studies confirm a constant SP for N_2O produced by abiotic reactions as found in this study, although their results are about 4–5‰ lower than the average SP obtained in this study. Additionally, this study showed for the first time that the SP was constant during all reaction stages for different reaction mechanisms and process conditions.

3.4.4. Mechanism leading to high positive SP

In the present study, a characteristic, strongly positive SP was observed for N_2O formation via NH_2OH oxidation. The exact reaction mechanism is unknown, but it is hypothesized that the high positive SP is indicative of a mechanism via a symmetric intermediate, presumably *cis*-hyponitrous acid ($\text{HO}-^{14}\text{N}=\text{N}-^{15}\text{N}-\text{OH}$) or rather its anion *cis*-hyponitrite ($^-\text{O}-^{14}\text{N}=\text{N}-^{15}\text{N}-\text{O}^-$), with a kinetic isotope effect leading to a preferential cleavage of the $^{14}\text{N}-\text{O}$ bond over the $^{15}\text{N}-\text{O}$ bond (Schmidt et al., 2004a; Toyoda et al., 2002). However, the detailed mechanism is poorly understood, mainly because of the rapid sequential isomerization steps and proton transfer during the reaction of NH_2OH

to the final product N_2O (Fehling and Friedrichs, 2011). Nitroxyl (HNO) has also been discussed as an important initial intermediate (Bonner and Hughes, 1988). In a recent modeling study, Fehling and Friedrichs (2011) found N_2O production to be initialized by formation of HNO, followed by a fast dimerization leading to hyponitrous acid and, after rapid deprotonation, finally to the decomposition of the hyponitrite anion. The fast reaction makes N_2O the only measurable indicator. Our findings suggest that all NH_2OH oxidation processes have a common intermediate in which the N–O bond cleavage is occurring. It also suggests that the SP of N_2O is an indicator of a formation mechanism via a symmetric intermediate but not necessarily of the originating process.

3.4.5. Source partitioning

The $\delta^{15}\text{N}^{\text{bulk}}$ in N_2O emitted from soils is supposed to be determined by the isotopic signature of the substrate, and not by the production process (Sutka et al., 2006). This prevents the use of $\delta^{15}\text{N}^{\text{bulk}}$ alone in N_2O source partitioning, as different processes in soils can feed on the same substrate pools. Our study demonstrated that $\delta^{15}\text{N}^{\text{bulk}}$ was only of very limited use for identifying the N substrate of N_2O production, even though it was a laboratory study under controlled conditions. In field studies, where the isotopic signature of the substrate is often unknown and different intermediate N transformation steps affect the final isotopic signature of emitted N_2O , it will become impossible to disentangle different N_2O production pathways using only $\delta^{15}\text{N}^{\text{bulk}}$. Our results also showed that the $\Delta\delta^{15}\text{N}$ was not constant for the different abiotic reactions studied and was influenced by reaction conditions and perhaps other unknown factors.

The ^{18}O signature of N_2O has been increasingly used to characterize its production processes in soils (Wrage et al., 2005). However, it has been shown that up to 100% of the O in N_2O can originate from H_2O via O exchange mainly between H_2O and NO_2^- , but potentially also between other intermediates of the diverse N transformation and N_2O production pathways (Kool et al., 2009a; Kool et al., 2009b). This entails that the $\delta^{18}\text{O}$ in N_2O reflects the isotopic signature of the substrate O only partially or not at all. With our first continuous measurement of $\delta^{18}\text{O}$ in N_2O , we could confirm the great variability of $\delta^{18}\text{O}$ for abiotic N_2O production. A positive correlation between $\delta^{18}\text{O}$ and SP, as found by Frame and Casciotti (2010) for N_2O production via NH_2OH oxidation, could not be confirmed by our experiments. However, we found a strongly positive correlation between $\delta^{18}\text{O}$ and $\delta^{15}\text{N}^{\text{bulk}}$ of N_2O for experiments with a ^{15}N -depletion over time, and a strongly negative correlation for experiments with an inverse ^{15}N fractionation ($\alpha < 0.05$). Thus, the O exchange during N_2O production in the terrestrial N cycle poses a great challenge for the interpretation of O isotopes in N_2O and their application to biogeochemical studies (Kool et al., 2009b).

Lately, the N_2O SP has been given the greatest potential in overcoming the influence of substrate, variable fractionation and O exchange on isotopic signatures of N_2O . The SP is independent of the

isotopic signature of the substrate and does not change significantly during production (Ostrom and Ostrom, 2011). Thus, the SP provides a conservative tracer of the N_2O production process (Opdyke et al., 2009; Toyoda et al., 2005). The constant SP for the abiotic reactions observed in our study were in the same range as reported for microbial NH_2OH oxidation, fungal denitrification, and AOA (Santoro et al., 2011; Sutka et al., 2008). In contrast, N_2O derived from heterotrophic and nitrifier denitrification can be clearly distinguished from other sources. All other known N_2O production processes are characterized by similar SP. Our results rather demonstrated that the SP does not necessarily reflect the production process per se, but the crucial intermediate which undergoes N–O bond cleavage.

Other pathways like DNRA and anammox can add to soil N_2O production. DNRA can produce N_2O as a side product (Stevens et al., 1998), whereas anammox is thought to bypass the potential N_2O production in aquatic systems (Yang et al., 2012). However, NH_2OH as a possible intermediate of anammox might lead to the formation of small amounts of N_2O (van der Star et al., 2008). It can be assumed that N_2O produced via these pathways has a similarly high SP as N_2O from the other pathways with NH_2OH as the essential intermediate.

3.5. Conclusions

In the present study we could show that the application of quantum cascade laser absorption spectroscopy for monitoring single reactions is a promising and adequate tool for getting deeper insight in the N cycle, as biogeochemical reactions and characteristics like inverse fractionation can be followed in real time. The ^{15}N SP of N_2O from purely abiotic reactions involving the highly reactive nitrification intermediate NH_2OH has been determined for the first time with both high precision and high temporal resolution for different abiotic reaction mechanisms over a wide pH range. Although three different reaction pathways from NH_2OH to N_2O over a wide range of pH values were tested, the SP remained constant within the experimental uncertainty in all reactions, with average SP values ranging only from 33.9 to 35.6‰. Thus, no evidence for an effect of different experimental conditions like pH or buffer medium on SP was found.

This laboratory study puts emphasis on coupled biotic–abiotic reactions in soils and adds a new perspective to N_2O production during nitrification. In most of the reactions studied, conversion of NH_2OH to N_2O was fast as expected due to the very high reactivity of NH_2OH . This implies that NH_2OH could also be quickly converted to N_2O upon release to the soil matrix by ammonium-oxidizing organisms. In addition, this study provides new information, which might be helpful for the source partitioning of N_2O emissions from soils. The SP of N_2O is deemed to have the potential to be a powerful tool in disentangling the different N_2O production and consumption processes in

soils, but in the present study we also showed its limitations. It seems that SP can only be used to differentiate between oxidative and reductive N₂O production, as obviously all processes relevant for N₂O formation during nitrification lead to the same SP. It can be argued that (1) microbial and abiotic processes share the same underlying intermediate steps leading to the same SP, or (2) the observed N₂O formation during nitrification is not of microbial origin but a purely chemical reaction of the nitrification intermediate NH₂OH.

Chapter 4

Abiotic N₂O production from hydroxylamine in soils and their dependence on soil properties

Based on:

Heil, J., Liu, S., Vereecken, H. and Brüggemann, N. (2015) Abiotic nitrous oxide production from hydroxylamine in soils and their dependence on soil properties. *Soil Biol. Biochem.* **84**, 107-115.

4.1. Introduction

N₂O is an important greenhouse gas. It has an about 300 times higher global warming potential than CO₂ over a time frame of 100 years and contributes approximately 6% to anthropogenic radiative forcing, making it the third-most important contributor after CO₂ and methane (WMO, 2013). Furthermore, N₂O is known to be partly responsible for the catalytic destruction of ozone in the stratosphere (Crutzen, 1970). While other historically dominant ozone depleting substances have been successfully regulated by the Montreal Protocol, N₂O is still unregulated and, if present trends continue, will become the dominant ozone depleting substance in the 21st century (Ravishankara et al., 2009). The atmospheric mixing ratio of N₂O has increased by 20% from a pre-industrial level of 270 ppb to 325 ppb in 2012 at a rate of 0.80 ppb yr⁻¹ over the last decade (WMO, 2013). The increase in atmospheric N₂O is tightly coupled to increasing anthropogenic N fixation, mainly applied as fertilizer and manure on agricultural fields.

Soils have been identified as the major source of N₂O, contributing an estimated 50–60% to global N₂O emissions (USEPA, 2010). However, there is still a large uncertainty associated with estimates of global N₂O emissions from natural and anthropogenic sources, ranging from 8.1 to 30.7 Tg N yr⁻¹ (Ciais et al., 2013). This great range of estimated values is mainly a reflection of the great uncertainty of the individual source and sink strengths of the diverse processes involved in N₂O formation and consumption in soils (Billings, 2008).

Two microbial N transformation processes, autotrophic nitrification and heterotrophic denitrification, are considered the major N₂O sources, contributing an estimated 70% of the global N₂O emissions from soils (Butterbach-Bahl et al., 2013). However, as discussed in great detail above, there is a lot of uncertainty about the sole production of N₂O by microbial processes, as several abiotic production mechanisms involving the nitrification intermediate NH₂OH have been shown to be feasible in soils.

Lately, stable isotope techniques have developed great potential for disentangling the variety of different N₂O formation processes; especially the intramolecular distribution of ¹⁵N in N₂O, the so-called site preference (SP), has been in the focus of recent research (Decock and Six, 2013). The site-specific isotopic signature of N₂O produced by several microbial pathways has been studied (Frame and Casciotti, 2010; Opdyke et al., 2009; Sutka et al., 2008; Sutka et al., 2006; Well et al., 2006; Wunderlin et al., 2013) as well as for abiotic N₂O production via NH₂OH oxidation (Heil et al., 2014). However, until now it is impossible to unambiguously differentiate between N₂O production and consumption processes using SP information (Ostrom and Ostrom, 2011).

For better N₂O mitigation strategies it is vital to understand the multitude of underlying microbial and abiotic processes of N₂O production in the terrestrial N cycle and their controlling factors, as it is likely that N₂O emissions from soils will increase at an ever growing rate due to an increasing

demand for food, accompanied by an increased use of N fertilizer (Ciais et al., 2013). A better understanding is also prerequisite for lowering the high model uncertainty related to N₂O emissions that is caused by the multitude of simultaneous processes involved in N₂O formation, but also by the high temporal and spatial variability of these processes.

The chemical oxidation of NH₂OH in the presence of several transition metals commonly found in soils was recognized more than 30 years ago (Bremner et al., 1980), but is still neglected in most current N trace gas studies. The present study was designed to test for the potential of a coupled biotic–abiotic mechanism of N₂O production under aerobic conditions, in which NH₂OH microbially produced during nitrification is leaking to a certain extent out of autotrophic and heterotrophic nitrifiers into the soil matrix, where it is readily oxidized to N₂O by transition metals, such as manganese or iron, or by NO₂[−], which is also excreted by ammonium-oxidizers. To test for this potential mechanism, we added NH₂OH to soil samples from different ecosystems (forest, grassland, cropland), both under non-sterile conditions and after sterilization with three different sterilization methods. The guiding hypothesis of the study was that at least in some soils this coupled biotic–abiotic mechanism might play a significant role in aerobic N₂O formation during nitrification.

4.2. Material and methods

4.2.1. Sample collection

Soil samples were collected from three field sites (cropland, grassland, coniferous forest) that are part of the TERENO network, and additionally from a deciduous forest on the campus of Forschungszentrum Jülich (50°54'38"N, 6°24'44"E). The coniferous forest site (Wüstebach; 50°30'15"N, 6°18'15"E) was situated in the low mountain ranges of the Eifel National Park. The main vegetation at this site is Norway spruce (*Picea abies* (L.) Karst.). The soil type was a Cambisol with a loamy silt texture. The grassland site (Rollesbroich; 50°37'18"N, 6°18'15"E) was located in the Northern Eifel region. The soil type was also Cambisol. The agricultural site (Selhausen; 50°52'09"N, 6°27'01"E) was intensively used with regular lime and fertilizer applications. The soil type was classified as a Luvisol with a silty loam texture. At each site, soil samples were collected from the top 20 cm. At the coniferous forest site, the top 20 cm were divided into litter layer (L), organic topsoil horizon (Oh), and humic mineral topsoil layer (Ah) and collected separately. After collection, samples were transferred to the institute, where they were sieved to 2 mm and stored at 4 °C under well aerated conditions for further analysis.

4.2.2. Soil chemical analyses

Soil samples were analyzed for chemical parameters by the central analytical laboratory of Forschungszentrum Jülich. The total C and total N content were determined using an elemental analyzer (vario EL Cube, Elementar Analysensysteme, Hanau, Germany). For measurements, 20–50 mg sample material, in replicates of three, were analyzed. Concentrations of a range of elements were determined by ICP-OES. Sample extraction was done using lithium borate by extracting the mixture at 1000 °C for 30 min in a muffle furnace. The melt was dissolved in 30 mL HCl (5%) and filled up to a volume of 50 mL before analysis for total Ca, Cu, Fe, K, Mg, Mn, Na, and Sn content. Soil pH was determined in 0.01 M CaCl₂ solution. An overview of all soil chemical parameters determined can be found in Table 4.1.

4.2.3. Incubation experiments

To study the formation of N₂O in the different soils in dependence of NH₂OH content, incubation experiments were conducted in the laboratory. One gram (dry weight) of soil (0.5 g for litter) were weighed into 22-mL GC headspace vials (VWR International, Darmstadt, Germany), and the water content of the soil samples was adjusted to 50% water holding capacity (WHC) with deionized water or NH₂OH solution, respectively. Vials were closed gastight immediately afterwards with butyl septa and aluminum crimp caps (VWR International). Each treatment was carried out in replicates of three. The standard application rate of NH₂OH was 5 nmol (5 nmol per g soil), but experiments with a higher application rate of 10 nmol (10 nmol per g soil) were also conducted. Incubation experiments were performed with non-sterile as well as sterile soils. We used three different methods of sterilization: autoclaving, chloroform fumigation, and methyl iodide fumigation. Through autoclaving, samples were sterilized by exposing them to a temperature of 121°C and a pressure of 0.3 MPa for 30 min. For sterilization with chloroform fumigation, soil samples were placed into an 18.5 L desiccator together with 100 mL of chloroform (Merck, Darmstadt, Germany) in a separate beaker. The desiccator was closed and evacuated, and the soil samples were exposed to chloroform at room temperature for 24 h. Methyl iodide fumigation was conducted in an analogous manner, only exchanging chloroform with 5 mL methyl iodide (99% reagent plus grade, Sigma-Aldrich, Steinheim, Germany) as described in Oswald et al. (2013). Incubations were performed at the same day sterilization procedures were finished.

Site	pH	C	N	C/N	Ca	K	Mg	Na	Fe	Mn
	[-]	[mass-%]	[mass-%]	[-]	[mass-%]	[mass-%]	[mass-%]	[mass-%]	[mass-%]	[mass-%]
<i>coniferous forest</i>										
Litter	3.4	45.70	2.02	22.60	0.29	0.21	0.09	0.03	0.52	0.02
Oh	2.9	29.30	1.43	20.50	0.11	0.73	0.13	0.10	2.05	0.00
Ah	3.1	14.10	0.72	19.50	0.05	1.15	0.17	0.15	3.34	0.00
<i>deciduous forest</i>										
deciduous forest	3.6	12.60	0.63	19.90	0.27	1.00	0.16	0.43	1.23	0.08
grassland	4.9	2.88	0.27	10.50	0.19	1.63	0.28	0.32	2.90	0.11
cropland	6.4	1.09	0.11	9.60	0.37	1.46	0.33	0.57	2.25	0.09

Table 4.1: Overview of the different soil samples and their chemical parameters that were used in this study.

Experiments were conducted with field moist as well as with pre-dried samples. The pre-dried samples were dried slowly at 60 °C until the weight was constant. The incubation time in all experiments was 6 h at room temperature (20 °C). At the end of the incubation time, the headspace of the sample vials was analyzed using a gas chromatograph (Clarus 580, PerkinElmer, Rodgau, Germany) equipped with an electron capture detector (ECD) for N₂O detection. The instrument was calibrated using three different standard gases with 250, 500, and 750 ppb N₂O balanced with N₂ (99.5% purity, Linde, Munich, Germany).

4.2.4. Reaction kinetics analyses

Experiments to determine the reaction kinetics of NH₂OH oxidation to N₂O were conducted for the different soils with a flow through-reaction chamber connected to an infrared laser absorption spectrometer for online real-time analysis of N₂O mixing ratio (Dual Laser Quantum Cascade Trace Gas Monitor, Aerodyne Research, Inc., Billerica, MA, USA). The instrument consists of two mid-infrared lasers and is able to measure N₂O, CO₂, CH₄, H₂O simultaneously at a temporal resolution of up to 10 Hz. Water vapor is measured to correct for volumetric dilution and pressure broadening effects caused by increasing water vapor concentration in the sample air. Prior to every experiment the cell was flushed with synthetic air and a new background spectrum was taken. The instrumental precision of the measurements given as standard deviation of the average N₂O mixing ratio at atmospheric level was <0.3 ppb.

The first experiment was carried out with non-sterile as well as autoclaved and chloroform-fumigated soil samples. For this purpose, 10 g of soil (dry weight) were weighed into a 250-mL beaker, so that the bottom of the beaker was completely covered. The soil water content was adjusted to 50% WHC with NH₂OH solution. Depending on the initial moisture level of the soil samples, different amounts of solution had to be added, but NH₂OH concentration of the solutions was individually adapted, so that the same amount of 5 μmol NH₂OH (500 nmol per g soil) was added to each sample. A hundredfold higher amount of NH₂OH per g soil compared to the incubation experiments had to be chosen for sufficiently high N₂O formation to achieve a high measurement precision at the high air flow rate through the incubation chamber. Immediately after addition of the solution to the soil sample, the beaker was placed in the flow-through chamber, which was instantly closed. The chambers were custom-made of a quartz glass cylinders fitted with PTFE cover plates. The PTFE plates were hold together by seven aluminum rods at the outside of the chamber. The contact surfaces were sealed with Viton® O-rings. A fan inside the chamber assured uniform mixing of the gas phase. The chamber volume was 2 L and it was purged with 2.5 L min⁻¹ of pressurized air controlled by a mass flow controller (Brooks Instruments, Dresden, Germany) during the experiment. The outlet of the chamber was directly connected to the laser analyzer via PTFE tubing.

A second experiment was conducted to quantify N₂O formation from NH₂OH in soil at different temperatures. A refrigerating and heating water circulator (RC 20 CS, LAUDA, Lauda-Königshofen, Germany) was used to maintain constant temperatures. In this experiment, 25 g of autoclaved cropland soil (dry weight) were transferred to an autoclaved 500-mL bottle (SCHOTT DURAN®, DURAN Group GmbH, Wertheim, Germany). The bottle was then placed in the water bath, so that only the bottleneck was above the water surface. To monitor soil temperature, a mercury thermometer was pushed into the soil that had been sterilized with ethanol immediately before use. Then, like in the first experiment, NH₂OH solution was added to adjust soil water content to 50% WHC, corresponding to a NH₂OH amount of 5 μmol (200 nmol per g soil). The bottle was closed gastight with custom-made lids with gas inlet and outlet ports immediately afterwards and flushed with 2.5 L min⁻¹ pressurized air as described above.

4.2.5. N₂O isotopic analyses

For the determination of N₂O isotopic composition and ¹⁵N isotopomer signatures, 5 g of soil (2.5 g for litter) were weighed into 100 mL headspace vials (VWR International) and treated the same way as samples for GC incubation experiments. According to the five times larger headspace in the IRMS vials, we used five times more sample material and added a five times higher amount of NH₂OH to the soil (25 nmol; 5 nmol per g soil). Samples were incubated under the same conditions as for the GC incubation. After 6 h incubation time, the headspace of the vials was analyzed using an isotope ratio mass spectrometer (IRMS) (IsoPrime 100, Elementar Analysensysteme, Hanau, Germany) coupled to a pre-concentration unit (TraceGas, Elementar Analysensysteme) for online separation and purification of N₂O.

With the IRMS, the mass-to-charge ratios (*m/z*) 44, 45, and 46 of the N₂O⁺ ion and *m/z* 30 and 31 of the NO⁺ fragment ion of N₂O were measured and used to determine the isotopologue and isotopomer signatures of N₂O (Toyoda and Yoshida, 1999). More specifically, δ¹⁵N^{bulk} (i.e., the average δ¹⁵N over the N₂O molecule), δ¹⁵N^α (i.e., δ¹⁵N at the central position of the N₂O molecule), and δ¹⁸O of N₂O were determined. The δ¹⁵N at the terminal position of the N₂O molecule, δ¹⁵N^β, was calculated according to δ¹⁵N^β = 2 · δ¹⁵N^{bulk} - δ¹⁵N^α. The ¹⁵N SP is then defined as SP = δ¹⁵N^α - δ¹⁵N^β. A correction for ¹⁷O was performed, assuming a mass-dependent fractionation of ¹⁷O and ¹⁸O and using the calculations according to Kaiser et al. (2003), with ¹⁷R = 0.00937035 · (¹⁸R)^{0.516}. We used pure N₂O (99.999%, Linde, Munich, Germany) as working standard for isotope analysis, and δ¹⁵N^{bulk}, δ¹⁸O, and SP were calibrated against two reference gases (Ref 1: δ¹⁵N^α: 15.70 ± 0.31‰, δ¹⁵N^β: -3.21 ± 0.37‰, δ¹⁵N^{bulk}: 6.24 ± 0.11‰, SP: 18.92 ± 0.66‰, δ¹⁸O: 35.16 ± 0.35‰; Ref 2: δ¹⁵N^α: 5.55 ± 0.21‰, δ¹⁵N^β: -12.87 ± 0.32‰, δ¹⁵N^{bulk}: -3.66 ± 0.13‰, SP: 18.42 ± 0.50‰, δ¹⁸O: 32.73 ± 0.21‰) provided by EMPA (Dübendorf, Switzerland) and as described in Mohn et

al. (2014). Analytical precision, expressed as standard deviation, was 0.1‰, 0.2‰, and 0.2‰ for $\delta^{15}\text{N}$, $\delta^{18}\text{O}$, and SP, respectively.

Isotope values are reported in the delta notation, with $\delta = (R_{\text{sample}}/R_{\text{standard}} - 1) \times 1000$, where R_{sample} and R_{standard} are the ratio of heavy to light isotope ($^{15}\text{N}/^{14}\text{N}$ or $^{18}\text{O}/^{16}\text{O}$) in the sample and an international standard, i.e., atmospheric N₂ for nitrogen and Vienna Standard Mean Ocean Water (VSMOW) for oxygen, respectively.

4.2.6. Calculations

N₂O emission rates following NH₂OH addition were calculated by subtracting N₂O emission rates from corresponding control samples. The mass of N₂O-N produced was calculated using the ideal gas law at standard laboratory conditions ($p = 1013 \text{ mbar}$; $T = 293.15 \text{ K}$).

To interpret isotopic data of N₂O following NH₂OH addition, a simple two-source mixing model was used. From the mass-weighted δ -value of the sample (N₂O with NH₂OH addition), the mass-weighted δ -value of the background (N₂O with H₂O addition only) was subtracted and divided by the sum of the two masses: $\delta_{\text{sample}} = (\delta_{\text{NH}_2\text{OH}} m_{\text{NH}_2\text{OH}} - \delta_{\text{H}_2\text{O}} m_{\text{H}_2\text{O}}) / (m_{\text{NH}_2\text{OH}} + m_{\text{H}_2\text{O}})$.

All statistical analyses were performed using OriginPro 8 (OriginLab Corp., Northampton, MA, USA). An unpaired t-test was used to test for treatment differences at a significance level $\alpha < 0.05$. The uncertainty of the provided data is given as the standard deviation of the replicates. For calculated values, uncertainties of all individual measured parameters propagate to the error of the derived value on the basis of the standard deviation.

4.3. Results

4.3.1. Soil incubation experiments

While neither the L nor the Oh horizon of the spruce forest soil showed significantly higher N₂O evolution upon the addition of NH₂OH compared to the H₂O only treatment, the Ah horizon exhibited N₂O formation only after NH₂OH addition, while in the H₂O treatment there was no N₂O formed at all (Fig. 4.1.). In contrast, N₂O formation in the deciduous forest soil could be observed for both treatments, but significantly more with NH₂OH than with H₂O only. The strongest reaction to NH₂OH addition was found in the grassland and cropland soils, whereas there was no N₂O formation after H₂O addition. The turnover of NH₂OH-N to N₂O-N during the incubation time of 6 h was 44% for the grassland, and 56% for the cropland soil.

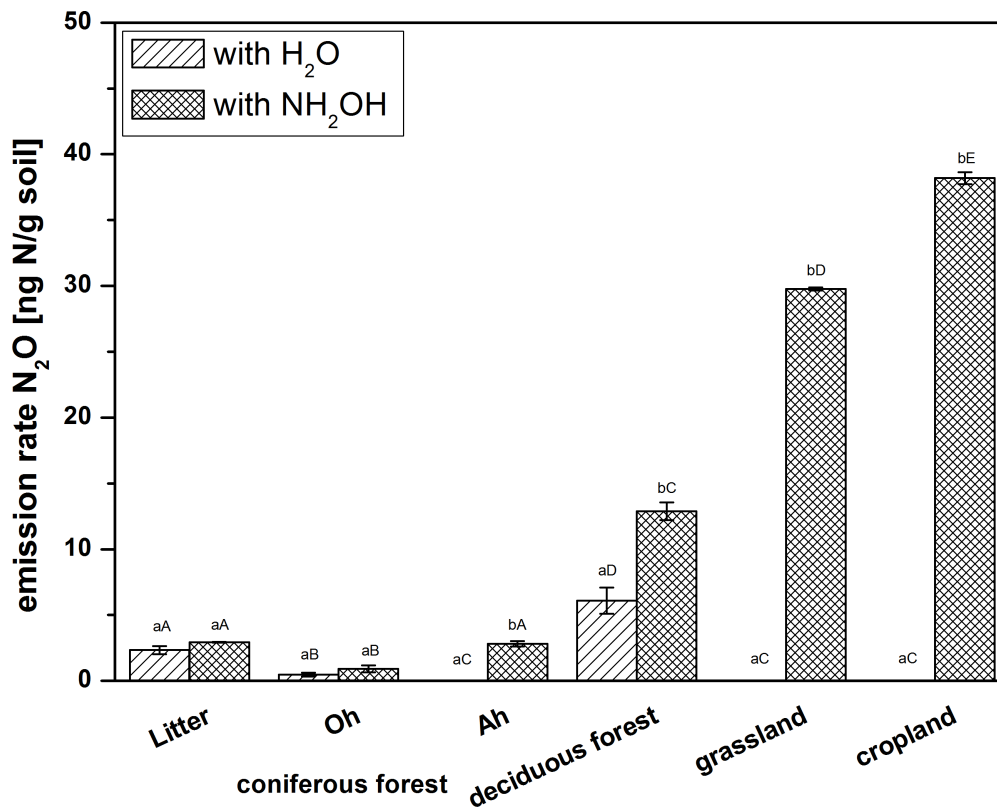

Figure 4.1: N_2O emission rates in ng N per g soil from six different non-sterile soil samples after the addition of deionized H_2O or NH_2OH solution (5 nmol) in 6-h incubation experiments. Samples of ambient air were measured and subtracted as backgrounds from the results. Error bars represent the SD of three replicates. Lower case letters indicate significant differences between different treatments at one site, capital letters between the different sites within one treatment ($\alpha < 0.05$).

In a second series of incubations under the same conditions we used different sterilization methods to test the hypothesis of an abiotic production mechanism. N_2O formation after NH_2OH addition differed between sterile and non-sterile soil samples, and in addition also between sterilization methods (Fig. 4.2). Autoclaving had the strongest effect on NH_2OH -induced N_2O emissions in all samples. In the coniferous forest soil samples it reduced N_2O emission rates to zero in all three soil horizons. Also in the grassland soil a strong attenuation effect was observed, with N_2O emission rates after NH_2OH addition being reduced by almost 99%. The only soil showing significant N_2O emissions upon NH_2OH addition after autoclaving was the cropland soil, for which the amount of N_2O formed was only reduced by approx. 50%. Chloroform fumigation did not have such a pronounced effect on N_2O emission rates as autoclaving. It did not have a significant effect in the L and Oh horizon of the coniferous forest soil, led to a decrease of about 20% in both the grassland and cropland soil, and lowered N_2O formation by about 50% both in the Ah layer of the coniferous forest and in the deciduous forest soil. The third sterilization method, the fumigation of samples with methyl iodide, led to similar results as chloroform fumigation (Fig. 4.2).

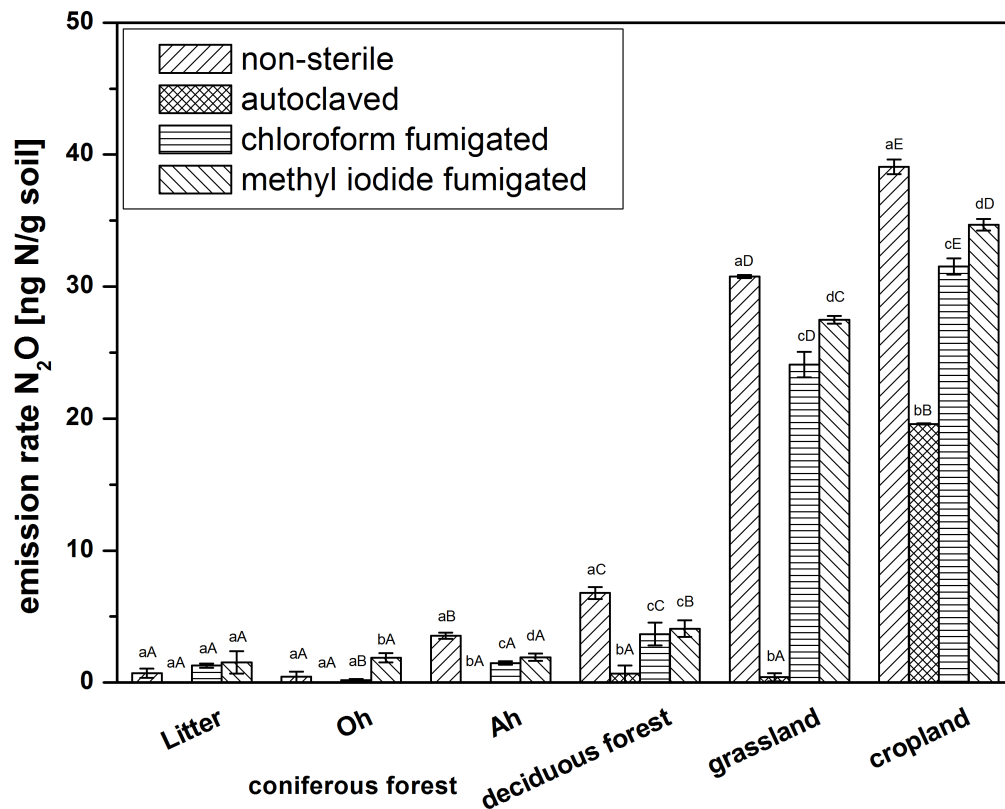

Figure 4.2: N₂O emission rates in ng N per g soil from six different non-sterile and sterilized soil samples after the addition of NH₂OH solution (5 nmol) in 6-h incubation experiments. Replicates with the addition of deionized H₂O were used as backgrounds and subtracted from the results. Error bars represent the SD of three replicates. Lower case letters indicate significant differences between different treatments at one site, capital letters between different sites within one treatment ($\alpha < 0.05$).

Drying of the soil prior to the incubation led to lower NH₂OH-induced N₂O emission rates (Fig. 4.3). The largest decrease could be observed for the grassland and deciduous forest site, while for the cropland soil it was only marginal compared to fresh soil. However, also the reduction of N₂O emission rates by autoclaving was lower when soil samples were dried before incubation. Both non-sterile and sterile cropland soil samples had NH₂OH-to-N₂O turnover rates higher than 50%. A two-fold increase in NH₂OH addition (10 nmol) led to an increase in N₂O emission rates in all soils (Fig. 4.3). The three coniferous forest soil horizons showed a slight increase after adding twice the amount of NH₂OH, but still remained at a very low level. The other three non-sterile soils reacted to doubling of added NH₂OH amount with an increase in N₂O emission rates by factors of 2.4, 2.1, and 2.9, respectively. In sterilized cropland samples about 49% of the added 10 nmol NH₂OH-N had been converted to N₂O-N. This was again by far the highest value of all soils of this study (Fig. 4.3).

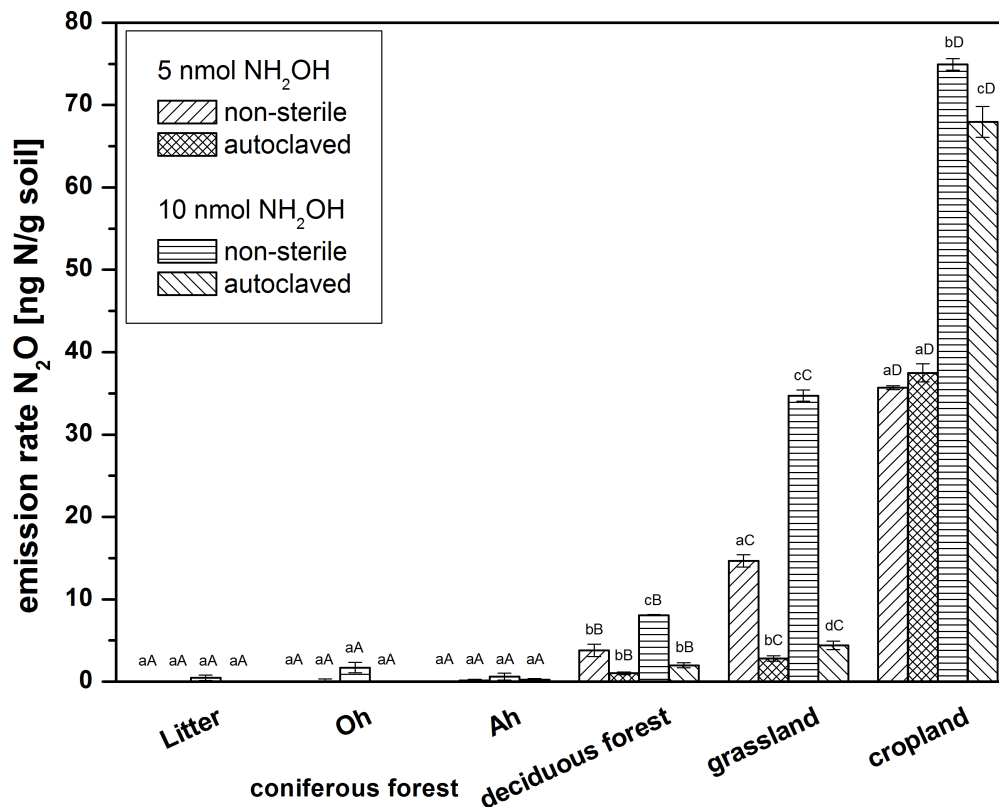

Figure 4.3: N_2O emission rates in ng N per g soil from six different non-sterile and sterilized soil samples after the addition of two different amounts of NH_2OH (5 and 10 nmol) in 6-h incubation experiments. Replicates with the addition of deionized H_2O were used as backgrounds and subtracted from the results. Error bars represent the SD of three replicates. Lower case letters indicate significant differences between different treatments at one site, capital letters between the different sites within one treatment ($\alpha < 0.05$).

4.3.2. Kinetics of N_2O formation

Infrared laser absorption measurements at a temporal resolution of 1 Hz provided insight into the kinetics of the oxidation of NH_2OH in the different soils of this study. The course of the reaction was very similar for all soils: N_2O formation peaked only seconds after the addition of NH_2OH , followed by a rapid decline (Fig. 4.4). Already 30 min after NH_2OH addition N_2O mixing ratios were back to baseline levels in most samples. However, the amplitude of the N_2O peaks was significantly different between different soil samples. The differences in peak heights were similar to the differences in N_2O formation in the GC incubation experiments. Highest N_2O production was found in the non-sterile cropland soil, where chloroform fumigation decreased N_2O formation only slightly, while autoclaving reduced the N_2O by more than half (Fig. 4.4 A). In all soil samples and treatments, N_2O emissions dropped quickly, and most of the reaction was completed in less than 5 min. At this point in time, already 48.5% of the NH_2OH-N added to the non-sterile cropland soil had been converted to N_2O-N . This rate reached 57.1% after 15 min and 58.5% after 30 min. In contrast, autoclaving reduced the turnover rate to 31.5%.

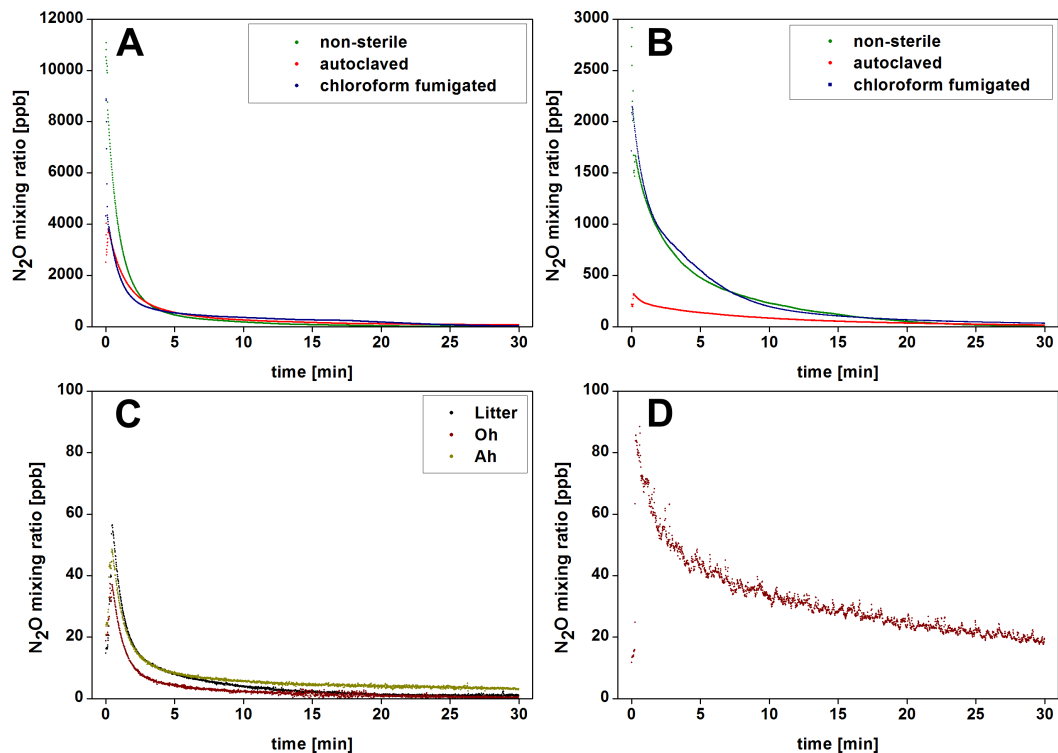

Figure 4.4: N_2O mixing ratios in ppb measured at a temporal resolution of 1 Hz emitted from different soils after the addition of NH_2OH solution ($5 \mu mol$): (A) from non-sterile and sterile cropland soil, (B) from non-sterile and sterile grassland soil, (C) from the three non-sterile coniferous forest soil layers, and (D) non-sterile deciduous forest soil.

The addition of the same amount of NH_2OH to the grassland soil led to a maximum peak of N_2O that was three times lower than for the cropland soil (Fig. 4.4 B). The total N turnover from NH_2OH to N_2O after 30 min was also lower (31.9%), owing to the lower reaction velocity, which was also reflected in a longer tailing of N_2O mixing ratio. No significant difference was observed between non-sterile and chloroform-fumigated soil samples, whereas autoclaving reduced N_2O formation significantly, with only 9.3% of the added NH_2OH-N converted to N_2O-N .

The different layers of the coniferous forest soil showed a NH_2OH -induced N_2O emission that was two orders of magnitude lower than in the cropland soil, with a small N_2O peak within the first 5 min of the experiment (Fig. 4.4 C). A similar, only slightly higher, N_2O formation was observed for the deciduous forest soil (Fig. 4.4 D), but the reaction progress was clearly different compared to the coniferous soil, with a slower decrease and longer tailing of N_2O mixing ratio.

To ultimately test whether N_2O formation from NH_2OH occurred via chemical and not a biological reaction, a last experiment was conducted with the laser spectrometer to study the effect of different temperatures on NH_2OH oxidation in soils. For this experiment we chose autoclaved, sterile cropland soil only. The experiment revealed that increasing temperature from $10 \text{ }^\circ C$ to $50 \text{ }^\circ C$ was associated with a steady increase in the initial N_2O peak height and faster reaction kinetics, i.e., a faster decline of N_2O mixing ratios back to the background level (Fig. 4.5). However, despite dif-

ferent kinetics there was no significant differences in turnover of added NH_2OH-N to N_2O-N between the different temperatures from the cropland soil, which amounted to about 25% at all temperature levels after one hour. Furthermore, the findings demonstrated that the oxidation of NH_2OH proceeded extremely fast and that no further oxidation of the added NH_2OH to N_2O could be observed after less than one hour.

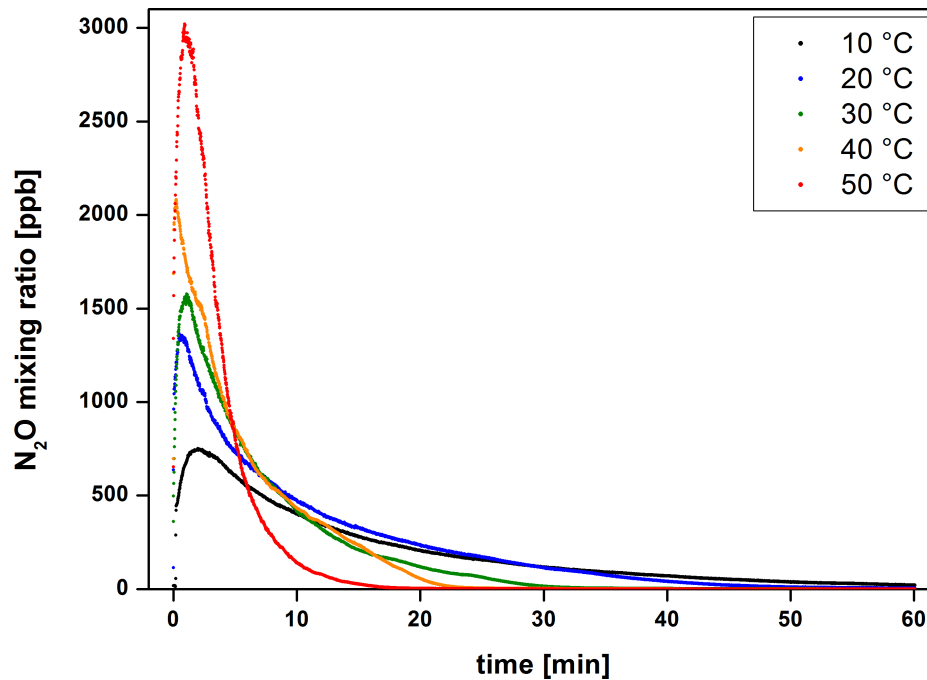

Figure 4.5: N_2O mixing ratios in ppb measured at a temporal resolution of 1 Hz emitted from sterile (autoclaved) cropland soil after the addition of NH_2OH solution ($5 \mu mol$) at different temperatures from 10 to 50 °C.

4.3.3. Isotopic signature of produced N_2O

The isotopic signature of N_2O emissions from the L and Oh horizon of the coniferous forest site could not be determined because N_2O production was too low. The $\delta^{15}N^{bulk}$ values of N_2O from Ah horizon of the coniferous soil as well as of the grassland and cropland soils were in the range of -5 to -8% , i.e., ^{15}N -depleted compared to the NH_2OH substrate, which had a $\delta^{15}N$ of $-1.93 \pm 0.11\%$ (Table 4.2). In contrast, $\delta^{15}N^{bulk}$ of N_2O from the deciduous forest soil was slightly ^{15}N -enriched over the $\delta^{15}N$ of NH_2OH , but this value was also associated with a much higher uncertainty due to the low amount of N_2O formed. The $\delta^{18}O$ values spread out over a larger range than ^{15}N values, did not reveal a clear pattern, and showed a much higher variability among replicates than $\delta^{15}N$ values. The ^{15}N SP for the three soils with highest amount of N_2O formed, i.e., grassland, non-sterile and autoclaved cropland was on average 35%. The SP values of the other two soils were 2–3% lower, but also afflicted with a much higher uncertainty, which was negatively correlated with the amount of N_2O produced.

Table 4.2: Turnover rate of added NH₂OH-N to N₂O-N, isotopic signatures and ¹⁵N site preference (SP) of N₂O emitted after addition of NH₂OH to several soils.

Site	Turnover rate	$\delta^{15}\text{N}^{\text{bulk}}$	$\delta^{18}\text{O}$	SP
	[%]	[‰ vs. air N ₂]	[‰ vs. VSMOW]	[‰]
coniferous forest (Ah)	2.0 ± 0.2	-8.09 ± 1.53	35.95 ± 9.25	33.02 ± 4.63
deciduous forest	3.5 ± 0.9	0.47 ± 5.68	47.20 ± 18.05	31.81 ± 14.93
grassland	36.9 ± 2.4	-6.10 ± 0.73	43.57 ± 4.86	35.21 ± 1.94
cropland (non-sterile)	45.8 ± 1.5	-5.12 ± 0.50	45.74 ± 3.03	35.66 ± 1.56
cropland (autoclaved)	43.7 ± 3.6	-7.02 ± 0.70	42.63 ± 4.76	34.12 ± 1.85

4.4. Discussion

4.4.1. Abiotic N₂O formation from different soils

There has been some controversy in the past about exclusively microbial formation of N₂O during nitrification (Arp and Stein, 2003; Beaumont et al., 2002; Schmidt et al., 2004b; Yu et al., 2010). However, most studies relate N₂O production during nitrification to microbial pathways. Positive correlations between high ammonia oxidation activity and N₂O production in chemostat and mixed culture experiments have been found (Wunderlin et al., 2012; Yu et al., 2010). Although it is believed that the ammonia oxidation intermediate NH₂OH is generally not released in the environment, NH₂OH release by AOB had been reported by Stüven et al. (1992) and Schmidt et al. (2004b). Nevertheless, a large part of the soil NH₄⁺ pool will pass through NH₂OH during nitrification (Arp and Stein, 2003), and a release of NH₂OH could be followed by a fast chemical oxidation of NH₂OH leading to a non-detection. The possibility of such a mechanism has been recently emphasized by results obtained from a newly developed highly sensitive method for determination of soil NH₂OH, which revealed a positive correlation between NH₂OH and N₂O (Liu et al., 2014).

Our assumption of a possible abiotic N₂O production at aerobic conditions via oxidation of the nitrification intermediate NH₂OH could be partially verified. We demonstrated that for the agricultural and grassland soils of our study the oxidation of NH₂OH could be a potential pathway of N₂O formation, while for forest soils this mechanism seems to be of no or only minor importance. This is supported by the observation that chloroform fumigation did not lead to a complete reduction of N₂O formation from NH₂OH, and in most treatments the reduction was only small compared to non-sterile samples. As chloroform fumigation is the standard method for determining total soil microbial biomass (Jenkinson and Powlson, 1976), which requires complete lysis of microorgan-

isms, one should assume that – despite controversy whether this method is indeed completely accounting for all microorganisms in the soil – the soil should be sterile or that at least microbial activity should be reduced to a minimum. Autoclaving, on the other hand, is one of the standard methods in microbiology and medicine for sterilization. Thus, the fast formation of significant amounts of N₂O in both autoclaved and chloroform-fumigated grassland and cropland soil indicated an abiotic production mechanism. An even stronger proof of an abiotic, i.e., purely chemical oxidation of NH₂OH, was obtained from the incubations at different temperatures (Fig. 4.5). The increasing reaction velocity with increasing temperature, even clearly beyond common microbiological temperature optima, was in accordance with the thermodynamics of a chemical reaction. The reaction also resembled the pseudo-first order kinetics of the oxidation of NH₂OH with manganese dioxide (MnO₂) that we had found in supporting experiments (data not shown). For microbial processes potentially responsible for N₂O formation from NH₂OH added to soil, such as nitrification, a different behavior with temperature would be expected. For example, the ammonium-oxidizing bacterium *Nitrosomonas europaea* has its temperature optimum of growth and activity at around 35 °C (Grunditz and Dalhammar, 2001), and a linear relationship between activity of *N. europaea* and temperature was found between 10 and 30 °C (Groeneweg et al., 1994). Potentially there are thermophilic AOB (Lebedeva et al., 2005) or archaea (De La Torre et al., 2008) still active at elevated temperatures; however, it is unlikely that such populations developed in the short period under the prevailing experimental conditions. Thus, the faster turnover of NH₂OH at 50 °C compared to 40 °C in our sterile agricultural soil clearly demonstrated the potential of this soil to oxidize NH₂OH abiotically to N₂O.

In our study, we found lower N₂O formation in autoclaved soils than in samples fumigated with chloroform and methyl iodide. A possible explanation for this observation is that during autoclaving the soil is exposed to high temperatures and high pressure. These conditions are likely to alter the soil organic matter composition by favoring hydrolysis of organic molecules, thereby enhancing the concentration of dissolved organic matter and increasing the accessibility of reactive functional groups, like carbonyl groups, that can readily react with NH₂OH, e.g., to oximes (Bremner et al., 1980). This increased competition for NH₂OH between dissolved organic matter binding NH₂OH and oxidants converting NH₂OH to N₂O, subsequently could lead to less N₂O formation, as discussed in more detail below. This could also explain, why the cropland soil was least affected by autoclaving because it has the lowest organic C content, while N₂O formation in autoclaved grassland soil, with a much higher organic C content, was almost zero.

The recovery rates of added NH₂OH-N as N₂O-N reached from insignificant in forest to about 50% in cropland soils. This recovery rates were quite stable for individual soils, thus they seemed to be influenced by soil parameters. However, sterilization methods, especially autoclaving, generally led to a reduction of the recovery rates. As autoclaving is quite a harsh sterilization method, it is

likely that it altered soil chemistry. Still, 50% or more of added NH₂OH-N was not detected as N₂O-N. The gaseous products NO or NO₂ can be excluded as possible further products, as no significant amounts of these gases had been observed during our studies (data not shown). It cannot be excluded that N₂ was a product of these incubations; however, we were not able to measure N₂ against the high atmospheric background, and the gas would also be of no environmental concern. A fraction of the added NH₂OH-N was likely bound to organic matter as oxime, and NH₂OH might have been also oxidized to other mineral N forms, such as nitrite, but further research is needed in this respect.

4.4.2. Factors influencing abiotic N₂O formation

To identify control factors of NH₂OH-induced N₂O formation and to explain the differences in NH₂OH oxidation potential between the different soils, we correlated N₂O emission rates from non-sterile as well as sterile soils with soil physical and chemical parameters (Table 4.3). The correlation of soil pH and C/N ratio with N₂O emission rates yielded the highest correlation coefficients of all parameters tested, especially for non-sterile and chloroform-fumigated soils. Correlation coefficients for the same correlation in autoclaved soils were lower. While the correlation between soil pH and N₂O emissions was positive, i.e., more N₂O was formed at higher pH, a negative correlation was observed for the relationship between N₂O emission and C/N ratio. Thus, the lower the C/N ratio the more N₂O was formed from the same amount of NH₂OH. Correlations between N₂O emission and soil C and N alone were also negative, but not significant, clearly indicating that the C/N ratio as an indicator of soil organic matter quality was the better predictor of N₂O emissions via NH₂OH oxidation.

Several soil cations also featured partially significant correlations with emitted N₂O, especially Mg. However, most of these cations were also closely correlated with soil pH (data not shown), so that the relationship between non-oxidative cation, such as Ca and Mg and N₂O emission was likely a cross-correlation. This assumption was supported by additional experiments in aqueous solution, affirming that neither Na and K, nor Mg and Ca were able to convert NH₂OH to N₂O (data not shown). The ability of the two remaining cations, iron and Mn, to oxidize NH₂OH to N₂O has been shown elsewhere (Bremner et al., 1980; Butler and Gordon, 1986). However, in our soils the iron content was only weakly correlated with NH₂OH-related N₂O formation. In contrast, much higher correlation coefficients were found for Mn, albeit just below significance.

Table 4.3: Pearson correlation coefficients of the linear correlation between the N₂O emission rates after the addition of NH₂OH from non-sterile, chloroform-fumigated, and autoclaved soils and several measured soil chemical parameters.

	pH	C	N	C/N	Ca	K	Mg	Na	Fe	Mn
N ₂ O emission rate, non-sterile soil	0.97*	-0.78	-0.79	-0.98*	0.52	0.80	0.97*	0.79	0.36	0.79
N ₂ O emission rate, chloroform-fumigated	0.98*	-0.73	-0.75	-0.98*	0.54	0.76	0.96*	0.76	0.33	0.77
N ₂ O emission rate, autoclaved soil	0.87*	-0.50	-0.53	-0.67	0.66	0.43	0.73	0.74	0.09	0.40

*significant at a 0.05 level

Despite the much lower Mn content compared to the iron content of the soils (Table 4.1), this can be easily explained by the difference in redox potential of the two redox pairs Fe²⁺/Fe³⁺ and Mn²⁺/Mn⁴⁺, which highly favors the reaction of NH₂OH with Mn⁴⁺ over the reaction with Fe³⁺. Thus, it becomes obvious that much less abundant Mn can exert a higher control on NH₂OH oxidation than iron.

On the basis of the results of the correlation analysis, we conclude that there are three soil parameters, of which one or more could explain the abiotic oxidation of NH₂OH in soils: soil pH, C/N ratio, and soil Mn content. However, the correlation analysis is based only on a few data points, and especially for C/N ratio basically only two values are available, so that collinearity could be a problem. Thus, more research on the individual parameters and their influence on abiotic N₂O production is needed to verify this hypothesis. Yet, there is a chemical mechanism explaining the influence of each of the parameters. The strong influence of soil pH on abiotic N₂O formation can be explained chemically, as NH₂OH as the precursor of N₂O has a pK_a of 5.95. Below this pH value NH₂OH also exists in its protonated (NH₃OH⁺), which is more stable than free NH₂OH. With decreasing pH, the ratio between protonated and unprotonated form increases, thus, at a lower pH more NH₃OH⁺ is present and less free NH₂OH is available for oxidation. The effect of C/N ratio on N₂O emission rates can be explained by a competitive reaction of NH₂OH with organic C that is higher at higher soil carbon content and even more so at wider C/N ratios. Soil organic C contains carbonyl groups, and at wider C/N ratios there are potentially more of these groups available. It was shown that NH₂OH can react with carbonyl groups to form oximes (R¹R²-C=N-OH) (Porter, 1969), and Bremner et al. (1980) found a highly significant correlation between oxime N and organic C after the addition of NH₂OH to sterile soils. These initial oximes can further undergo Beckmann rearrangements and form secondary organic soil constituents (Thorn and Mikita, 2000). These findings are in accordance with our results of lower N₂O formation with higher organic C content and also support our assumption of a strong influence of C/N ratio on abiotic N₂O formation. The third important soil parameter identified was soil Mn content, although the correlation coefficient is just below significance. It is known that several transition metals can oxidize NH₂OH to N₂O (Butler and Gordon, 1986). Especially Fe³⁺ had been in the focus of research, as it is ubiquitously present in almost every soil. However, Fe³⁺ ions are frequently bound in insoluble form and thus, are not readily available as reaction partner for NH₂OH. Therefore, despite a much lower Mn content in our soils, NH₂OH will preferably react with Mn³⁺ or Mn⁴⁺, rather than with Fe³⁺. This phenomenon is also made use of in soil chemical analyses for the selective extraction of Mn with NH₂OH, while leaving the major part of the iron unaffected (Chao, 1972).

4.4.3. Isotopic signature of abiotically produced N₂O

The isotopic signature of N₂O, especially the ¹⁵N SP of N₂O, is considered as promising tool for disentangling the different N₂O production and consumption processes in soils (Baggs, 2008). In recent studies, it has been shown that the SP can be used to differentiate between N₂O production and consumption processes, i.e., nitrification and denitrification, albeit with substantial uncertainty (Ostrom and Ostrom, 2011). Only recently, Heil et al. (2014) found a remarkably constant SP in the range of 33.9–35.6‰ for different abiotic NH₂OH oxidation reactions in aqueous solution, that was very stable over time and different experimental conditions. Earlier, Toyoda et al. (2005) found a SP of 29.5 ± 1.1‰ for the oxidation of NH₂OH by MnO₂. In the present work with natural soils, we found the SP of the N₂O to be in the same range as in Heil et al. (2014). We used a two-way mixing model to calculate the isotopic composition of N₂O, so that the values given in Table 4.2 only represent the portion of N₂O produced by oxidation of added NH₂OH. Even if we confirmed the SP for abiotic N₂O formation found in solutions for soils, it is also in agreement with recent studies reporting on N₂O production during nitrification via microbial NH₂OH oxidation. In pure culture batch experiments, SP values of 33.5 ± 1.2‰, 32.5 ± 0.6‰, 35.6 ± 1.4‰, and 30.8 ± 5.9‰ were observed for *Nitrosomonas europaea*, *Nitrosomonas multiformis*, *Methylosinus trichosporium*, and *Methylococcus capsulatus*, respectively (Sutka et al., 2006; Sutka et al., 2003, 2004). Frame and Casciotti (2010) reported similar SP values for a marine nitrifying bacterium (36.3 ± 2.4‰; *Nitrosomonas marina* C-113a) and Santoro et al. (2011) found values for marine AOA that were only slightly lower but still in a range comparable to our results (30.3‰). Lately, Jung et al. (2014) found similar SP for AOA, but also found a strain with a SP as low as 13.1 ± 1.2‰, and thereby further complicating the picture. Until now, the large and partially overlapping ranges for the diverse N₂O production and consumption processes in soils strongly limit the use of SP for N₂O source partitioning. Further research on this topic and more data on individual processes are needed.

4.5. Conclusions

This study showed that at least some soils have the potential to oxidize NH₂OH to N₂O in a purely abiotic reaction, which emphasizes the possibility of a coupled biotic–abiotic production of N₂O during nitrification. We found this potential to be highly dependent on soil properties. Three factors that were found to possibly explain the capacity of the different soils to oxidize NH₂OH to N₂O were pH, C/N ratio, and Mn content, but further research is needed to evaluate the influence of the single parameters. Even if only a small fraction of NH₂OH is “leaking” into the soil during nitrification, it could be transformed to N₂O via fast chemical oxidation. At high nitrification rates, this could have great environmental consequences. On the basis of our findings we suggest a revision

of the ‘hole-in-the-pipe’ model for nitrification. We propose an abiotic N₂O production during nitrification that is mainly controlled by the “leakage” of NH₂OH from ammonia-oxidizing microorganisms and the properties of the surrounding soil. If this mechanism turns out to be relevant, this would have great implications for N₂O mitigation strategies, especially for agroecosystems with high fertilizer-induced nitrification rates in combination with a high soil pH and low organic carbon content with low C/N ratio.

Chapter 5

N₂O decomposition over hot and dry surfaces

5.1. Introduction

Although the findings by Junge et al. (1971) of low N₂O concentrations in air masses of Saharan origin have been explained by Rebert and Ausloos (1978) with a suggested tropospheric photochemical decomposition mechanism, this mechanism has since then not been studied in more detail. The photochemical and thermal decomposition of N₂O is a well-known process at elevated temperatures (Kondratenko and Pérez-Ramírez, 2006), but an absorption on dry particulate matter could potentially allow this destruction of N₂O to proceed at temperatures found on earth. As photolysis has also shown to play a role in N₂O production by a surface-catalyzed reaction (Rubasinghege et al., 2011), the verification of a similar process for the decomposition of N₂O would be of great importance for the understanding of the N cycle and could help to reduce the large uncertainties of the global N₂O budget.

An important factor for the relevance of the reaction is the rate of air mass flowing across a desert region in the mixed layer, in which the air stream can be mixed downward and come into contact with the desert surface. Based on the assumption of characteristic meteorological parameters for desert regions (1 km height of the boundary layer; mean wind speed of 10 m s⁻¹), Alyea et al. (1978) calculated that over a long desert transverse of 3000 km about 75% of the boundary layer air mass will be mixed downward to the surface layer. They concluded that only few nominal deserts (4.5 × 10⁶ km² surface area; the Sahara equals two nominal deserts) might lead to 15-20 year time constants for N₂O, at relatively low destruction efficiencies. This proposed mechanism would make deserts an effective sink in the troposphere for N₂O (Alyea et al., 1978).

However, this mechanism has not been considered since its discovery, but would be of great importance with increasing anthropogenic N₂O emissions, and would greatly improve modeling of the global N₂O cycle. The discovery of an additional tropospheric sink of global significance would largely expand our understanding of the global N₂O cycle and the global N₂O budget.

To show the photochemical decomposition of N₂O over warm and dry sand surfaces, a laboratory experiment was set up, using a flow-through reaction chamber in a closed loop connected to an infrared laser absorption spectrometer for online real-time analysis of N₂O mixing ratio. Quartz sand as the main constituent of continental deserts was chosen as the reactive surface, also in mixtures with the transition metal oxides ferric oxide (Fe₂O₃) and manganese oxide (MnO₂) that are commonly found as components of desert sands. Both iron and manganese oxides, have been shown to have a catalytic effect on the decomposition of N₂O at elevated temperatures (Kondratenko and Pérez-Ramírez, 2006; Yamashita and Vannice, 1996), thus it can be assumed that they also influence a potential decomposition mechanism in hot desert regions. Experimental conditions were chosen to resemble conditions typically found in desert regions with high intensity UV radiation, high surface temperatures, and dry air.

The use of laser absorption spectroscopy allows for a high-precision measurement of N₂O that is superior to that of gas chromatography, and additionally enables measurements at very high temporal resolution. Those two factors make laser spectroscopy an ideal tool to observe potentially low N₂O degradation rates at the laboratory scale.

5.2. Materials and Methods

For the determination of N₂O mixing ratios an infrared laser absorption spectrometer was used (Dual Laser Quantum Cascade Trace Gas Monitor, Aerodyne Research, Inc., Billerica, MA, USA). The instrument consists of two mid-infrared lasers that are able to measure N₂O, CO₂, CH₄, and H₂O simultaneously at a temporal resolution of up to 10 Hz. Water vapor is measured to correct for volumetric dilution and pressure broadening effects caused by increasing water vapor concentration in the sample air. Prior to every experiment the cell was flushed with synthetic air and a new background spectrum was taken. The instrumental precision of the measurements, expressed as standard deviation of the average N₂O mixing ratio at atmospheric level was <0.3 ppb.

The laser was connected to a flow-through reaction chamber in a closed loop. Dried hardware store quartz sand was used as reactive surface in our experiments. For testing the effect of iron and manganese oxides on N₂O decomposition, the quartz sand was also mixed with 2.5% (m/m) Fe₂O₃, and further additionally with 0.25% (m/m) MnO₂. The sand was dried prior to each experiment at 105 °C for at least 24 h. At the beginning of each experiment, the hot sand was taken out of the drying oven and was immediately filled into a flow-through reaction chamber. The chamber was custom-made of a 30 cm long quartz glass cylinder fitted with PTFE cover plates, and one connection at each side for in- and outlet. The PTFE plates were held together by seven aluminum rods at the outside of the chamber. The contact surfaces were sealed gastight with Viton® O-rings. A thermocouple was fitted inside the chamber to monitor the temperature close to the sand surface during the experiment. The 30 cm long chamber had a diameter of 14 cm, and was filled with sand just less than half corresponding to a sand surface area of approximately 420 cm². The chamber was then purged with 2.5 L min⁻¹ of a standard gas of known concentration of N₂O (250, 500, or 750 ppb balanced with N₂; 99.5% purity N₂O, Linde, Munich, Germany) or pressurized air of variable N₂O concentration (Forschungszentrum Jülich GmbH, Germany), controlled by a mass flow controller (Brooks Instruments, Dresden, Germany). When the whole system had equilibrated and a constant mixing ratio of N₂O was reached after a few minutes, magnetic 3-way valves (series 9, Parker Hannifin, Cleveland, OH, USA) were switched and the chamber was put into a closed loop, with the outlet of the chamber connected to the inlet of the laser and the outlet of the laser connected to the inlet of the chamber via a membrane pump (MVP 070-3, Pfeiffer Vacuum, Asslar, Germany) to achieve constant circulation (Fig. 5.1). Two 300 W UV-light (Ultra-Vitalux®, Osram,

Augsburg, Germany) that produce a radiation spectrum similar to that of natural sunlight, and two 250 W (Siccatherm®, Osram) infrared (IR)-light lamps with a dominant wavelength of 1100 nm and a low visible light fraction were placed 60 cm above the reaction chamber for high intensity UV radiation and to keep the surface temperature of the sand high, as found in hot desert regions. A bypass loop to detach the chamber from the closed loop and to shut it off completely was added to be able to run experiments also in batch mode.

For this thesis, five different experiments were conducted to study N₂O photodecomposition. In the beginning, two experiments (1 and 2) in a closed loop mode were carried out with quartz sand filled into the reaction chamber, first using a reference gas with sub-ambient N₂O mixing ratio (281 ppb), and then a second gas with above-ambient N₂O mixing ratio (500 ppb) over periods of 17 and 29 h, respectively. During these experiments the chamber was exposed to the UV and IR radiation of the four light sources over the complete experimental run. Further, an experiment was conducted under the same conditions, but with a simulated diurnal day/night cycle (6 h/16 h) that was achieved by switching the UV and IR radiation off during night (experiment 3). In a next step, the experiments 1 and 2 with a permanent light source were repeated under the same conditions as before for approximately 24 h, but the sand was additionally mixed with Fe₂O₃ and MnO₂ as described above (experiment 4). In contrast to the previously described measurements that were run in continuous closed-loop mode, a final experiment was conducted in batch mode (experiments 5), in which the reaction chamber was disconnected from the closed-loop and N₂O mixing ratios were measured repeatedly in three-hour intervals. Light conditions were the same as in the experiments with continuous light before.

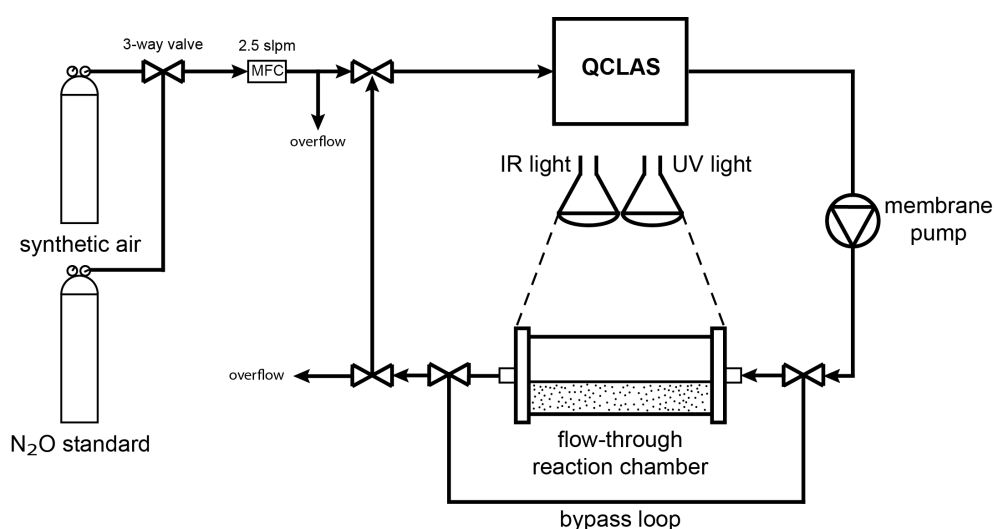

Figure 5.1: Schematic representation of the laboratory setup for the detection of photochemical N₂O decomposition over a hot and dry sand surface with a dynamic flow-through chamber coupled to a quantum cascade laser absorption spectrometer (QCLAS).

5.3. Results

With the performed experiments it was not possible to find a clear evidence for a N₂O decomposition mechanism that could be a potential sink for N₂O in hot desert regions. When a reference gas with a sub-ambient N₂O mixing ratio of 281 ppb was utilized, the closed loop experiments with high UV radiation and at high temperature of the sand surface (53 °C) revealed an increase of N₂O mixing ratios close to ambient levels over time (experiment 1; Fig. 5.2 A). When the chamber was filled with a reference gas with a higher than ambient N₂O mixing ratio (500 ppb), the opposite trend was observed, showing a gradual decrease to the ambient N₂O mixing ratio (experiment 2; Fig. 5.2 B). Both experiments shown in Fig. 5.2 were conducted under the same conditions, using two UV lamps and one IR lamp during the complete experimental run. In the beginning of the experiment with sub-ambient reference gas, the N₂O mixing ratio slightly decreased by 1 ppb over a period of 30 min and stayed at a level of about 281 ppb for about half an hour (Fig. 5.2. A). After this initial phase, the mixing ratio continuously increased until the end of the experiment. The experiment with a 500 ppb reference gas (Fig. 5.2 B) on the other hand showed the opposite trend, with N₂O mixing ratio decreasing from the beginning of the experiment. The speed of decrease slowed down as the mixing ratio approached the ambient level.

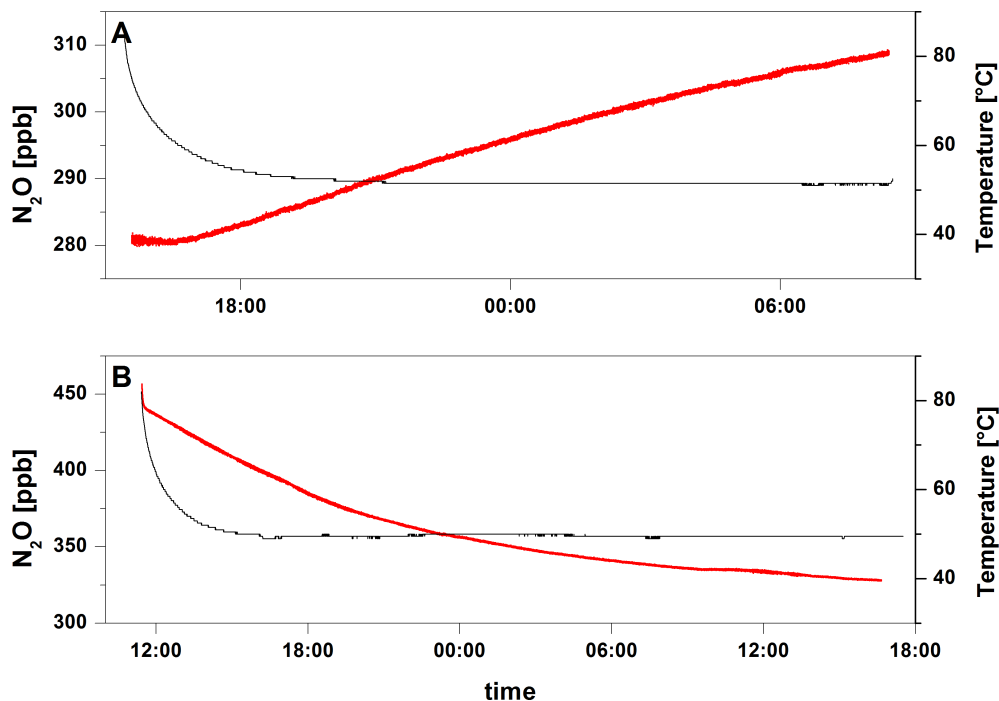

Figure 5.2: Nitrous oxide (N₂O) mixing ratios in ppb (red line) over time at a temporal resolution of 1 Hz and sand near-surface temperature in °C (black line) in closed-loop experiments with simulated hot desert daytime conditions in a dynamic flow-through reaction chamber filled about half-full with sand and irradiated with ultraviolet (UV) and infrared (IR) light. The system was flushed with pressurized air with 281 ppb N₂O in experiment 1 (A) and with a 500 ppb N₂O reference gas in experiment 2 (B) prior to the experiment.

Figure 5.3 shows the results of experiment 3 in which a diurnal day–night–day cycle (6 h/16 h/7 h) was simulated. The reference gas used to flush the system was dry pressurized air with a N₂O mixing ratio of 297 ppb. During daytime conditions, the chamber was irradiated with two UV lamps and one IR lamp, which we all switched off during night. During daytime conditions sand temperatures reached a maximum of 60 °C and cooled down to a temperature of 27 °C at the end of the night. At the beginning of the experiment, when daytime conditions were simulated, N₂O mixing ratios were relatively stable for about one hour. This stage was then followed by a steady increase of N₂O mixing ratio. With the beginning of nighttime conditions, the increase stopped, and for about three hours N₂O mixing ratios decreased. After the decrease phase, the mixing ratios gradually increased again until the next daytime light phase, when this increase was further enhanced up to the point, at which N₂O mixing ratios close to the atmospheric level (ca. 324 ppb) were reached. In contrast, water vapor mixing ratios behaved differently. Mixing ratios sharply decreased at the beginning of the experiment from the initial level of the pressurized air of 2400 ppm until a constant level of about 795 ppm at the end of the first daytime phase was reached. Upon the change from daytime to nighttime conditions, the same sharp decrease as at the beginning of the experiment could be observed. After this initial decrease, a low but steady increase in water vapor mixing ratio was observed at nighttime conditions. With the beginning of the second daytime phase a strong increase in water vapor was observed.

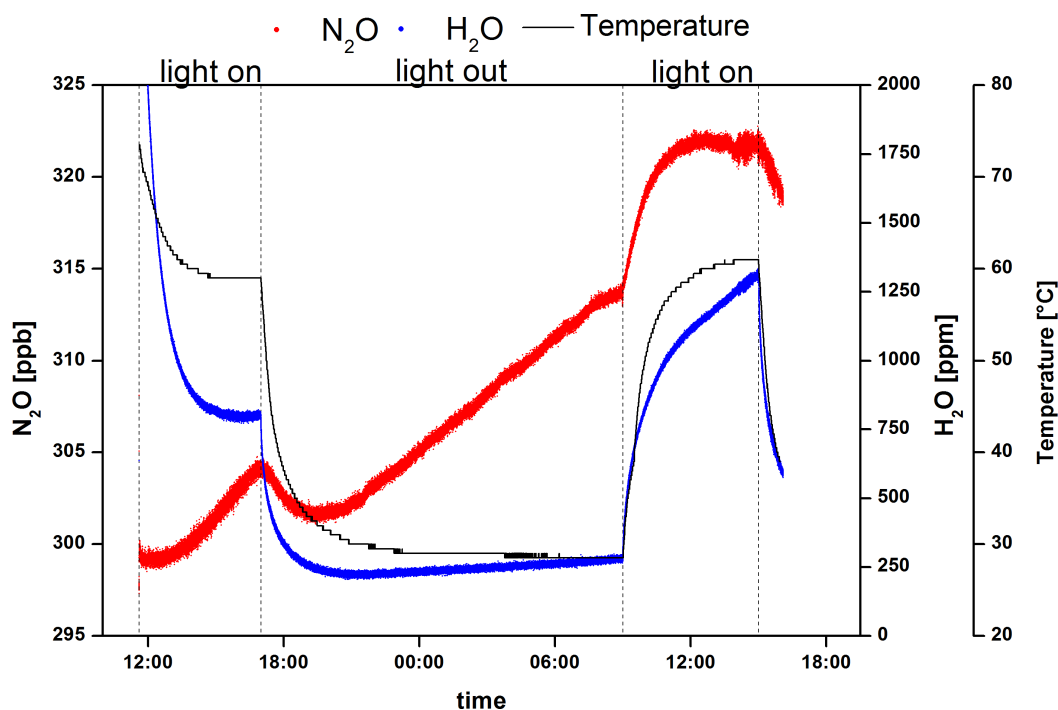

Figure 5.3: Nitrous oxide (N₂O) mixing ratios in ppb and water vapor (H₂O) mixing ratios in ppm over time at a temporal resolution of 1 Hz in a closed loop experiment (experiment 3) with a simulated diurnal day–night–day cycle in a dynamic flow-through reaction chamber filled about half-full with sand and irradiated with ultraviolet (UV) and infrared (IR) light during daytime conditions. The system was flushed with pressurized air (297 ppb N₂O) prior to the experiment.

As desert sand also includes other substances than silica, such as transition metal oxides, and as transition metal oxides could play an important role in surface-bound reaction mechanisms, further experiments with sand and metal oxide mixtures were conducted under the same conditions as in experiment 1. Experiment 4 with sand and Fe₂O₃ and MnO₂ mixture showed no significant difference compared to experiment 1 with pure quartz sand (Fig. 5.4) that has been conducted under the same conditions, so that a possible involvement of transition metals in an adsorption mechanism by silica sand could not be confirmed. The N₂O mixing ratio increased from the beginning of the experiment on until the ambient level was reached. By the end of the experiment, no further change in N₂O mixing ratio was observed. The water vapor mixing ratio, on the contrary, strongly decreased at the start of the experiment for about four hours down to 230 ppm, after which it gradually increased up to slightly above 1000 ppm until the end of the experiment.

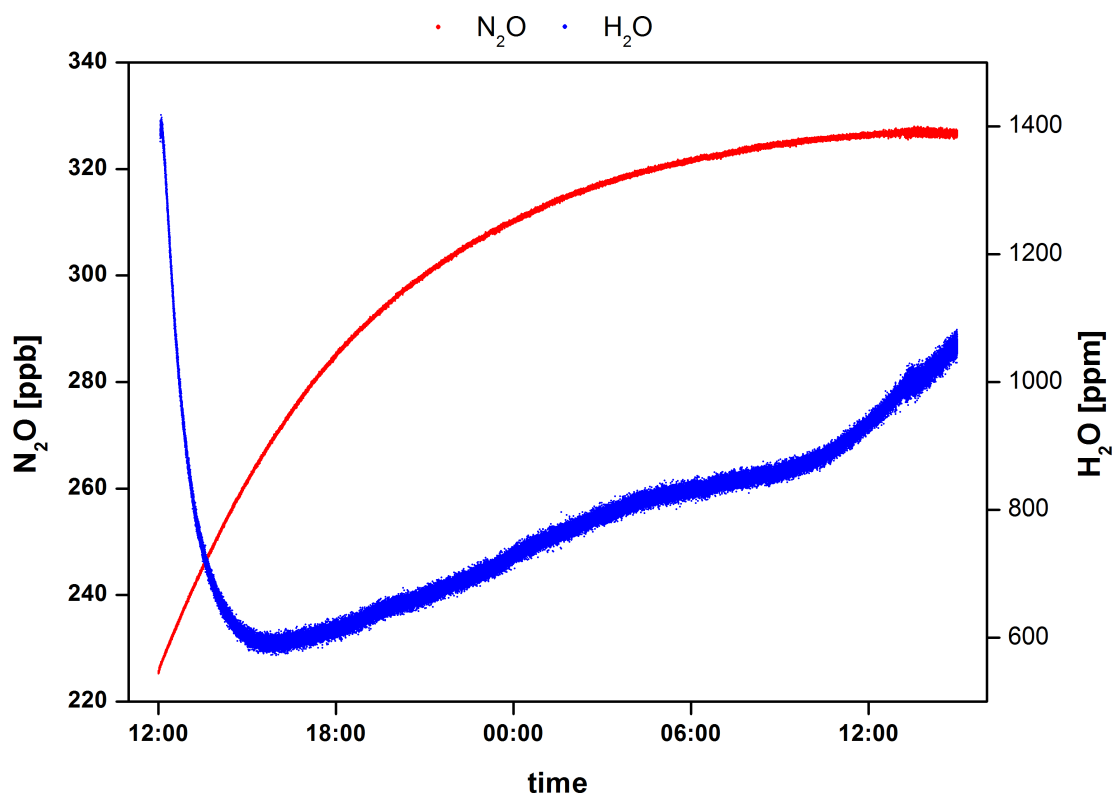

Figure 5.4: Nitrous oxide (N₂O) mixing ratios in ppb and water vapor (H₂O) mixing ratios in ppm over time at a temporal resolution of 1 Hz in a closed loop experiment (experiment 4) with simulated daytime conditions in a dynamic flow-through reaction chamber filled about half-full with sand mixed with 2.5% ferric oxide (Fe₂O₃) and manganese oxide 0.25% (MnO₂) and irradiated with ultraviolet (UV) and infrared (IR) light. The system was flushed with pressurized air (225 ppb N₂O) prior to the experiment.

As apparently a small leakage in the experimental setup led to the observed changes in N₂O mixing ratios, very likely at the stage of the membrane pump, experiment 5 was run in batch mode, thereby excluding the pump and the analyzer for the duration of the batch mode. For this, the chamber was filled with a mixture of a reference gas with a N₂O mixing ratio of 500 ppb and pressurized air (294

ppb N₂O) to obtain a N₂O mixing ratio close to the ambient level. After that, the chamber was disconnected from the pump and the analyzer by magnetic 3-way valves (Fig. 5.1). The closed chamber was exposed to the UV and IR radiation of two UV lamps and one IR lamp placed 60 cm above the chamber. This corresponded to a sand surface temperature of approximately 60 °C. After periods of three hours, the mixing ratio of N₂O in the chamber air was measured by switching the chamber back into loop mode for 5 min. The initial N₂O mixing ratio averaged over 5 min was 328.1 ± 0.2 ppb. After three hours the N₂O mixing ratio had decreased significantly to 325.9 ± 0.2 ppb. However, there was no further significant reduction in N₂O after another period of three hours, when the mixing ratio remained at a similar value of 325.7 ± 0.2 ppb. As the chamber itself was gastight, it can only be concluded that there was no photo-degradation of N₂O ongoing in the experiments, or the degradation rate was so low that a change in N₂O mixing ratio at the end of the experiment was below the detection limit.

5.4. Discussion

The results of the photo-degradation experiments clearly indicated a small but constant leakage in the loop system with ambient air diffusing into the system. There were several possible sources of leakage in the following way. The flow-through chamber and its connections could be excluded, as gas-tightness had been tested and no leakage had been detected at all. Another potential source of gas diffusion into the closed-loop system was the PTFE tubing. However, although N₂O can diffuse through the PTFE material (Dobson and Taylor, 1986), the permeability is low, but could explain part of the observed leakage. Another potential source of leakage was the membrane pump with its four membrane heads. Additionally, the adsorption cell of the laser spectrometer was found not to be gastight. These sources added up to the total leakage rate of the system that caused ambient air to slowly diffuse into the closed loop. By this, the results can only lead to the assumption that if the N₂O photo-degradation existed in hot desert regions and occurred in the experimental system simulating these desert conditions, it would have been smaller than the leakage rate found in the setup.

The simulated diurnal cycle in experiment 3 (Fig. 5.2) could also give no evidence of a N₂O photo-degradation. Moreover, it showed possible effects of adsorption and desorption on the sand surface that could, together with the leakage, explain the variability in the mixing ratios of N₂O and water vapor. At the beginning of the experiment, when the sand was still completely dry, the results showed signs of an adsorption of water vapor from the already relatively dry reference gas on the sand surface, until the adsorption capacity of the sand was reached. At the beginning of the night cycle, decreasing temperatures may have allowed even more water vapor to be adsorbed by the sand surface. Also N₂O might have been adsorbed during the cooling period of the sand. When the

temperature had stabilized to ambient laboratory conditions, and adsorption capacity was reached again, both mixing ratio curves of N₂O and water vapor describe the diffusion of ambient air into the loop through the leakage in the system. The strong increase of N₂O and water vapor mixing ratios with the warming up at the next daytime conditions could be explained by a desorption of previously adsorbed N₂O and water vapor. In this experiment, significantly more water vapor compared to N₂O was potentially adsorbed.

Diurnal variability of N₂O mixing ratios in the atmosphere has been reported in the past by several authors (Brice et al., 1977; Cicerone et al., 1978; Matthias et al., 1979; Pierotti et al., 1978) and has also been attributed to a potential tropospheric N₂O sink via photochemical decomposition as proposed by Rebbert and Ausloos (1978). Albeit a diurnal variation of N₂O mixing ratios could not be confirmed by Cofer et al. (1986), a potential sink for N₂O could exist at the regional scale, such as in hot desert regions (Pierotti et al., 1978). Although, the presented diurnal cycle results could not verify a N₂O decomposition process, they showed that potential absorption/desorption processes could explain small diurnal changes in N₂O mixing ratios.

Although some small decreases in N₂O mixing ratio were observed in experiments 1 and 3 (Fig. 5.2A and Fig. 5.3), they could more likely be associated with adsorption and not destruction of N₂O, as the decreases were only observed when the sand was still very dry at the beginning of the experiment or when it was cooling down from higher temperatures. Furthermore, these decreases were followed by strong increases in N₂O mixing ratio when temperatures increased again, likely by desorption. Beside potential adsorption of N₂O molecules to the sand surface, there was no evidence for any other N₂O-consuming process, such as photochemical destruction of N₂O.

Although it is known that transition metal oxides can have a catalytic effect on photochemical N₂O destruction (Kondratenko and Pérez-Ramírez, 2006; Yamashita and Vannice, 1996), this effect could not be shown for the potential N₂O decomposition over hot sand. As Rebbert and Ausloos (1978) stated, small amounts of water vapor would drastically reduce photolysis. This would mean that the presence of water vapor as low as in the present experiments would already suppress N₂O photolysis, and therefore this mechanism would not be of relevance in regions where water vapor mixing ratios exceed this threshold. On the contrary, if water vapor below this threshold does not suppress N₂O photo-degradation, the mechanism could still be of significance at longer timescales in very dry and hot desert regions, although it was not detectable in experiments of only several hours duration. The N₂O decomposition rate can anyway only be low, as Pierotti et al. (1978) only found small changes in N₂O mixing ratios in the large desert area of the Sahara.

5.5. Conclusions

With the presented experiments it could not be confirmed that a mechanism of N₂O photodecomposition over warm and dry sand surfaces existed, as suggested by Rebbert and Ausloos (1978). However, it can neither be confirmed nor denied that this mechanism exists. With the experimental setup it was not possible to detect the decomposition of N₂O, which is potentially very low within a short timeframe, due to limitations of the equipment as discussed above. It is also possible, that the rate is too low to be observed with the existing leakage rate, but could still be of environmental importance in large desert areas that allow for long residence times of air masses in such areas. That is why further research on this process is necessary, as this potential sink for N₂O would be the only known tropospheric sink for N₂O besides denitrification that can act as both a source and sink of N₂O. This would lead to a revision of the global N₂O budget, and a revision of existing models could help to close gaps in the global N₂O budget. A great part of this uncertainty is due to the uncertainty in the dominant loss term of N₂O (Ciais et al., 2013), and a newly discovered N₂O sink would imply that the previously estimated source strength of N₂O, which is derived via a top-down approach, was too low.

Chapter 6

Synopsis

6.1. Summary

This thesis was laid out to characterize abiotic N trace gas formation processes in soils that have been known for several years, but are still not well understood and are widely neglected in most current studies. The first part of the thesis was a review gathering knowledge about abiotic N trace gas formation processes that built the basis for designing the experiments. The experiments mainly focused on the abiotic production of N_2O from the nitrification intermediate NH_2OH , characterized the isotopic signature of abiotically produced N_2O , demonstrated abiotic N_2O formation in soils, but also looked at potential photochemical N_2O decomposition on hot and dry sand surfaces.

The second chapter of this thesis was a review that updated the information about the role of abiotic processes in the formation of gaseous N products in soils. Several reactions involving the nitrification intermediates NO_2^- and NH_2OH are known to produce the N trace gases NO and N_2O . These reactions are: (i) the self-decomposition of NO_2^- , (ii) reactions of NO_2^- with reduced metal cations, (iii) the nitrosation of NO_2^- by SOM, (iv) the reaction between NO_2^- and NH_2OH , and (v) the oxidation of NH_2OH by iron and manganese. The reactions were presented in great detail with their gaseous products, potential environmental relevance, and influential soil parameters. While the gathered information showed that these reactions could occur over a broad range of soil characteristics, it was also found that these reactions are ignored in most current studies in favor of biological N trace gas formation. Relatively few studies were found that tried to quantify the contribution of abiotic processes to total N trace gas emissions of soils, which leaves great uncertainty in emission models and mitigation strategies. The negligence was found to be mainly due to the simultaneous occurrence of biotic and microbial processes in close vicinity, which makes it difficult to discriminate between the different processes. The review revealed participation of the nitrification intermediates NO_2^- and NH_2OH in all known abiotic N trace gas formation processes. By this, the review emphasized a coupled biotic–abiotic mechanism, with biotic nitrification supplying the substrates that are subsequently converted abiotically to NO and N_2O . For the first time, these processes have been merged into a conceptual model explaining abiotic NO and N_2O formation during nitrification. In an outlook, the review further showed the potential of stable isotope techniques to disentangle the different N_2O production processes in soils. Based on the knowledge from the review, experiments were developed to characterize the abiotic processes.

The first experiments, presented in chapter three, looked at the site-specific isotopic signatures of abiotically produced N_2O , but prior to this, preliminary experiments were conducted using a QCLAS to study the contribution of different abiotic processes to NO and N_2O formation. It was observed that reactions involving NO_2^- mainly led to the formation of NO while reactions with NH_2OH mainly led to the formation of N_2O , as did the comproportionation of NO_2^- and NH_2OH . This comproportionation as well as the NO_2^- decomposition to NO were limited to low pH conditions (< pH 5.5), while reactions of NH_2OH with transition metals occurred over a wide pH range.

As the SP of ^{15}N in N_2O is a promising tool to give more insight into N_2O production processes, the SP of N_2O produced by different abiotic reactions that had been identified to lead to significant N_2O formation reactions, was determined in a laboratory study. All reactions involved the nitrification intermediate NH_2OH in combination with different soil constituents (NO_2^- , Fe^{3+} , Fe^{2+} , Cu^{2+}). The experiments were conducted in aqueous solution placed in flow-through reaction chambers. N_2O production and its four main isotopic species ($^{14}\text{N}^{14}\text{N}^{16}\text{O}$, $^{15}\text{N}^{14}\text{N}^{16}\text{O}$, $^{14}\text{N}^{15}\text{N}^{16}\text{O}$, $^{14}\text{N}^{14}\text{N}^{18}\text{O}$) were quantified simultaneously, online and at a temporal resolution of 1 Hz, using a QCLAS. Thereby, the study presents the first continuous analysis of $\delta^{18}\text{O}$ in N_2O . The experiments revealed the possibility of purely abiotic reactions over a wide range of acidity (pH 3–8) by different mechanisms: the reaction of NH_2OH with NO_2^- at low pH, the oxidation of NH_2OH by Fe^{3+} (pH 3–8), and the Cu^{2+} catalyzed autoxidation of NH_2OH at higher pH. The $\delta^{15}\text{N}$ and $\delta^{18}\text{O}$ of N_2O produced by these abiotic pathways were significantly different between reaction mechanisms and reaction conditions. The $\delta^{15}\text{N}$ of N_2O reflected the $\delta^{15}\text{N}$ of the precursors NH_2OH (-1.93‰) and NO_2^- (-27.0‰) only partially. Reactions with the same N substrate resulted in significantly different $\delta^{15}\text{N}$ values under different reaction conditions, which limits the identification of the N source from the bulk ^{15}N isotopic signature of N_2O . For $\delta^{18}\text{O}$ of N_2O , a similar picture emerged, very likely caused by complex O exchange processes between water and dissolved N species. All abiotic pathways showed a characteristic SP of $\delta^{15}\text{N}$ in N_2O of about 35‰. The SP was unaffected by process conditions such as pH, as well as the type of reaction, and remained constant during the experiments. These new findings contribute new information to the challenge of source partitioning of N_2O emissions from soils. As hypothesized, a distinct SP of N_2O was found, but as also assumed, this constant SP was in the same range as previously found for microbial nitrification and fungal denitrification.

As the first experiments only looked at abiotic N_2O formation from NH_2OH in aqueous solutions, further experiments, presented in chapter four, were conducted with natural soils to analyze whether this abiotic N_2O formation from NH_2OH can occur in soils. For this, N_2O formation from NH_2OH was studied in laboratory incubation experiments in cropland, grassland, and forest soils. Incubations were conducted with and without the addition of NH_2OH to non-sterile and sterile soil samples. N_2O evolution was quantified with gas chromatography and further analyzed with online laser absorption spectroscopy to get insight into the N_2O formation dynamics. Additionally, the isotopic signature of the produced N_2O ($\delta^{15}\text{N}$, $\delta^{18}\text{O}$, and ^{15}N SP) was analyzed with isotope ratio mass spectrometry. The different soils showed large differences in N_2O formation upon the addition of NH_2OH . While the forest soil samples showed hardly any N_2O evolution after addition of NH_2OH , immediate and very large formation of N_2O was observed in the cropland soil, also in sterilized samples. There were also differences in N_2O formation observed in soils subjected to different sterilization methods. Autoclaving significantly reduced N_2O emissions from most soils,

while chloroform fumigation reduced N_2O formation only slightly compared to non-sterile soils. The experiments could show that sterile soils can oxidize added NH_2OH abiotically, and that at least some of the soils used in the experiments, mainly the agricultural soil, had an oxidation potential for NH_2OH as hypothesized before. This oxidation potential was highly dependent on soil pH, C/N ratio, and manganese content, in descending order, as revealed by a correlation analysis. N_2O formation was lower at lower pH. This could be explained by the higher chemical stability of NH_2OH at a lower pH due to a higher degree of protonation of the NH_2OH molecule. A higher C/N ratio led to a significant reduction of abiotic N_2O , which could be explained by an increasing incorporation of NH_2OH into the organic material, especially with high C/N ratio, that could act as a competitive reaction for NH_2OH . High manganese content correlated with high N_2O formation, as manganese was shown to be able to oxidize NH_2OH to N_2O . Interestingly, no influence of iron on N_2O formation was observed, as obviously iron is bound too tightly in the soil matrix to be able to participate in the oxidation of NH_2OH to N_2O . The kinetics of the observed N_2O formation resembled the same immediate and strong formation of N_2O as for the equivalent abiotic reaction in aqueous solution. Also the temperature dependency of the reaction in soils corresponded to the thermodynamic behavior of a purely chemical reaction, so that it could be concluded that the observed NH_2OH -induced N_2O was largely of abiotic origin. The SP of ^{15}N in N_2O was in the same range as previously found for abiotic N_2O formation as well as for microbial nitrification and fungal denitrification. With these experiments it was possible to show that at least some soils can oxidize NH_2OH to N_2O as hypothesized. The results suggest a possible coupled biotic–abiotic production of N_2O during nitrification, e.g., due to leakage of the nitrification intermediate NH_2OH with subsequent reaction in the soil matrix.

The possibility of a potential N_2O decomposition mechanism via photolysis over hot sand surfaces was investigated in laboratory experiments as presented in chapter five. Laboratory experiments were designed, using a flow-through reaction chamber filled with sand coupled to a QCLAS in a closed loop to continuously monitor N_2O mixing ratios. Experimental conditions were chosen to simulate hot desert daytime conditions, i.e., high surface temperatures and high UV radiation. However, with the conducted experiments it was not possible to show a photochemical destruction of N_2O over hot sand surfaces. This was mainly due to a slight leakage of ambient air into the closed loop setup, so that no unambiguous conclusion could be drawn. However, it can be inferred that the potential photochemical process, if it exists, must have a low turnover rate, making it very hard to detect in a short timeframe. Thus, the existence of this process could neither be proven nor denied, and a potential involvement of transition metal oxides, such as iron and manganese oxide, could also not be observed.

6.2. Synthesis

The aim of this thesis was to evaluate the role of abiotic processes in N trace gas formation and decomposition in soils. Despite the fact that several reactions leading to the formation of NO or N₂O have been known for years, they are widely neglected in most current studies. This thesis compiles the scattered studies on known abiotic N trace gas formation processes and merges them into a conceptual model of abiotic N trace gas formation during microbial nitrification. Based on this model, experiments were designed to study N₂O formation by NH₂OH oxidation in soils. The experiments gave evidence of N₂O formation via abiotic NH₂OH oxidation, and influences of different soil parameters could be determined. With the obtained results, the hypothesis of a coupled biotic–abiotic N₂O formation, as presented in the conceptual model, could be partially confirmed.

The in-depth literature review, as presented in chapter two, allowed a comprehensive summary of all abiotic N₂O and NO production and consumption processes that are known to occur in soils. By compiling all known reactions, it was possible to divide abiotic N trace gas production processes into two groups. The first group included reactions involving NO₂⁻. These reactions largely lead to the formation of NO, with N₂O as a side product only, which have classically been labeled as chemodenitrification. The second group comprised the reactions involving NH₂OH, being responsible for the majority of abiotic N₂O formation. Additionally, an involvement of SOM in these mechanisms was found that has not been well investigated and that obviously plays an ambivalent role, i.e., on the one hand being able to abiotically fix mineral forms of N, and on the other hand being involved in N trace gas formation. Preliminary experiments could confirm this grouping into chemodenitrification, leading to mainly NO, and NH₂OH oxidation leading to N₂O formation. As the two precursors of abiotic N trace gas formation, NO₂⁻ and NH₂OH, are both intermediates of microbial nitrification, this thesis proposes a coupled biotic–abiotic production of N₂O, with nitrification providing the substrates, which are subsequently oxidized or reduced in a purely abiotic fashion. This coupled mechanism, with both abiotic and biotic processes proceeding at the same time, makes it very difficult to differentiate between both. This probably led to an underestimation of abiotic N trace gas formation in the past. While most of the occasional studies on abiotic N trace gas formation focused only on single processes or groups of processes, the comprehensive review in this thesis for the first time allowed a conceptualization of all known abiotic N₂O and NO, as well as HONO producing processes from nitrification intermediates NO₂⁻ and NH₂OH into one model. This conceptual model can be considered as a revision and extension of the ‘hole-in-the-pipe’ model (Firestone and Davidson, 1989). The model allows the explanation of the formation of N trace gases N₂O, NO, and HONO during nitrification by all known abiotic processes involved.

The production of NO via chemodenitrification is generally better understood and accepted than NH₂OH oxidation, as the precursor NO₂⁻ is, unlike NH₂OH, always released by AOB into the soil matrix. Although it generally does not accumulate in soils (see chapter 2.2), part of the NO₂⁻ can

undergo chemical decomposition primarily to NO. As HNO_2 rather than NO_2^- is the reactive species in these NO_2^- decomposition reactions, they are highly pH-dependent. This is why chemodenitrification is considered an important process for N trace gas loss only in acidic soils, e.g., in temperate coniferous forests (Kesik et al., 2006; Stange et al., 2000). NH_2OH oxidation was for a long time disregarded, primarily because of the non-detection of NH_2OH in soils. This could be explained by the highly reactive character of NH_2OH and the lack of a sensitive detection method, that has only very recently been introduced (Liu et al., 2014). The high reactivity and non-detection may be two reasons why abiotic N_2O production via NH_2OH oxidation has been neglected in favor of microbial pathways, and this is why the experiments designed for this thesis focused on trying to confirm the relevance of abiotic NH_2OH oxidation.

First experiments with the nitrification intermediates NO_2^- and NH_2OH in combination with several transition metals in solution supported the assumption of an abiotic oxidation of NH_2OH to N_2O . Experiments confirmed for one the assumption that reactions involving NO_2^- only, in the absence NH_2OH , produce mainly NO and that NH_2OH is required to produce significant amounts of N_2O . The results presented in chapter three showed that reactions of NH_2OH -induced N_2O formation are possible over a wide pH range in combination with several transition metals.

Interesting information could be gained from the isotopic data collected. The study showed that new quantum cascade laser absorption spectroscopy technology is a suitable tool for getting more insight into the N cycle, and potentially other biogeochemical cycles, with high precision and at a high temporal resolution. The new technology revealed interesting features of the examined abiotic reactions, as an inverse isotopic fractionation during the reaction of NH_2OH and Cu^{2+} , and the surprisingly stable and constant SP for all abiotic N_2O production processes that resembled the SP found for N_2O production during nitrification and fungal denitrification. It was shown that different experimental conditions exerted no influence on the measured SP. It could be assumed, that the SP is independent of the N substrate, and not necessarily represents the production mechanism, but rather the last intermediate product in the formation of N_2O , as assumed by some authors before (Fehling and Friedrichs, 2011; Toyoda et al., 2002). However, this limits the use of the SP for source partitioning N_2O emissions, as reflected in SP values in a similar range for abiotic NH_2OH oxidation and NH_2OH oxidation in cell cultures. Based on these results one can argue that both microbial and abiotic processes share the same last intermediate step in N_2O formation, or alternatively it could be interpreted that N_2O produced allegedly microbially during nitrification could in reality be derived from the chemical oxidation of the nitrification intermediate NH_2OH , released by AOB.

In chapter four experiments were brought to next level, in which reactions of NH_2OH with soil constituents and proposed mechanisms were tested in natural soils. The conducted experiments showed that at least some soils have a potential to oxidize NH_2OH in a purely abiotic way. This

potential was highly dependent on soil properties. The observed site-specific isotopic signature of N_2O produced in soils was in the same range as in the previous experiments, which is also the same range as for N_2O from nitrification and fungal denitrification. As the isotopic signatures could give no distinct evidence for an abiotic N_2O formation, incubation experiments with sterilized soils clearly showed that some soils can oxidize NH_2OH abiotically, as sterile samples showed similar N_2O production upon NH_2OH addition compared to non-sterile replicates. Even stronger evidence of an abiotic N_2O formation was given by a reaction kinetics study with a QCLAS. The fast character of the reaction resembles the reaction progress of NH_2OH oxidation found in the previous experiments in solution. Additionally, the temperature dependence of the reaction was as expected for a chemical reaction with pseudo-first-order kinetics, as observed for the oxidation of NH_2OH by Fe or Mn (Butler and Gordon, 1986). These results clearly demonstrated that NH_2OH added to grassland and agricultural soils was oxidized abiotically. In the environment, however, this N_2O formation will be controlled by the NH_2OH release rate by AOB and by the prevailing soil parameters as previously described in the conceptual model (Fig. 2.1).

An interesting feature when looking at the influential factors on abiotic N_2O formation was that Fe seemed to have no influence on the abiotic oxidation of NH_2OH , whereas Mn, albeit about a factor of ten lower in concentration than Fe, played a significant role in NH_2OH oxidation. It seemed as if the soil Fe was too tightly bound to be available for NH_2OH oxidation and that the role of Fe on NH_2OH oxidation was previously overestimated due to its generally high abundance, although Mn has the higher redox potential. SOM seems to play another important role in abiotic N_2O formation by binding NH_2OH to functional groups of lignin or dissolved humic acid and, thereby, suppressing its oxidation to N_2O , so that abiotic N_2O formation seems to be of minor importance in soils rich in organic matter. This incorporation of NH_2OH into SOM is expected to be highest at near neutral pH conditions (Thorn and Mikita, 2000).

This thesis gave strong evidence that abiotic N trace gas formation has to be considered when evaluating gaseous N emissions from soils. The abiotic NO formation via chemodenitrification is a process, which has to be considered for acidic soils. Although conditions favorable for NO_2^- accumulation usually do not coincide with conditions favorable for NO_2^- decomposition, the processes could be of significance in strongly acidic soils, in which NO_2^- can be quickly decomposed before being converted to NO_3^- via nitrification. The N_2O formation via NH_2OH oxidation, on the other hand, is obviously underrepresented in N_2O emission studies, as this thesis demonstrated that it can be a relevant process, e.g., in agricultural soils with high nitrification rates, a high pH, and low organic C. It can be assumed that at least a certain part of N_2O emissions previously attributed to microbial processes is of chemical origin, albeit with an uncertainty of its magnitude and contribution to total soil N_2O emissions.

In the last part of the thesis, experiments have been conducted to verify a potential decomposition mechanism over hot and dry surfaces. Although an abiotic N_2O trace gas decomposition reaction had been reported in the past, it could not be identified with the experimental setup used in this thesis. That said, the conducted experiments could neither confirm nor negate the existence of such a mechanism. As discussed above, the experimental setup had limitations that allowed ambient air to diffuse into the closed loop system and thus masked potential N_2O decomposition in the closed system. It can only be concluded that if a photochemical decomposition of N_2O in hot desert areas existed, the rate of this process is potentially very low in a short timeframe. However, with long desert transects resulting in long residence times of air masses in hot desert regions, this process could still be a significant sink of N_2O at a global level.

6.3. Perspectives

6.3.1. Source partitioning of N_2O using stable isotopes

Great expectations have been set into the source partitioning of different N_2O emission sources using stable isotopes, especially using the site-specific ^{15}N isotope data. Although at present this site-specific ^{15}N isotope information can only be used to differentiate between oxidative and reductive N_2O emission sources (Decock and Six, 2013), and the results gained in this thesis cannot be used to differentiate between microbial and abiotic NH_2OH oxidation, recent advances in research on the isotopic composition of N_2O from denitrification under oxic and anoxic conditions (Lewicka-Szczebak et al., 2015) and from fungal denitrification (Rohe et al., 2014) show a progress in this field by adding new fractionation factors and SP values for the differentiation between distinct conditions and microorganisms. Even if with this thesis no differentiation between biotic and abiotic processes was possible, new information about the behavior of fractionation over time could be gained using latest quantum cascade laser absorption spectroscopy technology that was not possible with older IRMS instruments.

With recent advances in technology, like infrared laser spectroscopy for SP measurements in N_2O having become commercially available, more high-resolution data on different processes under a range of conditions could be gained in the near future, giving a deeper insight into the isotope fractionation by different processes and bringing new chances for a possible source partitioning. Another issue is the comparability of data from different laboratories because of the lack of international standards for $\delta^{15}\text{N}^{\text{bulk}}$ and SP in of N_2O . However, although there still is no standard for SP, recent efforts in form of interlaboratory comparison studies, such as by Mohn et al. (2014), will help to improve comparability of results between different laboratories.

6.3.2. Abiotic NH_2OH oxidation in soils

As suggested in chapter 4.4.2, abiotic N_2O formation could potentially be explained by three soil parameters: pH, C/N ratio, and Mn content. However, this study relies only on relatively few data points. For a proper prediction using soil parameters, a more substantial study would be needed. The problem of collinearity exists as well, so that studies on the influence of each single parameter are necessary to confirm the influence of the three identified soil parameters on the oxidation of NH_2OH in soils. It is possible that not all of the three parameters exert influence on abiotic N_2O formation. Although the influence of all three parameters can be explained chemically, especially the influence of the C/N ratio of SOM is unclear. Further studies with soils covering a broader range of C/N ratios and SOM composition are needed, including a characterization of the binding forms of N in the SOM.

Although this dissertation could show that at least some soils have the potential to oxidize the nitrification intermediate NH_2OH to form N_2O , the greatest uncertainty with respect to the coupled biotic–abiotic production of N_2O in soils is the release of NH_2OH by AOB or also AOA. While it has been shown in the past that different AOB strains released NH_2OH in cell cultures (Schmidt et al., 2004b; Stüven et al., 1992), this has not yet been reported from soils, although only recently it was possible to detect NH_2OH with a novel method in an acidic spruce forest soil (Liu et al., 2014). Further research on AOB and AOA and their release of NH_2OH is vital for a better understanding of biotic and abiotic N_2O formation, as this is the key step in the whole process. Without the release of NH_2OH there would potentially be no abiotic N_2O formation in soils. To determine the leakage rate of NH_2OH of AOB, AOA, or other soil microorganisms, will be a great effort for microbiologists because it would presumably be different for different bacterial strains and highly dependent on environmental conditions and stresses acting on the microorganisms, such as nutrient or oxygen availability. As it has been shown that AOA can outnumber AOB in most soils (Leininger et al., 2006), AOA could play an even more important role in this process than AOB; yet, little is known about their metabolism, that could be significantly different from that of AOB.

However, if an average leakage rate of NH_2OH from nitrification for different environments could be determined, this would allow – in conjunction with the knowledge about the basic soil parameters (as discussed above) – to estimate the abiotic N_2O production for single ecosystems based on the nitrification rate. Although there is still a lot of research on several unknown variables needed, this thesis shows that a prediction of abiotic N_2O formation based on nitrification rate and different soil parameters could be possible and should be the ultimate goal of studies on NH_2OH -induced N_2O formation, as it would greatly improve modeling of N_2O emissions from soil. Furthermore, mitigation strategies could be improved, as N_2O emissions might have been previously incorrectly connected to other production processes, so that better mitigation strategies could be designed aligned with the relevant processes.

6.3.3. N₂O decomposition over hot and dry surfaces

There should also be more research on the presented N₂O decomposition mechanism. Although this thesis could not confirm the existence of such a mechanism at conditions found in the environment, the failure to do so, however, could have been mainly due to the instrumentation and experimental setup. Recent instrumentation is already capable of detecting small changes in N₂O, but the setup needs to be improved to achieve a perfect gas-tightness of the system. New long-term experiments with such an improved gas-tightness might reveal the presence of this mechanism as a sink for N₂O in the troposphere, which could change our understanding of the atmospheric lifetime and cycling of N₂O dramatically.

References

- Alyea, F.N., Cunnold, D.M. and Prinn, R.G. (1978) Meteorological constraints on tropospheric halocarbon and nitrous oxide destructions by siliceous land surfaces. *Atmos. Environ.* **12**, 1009-1011.
- Arp, D.J. and Stein, L.Y. (2003) Metabolism of inorganic N compounds by ammonia-oxidizing bacteria. *Crit. Rev. Biochem. Molec. Biol.* **38**, 471-495.
- Baggs, E., Smales, C. and Bateman, E. (2010) Changing pH shifts the microbial source as well as the magnitude of N₂O emission from soil. *Biol. Fert. Soils* **46**, 793-805.
- Baggs, E.M. (2008) A review of stable isotope techniques for N₂O source partitioning in soils: recent progress, remaining challenges and future considerations. *Rapid Commun. Mass Spectrom.* **22**, 1664-1672.
- Beaumont, H.J.E., Hommes, N.G., Sayavedra-Soto, L.A., Arp, D.J., Arciero, D.M., Hooper, A.B., Westerhoff, H.V. and van Spanning, R.J.M. (2002) Nitrite reductase of *Nitrosomonas europaea* is not essential for production of gaseous nitrogen oxides and confers tolerance to nitrite. *J. Bacteriol.* **184**, 2557-2560.
- Berger, S., Jung, E., Köpp, J., Kang, H. and Gebauer, G. (2013) Monsoon rains, drought periods and soil texture as drivers of soil N₂O fluxes – Soil drought turns East Asian temperate deciduous forest soils into temporary and unexpectedly persistent N₂O sinks. *Soil Biol. Biochem.* **57**, 273-281.
- Bezdicsek, D.F., MacGregor, J.M. and Martin, W.P. (1971) The influence of soil-fertilizer geometry on nitrification and nitrite accumulation. *Soil Sci. Soc. Am. Proc.* **35**, 997-1002.
- Billings, S.A. (2008) Biogeochemistry: nitrous oxide in flux. *Nature* **456**, 888-889.
- Blackmer, A.M. and Cerrato, M.E. (1986) Soil properties affecting formation of nitric oxide by chemical reactions of nitrite. *Soil Sci. Soc. Am. J.* **50**, 1215-1218.
- Bock, E., Koops, H.-P. and Harms, H. (1986) Cell biology of nitrifying bacteria. In *Nitrification* (ed. Prosser, J.I.). IRL Press, Oxford. pp. 17-38.
- Bol, R., Toyoda, S., Yamulki, S., Hawkins, J.M.B., Cardenas, L.M. and Yoshida, N. (2003) Dual isotope and isotopomer ratios of N₂O emitted from a temperate grassland soil after fertiliser application. *Rapid Commun. Mass Spectrom.* **17**, 2550-2556.
- Bonner, F.T., Dzelzkalns, L.S. and Bonucci, J.A. (1978) Properties of nitroxyl as intermediate in nitric oxide hydroxylamine reaction and in trioxodinitrate decomposition. *Inorg Chem* **17**, 2487-2494.
- Bonner, F.T. and Hughes, M.N. (1988) The aqueous solution chemistry of nitrogen in low positive oxidation states. *Comments Inorg. Chem.* **7**, 215-234.

- Bothner-By, A. and Friedman, L. (1952) The reaction of nitrous acid with hydroxylamine. *J. Chem. Phys.* **20**, 459-462.
- Boudot, J.P. and Chone, T. (1985) Internal nitrogen cycling in two humic-rich acidic soils. *Soil Biol. Biochem.* **17**, 135-142.
- Bremner, J.M. (1997) Sources of nitrous oxide in soils. *Nutr. Cycl. Agroecosys.* **49**, 7-16.
- Bremner, J.M., Blackmer, A.M. and Waring, S.A. (1980) Formation of nitrous oxide and dinitrogen by chemical decomposition of hydroxylamine in soils. *Soil Biol. Biochem.* **12**, 263-269.
- Bremner, J.M. and Führ, F. (1966) Tracer studies of the reaction of soil organic matter with nitrite. In *The use of isotopes in soil organic matter studies*. Pergamon, Oxford. pp. 337-346.
- Brenninkmeijer, C.A.M. and Röckmann, T. (1999) Mass spectrometry of the intramolecular nitrogen isotope distribution of environmental nitrous oxide using fragment-ion analysis. *Rapid Commun. Mass Spectrom.* **13**, 2028-2033.
- Brice, K.A., Eggleton, A.E.J. and Penkett, S.A. (1977) An important ground surface sink for atmospheric nitrous oxide. *Nature* **268**, 127-129.
- Brons, H.J., Hagen, W.R. and Zehnder, A.J.B. (1991) Ferrous iron dependent nitric oxide production in nitrate reducing cultures of *Escherichia coli*. *Arch. Microbiol.* **155**, 341-347.
- Bruelheide, H. and Udelhoven, P. (2005) Correspondence of the fine-scale spatial variation in soil chemistry and the herb layer vegetation in beech forests. *Forest Ecol. Manag.* **210**, 205-223.
- Burns, L.C., Stevens, R.J. and Laughlin, R.J. (1996) Production of nitrite in soil by simultaneous nitrification and denitrification. *Soil Biol. Biochem.* **28**, 609-616.
- Burns, L.C., Stevens, R.J., Smith, R.V. and Cooper, J.E. (1995) The occurrence and possible sources of nitrite in a grazed, fertilized, grassland soil. *Soil Biol. Biochem.* **27**, 47-59.
- Butler, J.H. and Gordon, L.I. (1986) Rates of nitrous oxide production in the oxidation of hydroxylamine by iron(III). *Inorg. Chem.* **25**, 4573-4577.
- Butterbach-Bahl, K., Baggs, E.M., Dannenmann, M., Kiese, R. and Zechmeister-Boltenstern, S. (2013) Nitrous oxide emissions from soils: how well do we understand the processes and their controls? *Phil. Trans. R. Soc. B* **368**.
- Chain, P., Lamerdin, J., Larimer, F., Regala, W., Lao, V., Land, M., Hauser, L., Hooper, A., Klotz, M., Norton, J., Sayavedra-Soto, L., Arciero, D., Hommes, N., Whittaker, M. and Arp, D. (2003) Complete genome sequence of the ammonia-oxidizing bacterium and obligate chemolithoautotroph *Nitrosomonas europaea*. *J. Bacteriol.* **185**, 2759-2773.
- Chalk, P.M., Keeney, D.R. and Walsh, L.M. (1975) Crop recovery and nitrification of fall and spring applied anhydrous ammonia. *Agron. J.* **67**, 33-37.
- Chalk, P.M. and Smith, C.J. (1983) Chemodenitrification. In *Gaseous loss of nitrogen from plant-soil systems* (eds. Freney, J.R. and Simpson, J.R.). Nijhoff/Junk, The Hague. pp. 65-89.

- Chao, T.T. (1972) Selective dissolution of manganese oxides from soils and sediments with acidified hydroxylamine hydrochloride. *Soil Sci. Soc. Am. Proc.* **36**, 764-768.
- Chao, T.T. and Kroontje, W. (1966) Inorganic nitrogen transformations through oxidation and reduction of iron. *Soil Sci. Soc. Am. Proc.* **30**, 193-196.
- Chapman, H.D. and Liebig, G.F. (1952) Field and laboratory studies of nitrite accumulation in soils. *Soil Sci. Soc. Am. Proc.* **16**, 276-282.
- Chapuis-Lardy, L., Wrage, N., Metay, A., Chotte, J.L. and Bernoux, M. (2007) Soils, a sink for N₂O? A review. *Glob. Change Biol.* **13**, 1-17.
- Cheng, W., Tsuruta, H., Chen, G. and Yagi, K. (2004) N₂O and NO production in various Chinese agricultural soils by nitrification. *Soil Biol. Biochem.* **36**, 953-963.
- Christianson, C.B. and Cho, C.M. (1983) Chemical denitrification of nitrite in frozen soils. *Soil Sci. Soc. Am. J.* **47**, 38-42.
- Ciais, P., Sabine, C., Bala, G., Bopp, L., Brovkin, V., Canadell, J., Chhabra, A., DeFries, R., Galloway, J., Heimann, M., Jones, C., Le Quéré, C., Myneni, R.B., Piao, S. and Thornton, P. (2013) Carbon and other biogeochemical cycles. In *Climate Change 2013: The Physical Science Basis. Contribution of Working Group I to the Fifth Assessment Report of the Intergovernmental Panel on Climate Change* (eds. Stocker, T.F., Qin, D., Plattner, G.-K., Tignor, M., Allen, S.K., Boschung, J., Nauels, A., Xia, Y., Bex, V. and Midgley, P.M.). Cambridge University Press, Cambridge & New York. pp. 465-570.
- Cicerone, R.J., Shetter, J.D., Stedman, D.H., Kelly, T.J. and Liu, S.C. (1978) Atmospheric N₂O: Measurements to determine its sources, sinks, and variations. *J. Geophys. Res. Oceans* **83**, 3042-3050.
- Clark, F.E. (1962) Losses of nitrogen accompanying nitrification. In: *Int. Soc. Soil Sci., Trans. Comm. IV and V*, Palmerston, New Zealand. pp. 173-176.
- Coby, A.J. and Picardal, F.W. (2005) Inhibition of NO₃⁻ and NO₂⁻ reduction by microbial Fe(III) reduction: Evidence of a reaction between NO₂⁻ and cell surface-bound Fe²⁺. *Appl. Environ. Microbiol.* **71**, 5267-5274.
- Cofer, W.R., Connors, V.S., Levine, J.S. and Edahl, R.A. (1986) Day and night profiles of tropospheric nitrous oxide. *J. Geophys. Res. Atmos.* **91**, 11911-11914.
- Cole, J.A. (1994) Biodegradation of inorganic N compounds. In *Biochemistry of microbial degradation* (ed. Ratledge, C.). Kluwer, London. pp. 487-512.
- Colman, B.P., Fierer, N. and Schimel, J.P. (2007) Abiotic nitrate incorporation in soil: is it real? *Biogeochemistry* **84**, 161-169.
- Colman, B.P., Fierer, N. and Schimel, J.P. (2008) Abiotic nitrate incorporation, anaerobic microsites, and the ferrous wheel. *Biogeochemistry* **91**, 223-227.
- Conrad, R. (1996) Soil microorganisms as controllers of atmospheric trace gases (H₂, CO, CH₄, OCS, N₂O, and NO). *Microbiol. Rev.* **60**, 609-640.

- Cooper, D.C., Picardal, F.W., Schimmelmann, A. and Coby, A.J. (2003) Chemical and biological interactions during nitrate and goethite reduction by *Shewanella putrefaciens* 200. *Appl. Environ. Microb.* **69**, 3517-3525.
- Crutzen, P.J. (1970) The influence of nitrogen oxides on atmospheric ozone content. *Quart. J. R. Met. Soc.* **96**, 320-325.
- Crutzen, P.J. (1979) The role of NO and NO₂ in the chemistry of the troposphere and stratosphere. *Annu. Rev. Earth Planet. Sci.* **7**, 443-472.
- Dail, D.B., Davidson, E.A. and Chorover, J. (2001) Rapid abiotic transformation of nitrate in an acid forest soil. *Biogeochemistry* **54**, 131-146.
- Davidson, E.A. (2009) The contribution of manure and fertilizer nitrogen to atmospheric nitrous oxide since 1860. *Nat. Geosci.* **2**, 659-662.
- Davidson, E.A., Chorover, J. and Dail, D.B. (2003) A mechanism of abiotic immobilization of nitrate in forest ecosystems: the ferrous wheel hypothesis. *Glob. Change Biol.* **9**, 228-236.
- Davidson, E.A., Vitousek, P.M., Matson, P.A., Riley, R. and Garciamendez, G. (1991) Soil emissions of nitric oxide in a seasonally dry tropical forest of México. *J. Geophys. Res.* **96**, 15439-15445.
- De Boer, W. and Kowalchuk, G.A. (2001) Nitrification in acid soils: micro-organisms and mechanisms. *Soil Biol. Biochem.* **33**, 853-866.
- De La Torre, J.R., Walker, C.B., Ingalls, A.E., Könneke, M. and Stahl, D.A. (2008) Cultivation of a thermophilic ammonia oxidizing archaeon synthesizing crenarchaeol. *Environ Microbiol* **10**, 810-818.
- Decock, C. and Six, J. (2013) How reliable is the intramolecular distribution of ¹⁵N in N₂O to source partition N₂O emitted from soil? *Soil Biol. Biochem.* **65**, 114-127.
- Delucchi, M., Murphy, J., Kim, J. and McCubbin, D. (1996) The cost of crop damage caused by ozone air pollution from motor vehicles. In: *The Annualized Social Cost of Motor Vehicle Use in the U.S., based on 1990 - 1991 data*. Institute of Transportation Studies University of California, Davis, CA, Davis.
- Denman, K.L., Brasseur, G., Chidthaisong, A., Ciais, P., Cox, P.M., Dickinson, R.E., Hauglustaine, D., Heinze, C., Holland, E., Jacob, D., Lohmann, U., Ramachandran, S., da Silva Dias, P.L., Wofsy, S.C. and Zhang, X. (2007) Couplings between changes in the climate system and biogeochemistry. In: *Climate Change 2007: The Physical Science Basis. Contribution of Working Group I to the Fourth Assessment Report of the Intergovernmental Panel on Climate Change* (eds. Solomon, S., Qin, D., Manning, M., Chen, Z., Marquis, M., Averyt, K.B., Tignor, M. and Miller, H.L.). Cambridge University Press, Cambridge & New York. pp. 499-587.
- Di, H.J., Cameron, K.C., Shen, J.P., Winefield, C.S., O'Callaghan, M., Bowatte, S. and He, J.Z. (2009) Nitrification driven by bacteria and not archaea in nitrogen-rich grassland soils. *Nature Geosci* **2**, 621-624.

- Ding, W.X., Yagi, K., Cai, Z.C. and Han, F.X. (2010) Impact of long-term application of fertilizers on N₂O and NO production potential in an intensively cultivated sandy loam soil. *Water Air Soil Pollut.* **212**, 141-153.
- Dobson, J.V. and Taylor, M.J. (1986) The permeability of gases through PTFE and other membranes at 25°C. *Electrochim. Acta* **31**, 231-233.
- Döring, C. and Gehlen, H. (1961) Über die Kinetik der Reaktion zwischen Hydroxylamin und salpetriger Säure. *Z. Anorg. Chem.* **312**, 32-44.
- Fehling, C. and Friedrichs, G. (2011) Dimerization of HNO in aqueous solution: an interplay of solvation effects, fast acid–base equilibria, and intramolecular hydrogen bonding? *J. Am. Chem. Soc.* **133**, 17912-17922.
- Firestone, M.K. and Davidson, E.A. (1989) Microbiological basis of NO and N₂O production and consumption in soil. In *Exchange of trace gases between terrestrial ecosystems and the atmosphere* (eds. Andreae, M.O. and Schimel, D.S.). Wiley, New York. pp. 7-21.
- Fitzhugh, R.D., Lovett, G.M. and Venterea, R.T. (2003) Biotic and abiotic immobilization of ammonium, nitrite, and nitrate in soils developed under different tree species in the Catskill Mountains, New York, USA. *Glob. Change Biol.* **9**, 1591-1601.
- Frame, C.H. and Casciotti, K.L. (2010) Biogeochemical controls and isotopic signatures of nitrous oxide production by a marine ammonia-oxidizing bacterium. *Biogeosciences* **7**, 2695-2709.
- Führ, F. and Bremner, J.M. (1964a) Untersuchungen zur Fixierung des Nitrit-Stickstoffs durch die organische Masse des Bodens. *Landwirt. Forsch.* **SH 18**, 43-51.
- Führ, F. and Bremner, J.M. (1964b) Beeinflussende Faktoren in der Fixierung des Nitrit-Stickstoffs durch die organische Masse des Bodens. *Atompraxis* **10**, 109-113.
- Galloway, J.N., Dentener, F.J., Capone, D.G., Boyer, E.W., Howarth, R.W., Seitzinger, S.P., Asner, G.P., Cleveland, C.C., Green, P.A., Holland, E.A., Karl, D.M., Michaels, A.F., Porter, J.H., Townsend, A.R. and Vorosmarty, C.J. (2004) Nitrogen cycles: past, present, and future. *Biogeochemistry* **70**, 153-226.
- Gärdenäs, A.I., Agren, G.I., Bird, J.A., Clarholm, M., Hallin, S., Ineson, P., Kätterer, T., Knicker, H., Nilsson, S.I., Näsholm, T., Ogle, S., Paustian, K., Persson, T. and Stendahl, J. (2011) Knowledge gaps in soil carbon and nitrogen interactions - From molecular to global scale. *Soil Biol. Biochem.* **43**, 702-717.
- Gelfand, I. and Yakir, D. (2008) Influence of nitrite accumulation in association with seasonal patterns and mineralization of soil nitrogen in a semi-arid pine forest. *Soil Biol. Biochem.* **40**, 415-424.
- Goldberg, S.D. and Gebauer, G. (2009) Drought turns a Central European Norway spruce forest soil from an N₂O source to a transient N₂O sink. *Global Change Biol.* **15**, 850-860.
- Groeneweg, J., Sellner, B. and Tappe, W. (1994) Ammonia oxidation in *Nitrosomonas* at NH₃ concentrations near K_m : Effects of pH and temperature. *Water Res* **28**, 2561-2566.

- Gruber, N. and Galloway, J.N. (2008) An Earth-system perspective of the global nitrogen cycle. *Nature* **451**, 293-296.
- Grunditz, C. and Dalhammar, G. (2001) Development of nitrification inhibition assays using pure cultures of *Nitrosomonas* and *Nitrobacter*. *Water Res* **35**, 433-440.
- Hansen, H.C.B., Borggaard, O.K. and Sørensen, J. (1994) Evaluation of the free-energy of formation of Fe(II)-Fe(III) hydroxide-sulfate (green rust) and its reduction of nitrite. *Geochim. Cosmochim. Acta* **58**, 2599-2608.
- Harter, R.D. and Ahlrichs, J.L. (1967) Determination of clay surface acidity by infrared spectroscopy. *Soil Sci. Soc. Am. J.* **31**, 30-33.
- Hauck, R.D. and Stephenson, H.F. (1965) Nitrogen sources, nitrification of nitrogen fertilizers. Effect of nitrogen source, size and pH of granule, and concentration. *J. Agric. Food Chem.* **13**, 486-492.
- Heil, J., Wolf, B., Brüggemann, N., Emmenegger, L., Tuzson, B., Vereecken, H. and Mohn, J. (2014) Site-specific ¹⁵N isotopic signatures of abiotically produced N₂O. *Geochim. Cosmochim. Acta* **139**, 72-82.
- Hooper, A.B. and Terry, K.R. (1979) Hydroxylamine oxidoreductase of *Nitrosomonas* production of nitric-oxide from hydroxylamine. *Biochim. Biophys. Acta* **571**, 12-20.
- Hughes, M.N. and Stedman, G. (1963) Kinetics and mechanism of reaction between nitrous acid and hydroxylamine. Part I. *J. Chem. Soc.*, 2824-2830.
- Islam, A., Chen, D., White, R.E. and Weatherley, A.J. (2008) Chemical decomposition and fixation of nitrite in acidic pasture soils and implications for measurement of nitrification. *Soil Biol. Biochem.* **40**, 262-265.
- Jenkinson, D.S. and Powlson, D.S. (1976) The effects of biocidal treatments on metabolism in soil—V: A method for measuring soil biomass. *Soil Biol. Biochem.* **8**, 209-213.
- Jones, M.L., Liehr, S.K., Classen, J.J. and Robarge, W. (2000) Mechanisms of dinitrogen gas formation in anaerobic lagoons. *Adv. Environ. Res.* **4**, 133-139.
- Jung, M.-Y., Well, R., Min, D., Giesemann, A., Park, S.-J., Kim, J.-G., Kim, S.-J. and Rhee, S.-K. (2014) Isotopic signatures of N₂O produced by ammonia-oxidizing archaea from soils. *ISME J* **8**, 1115-1125.
- Junge, C., Bockholt, B., Schütz, K. and Beck, R. (1971) N₂O measurements in air and seawater over the Atlantic. *Meteor Forschungsergebnisse Reihe B* **6**, 1-11.
- Kaiser, J., Röckmann, T. and Brenninkmeijer, C.A.M. (2003) Complete and accurate mass spectrometric isotope analysis of tropospheric nitrous oxide. *J. Geophys. Res.* **108**, 4476.
- Kampschreur, M.J., Kleerebezem, R., de Vet, W.W.J.M. and van Loosdrecht, M.C.M. (2011) Reduced iron induced nitric oxide and nitrous oxide emission. *Water Res.* **45**, 5945-5952.
- Kappelmeyer, U., Kuschik, P. and Stottmeister, U. (2003) Model experiments on the influence of artificial humic compounds on chemodenitrification. *Water Air Soil Pollut.* **147**, 317-330.

- Kesik, M., Ambus, P., Baritz, R., Brüggemann, N., Butterbach-Bahl, K., Damm, M., Duyzer, J., Horvath, L., Kiese, R., Kitzler, B., Leip, A., Li, C., Pihlatie, M., Pilegaard, K., Seufert, G., Simpson, D., Skiba, U., Smiatek, G., Vesala, T. and Zechmeister-Boltenstern, S. (2005) Inventories of N₂O and NO emissions from European forest soils. *Biogeosciences* **2**, 353-375.
- Kesik, M., Blagodatsky, S., Papen, H. and Butterbach-Bahl, K. (2006) Effect of pH, temperature and substrate on N₂O, NO and CO₂ production by *Alcaligenes faecalis* p. *J. Appl. Microbiol.* **101**, 655-667.
- Kondratenko, E.V. and Pérez-Ramírez, J. (2006) Mechanism and kinetics of direct N₂O decomposition over Fe–MFI zeolites with different iron speciation from temporal analysis of products. *J. Phys. Chem. B* **110**, 22586-22595.
- Kool, D.M., Dolfing, J., Wrage, N. and Van Groenigen, J.W. (2011) Nitrifier denitrification as a distinct and significant source of nitrous oxide from soil. *Soil Biol. Biochem.* **43**, 174-178.
- Kool, D.M., Müller, C., Wrage, N., Oenema, O. and Van Groenigen, J.W. (2009a) Oxygen exchange between nitrogen oxides and H₂O can occur during nitrifier pathways. *Soil Biol. Biochem.* **41**, 1632-1641.
- Kool, D.M., Wrage, N., Oenema, O., Harris, D. and Van Groenigen, J.W. (2009b) The ¹⁸O signature of biogenic nitrous oxide is determined by O exchange with water. *Rapid Commun. Mass Spectrom.* **23**, 104-108.
- Köster, J.R., Well, R., Tuzson, B., Bol, R., Dittert, K., Giesemann, A., Emmenegger, L., Manninen, A., Cárdenas, L. and Mohn, J. (2013) Novel laser spectroscopic technique for continuous analysis of N₂O isotopomers – application and intercomparison with isotope ratio mass spectrometry. *Rapid Commun. Mass Spectrom.* **27**, 216-222.
- Kuenen, J.G. and Robertson, L.A. (1994) Combined nitrification-denitrification processes. *FEMS microbiol rev* **15**, 109-117.
- Laudelout, H., Germain, L., Chabalier, P.F. and Chiang, C.N. (1977) Computer simulation of loss of fertilizer nitrogen through chemical decomposition of nitrite. *J. Soil Sci.* **28**, 329-339.
- Laughlin, R.J. and Stevens, R.J. (2002) Evidence for fungal dominance of denitrification and codenitrification in a grassland soil. *Soil Sci. Soc. Am. J.* **66**, 1540-1548.
- Lebedeva, E.V., Alawi, M., Fiencke, C., Namsaraev, B., Bock, E. and Spieck, E. (2005) Moderately thermophilic nitrifying bacteria from a hot spring of the Baikal rift zone. *FEMS Microbiol Ecol* **54**, 297-306.
- Leininger, S., Urich, T., Schloter, M., Schwark, L., Qi, J., Nicol, G.W., Prosser, J.I., Schuster, S.C. and Schleper, C. (2006) Archaea predominate among ammonia-oxidizing prokaryotes in soils. *Nature* **442**, 806-809.
- Lewicka-Szczebak, D., Well, R., Bol, R., Gregory, A.S., Matthews, G.P., Misselbrook, T., Whalley, W.R. and Cardenas, L.M. (2015) Isotope fractionation factors controlling isotopocule

- signatures of soil-emitted N₂O produced by denitrification processes of various rates. *Rapid Commun. Mass Spectrom.* **29**, 269-282.
- Li, C., Aber, J., Stange, F., Butterbach-Bahl, K. and Papen, H. (2000) A process-oriented model of N₂O and NO emissions from forest soils: 1. Model development. *J. Geophys. Res.* **105**, 4369-4384.
- Liu, S., Vereecken, H. and Brüggemann, N. (2014) A highly sensitive method for the determination of hydroxylamine in soils. *Geoderma* **232–234**, 117-122.
- Magill, A.H., Aber, J.D., Berntson, G.M., McDowell, W.H., Nadelhoffer, K.J., Melillo, J.M. and Steudler, P. (2000) Long-term nitrogen additions and nitrogen saturation in two temperate forests. *Ecosystems* **3**, 238-253.
- Marschner, H., Römheld, V., Horst, W.J. and Martin, P. (1986) Root-induced changes in the rhizosphere: Importance for the mineral nutrition of plants. *Z. Pflanzenernaehr. Bodenk.* **149**, 441-456.
- Matthias, A.D., Blackmer, A.M. and Bremner, J.M. (1979) Diurnal variability in the concentration of nitrous oxide in surface air. *Geophys. Res. Lett.* **6**, 441-443.
- Meyer, V. (1875) Ueber die Nitroverbindungen der Fettreihe. *Liebigs Ann. Chem.* **175**, 88-140.
- Minami, K. and Fukushi, S. (1986) Emission of nitrous oxide from a well-aerated andosol treated with nitrite and hydroxylamine. *Soil Sci. Plant Nutr.* **32**, 233-237.
- Moews, P.C.J. and Audrieth, L.F. (1959) The autoxidation of hydroxylamine. *J. Inorg. Nucl. Chem.* **11**, 242-246.
- Mohn, J., Guggenheim, C., Tuzson, B., Vollmer, M.K., Toyoda, S., Yoshida, N. and Emmenegger, L. (2010) A liquid nitrogen-free preconcentration unit for measurements of ambient N₂O isotopomers by QCLAS. *Atmos. Meas. Tech.* **3**, 609-618.
- Mohn, J., Tuzson, B., Manninen, A., Yoshida, N., Toyoda, S., Brand, W.A. and Emmenegger, L. (2012) Site selective real-time measurements of atmospheric N₂O isotopomers by laser spectroscopy. *Atmos. Meas. Tech.* **5**, 1601-1609.
- Mohn, J., Wolf, B., Toyoda, S., Lin, C.-T., Liang, M.-C., Brüggemann, N., Wissel, H., Steiker, A.E., Dyckmans, J., Szwec, L., Ostrom, N.E., Casciotti, K.L., Forbes, M., Giesemann, A., Well, R., Doucett, R.R., Yarnes, C.T., Ridley, A.R., Kaiser, J. and Yoshida, N. (2014) Interlaboratory assessment of nitrous oxide isotopomer analysis by isotope ratio mass spectrometry and laser spectroscopy: current status and perspectives. *Rapid Commun. Mass Spectrom.* **28**, 1995-2007.
- Moir, J.W.B., Crossman, L.C., Spiro, S. and Richardson, D.J. (1996) The purification of ammonia monooxygenase from *Paracoccus denitrificans*. *FEBS Lett* **387**, 71-74.
- Monaghan, R.M. and Barraclough, D. (1992) Some chemical and physical factors affecting the rate and dynamics of nitrification in urine-affected soil. *Plant Soil* **143**, 11-18.
- Montzka, S.A., Dlugokencky, E.J. and Butler, J.H. (2011) Non-CO₂ greenhouse gases and climate change. *Nature* **476**, 43-50.

- Moraghan, J.T. and Buresh, R.J. (1977) Chemical reduction of nitrite and nitrous oxide by ferrous iron. *Soil Sci. Soc. Am. J.* **41**, 47-50.
- Mørkved, P.T., Dörsch, P. and Bakken, L.R. (2007) The N₂O product ratio of nitrification and its dependence on long-term changes in soil pH. *Soil Biol. Biochem.* **39**, 2048-2057.
- Müller, C., Laughlin, R.J., Spott, O. and Rütting, T. (2014) Quantification of N₂O emission pathways via a ¹⁵N tracing model. *Soil Biol. Biochem.* **72**, 44-54.
- Mulvaney, R.L., Khan, S.A. and Mulvaney, C.S. (1997) Nitrogen fertilizers promote denitrification. *Biol. Fert. Soils* **24**, 211-220.
- Mummey, D.L., Smith, J.L. and Bolton, H. (1994) Nitrous oxide flux from a shrub-steppe ecosystem: Sources and regulation. *Soil Biol. Biochem.* **26**, 279-286.
- Nägele, W. and Conrad, R. (1990) Influence of soil pH on the nitrate-reducing microbial populations and their potential to reduce nitrate to NO and N₂O. *FEMS Microbiol. Ecol.* **74**, 49-57.
- Nejidat, A. (2005) Nitrification and occurrence of salt-tolerant nitrifying bacteria in the Negev desert soils. *FEMS Microbiol. Ecol.* **52**, 21-29.
- Nelson, D.W. (1978) Transformations of hydroxylamine in soils. *Proc. Indiana Acad. Sci.* **87**, 409-413.
- Nelson, D.W. (1982) Gaseous losses of nitrogen other than through denitrification. In *Nitrogen in agricultural soils* (ed. Stevenson, F.J.). American Society of Agronomy, Madison. pp. 327-363.
- Nelson, D.W. and Bremner, J.M. (1969) Factors affecting chemical transformations of nitrite in soils. *Soil Biol. Biochem.* **1**, 229-239.
- Nelson, D.W. and Bremner, J.M. (1970a) Gaseous products of nitrite decomposition in soils. *Soil Biol. Biochem.* **2**, 203-215.
- Nelson, D.W. and Bremner, J.M. (1970b) Role of soil minerals and metallic cations in nitrite decomposition and chemodenitrification in soils. *Soil Biol. Biochem.* **2**, 1-8.
- Nicol, G.W., Leininger, S., Schleper, C. and Prosser, J.I. (2008) The influence of soil pH on the diversity, abundance and transcriptional activity of ammonia oxidizing archaea and bacteria. *Environ. Microbiol.* **10**, 2966-2978.
- Opdyke, M.R., Ostrom, N.E. and Ostrom, P.H. (2009) Evidence for the predominance of denitrification as a source of N₂O in temperate agricultural soils based on isotopologue measurements. *Global Biogeochem. Cycles* **23**, GB4018.
- Ostrom, N.E. and Ostrom, P.H. (2011) The isotopomers of nitrous oxide: analytical considerations and application to resolution of microbial production pathways. In *Handbook of Environmental Isotope Geochemistry* (ed. Baskaran, M.). Springer, Berlin & Heidelberg. pp. 453-476.
- Oswald, R., Behrendt, T., Ermel, M., Wu, D., Su, H., Cheng, Y., Breuninger, C., Moravek, A., Mougou, E., Delon, C., Loubet, B., Pommerening-Röser, A., Sörgel, M., Pöschl, U., Hoffmann,

- T., Andreae, M.O., Meixner, F.X. and Trebs, I. (2013) HONO emissions from soil bacteria as a major source of atmospheric reactive nitrogen. *Science* **341**, 1233-1235.
- Ottley, C.J., Davison, W. and Edmunds, W.M. (1997) Chemical catalysis of nitrate reduction by iron(II). *Geochim. Cosmochim. Acta* **61**, 1819-1828.
- Parkes, S.D., Jolley, D.F. and Wilson, S.R. (2007) Inorganic nitrogen transformations in the treatment of landfill leachate with a high ammonium load: A case study. *Environ. Monit. Assess.* **124**, 51-61.
- Peters, B., Casciotti, K.L., Samarkin, V.A., Madigan, M.T., Schutte, C.A. and Joye, S.B. (2014) Stable isotope analyses of NO₂⁻, NO₃⁻, and N₂O in the hypersaline ponds and soils of the McMurdo Dry Valleys, Antarctica. **135**, 87-101.
- Pierotti, D., Rasmussen, L.E. and Rasmussen, R.A. (1978) Sahara as a Possible Sink for Trace Gases. *Geophys Res Lett* **5**, 1001-1004.
- Pires, M., Rossi, M.J. and Ross, D.S. (1994) Kinetic and mechanistic aspects of the NO oxidation by O₂ in aqueous phase. *Int. J. Chem. Kinet.* **26**, 1207-1227.
- Porter, L.K. (1969) Gaseous products produced by anaerobic reaction of sodium nitrite with oxime compounds and oximes synthesized from organic matter. *Soil Sci Soc Am Pro* **33**, 696-702.
- Postma, D. (1990) Kinetics of nitrate reduction by detrital Fe(II)-silicates. *Geochim. Cosmochim. Acta* **54**, 903-908.
- Poth, M. (1986) Dinitrogen production from nitrite by a *Nitrosomonas* isolate. *Appl. Environ. Microb.* **52**, 957-959.
- Poth, M. and Focht, D.D. (1985) ¹⁵N kinetic analysis of N₂O production by *Nitrosomonas europaea*: an examination of nitrifier denitrification. *Appl. Environ. Microbiol.* **49**, 1134-1141.
- Ravishankara, A.R., Daniel, J.S. and Portmann, R.W. (2009) Nitrous oxide (N₂O): The dominant ozone-depleting substance emitted in the 21st century. *Science* **326**, 123-125.
- Rebber, R.E. and Ausloos, P. (1978) Decomposition of N₂O over Particulate Matter. *Geophys Res Lett* **5**, 761-764.
- Ritchie, G.A.F. and Nicholas, D.J. (1972) Identification of sources of nitrous oxide produced by oxidative and reductive processes in *Nitrosomonas europaea*. *Biochem. J.* **126**, 1181-1191.
- Robertson, G.P. and Groffman, P.M. (2007) Nitrogen Transformations. In *Soil Microbiology, Ecology, and Biochemistry*, 3rd ed (ed. Paul, E.A.). Elsevier, Amsterdam. pp. 341-364.
- Rohe, L., Anderson, T.-H., Braker, G., Flessa, H., Giesemann, A., Lewicka-Szczebak, D., Wrage-Mönnig, N. and Well, R. (2014) Dual isotope and isotopomer signatures of nitrous oxide from fungal denitrification – a pure culture study. *Rapid Commun. Mass Spectrom.* **28**, 1893-1903.
- Rubasinghe, G.R.G., Spak, S.N., Stanier, C.O., Carmichael, G.R. and Grassian, V.H. (2011) Abiotic mechanism for the formation of atmospheric nitrous oxide from ammonium nitrate. *Environ. Sci. Technol.* **45**, 2691-2697.

- Samarkin, V.A., Madigan, M.T., Bowles, M.W., Casciotti, K.L., Priscu, J.C., McKay, C.P. and Joye, S.B. (2010) Abiotic nitrous oxide emission from the hypersaline Don Juan Pond in Antarctica. *Nat. Geosci.* **3**, 341-344.
- Santoro, A.E., Buchwald, C., McIlvin, M.R. and Casciotti, K.L. (2011) Isotopic signature of N₂O produced by marine ammonia-oxidizing archaea. *Science* **333**, 1282-1285.
- Schmidt, B.H.M. and Matzner, E. (2009) Abiotic reaction of nitrite with dissolved organic carbon? Testing the Ferrous Wheel Hypothesis. *Biogeochemistry* **93**, 291-296.
- Schmidt, H.-L., Werner, R.A., Yoshida, N. and Well, R. (2004a) Is the isotopic composition of nitrous oxide an indicator for its origin from nitrification or denitrification? A theoretical approach from referred data and microbiological and enzyme kinetic aspects. *Rapid Commun. Mass Spectrom.* **18**, 2036-2040.
- Schmidt, I., van Spanning, R.J.M. and Jetten, M.S.M. (2004b) Denitrification and ammonia oxidation by *Nitrosomonas europaea* wild-type, and NirK- and NorB-deficient mutants. *Microbiology* **150**, 4107-4114.
- Schütz, K., Junge, C., Beck, R. and Albrecht, B. (1970) Studies of Atmospheric N₂O. *J Geophys Res* **75**, 2230-2246.
- Serça, D., Delmas, R., Jambert, C. and Labroue, L. (1994) Emissions of nitrogen oxides from equatorial rain forest in central Africa: origin and regulation of NO emission from soils. *Tellus B* **46**, 243-254.
- Shen, Q.R., Ran, W. and Cao, Z.H. (2003) Mechanisms of nitrite accumulation occurring in soil nitrification. *Chemosphere* **50**, 747-753.
- Smith, C.J. and Chalk, P.M. (1980) Gaseous nitrogen evolution during nitrification of ammonia fertilizer and nitrite transformations in soils. *Soil Sci. Soc. Am. J.* **44**, 277-282.
- Smith, P., Martino, D., Cai, Z., Gwary, D., Janzen, H., Kumar, P., McCarl, B., Ogle, S., O'Mara, F., Rice, C., Scholes, B. and Sirotenko, O. (2007) Agriculture. In: *Climate Change 2007: Mitigation. Contribution of Working Group III to the Fourth Assessment Report of the Intergovernmental Panel on Climate Change* (eds. Metz, B., Davidson, O., Bosch, P., Dave, R. and Meyer, L.), Cambridge & New York. pp. 497-540.
- Smith, R.V., Doyle, R.M., Burns, L.C. and Stevens, R.J. (1997) A model for nitrite accumulation in soils. *Soil Biol. Biochem.* **29**, 1241-1247.
- Sørensen, J. and Thorling, L. (1991) Stimulation by lepidocrocite (γ -FeOOH) of Fe(II)-dependent nitrite reduction. *Geochim. Cosmochim. Acta* **55**, 1289-1294.
- Spott, O., Russow, R. and Stange, C.F. (2011) Formation of hybrid N₂O and hybrid N₂ due to codenitrification: First review of a barely considered process of microbially mediated N-nitrosation. *Soil Biol. Biochem.* **43**, 1995-2011.
- Spott, O. and Stange, C.F. (2011) Formation of hybrid N₂O in a suspended soil due to codenitrification of NH₂OH. *J. Plant Nutr. Soil Sci.* **174**, 554-567.

- Stange, F., Butterbach Bahl, K., Papen, H., Zechmeister Boltensern, S., Li, C.S. and Aber, J. (2000) A process-oriented model of N₂O and NO emissions from forest soils 2. Sensitivity analysis and validation. *J. Geophys. Res.* **105**, 4385-4398.
- Stevens, R.J. and Laughlin, R.J. (1994) Determining nitrogen-15 in nitrite or nitrate by producing nitrous oxide. *Soil Sci. Soc. Am. J.* **58**, 1108-1116.
- Stevens, R.J., Laughlin, R.J., Burns, L.C., Arah, J.R.M. and Hood, R.C. (1997) Measuring the contributions of nitrification and denitrification to the flux of nitrous oxide from soil. *Soil Biol. Biochem.* **29**, 139-151.
- Stevens, R.J., Laughlin, R.J. and Malone, J.P. (1998) Soil pH affects the processes reducing nitrate to nitrous oxide and di-nitrogen. *Soil Biol. Biochem.* **30**, 1119-1126.
- Stevenson, F.J., Harrison, R.M., Wetselaar, R. and Leeper, R.A. (1970) Nitrosation of soil organic matter: 3. Nature of gases produced by reaction of nitrite with lignins, humic substances, and phenolic constituents under neutral and slightly acidic conditions. *Soil Sci. Soc. Am. Proc.* **34**, 430-435.
- Stüven, R., Vollmer, M. and Bock, E. (1992) The impact of organic matter on nitric oxide formation by *Nitrosomonas europaea*. *Arch. Microbiol.* **158**, 439-443.
- Su, H., Cheng, Y., Oswald, R., Behrendt, T., Trebs, I., Meixner, F.X., Andreae, M.O., Cheng, P., Zhang, Y. and Pöschl, U. (2011) Soil nitrite as a source of atmospheric HONO and OH radicals. *Science* **333**, 1616-1618.
- Sutka, R.L., Adams, G.C., Ostrom, N.E. and Ostrom, P.H. (2008) Isotopologue fractionation during N₂O production by fungal denitrification. *Rapid Commun. Mass Spectrom.* **22**, 3989-3996.
- Sutka, R.L., Ostrom, N.E., Ostrom, P.H., Breznak, J.A., Gandhi, H., Pitt, A.J. and Li, F. (2006) Distinguishing nitrous oxide production from nitrification and denitrification on the basis of isotopomer abundances. *Appl. Environ. Microbiol.* **72**, 638-644.
- Sutka, R.L., Ostrom, N.E., Ostrom, P.H., Gandhi, H. and Breznak, J.A. (2003) Nitrogen isotopomer site preference of N₂O produced by *Nitrosomonas europaea* and *Methylococcus capsulatus* Bath. *Rapid Commun. Mass Spectrom.* **17**, 738-745.
- Sutka, R.L., Ostrom, N.E., Ostrom, P.H., Gandhi, H. and Breznak, J.A. (2004) Nitrogen isotopomer site preference of N₂O produced by *Nitrosomonas europaea* and *Methylococcus capsulatus* Bath. *Rapid Commun. Mass Spectrom.* **18**, 1411-1412.
- Tai, Y.L. and Dempsey, B.A. (2009) Nitrite reduction with hydrous ferric oxide and Fe(II): Stoichiometry, rate, and mechanism. *Water Res.* **43**, 546-552.
- Tappe, W., Laverman, A., Bohland, M., Braster, M., Rittershaus, S., Groeneweg, J. and van Verseveld, H.W. (1999) Maintenance energy demand and starvation recovery dynamics of *Nitrosomonas europaea* and *Nitrobacter winogradskyi* cultivated in a retentostat with complete biomass retention. *Appl. Environ. Microb.* **65**, 2471-2477.

- Thorn, K.A. and Mikita, M.A. (2000) Nitrite fixation by humic substances: Nitrogen-15 nuclear magnetic resonance evidence for potential intermediates in chemodenitrification. *Soil Sci. Soc. Am. J.* **64**, 568-582.
- Toyoda, S., Mutoke, H., Yamagishi, H., Yoshida, N. and Tanji, Y. (2005) Fractionation of N₂O isotopomers during production by denitrifier. *Soil Biol. Biochem.* **37**, 1535-1545.
- Toyoda, S. and Yoshida, N. (1999) Determination of nitrogen isotopomers of nitrous oxide on a modified isotope ratio mass spectrometer. *Anal. Chem.* **71**, 4711-4718.
- Toyoda, S., Yoshida, N., Miwa, T., Matsui, Y., Yamagishi, H., Tsunogai, U., Nojiri, Y. and Tsurushima, N. (2002) Production mechanism and global budget of N₂O inferred from its isotopomers in the western North Pacific. *Geophys. Res. Lett.* **29**, 1037-1340.
- Tuzson, B., Zeyer, K., Steinbacher, M., McManus, J.B., Nelson, D.D., Zahniser, M.S. and Emmenegger, L. (2013) Selective measurements of NO, NO₂ and NO_y in the free troposphere using quantum cascade laser spectroscopy. *Atmos. Meas. Tech.* **6**, 927-936.
- Udert, K.M., Larsen, T.A. and Gujer, W. (2005) Chemical nitrite oxidation in acid solutions as a consequence of microbial ammonium oxidation. *Environ. Sci. Technol.* **39**, 4066-4075.
- USEPA (2010) Methane and nitrous oxide emissions from natural sources. (eds. Anderson, B., Bartlett, K., Frolking, S., Hayhoe, K., Jenkins, J. and Salas, W.). United States Environmental Protection Agency, Washington DC.
- Valentine, D.L. (2007) Adaptations to energy stress dictate the ecology and evolution of the Archaea. *Nat Rev Micro* **5**, 316-323.
- van Cleemput, O. (1998) Subsoils: chemo- and biological denitrification, N₂O and N₂ emissions. *Nutr. Cycl. Agroecosys.* **52**, 187-194.
- van Cleemput, O. and Baert, L. (1978) Calculations of the nitrite decomposition reactions in soils. In *Environmental biogeochemistry and geomicrobiology* (ed. Krumbein, W.E.). Ann Arbor Science Press, Ann Arbor. pp. 591-600.
- van Cleemput, O. and Baert, L. (1983) Nitrite stability influenced by iron compounds. *Soil Biol. Biochem.* **15**, 137-140.
- van Cleemput, O. and Baert, L. (1984) Nitrite - a key compound in N-loss processes under acid conditions? *Plant Soil* **76**, 233-241.
- van Cleemput, O. and Samater, A.H. (1996) Nitrite in soils: Accumulation and role in the formation of gaseous N compounds. *Fertil. Res.* **45**, 81-89.
- van der Star, W.R.L., van de Graaf, M.J., Kartal, B., Picioreanu, C., Jetten, M.S.M. and van Loosdrecht, M.C.M. (2008) Response of Anaerobic Ammonium-Oxidizing Bacteria to Hydroxylamine. *Appl. Environ. Microbiol.* **74**, 4417-4426.
- Venterea, R.T. (2007) Nitrite-driven nitrous oxide production under aerobic soil conditions: kinetics and biochemical controls. *Glob. Change Biol.* **13**, 1798-1809.

- Venterea, R.T., Dolan, M.S. and Ochsner, T.E. (2010) Urea decreases nitrous oxide emissions compared with anhydrous ammonia in a Minnesota corn cropping system. *Soil Sci. Soc. Am. J.* **74**, 407-418.
- Venterea, R.T., Groffman, P.M., Verchot, L.V., Magill, A.H., Aber, J.D. and Steudler, P.A. (2003) Nitrogen oxide gas emissions from temperate forest soils receiving long-term nitrogen inputs. *Glob. Change Biol.* **9**, 346-357.
- Venterea, R.T. and Rolston, D.E. (2000a) Mechanisms and kinetics of nitric and nitrous oxide production during nitrification in agricultural soil. *Glob. Change Biol.* **6**, 303-316.
- Venterea, R.T. and Rolston, D.E. (2000b) Nitric and nitrous oxide emissions following fertilizer application to agricultural soil: Biotic and abiotic mechanisms and kinetics. *J. Geophys. Res.* **105**, 15117-15129.
- Venterea, R.T., Rolston, D.E. and Cardon, Z.G. (2005) Effects of soil moisture, physical, and chemical characteristics on abiotic nitric oxide production. *Nutr. Cycl. Agroecosys.* **72**, 27-40.
- Waechter, H., Mohn, J., Tuzson, B., Emmenegger, L. and Sigrist, M.W. (2008) Determination of N₂O isotopomers with quantum cascade laser based absorption spectroscopy. *Opt. Express* **16**, 9239-9244.
- Well, R. and Flessa, H. (2009) Isotopologue enrichment factors of N₂O reduction in soils. *Rapid Commun. Mass Spectrom.* **23**, 2996-3002.
- Well, R., Flessa, H., Xing, L., Ju, X.T. and Romheld, V. (2008) Isotopologue ratios of N₂O emitted from microcosms with NH₄⁺ fertilized arable soils under conditions favoring nitrification. *Soil Biol. Biochem.* **40**, 2416-2426.
- Well, R., Kurganova, I., Lopes de Gerenyu, V. and Flessa, H. (2006) Isotopomer signatures of soil-emitted N₂O under different moisture conditions—A microcosm study with arable loess soil. *Soil Biol. Biochem.* **38**, 2923-2933.
- WMO (2013) WMO Greenhouse Gas Bulletin No. 9. World Meteorological Organization, Geneva. pp. 1-4.
- Wrage, N., van Groenigen, J.W., Oenema, O. and Baggs, E.M. (2005) A novel dual-isotope labelling method for distinguishing between soil sources of N₂O. *Rapid Commun. Mass Spectrom.* **19**, 3298-3306.
- Wrage, N., Velthof, G.L., van Beusichem, M.L. and Oenema, O. (2001) Role of nitrifier denitrification in the production of nitrous oxide. *Soil Biol. Biochem.* **33**, 1723-1732.
- Wuebbles, D.J. (2009) Nitrous oxide: No laughing matter. *Science* **326**, 56-57.
- Wullstein, L.H. and Gilmour, C.M. (1964) Non-enzymatic gaseous loss of nitrite from clay and soil systems. *Soil Sci.* **97**, 428-430.
- Wullstein, L.H. and Gilmour, C.M. (1966) Non-enzymatic formation of nitrogen gas. *Nature* **210**, 1150-1151.

- Wunderlin, P., Lehmann, M.F., Siegrist, H., Tuzson, B., Joss, A., Emmenegger, L. and Mohn, J. (2013) Isotope signatures of N₂O in a mixed microbial population system: constraints on N₂O producing pathways in wastewater treatment. *Environ. Sci. Technol.* **47**, 1339-1348.
- Wunderlin, P., Mohn, J., Joss, A., Emmenegger, L. and Siegrist, H. (2012) Mechanisms of N₂O production in biological wastewater treatment under nitrifying and denitrifying conditions. *Water Res.* **46**, 1027-1037.
- Yamashita, T. and Vannice, A. (1996) N₂O Decomposition over Manganese Oxides. **161**, 254-262.
- Yamulki, S., Harrison, R.M., Goulding, K.W.T. and Webster, C.P. (1997) N₂O, NO and NO₂ fluxes from a grassland: Effect of soil pH. *Soil Biol. Biochem.* **29**, 1199-1208.
- Yang, W.H., Weber, K.A. and Silver, W.L. (2012) Nitrogen loss from soil through anaerobic ammonium oxidation coupled to iron reduction. *Nature Geosci.* **5**, 538-541.
- Yoshida, N. and Toyoda, S. (2000) Constraining the atmospheric N₂O budget from intramolecular site preference in N₂O isotopomers. *Nature* **405**, 330-334.
- Yu, R., Kampschreur, M.J., Loosdrecht, M.C.M.v. and Chandran, K. (2010) Mechanisms and specific directionality of autotrophic nitrous oxide and nitric oxide generation during transient anoxia. *Environ. Sci. Technol.* **44**, 1313-1319.
- Zhang, J., Cai, Z. and Zhu, T. (2011) N₂O production pathways in the subtropical acid forest soils in China. *Environ. Res.* **111**, 643-649.
- Zhu, T.B., Zhang, J.B. and Cai, Z.C. (2011) The contribution of nitrogen transformation processes to total N₂O emissions from soils used for intensive vegetable cultivation. *Plant Soil* **343**, 313-327.