

Generation and Applications of Knowledge Graphs in Systems and Networks Biology

Kumulative Dissertation

zur Erlangung des Doktorgrades (Dr. rer. nat.)
der Mathematisch-Naturwissenschaftlichen Fakultät
der Rheinischen Friedrich-Wilhelms-Universität Bonn

vorgelegt von

CHARLES TAPLEY HOYT

aus New Haven, Connecticut, United States of America

Bonn, 2019

Angefertigt mit Genehmigung
der Mathematisch-Naturwissenschaftlichen Fakultät
der Rheinischen Friedrich-Wilhelms-Universität Bonn

1. Gutachter: Univ.-Prof. Dr. rer. nat. Martin Hofmann-Apitius
2. Gutachter: Univ.-Prof. Dr. rer. nat. Andreas Weber

Tag der Promotion: 3. Dezember 2019
Erscheinungsjahr: 2019

Abstract

The acceleration in the generation of data in the biomedical domain has necessitated the use of computational approaches to assist in its interpretation. However, these approaches rely on the availability of high quality, structured, formalized biomedical knowledge.

This thesis has the two goals to improve methods for curation and semantic data integration to generate high granularity biological knowledge graphs and to develop novel methods for using prior biological knowledge to propose new biological hypotheses.

The first two publications describe an ecosystem for handling biological knowledge graphs encoded in the Biological Expression Language throughout the stages of curation, visualization, and analysis. Further, the second two publications describe the reproducible acquisition and integration of high-granularity knowledge with low contextual specificity from structured biological data sources on a massive scale and support the semi-automated curation of new content at high speed and precision.

After building the ecosystem and acquiring content, the last three publications in this thesis demonstrate three different applications of biological knowledge graphs in modeling and simulation. The first demonstrates the use of agent-based modeling for simulation of neurodegenerative disease biomarker trajectories using biological knowledge graphs as priors. The second applies network representation learning to prioritize nodes in biological knowledge graphs based on corresponding experimental measurements to identify novel targets. Finally, the third uses biological knowledge graphs and develops algorithmics to deconvolute the mechanism of action of drugs, that could also serve to identify drug repositioning candidates.

Ultimately, this thesis lays the groundwork for production-level applications of drug repositioning algorithms and other knowledge-driven approaches to analyzing biomedical experiments.

Acknowledgments

I would like to thank my family, whom I've missed very much while I've been so far away.

I would like to thank my advisor, Martin Hofmann-Apitius, for enabling and supporting me throughout this experience.

I would like to thank André Gemúnd, Horst Schwichtenberg, and all of Fraunhofer SCAI.IT for the help and wisdom that they've shared.

I would like to thank all of my fellow PhDs and my students at Fraunhofer SCAI.Bio, who were a joy to work with and mentor.

I would like to thank Meike Knieps and Alina Enns for all of their organizational support.

I would like to thank Scott Colby, who was always there for me even during his own graduate schooling.

Most importantly, I would like to thank Daniel Domingo-Fernández, who was my teammate through all of this and a good friend. It's been a pleasure working with you.

Also, a shout out to people who read bits of this thesis and gave feedback: Sarah Mubeen, Luke Chvisuk, and Mike Perrone.

Publications

Thesis Publications

1. **Hoyt, C. T.**, Konotopez, A., & Ebeling, C. (2017). PyBEL: a computational framework for Biological Expression Language. *Bioinformatics (Oxford, England)*, 34(4), 703–704.
2. **Hoyt, C. T.**, Domingo-Fernández, D., & Hofmann-Apitius, M. (2018). BEL Commons: an environment for exploration and analysis of networks encoded in Biological Expression Language. *Database*, 2018(3), 1–11.
3. **Hoyt, C. T.**, *et al.* (2019). Re-curation and rational enrichment of knowledge graphs in Biological Expression Language. *Database*, 2019, baz068.
4. **Hoyt, C. T.**, *et al.* (2019). Bio2BEL: Integration of Structured Knowledge Sources with Biological Expression Language. *BMC Bioinformatics*, submitted.
5. Gündel, M., **Hoyt, C. T.**, & Hofmann-Apitius, M. (2018). BEL2ABM: Agent-based simulation of static models in Biological Expression Language. *Bioinformatics*, 34(13), 2316–2318.
6. Muslu, Ö., **Hoyt, C. T.**, Hofmann-Apitius, M., & Fröhlich, H. (2019). Guilty-Targets: Prioritization of Novel Therapeutic Targets with Deep Network Representation Learning. *IEEE/ACM Trans. Comput. Biol. Bioinform.*, submitted.
7. **Hoyt, C. T.**, *et al.* (2018). A systematic approach for identifying shared mechanisms in epilepsy and its comorbidities. *Database*, 2018(1).

Other Publications

8. Bradford, R., Sturm, T., Weber, A., Davenport, J. H., England, M., Errami, H., Gerdt, V., Grigoriev, D., **Hoyt, C. T.**, Košta, M., & Radulescu, O. (2017). A Case Study on the Parametric Occurrence of Multiple Steady States. In Proceedings of the 2017 ACM on International Symposium on Symbolic and Algebraic Computation - ISSAC '17 (Vol. Part F1293, pp. 45–52). New York, New York, USA: ACM Press.
9. Domingo-Fernández, D., **Hoyt, C. T.**, Alvarez, C. B., Marin-Llao, J., & Hofmann-Apitius, M. (2018). ComPath: an ecosystem for exploring, analyzing, and curating mappings across pathway databases. *Npj Systems Biology and Applications*, 5(1), 3.
10. Domingo-Fernández, D., Mubeen, S., Marín-Llaó, J., **Hoyt, C. T.**, & Hofmann-Apitius, M. (2019). PathMe: merging and exploring mechanistic pathway knowledge. *BMC Bioinformatics*, 20(1), 243.
11. Ali, M., **Hoyt, C. T.**, Domingo-Fernández, D., Lehmann, J., & Jabeen, H. (2019). BioKEEN: A library for learning and evaluating biological knowledge graph embeddings. *Bioinformatics (Oxford, England)*.
12. Bradford, R., Davenport, J. H., England, M., Errami, H., Gerdt, V., Grigoriev, D., **Hoyt, C. T.**, Kosta, M., Radulescu, O., Sturm, T., & Weber, A. (2019). Identifying the Parametric Occurrence of Multiple Steady States for some Biological Networks. Retrieved from <http://arxiv.org/abs/1902.04882>
13. Brito, E., Georgiev, B., Domingo-Fernández, D., **Hoyt, C. T.**, & Bauckhage, C. (2019) RatVec: A General Approach for Low-dimensional Distributed Vector Representations via Domain-specific Rational Kernels. In *Proceedings of ECML PKDD*
14. Ali., M., Jabeen, H., **Hoyt, C. T.**, & Lehmann, J. (2019) The KEEN Universe: An Ecosystem for Knowledge Graph Embeddings with a Focus on Reproducibility and Transferability. In *Proceedings of ISWC*.
15. Ali., M., Domingo-Fernández, D., **Hoyt, C. T.**, & Lehmann, J. (2019) Predicting Missing Links Using PyKEEN. In *Proceedings of ISWC*.
16. Karki, K., Kodamullil, A. T., **Hoyt, C. T.**, & Hofmann-Apitius, M. (2019) Quantifying mechanisms in neurodegenerative diseases (NDDs) using candidate mechanism perturbation amplitude (CMPA) algorithm. *BMC Bioinformatics*, 20(1), 494..

17. Emon, M. A., Domingo-Fernández, D., **Hoyt, C. T.**, & Hofmann-Apitius, M. (2019) PS4DR: a multimodal workflow for identification and prioritization of drugs based on pathway signatures. *BMC Bioinformatics*, submitted.
18. Mubeen, S., **Hoyt, C. T.**, Gemünd, A., Hofmann-Apitius, M., Fröhlich, H., & Domingo-Fernández, D. (2019). The Impact of Pathway Database Choice on Statistical Enrichment Analysis and Predictive Modeling. *Frontiers in Genetics*.
19. Humayun, F., Domingo-Fernández, D., George, A. A. P., Hopp, M. T., Syllwasschy, B. F., Detzel, M. S., **Hoyt, C. T.**, Hofmann-Apitius, M., Imhof, D. (2019). A computational approach for mapping heme biology in the context of hemolytic disorders. *bioRxiv*, 804906.
20. Golriz Khatami, S., Robinson, C., Birkenbihl, C., Domingo-Fernández, D., **Hoyt, C. T.**, & Hofmann-Apitius, M. (2019;). Challenges of Integrative Disease Modeling using Neuroimaging Features. *Frontiers in Molecular Biosciences*, in review.

Contents

1	Prologue	1
2	PyBEL: a computational framework for Biological Expression Language	29
3	BEL Commons: an environment for exploration and analysis of networks encoded in Biological Expression Language	35
4	Re-curation and rational enrichment of knowledge graphs in Biological Expression Language	49
5	Integration of structured biological data sources using Biological Expression Language	65
6	BEL2ABM: agent-based simulation of static models in Biological Expression Language	83
7	GuiltyTargets: prioritization of novel therapeutic targets with deep network representation learning	89
8	A systematic approach for identifying shared mechanisms in epilepsy and its comorbidities	105
9	Epilogue	117

List of Figures

1	HGNC Gene Symbol Half Lives	7
2	Levels of Knowledge Abstraction	9
3	Descriptive Levels of OWL	10
4	The Schema of a BEL Relation	13
5	The Schema of a BEL Script	14
6	A Schematic Diagram of Reverse Causal Reasoning (RCR)	19
7	Hypothesis Network Generation for Network Perturbation Amplitude (NPA)	19
8	Decomposition of Spanning Trees	20
9	DeepWalk Embeddings Reflect Community Structure	24

List of Tables

1	Example model organism gene nomenclature databases	3
2	Example entity types of interest in the biomedical domain and corresponding nomenclature sources	4
3	Examples of affix categories in the FamPlex ontology adapted from Table 2 of [11]	4
4	Examples of qualities of biological relationships and their attributes	15
5	Examples of relation extraction and reading systems with varying degrees of domain specificity	16
6	Examples of three types of Knowledge Graph Embedding Models (sKGEMs)	21

1 Prologue

The quantity of data, information, and knowledge in the biomedical domain is increasing at an unprecedented rate — with no signs of deceleration. Even with the assistance of information retrieval technologies, it is overwhelming, if not impossible, for individuals or groups of researchers to be knowledgeable of the state of the art in any but an incredibly specific topic. Besides their obvious increases in volume and velocity, data are also increasing in variety as multi-modal and multi-scale experiments grow more important in the investigation of complex diseases.

As experiments' complexities grow, so does the intellectual and temporal burden of analysis and interpretation. Developing systematic and reproducible methods to reduce this burden first requires the formalization and assembly of knowledge in a computable form. The publications in this thesis build towards leveraging and improving previously existing methodologies for extracting, formalizing, and storing biological knowledge to support the development and application of algorithms towards unraveling the complex biology of disease and proposing new therapies.

Before presenting the publications included in this thesis, background is given on several topics present through each including the nomenclature of entities in the biomedical literature, the techniques and formalisms used for biomedical knowledge graphs, algorithms appropriate for analyzing biomedical knowledge graphs, and finally, their applications.

1.1 Nomenclature

The first two sections of the introduction examine the organization of biomedical knowledge, and several of the challenges faced during the process. These challenges span from unifying the nomenclature of biologically relevant entities used in the published biomedical literature to extracting the biological knowledge and context surrounding those entities.

1.1.1 Issues with Gene Nomenclature

The nomenclature of genes and gene products is a particularly egregious example of poor nomenclature within the biomedical domain. Genes often have several names as well as several incomprehensible acronyms, or gene symbols. For example, the HUGO Gene Nomenclature Committee (HGNC) [1] and Entrez Gene [2] database list that the human gene microtubule associated protein tau (hgnc:HGNC:6893, ncbigene:4137) has previously been named the G protein $\beta 1/\gamma 2$ subunit-interacting factor 1 and the protein phosphatase 1, regulatory subunit 103. Like with many genes, it is often acronymized to MAPT in text, but it has additionally been previously referenced with DDPAC, FLJ31424, FTDP-17, MAPTL, MGC13854, MTBT1, MTBT2, MSTD, PPND, and PPP1R103.

Neither genes' names nor their gene symbols convey their host species, which leads to further ambiguities in articles discussing orthologs in model organisms. The organization responsible for mouse gene nomenclature, Mouse Genome Informatics (MGI) [3], names the mouse orthologous gene as microtubule-associated protein tau (mgi:MGI:97180, ncbigene:17762) and lists the gene symbol as Mapt. In this example, the name varies from the human ortholog with the introduction of a hyphen between "microtubule" and "associated." The gene symbol differs only in capitalization. Similarly, the organization for rat genome nomenclature, the Rat Genome Database (RGD) [4], names the rat orthologous gene as microtubule-associated protein tau (rgd:69329; ncbigene:29477)—exactly as in MGI. While these orthologs from common model organisms have had related names, organisms with genetic drift such as Zebrafish have several orthologs named microtubule-associated protein tau a (zfin:ZDB-GENE-081027-1) and microtubule-associated protein tau b (zfin:ZDB-GENE-081027-2) whose gene symbols are listed as mapta and maptb, respectively. Other orthologs to human microtubule-associated protein tau can be found in Homologene (homologene:74962), Ensembl [5], HGNC, MGI,

Table 1: Example model organism gene nomenclature databases

Organism	Database	Reference
Human	HGNC	[1]
Vertebrae	VGNC	[1]
Mouse	MGI	[3]
Rat	RGD	[4]
Zebrafish	ZFIN	[7]
Drosophila (fly)	FlyBase	[8]
Xenopus (frog)	Xenbase	[9]
Yeast	SGD	[10]
-	Entrez Gene	[2]

PomBase, RGD, Xenbase, and Zebrafish Information Network (ZFIN). The HGNC Comparison of Orthology Predictions (HCOP) [6] aggregates these and several other sources of curated and predicted orthologies.

1.1.2 Nomenclature Consortia of Genes and Proteins

Most biologically relevant named entities have many names. For example, many genes were independently discovered and characterized in different labs and therefore named differently. As resources for exchanging genomic and protein sequences have become more ubiquitous in the last three decades since the inception of the Entrez gene database in 1991 and the HGNC in 1996, it has become easier to reduce those duplicates. However, this does not solve the problem of establishing a canonical name for each entity. As stated in the previous section, several committees and consortia have formed to standardize the nomenclature used for genes for each species (Table 1).

1.1.3 Nomenclature Consortia of Other Entities

Besides gene nomenclature, there are several other biologically relevant physical entities and higher-order processes that have the same issues in nomenclature. Further, for higher-order processes like pathways, mechanisms, and biological processes, it not only remains unclear what to name each example, but where their boundaries lie. However, deference to entities beyond genes and proteins is

Table 2: Example entity types of interest in the biomedical domain and corresponding nomenclature sources

Entity Type	Resources
Transcripts	Ensembl, miRBase
Proteins	UniProt
Protein Families	InterPro, neXtProt, FamPlex, ExPASy, Signor
Protein Complexes	Complex Portal, FamPlex, Signor, Gene Ontology
Biological Processes	Gene Ontology MeSH
Pathways	Reactome, WikiPathways, KEGG
Conditions and Phenotypes	Disease Ontology, Human Phenotype Ontology, MeSH

Table 3: Examples of affix categories in the FamPlex ontology adapted from Table 2 of [11]

Affix Category	Example
Experimental context	eGFP-{Gene name}
Protein state	phospho-{Gene name}
Inhibitor	shRNA-{Gene name}
Generic descriptor	Proto-oncogene {Gene name}
Species	mmu-{Gene name}
mRNA grounding	{Gene name} mRNA

required to fully describe complex biology. Thus, several groups have attempted to standardize and control the nomenclature of these entities (Table 2).

1.1.4 Practical Considerations in Named Entity Recognition

Besides further synonyms and morphological variations, Bachman *et al.* [11] outlined several affixes corresponding to post-translational modification state, experimental context, or other categories (Table 3).

Bachman *et al.* also considered issues with recognizing proteins, protein families, and protein complexes [11]. The biomedical literature often references multi-protein families (e.g., RAS, AKT) and multi-subunit complexes (e.g., NF-kB, AP-1) rather than their constituent proteins. For example, the protein family of phospholipase C enzymes, more commonly referenced as PLC, contains not only individual genes (e.g., PLCE1), but also subfamilies such as PLCG, which contains the genes PLCG1 and PLCG2. The NF-kB complex comprises five proteins (i.e., RELA, RELB, REL, NFKB1, and NFKB2) and poses the further challenge of how named entities

should be interpreted after recognition.

1.1.5 Automating Named Entity Recognition

In practice, automating the process of recognizing named entities has three major tasks: coreference resolution, Named Entity Recognition (NER), and entity linking.

Coreference Resolution

During the process of coreference resolution, antecedents or anaphors are identified and connected to their preceding or succeeding words or phrases. In the example "The EGFR belongs to a family of protein-tyrosine kinase receptors. It is activated by the binding of EFG.", coreference resolution identifies that the subject of the second sentence, *it*, refers to EGFR. There are several classical rule-based coreference resolution algorithms including the syntax-based Hobbs theory [12], discourse-based centering theory [13], and syntactic knowledge-based RAP algorithm [13]. However, recent improvements to coreference resolution have focused on four categories of machine learning techniques: mention-pair models [14–16], entity-mention models [17–19], mention-ranking models [20–23], and cluster-ranking models [24–26]. Recent work has focused on using recurrent neural networks with architectures such as the bi-directional long-short-term memory [27] and variants such as the bi-directional long-short-term memory conditional random field [28].

Named Entity Recognition

During the process of NER, words or phrases are identified to have domain-specific, non-trivial meaning. In the biomedical domain, NER is used to identify proteins [29–32], chemicals [28, 33, 34], diseases [28, 35], taxa [36, 37], and other entity types listed in Table 2.

Unlike the difference between machine learning models of coreference resolution with rule-based or natural language processing models, NER workflows often contain a mixture of preprocessing steps, rule-based feature generation, statistical models, machine learning models, and postprocessing steps. For example, Lee *et*

al. [38] defined six feature classes for training a disease recognition model using a conditional random field:

1. Morphological features that contained the original tokens, the corresponding stemmed tokens, and their affixes
2. Features based on their terminology of trigger words related to diseases, body parts, and human ability
3. Classical part-of-speech features.
4. Transformation of the original tokens to remove continued vowels, such as the superfluous “u” in the british spelling of tumour.
5. Features using a dictionary lookup on the merged disease vocabulary (MEDIC) [39].
6. Annotated abbreviations using BIOADI [40].

Other workflows have opted to use end-to-end machine learning following the advent of word embedding techniques such as word2vec [41] and GloVe [42] and deep learning techniques like the long-short-term memory conditional random field architecture [43]. Both variants require carefully constructed and annotated corpora such as GENIA [44] or those provided by the various BioCreative challenges (<https://biocreative.bioinformatics.udel.edu>). With machine learning techniques, the annotations become more important as they are also necessary for supervised learning.

Entity Linking

During the process of entity linking (i.e., normalization, grounding), named entities that have been recognized in the previous step (NER) are *grounded* to terms in controlled vocabularies or databases. For example, this means that the token MEK1 should be recognized as a synonym of the MAP2K1 gene and subsequently grounded with the HGNC identifier hgnc:HGNC:6840, Entrez Gene identifier ncbigene:5604, UniProt identifier uniprot:Q02750, and any other desired equivalent identifiers. Practically, mappings between equivalent terms in databases are manually curated by database maintainers and data stewards. As more of the nomenclatures, terminologies, and taxonomies useful to the bioinformatics community move towards ontological formats like the Web Ontology Language (OWL) and the Open Biomedical Ontology (OBO) standard, these mappings become more reusable. Concurrently, tools like the European Bioinformatic Institute (EBI) Ontology Lookup Service (OLS) [45] and emerging EBI Ontology Xref Service (<https://www.ebi.ac.uk/spot/oxo>) have been able to provide the com-

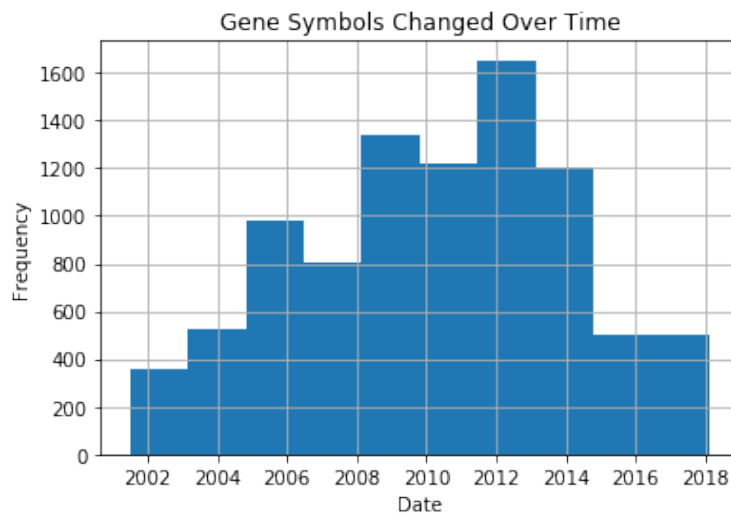

Figure 1: The frequency by which HGNC gene symbols change over time. This figure was generated with the Jupyter notebook available at [46].

munity with technical solutions for storing, indexing, and looking up information about these terms.

1.1.6 Beyond Nomenclature and Standards for Reference

The ambiguity of nomenclature in the biomedical domain presents several problems, especially as the acceleration of publication makes automated information extraction more relevant.

Anecdotally, there are few real-world data sets using HGNC gene symbols as identifiers that can be directly and fully mapped to HGNC entries. This is because the gene symbols listed by HGNC are notoriously unstable—hundreds or thousands change per year (Figure 1). These changes might be due to the splitting of a single gene entry into a family of entries, the merging of disparate genes that were the same, or deprecation of previous nomenclature. Further, Figure 1 provides an underestimate of the impact of this issue due to the fact that the HGNC only lists the most recent date of change for each gene symbol.

The Minimal Information Required In the Annotation of Models (MIRIAM) [47] standard was proposed in order to standardize the way named biological entities are referenced in models and databases in order to address the issues with repro-

ducibility arising from the previously described phenomena in natural language as part of the Minimum Information for Biological and Biomedical Investigations [48]. At its core, MIRIAM posits that instead of imprecise names, the bioinformatics community should shift towards using identifiers with five properties: unique (i.e., never assigned to two different entities), perennial (i.e., never changes and is permanent), standards compliant (i.e. conform to standards like Universal Resource Identifier (URI), Compact URI (CURIE), etc.), free to use, and resolvable (i.e., can be transformed into locations of appropriate online resources). Note that in the previous section, identifiers were written using the CURIE style (e.g., an identifier prefixed with a namespace). Curiously, the HGNC identifier includes a redundant mention of the namespace within the identifier. Further standardization of redundant CURIEs is discussed in Chapter 5.

As Figure 1 suggests, HGNC gene symbols are not perennial and are not MIRIAM compliant. However, even a decade after the proposal of MIRIAM, many databases have not yet shifted away from storing and annotating data with HGNC gene symbols to using more stable HGNC identifiers.

Unfortunately, there has been few or no concerted efforts from authors and publishers to better annotate articles with identifiers for named entities. Thus, NER and entity linking remain relevant as ever, especially due to the increasing volume of literature describing increasingly complex biology across many scales.

1.2 Formalization of Knowledge

The most abstract level of knowledge, methodological knowledge, describes the formalisms through which knowledge can be represented. The two most common schemata for methodological knowledge are Resource Description Format Schema (RDFS) and OWL. They provide the faculty to describe the middle level, conceptual knowledge, which encodes the classes, relations, and constraints relevant to a given domain. The most common conceptual knowledge formats in the biomedical domain are Biological Pathway Exchange Language (BioPAX), Systems Biology Markup Language (SBML), and Biological Expression Language (BEL). The most concrete level is factual knowledge, which consists of instances of these classes and relationships [49]. These abstractions are illustrated in Figure 2.

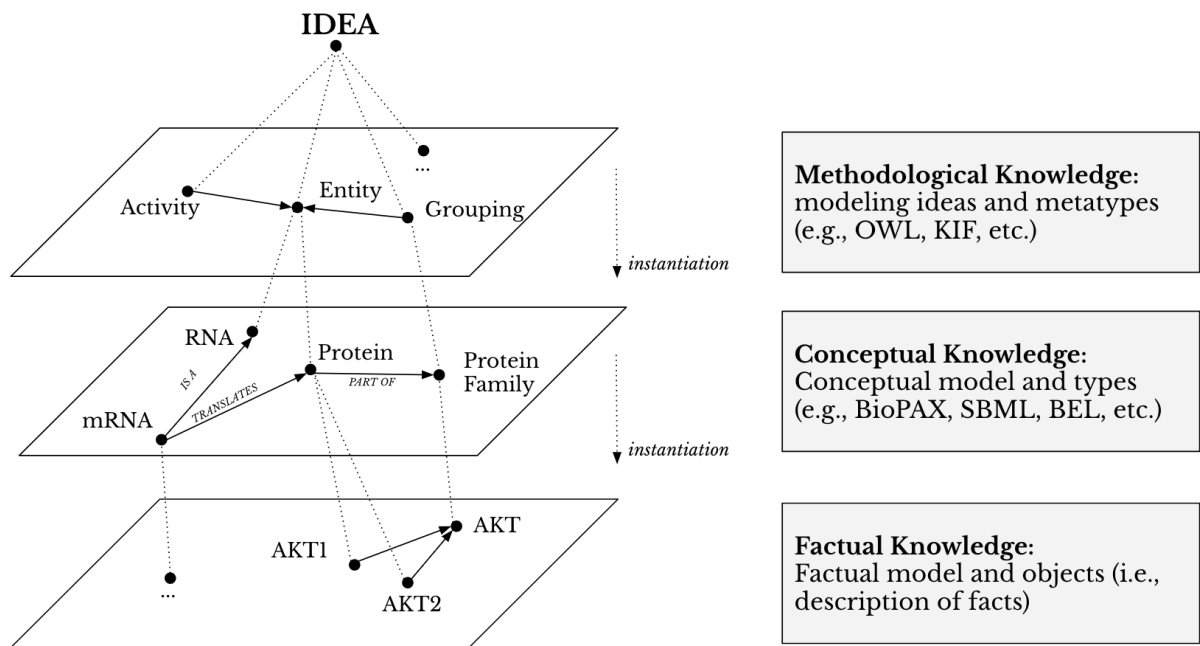

Figure 2: The interplay of the three levels of knowledge abstraction in an example from the biological domain. This figure can be cited directly with [50].

1.2.1 Realizations

Resource Description Framework Schema

Resource Description Format (RDF) uses triples of subjects, predicates, and objects to represent relations between concepts. Each resource in a triplet is backed by an Internationalized Resource Identifier (IRI). While its simple format grants it expressive power, RDF lacks structure or domain specificity. RDFS is a set of concepts and predicates appropriate for describing knowledge at the conceptual level. Included are predicates for asserting class hierarchies (`rdfs:subClassOf`), asserting memberships (`rdf:type`), describing the domain and range of predicates (`rdfs:domain`, `rdfs:range`), and representing epistemological concepts such as classes, literals, and other data types [51]. RDF and RDFS are supported by most popular programming languages with packages to serialize and deserialize RDF in a variety of formats (e.g., eXtensible Markup Language (XML), N-Triples, turtle, etc.) and reason over RDFS.

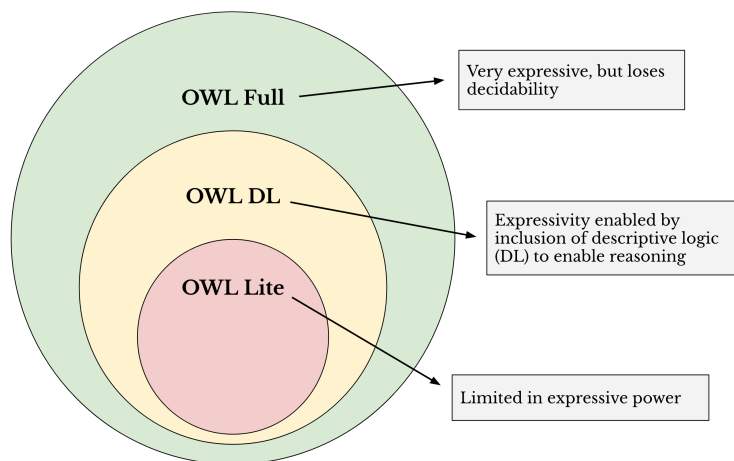

Figure 3: The expressive levels of OWL ontologies. Adapted from [49].

Web Ontology Language

Like RDFS, OWL consists of the methodological knowledge for modeling domain-specific knowledge. Its most simple form, OWL Lite, enables the representation of classes, their properties, relations, and constraints. The most common form, OWL Descriptive Logic (DL), contains the additional expressive power of descriptive logic over which inferences can be made. The most expressive form, OWL Full, removes the remaining restrictions on OWL DL but paradoxically becomes undecidable and hinders automatic reasoning [49].

Open Biomedical Ontologies

As the usage of ontologies began to percolate into the biomedical domain, Ashburner and Lewis proposed the OBO standard [52] to encourage the standardization of formats and identifiers, to promote openness and community feedback, and to organize information in logical units. The OBO Foundry [53] has emerged as a central repository that has successfully supported collaboration such as the collation of several previously disparate ontologies into the Cell Line Ontology [54]. Because the syntax of OBO is not directly compatible with OWL, several converters exist to further support the integration of OBO with other aspects of the Semantic Web.

1.2.2 Standardized Curation of Biological Pathways

As biological knowledge is generated from experiments or extracted from the literature it must be stored in a standard format to be generally useful. This section describes several of those formats and their applicability domains.

Biological Pathways Exchange Language

BioPAX uses OWL to define the conceptual knowledge in the domain of biological pathways on the molecular and cellular level. Its ability to collect and index metabolic, signaling, molecular, gene-regulatory, and genetic interaction networks makes it an ideal exchange format for the growing number of pathway databases with varying specificities in regards to target organisms and disease indications [55].

This was realized with the aggregation of several pathway and interaction databases (e.g., BindingDB [56], DrugBank [57], IntAct [58], Kyoto Encyclopedia of Genes and Genomes (KEGG) [59], Reactome [60], WikiPathways [61], etc.) to form the Pathway Commons Database [62]. Immediately, this database enabled exploration of molecular interactions at the highest granularity. For example, it powers the Enrichment Map Cytoscape Plugin [63] that was used to support data-driven analysis in identifying medulloblastoma subgraphs based on intratumoral heterogeneity [64].

Systems Biology Markup Language

SBML uses a custom formalism defined with XML to represent the dynamic and quantitative aspects of biochemical reactions, signal transduction, and gene regulatory networks [65]. Like BioPAX, it provides the conceptual framework necessary to encode knowledge in the biomedical domain. SBML also provides the basis for CellDesigner [66], which has been incredibly successful in allowing biologists without informatics backgrounds to diagram gene regulatory and biochemical networks as well as import them to graphical ordinary differential equation solvers and simulation workflows.

Gene Ontology Causal Activity Models

Gene Ontology Causal Activity Models (sGO-CAMs) (<https://geneontology.cloud/docs>) combine disparate Gene Ontology (GO) annotations to generate networks of relationships between genes, their molecular functions, the biological processes in which they participate, and the cellular components in which they reside. Relationships between genes can be expressed using terms from the Relations Ontology (<http://www.obofoundry.org/ontology/ro.html>) and processed using its rich set of axioms. GO-CAMs are relatively new compared to the other formats, but have the potential to provide the most standardized interpretation of the molecular interactions for which GO is already the standard resource.

Biological Expression Language

BEL supports the assembly of context-specific qualitative causal and correlative relations between biological entities across multiple scales. Statements are assembled and serialized in BEL Script with full provenance information including namespace references, relation provenance (citation and evidence), and relation metadata such as biological context (i.e. anatomy, cell, disease, etc.) [67]. The schemata of BEL relations and BEL Scripts are depicted in Figures 4 and 5, respectively.

Data-driven network analyses on BEL knowledge assemblies have been successfully performed across a wide variety of clinical applications, including the identification of upstream controllers in hepatocytes [68], mechanistic hypothesis generation for drug response [69], and patient stratification [70] by using over-representation analysis techniques developed such as RCR [71] and pathway topological analytical methods such as NPA [72].

The foray into new disease areas and clinical indications has necessitated the assembly of knowledge on wider scales from the genetic to the phenotypic and population levels. While most modeling languages and data formats for assembling knowledge are insufficient for such a task, BEL possesses the faculty for capturing multi-scale knowledge.

In the same way BioPAX was successful at combining many molecular pathway and interaction database, BEL has the potential to serve as a semantic integration platform through which knowledge and data across scales can be integrated and analyzed. BEL can be used to reason over the previously untapped sources of

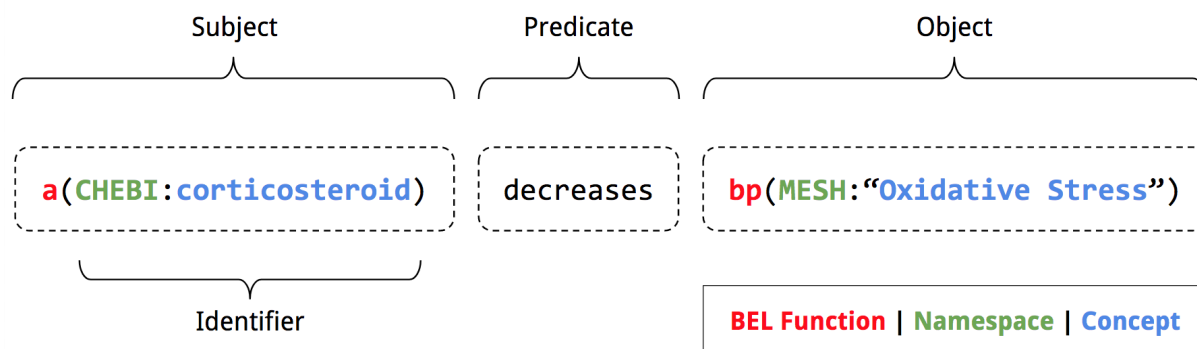

Figure 4: A BEL relation is encoded as a triplet containing a subject, a predicate, and an object. The predicate can represent the type of relation while the subject and object can either represent the abundance of molecular entities such as genes, proteins, chemicals, or more abstract concepts such as biochemical reactions, biological processes, and pathologies. Identifiers for these concepts use references to external namespaces (Figure 4B) to qualify their respective names. In this example, Chemical Entities of Biological Interest (ChEBI) [73] is used to qualify chemicals and Medical Subject Headings (MeSH) [74] for biological processes. This figure can be cited at [75].

chemogenomic and chemical genetic information in the realm of disease-disease, disease-protein, disease-chemical, and chemical-chemical networks.

Modeling interactions across scales is not without its issues. As biological processes, pathologies, and phenotypes represent collections of molecular interactions, they are prone to having excessive associative and correlative relations to other biological entities. This biases typical graph mining algorithms that rely on graph traversals to visit these types of nodes, and therefore produce less meaningful results. While it is not within the scope of this thesis, there are many solutions for addressing these issues whose complexities vary from simple filtering to empirical traversal rules or adding extra rules for traversals.

Systems Biology Graphical Notation

Systems Biology Graphical Notation (SBGN) [76] attempts to address the inconsistency and ambiguity of current non-standardized notations for biological pathways that is problematic among BioPAX, SBML, BEL, and other standardized notations. It encompasses three variants: processes diagrams, entity relationship

A

```
# Document Metadata
SET Name = "Alzheimer Disease Knowledge Assembly"
SET Version = "1.0.0"
...
```

B

```
# Namespace Definitions
DEFINE NAMESPACE CHEBI = "http:// ... /chebi.belns"
...

# Annotation Definitions
DEFINE ANNOTATION Disease = "http:// ... /disease.belnanno"
...
```

C

```
# Relation Metadata
SET Citation = {"PubMed", "...", "..."}
SET Evidence = "...
SET Disease = "Alzheimer Disease"
...

# Relation Statements
a(CHEBI:corticosteroid) decreases bp(MESH:"Oxidative Stress")
...
```

Figure 5: A BEL Script contains three sections: A) the document metadata section provides provenance information such as the name, version, and author; B) the definitions section provides references to external resources that are used as identifiers and metadata in the relations section; and C) the relations section contains BEL relations and their metadata: minimally including a citation and evidence with the possibility to include additional information such as biological context (e.g., cell, anatomy, disease). This figure can be cited at [75].

Table 4: Examples of qualities of biological relationships and their attributes

Quality	Choices
Types of Relation	Causal, Correlative, Associative, Ontological
Directionality of Relation	Unidirectional or Bidirectional (reflexive)
Polarity of Relation	Increases, Decreases, None
Causality of Relation	Direct or Indirect
Modes of Entity	Activity, Abundance, Efflux
Modifications of Entity	Post-translational modifications, gene/protein fusions, mutations
States of Entity	Subcellular Location, pre-/post-conditions

diagrams, and activity flow diagrams. In a process diagram, each entity is depicted along with its transformations to other entities and the regulators of those processes. In the entity relationship diagram, each entity appears only once and relationships are considered independent. In the activity flow diagram, a direct presentation of the influence between entities is favored over their relationships' mechanistic underpinnings. This variant is most related to BEL and GO-CAMs, while the others are more useful for the specific mechanistic processes that are often described in SBML models.

1.2.3 Standardized Curation of Biological Knowledge

There exist thousands of biological data databases describing different biological phenomena with varying semantics and levels of granularity (Table 4). While many have begun to use standardized ontologies and knowledge formats, many remain. Further, the use of standard formats does not guarantee interoperability [77]. Integrative approaches have begun to alleviate this burden for domain-specific use cases (e.g., gene set enrichment analysis on pathway and gene set databases). In Chapter 5, a general approach for creating integrative databases using BEL is described.

Further, the quantity of knowledge in the biomedical domain is increasing at an unprecedented rate, with no signs of deceleration. Even with the assistance of information retrieval technologies, it is overwhelming, if not impossible, for individuals or groups of researchers to be knowledgeable of the state-of-the-art in any but an incredibly specific topic. Therefore, researchers need the assistance of automated relation extraction systems to assist in the enrichment of previously existing knowledge available and integrated from relevant, high-quality databases.

Table 5: Examples of relation extraction and reading systems with varying degrees of domain specificity

Type	Name	Reference
General Purpose	Eidos	https://github.com/clulab/eidos
	TRIPS/CWMS	http://trips.ihmc.us/parser/cgi/cwmsreader
	Hume	https://github.com/BBN-E/Hume
	Sofia	https://sofia.worldmodelers.com/ui/
Biology-Specific	TEES	https://github.com/jbjorne/TEES
	REACH	https://github.com/clulab/reach
	TRIPS/DRUM	http://trips.ihmc.us/parser/cgi/drum
	Sparser	https://github.com/ddmcdonald/sparser
	MedScan	[78]
	RLIMS-P	https://research.bioinformatics.udel.edu/rlimsp
	ISI/AMR	https://github.com/sgarg87/big_mech_isi_gg
BEL-Specific	Geneways	[79]
	BELIEF	[80]
	BelSmile	[81]
	BELTracker	[82]
	BELMiner	[83]

The work in this thesis makes use of an ensemble of natural language processing-based, rule-based, and machine-learning based relation extraction systems through the Integrated Dynamical Reasoner and Assembler (INDRA) interface. References to several of its constituent general purpose and biology-specific relation extraction systems are listed in Table 5. Additionally, it contains a sampling of BEL-specific relation extraction systems popularized by the corresponding BioCreative V BEL Task (<https://biocreative.bioinformatics.udel.edu/tasks/biocreative-v/track-4-bel-task>).

Issues with Automated Relation Extraction Systems

Neither relation extraction systems based on rules, natural language processing, nor machine learning are without their issues. None constitute general artificial intelligence, and thus all require maintenance and improvement to sustain their abilities to process recent scientific literature; each requires increasingly large and carefully annotated corpora to support the generation of new rules or train the extraction system to recognize new relationships.

Because relation extraction systems have many subsystems with their own sub-tasks, the errors from each propagate throughout. NER remains a difficult task due to the availability and generation of supporting ontologies that precisely describe given terms. Though it remains unpublished and tangential to the work presented in this thesis, during the course of the curation of unstructured information outlined in Chapter 4, an ontology was generated to capture the complex terminology surrounding the human microtubule associated protein Tau. It was then extended during curation of other related candidate pathophysiological mechanisms of the aetiology of Alzheimer’s disease (AD) and named the Curation of Neurodegeneration Supporting Ontology (CONSO) (<https://github.com/pharmacome/conso>). While CONSO formalizes the terminology and discourse from the scientific literature for protein aggregation processes in several neurodegenerative diseases (e.g., Huntington’s disease, AD, Parkinson’s disease (PD)), it also illustrates that the large and ongoing effort required to formalize a single area of molecular biology is not easily scaled to cover all possible biology.

Despite their recent improvements, automated relation extraction systems still omit an important aspect of systems and networks biology: the biological context. By focusing on the sentence level, it remains difficult, if not impossible, for these systems to extract the information pertaining to the cell, cell line, tissue, model organism, disease context, or other contextual information that is crucial for the understanding of complex biology. Even with their issues, automated relation extraction systems can be incredibly powerful when combined with manual curation in semi-automated workflows. With careful generation of new terminologies, the inclusion of contextual information that can currently best be found by purely manual effort, and rational prioritization of automatically generated content for manual review, semi-automated workflows can make huge improvements in both the quantity, quality, and relevance of knowledge assembles. Ultimately, these improvements lead to better downstream analysis as described in the following.

1.3 Algorithms Applicable to Graphs

Algorithms for analyzing pathways and networks have been placed into three main categories by [84]: Over Representation Analysis (ORA), Functional Class Scoring (FCS), and Pathway Topology (PT). ORA often focuses on the number of differentially expressed genes present or absent in a gene set compared to chance, while FCS is less susceptible to large effects and considers the aggregate of groups of small effects. PT finally considers the biological relations between members of

the pathway during analysis.

1.3.1 BEL Algorithms

Martin *et al.* made the distinction between methods that rely on the assumption that protein activities are correlated with their corresponding mRNAs' expression changes (forward reasoning) versus the effect that upstream controllers of mRNA expression have (backwards reasoning) [72]. These algorithms have been developed for a wide variety of applications, data formats, and graph types. While many are heterogeneous, below are the most notable algorithms specific to networks from knowledge assemblies encoded in BEL.

Reverse Causal Reasoning

Reverse causal reasoning (RCR) is an approach to identify the upstream controllers of biological patterns measured in an experiment; often differential gene expression experiments between healthy and diseased patients. First, large knowledge assemblies are dissected into smaller hypothesis networks with one upstream node with multiple outgoing causal relations to target nodes represented by the experimental data set. Each hypothesis network is scored by its concordance between the observed up- and down-regulation of targets nodes to the sign of the causal relation and by its richness, or the explanatory power of the hypothesis network [71]. An example hypothesis network is shown in Figure 6.

Network Perturbation Amplitude

While RCR gives preliminary insights to significant biological controllers, it mostly ignores the topology of signaling, regulatory, and other causal networks that can be represented in knowledge assemblies (Figure 7). The NPA measures the aggregated effect explained by the controller layer with reference to a given node with respect to their downstream nodes. Two complementary statistics for the effect of permutations of the upstream layer and downstream layer allow for further insight to the validity of NPAs as a hypothesis generation mechanism [72].

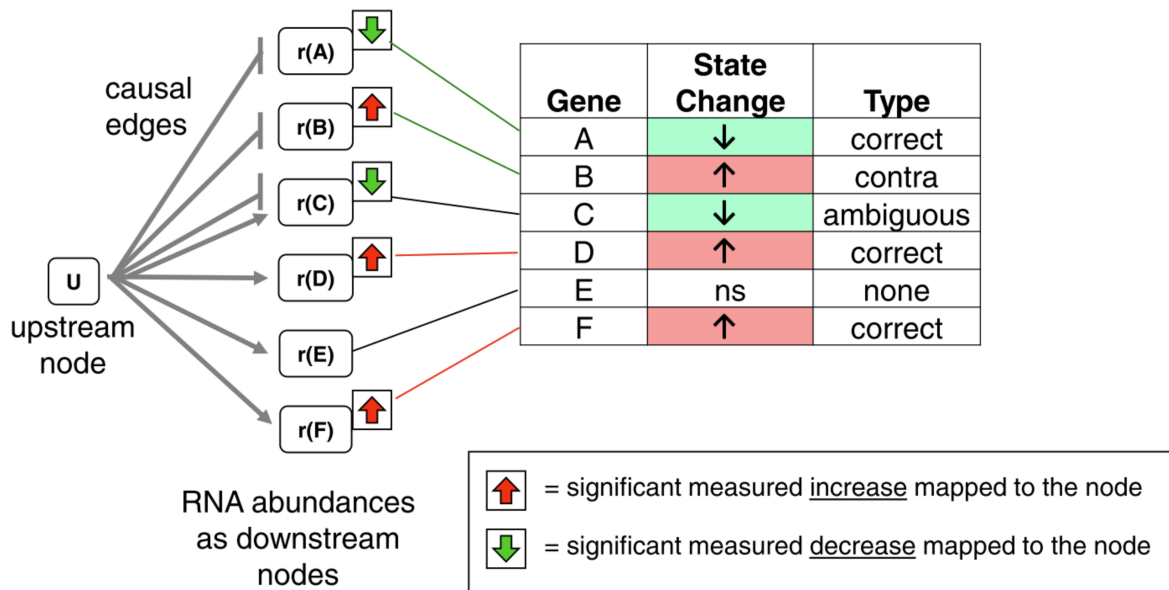

Figure 6: An example hypothesis network. Target nodes are counted as correct if they have a decreasing relationship and down-regulation, or an increasing relationship and up-regulation. Target nodes with multiple conflicting relationships are marked as ambiguous. Finally, target nodes are counted as incorrect if they have a mismatch between an increasing relationship and down-regulation, or a decreasing relationship and up-regulation. Adapted from [71].

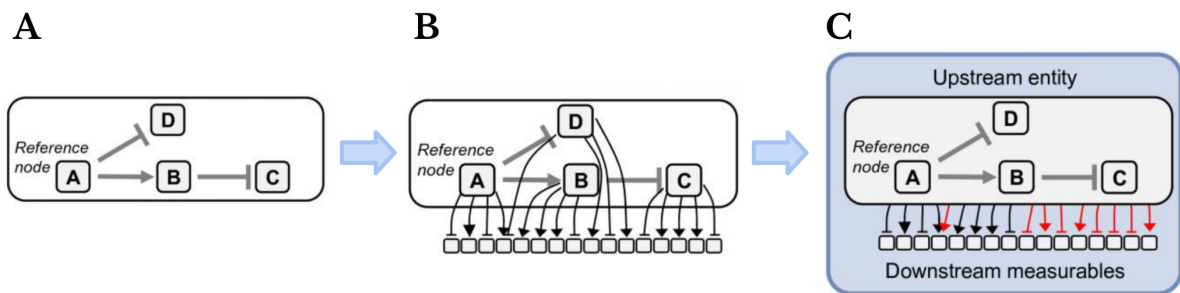

Figure 7: Creation of hypothesis networks that accounts for the topology and interactions of upstream controller layer with respect to a reference node A), their individual effects on the downstream layer B) and their combine effect C). Adapted from [85].

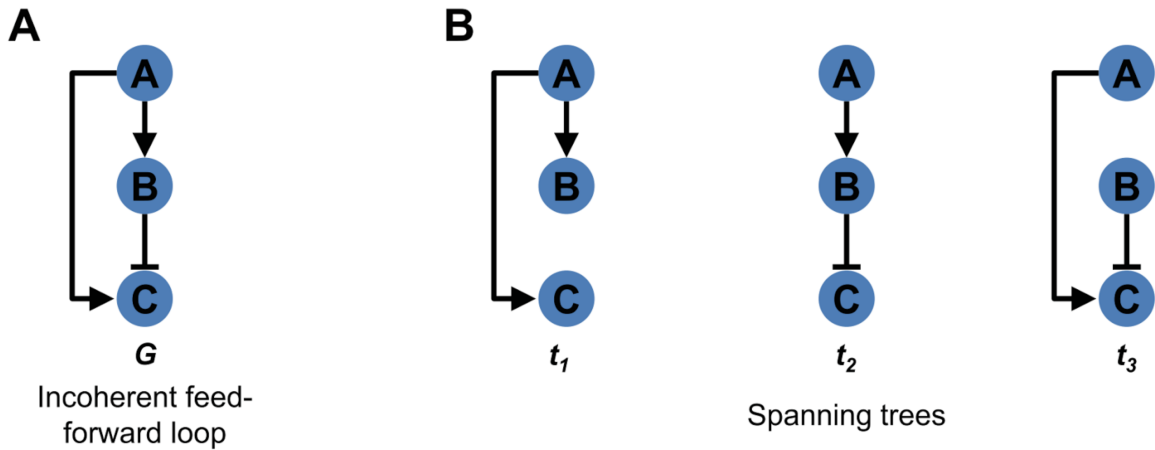

Figure 8: An example decomposition of a small causally inconsistent network A) to its spanning trees B). Figure adapted from [86].

Sampling of Spanning Trees

While NPA enables more informed analyses than RCR, its mathematical basis limits the topologies of knowledge networks that can be used to those with causal consistency. In these networks, all paths from one node to another result in the same aggregated effect of increases and decreases. An additional approach in Figure 8 for Sampling of Spanning Trees (SST) with random walkers eliminates inconsistencies and can be aggregated over multiple trials to assign NPA scores to networks that were otherwise inconsistent [86].

1.3.2 Network Representation Learning

Representation learning methods have the goal of generating low-dimensional, continuous vector representations for entities in high-dimensional, heterogeneous data sets (e.g., images, text sequences, etc.). More specifically, network representation learning (NRL), also known as Knowledge Graph Embedding (KGE), learns representations of nodes and edges from Knowledge Graphs (sKGs) in continuous vector spaces that can be used in downstream machine learning tasks such as edge prediction, entity clustering, and entity disambiguation [87]. Several methods inspired by linear algebra, deep learning, and natural language processing have arisen in previous years as shown in Table 6.

Table 6: Examples of three types of KGEMs

Model Type	Name	Reference
Translational Distance	Structured Embedding	[88]
	TransE	[89]
	Unstructured Model	[90]
	TransH	[91]
	TransR	[92]
	TransD	[93]
Semantic Matching	RESCAL	[94]
	ERMLP	[95]
	DistMult	[96]
	ConvE	[97]
Random Walk	DeepWalk	[98]
	Gat2Vec	[99]
	node2vec	[100]
	edge2vec	[101]
	metapath2vec	[102]
	LINE	[103]

Translational Distance Models

Each translational distance model learns entity and relation embeddings in euclidean space by defining first an equation relating the corresponding embeddings with the models' hyperparameters and second a distance-based measure of the plausibility of a given triple f_r [87].

An example of an established translational distance model is TransE [89]. It models a class of relation r as the translation from a head entity h (i.e., the subject of a triple) to a tail entity t (i.e., the object of a triple) in a representative euclidean space as $h + r \approx t$. It measures the plausibility of a given triple with the following scoring function:

$$f_r(h, t) = -\|h + r - t\| \quad (1.1)$$

The closer the embedding of the tail is to the sum of the head and relation embeddings, the higher is the probability that the triple is correct. However, because TransE is limited in modeling $1 - N$, $N - 1$, and to $N - M$ relations, several extensions have been proposed (e.g., TransH, TransR, and TransD).

TransH extends TransE by representing each relation in a relation-specific hyperplane with normal vector w_r [91]. Before scoring, the head and tail entities are projected using the following equations before using the same scoring function as in TransE.

$$h_{\perp} = h - w_r^{\top} h w_r \quad (1.2)$$

$$t_{\perp} = t - w_r^{\top} t w_r \quad (1.3)$$

Finally, the translation vector r from TransH is constrained to be within the hyperplane defined by w_r before applying the following scoring function.

$$f_r(h, t) = -\|h_{\perp} + r - t_{\perp}\|_2^2 \quad (1.4)$$

Alternatively, TransR [92] and TransD [93] use independent projection matrices for the head and tail entities to allow for greater expressibility. However, these models have more parameters and thus require more data to train well.

Semantic Matching Models

Unlike translational distance models, semantic matching models use similarity-based scoring functions that measure the plausibility of a given triple based on the "latent semantics" of the entities and relations [87]. An example of an established semantic matching model is RESCAL [94]. It represents each entity as a vector and each relation as a matrix, M_r , that encodes pairwise interactions between the head and tail entities of a triple, using the following scoring function:

$$f_r(h, t) = h^{\top} M_r t \quad (1.5)$$

The DistMult model simplifies RESCAL by restricting M_r to be a diagonal matrix, denoted as $diag(r)$ in order to reduce the number of model parameters while simultaneously improving the efficiency of computation [96].

$$f_r(h, t) = h^T \text{diag}(r) t \quad (1.6)$$

Both translational distance models and semantic matching models can be trained using the margin ranked loss [97, 104] in order to maximize the difference between positive triples (i.e., $f_r(h, t)$) and negative ones (i.e., $f_r(h', t')$). This scoring function has the benefits that it can readily integrate a variety of scoring functions $f_r(h, t)$ and it is amenable to the possibility that a negative triple may also be true, but just not included in the knowledge graph. The margin ranking loss can be optimized with stochastic gradient descent while iterating through batches of positive triples and sampled negative ones [105].

$$L = \sum \max(0, f_r(h', t') - f_r(h, t) + \lambda) \quad (1.7)$$

Random Walk Models

Random walk models generate embeddings for nodes in knowledge graphs by applying the concepts from natural language models (e.g., SkipGram, word2vec, and Global Vectors (GloVE)) to random walks.

The first, DeepWalk [98], generates a corpus of random walks from the knowledge graph starting from each node by uniformly randomly choosing an adjacent node at each step in the walk until the target length was achieved or no unvisited neighbors remained. These walks were used to train the *SkipGram* [41] model in which the random walks were considered as sentences and nodes were considered as words. Because *SkipGram* is a language model that maximizes the co-occurrence probability of words in the same window, the node vectors reflect the local structure of the input KG (Figure 9). It is further rationalized by the observation that the distribution of nodes' appearances in random walks mirrors words in free text [98]. Several aspects of knowledge graphs were not addressed by DeepWalk, including the community structure of the second neighbors of each nodes, the types of nodes, the types of edges, and attributes of nodes and edges.

Node2vec [100] addresses the community structure of the second neighbors of each node by modifying the random walk process to include second-order random walks, where the probability of walking to each neighbor from a given node is also influenced by its previous steps. Node2vec has been independently

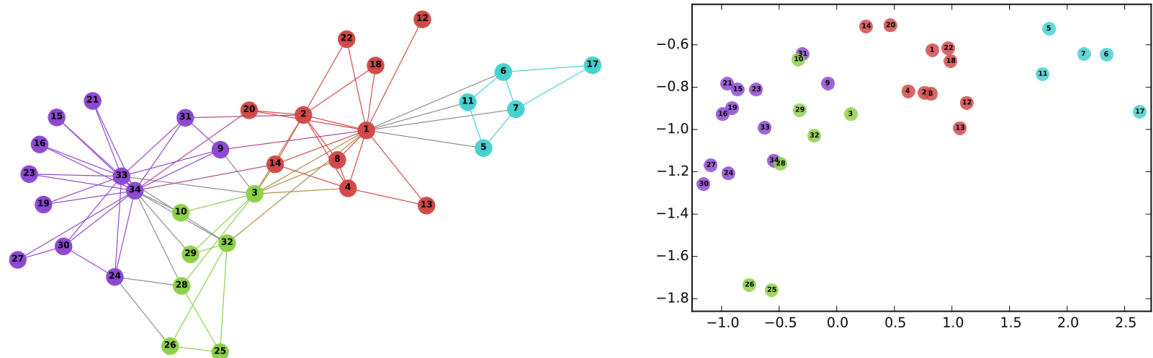

(a) Input: Karate Graph (b) Output: Representation

Figure 9: DeepWalk produces embeddings that reflect the community structure of the underlying KG. Figure adapted from [98]

implemented several times, but most suffer from difficulty in implementing second order walking both in terms of algorithmic understandability and from a computational perspective. Recently, the implementation at <https://github.com/VHRanger/graph2vec> has solved many of those issues with both an elegant and efficient implementation. Edge2vec [101] took a similar approach to node2vec by calculating probabilities of traversing each edge type based on the previous steps in a walk. It was able to better capture the underlying distributions in knowledge graphs with multiple edge types. Metapath2vec [102] created random walks that included the node types and edge types in order to address their absence, and Gat2vec [99] added attributes as actual nodes to knowledge graphs such that they could be incorporated (and then filtered) from random walks.

Random walk methods are very powerful in that most rely on changing the random walk generation, and the workflow can be maintained. While it has not yet been done, this leaves significant improvement for abstraction of this methodology and development of powerful and flexible computational frameworks for future research.

Applicability of Network Representation Learning

Biological knowledge encoded in many of the previously mentioned formats (e.g., BioPAX, SBML) can be directly translated into KGs to which NRL can be applied.

Because of the importance of community structure in biological networks [106], random walk models have the most appropriate formulation for capturing the underlying patterns in biological networks. A direct comparison for several types of biological networks including protein-protein interaction networks, miRNA-target networks, and other multimodal networks is currently under development following the contribution of related work from this thesis to [107].

1.4 Applications

While Chapters 2, 3, 4, and 5 cover the generation, enrichment, and exploration of biological knowledge graphs, Chapters 6, 7, and 8 cover three areas in which biological knowledge graphs can be used to support drug discovery. While there have been many previous computational, network-based methods that have been used for these purposes, most rely on narrowly-focused databases with low granularity or slow update. The final chapters focus on adapting these methods to higher granularity knowledge encoded in BEL for the drug repositioning task in which a new indication is proposed for a previously clinically studied chemical. Further, these approaches can be carefully adapted for precision medicine, in which the use of a given drug should be prescribed to a given patient or subgroup of patients instead of an entire population.

1.4.1 Simulation

Two of the simplest categories of biological models are boolean and logical models. In these graphical models, nodes have boolean states that change through time based on logical rules encoded in the model. Two prominent examples of boolean models are Petri Nets [108] and boolean networks [109], but there have been many following successes with more complicated formulations [110–112].

One of the most powerful simulations of biological systems comes from partial differential equations, which have the ability to precisely encode both spatial and temporal events as well as their evolution through time [113]. However, they suffer the drawbacks that they have a high number of unknown parameters either due to the lack of available experimental data or due to unknown intermediate processes. Further, fitting differential equations with high number of variables (more than several hundred) is very difficult.

Agent-based models offer an alternative in which a small set of rules can be used to infer emergent properties of a more complex system through simulation and optimization. However, their definition is painstaking, and it is difficult to include the most relevant biological knowledge. Chapter 6 explores one way biological knowledge can be used to influence the generation and application of these types of models to understanding basic biological processes in AD.

1.4.2 Target Prioritization

Target prioritization is the task of ranking proteins based on their relevance to a given disease and likelihood of being a successful therapeutic target. As many drugs fail in clinical trials due to low efficacy, the choice of appropriate targets whose modulation has a therapeutic effect is paramount in drug development for both the pharmaceutical industry and for patients [114, 115]. While targets have been traditionally identified and validated based on literature evidence describing mRNA expression, protein expression, knockout mice, somatic mutations, copy number variations, gene fusions, and other biological phenomena, manual interpretation of the growing body of literature is becoming difficult, if not impossible [116–118]. Computational approaches towards target prioritization offer a more viable alternative as structured biological data sources become more ubiquitous. However, computational target prioritization does not directly assess ligandability nor druggability, so computational approaches must be complemented by both the appropriate functional experiments (e.g., knockdown studies) and physical studies (e.g., binding assays).

Because of their utility in data integration, many computational target prioritization methods are based on networks. The common paradigm in network-based target prioritization methods is guilt-by-association, which presumes nodes connected to similar groups of nodes have similar properties. Many target prioritization methods use this paradigm to assume that similar proteins have similar functions and therefore candidates can be proposed on their similarity to previously known targets. While this may limit guilt-by-association methods in their ability to prioritize novel targets, they are still considered robust [119].

Chapter 7 explores a novel method for calculating similarities between proteins based on NRL and improving the state-of-the-art pipeline presented by Emig *et al.* [120]. While initial work used the same protein-protein interaction networks and disease-specific differential gene expression profiles, it can be extended to accommodate the rich knowledge encoded in BEL networks (i.e., causal, mecha-

nistic interactions like phosphorylations, inhibition, receptor agonism as well as correlations observed in the clinic between patients with conditions and molecular patterns) generated by manual, semi-automated, and automated approaches described elsewhere in this thesis.

1.4.3 Mechanism of Action Deconvolution

Understanding the mechanism of action of a given compound not only gives insight into its efficacy in a given therapeutic indication but also possible off-target effects. Many of off-target effects may be harmful to a patient, and are often studied through the lens of toxicology [121]. Therefore, a better mechanistic understanding might be useful not only in mitigating off-target effects but also in drug repositioning, where off-target effects are proposed as targets for other indications. Further, investigations of the mechanism of action of a given compound have remained target-centric and have yet to access the mechanistic causal knowledge contained within biological knowledge graphs.

Network representation learning techniques are well-suited to capture patterns in compound-target pairs and can also use the high granularity mechanistic causal knowledge graphs whose generation is described in this thesis. The embeddings generated for nodes and edges can be directly applied to the drug repositioning task by scoring the likelihood of an edge existing between a previously studied drug and a disease both existing within a network of drugs, targets, diseases, drug-target-interactions, and disease-target associations. While this simple approach has been described in several publications, NRL methods allow for the easy incorporation of new entities and relation types, such as side effects and drug-side effect annotations. Further, the constraints of drug repositioning can be related to solve the more general problem of drug discovery, which involves assessing the likelihood of the existence of an edge between any chemical and any disease. Upcoming methods in NRL allow for the inclusion of literals [122] into the learning process. For biological knowledge graphs containing compounds and compound-target interactions, this enables the incorporation of chemical fingerprints into the learning process that have been previously successfully used in the fields of chemogenomics [123, 124] and proteochemometrics [125].

In order to generate efficacious therapies, mechanism of action deconvolution must be paired with knowledge about the underlying aetiological mechanisms of disease. In the field of neurodegenerative diseases, this task is severely limited by knowledge about the diseases. NeuroMMSig provides not only high-quality

manually curated candidate mechanisms for AD, PD, and epilepsy as biological knowledge graphs in BEL, but also an enrichment algorithm that goes beyond the most basic and common described by [84] in order to incorporate the mechanistic causal information contained in the underlying knowledge graphs.

The NeuroMMSig knowledge graphs and the enrichment algorithm are used in Chapter 8 to deconvolute the mechanism of action of the anti-epileptic, carbamazepine, that has also shown therapeutic effect in AD. It ranked disease-specific mechanisms in AD and epilepsy that are likely targeted by carbamazepine and ultimately lead to the hypothesis that the GABA-ergic receptor pathway was central to its multi-indication effect. Importantly, this investigation was advantageous over black-box machine learning models because the underlying knowledge assemblies are self-explanatory and based on publications in molecular biology and epidemiology.

Finally, the conclusion of this thesis considers the implications of moving from single targets to entire mechanisms for future drug repurposing and drug discovery, as motivated by chapters on target prioritization (Chapter 7) and mechanism of action deconvolution (Chapter 8).

2 PyBEL: a computational framework for Biological Expression Language

Preface

While BEL had been previously demonstrated to support the combination of data and knowledge in analyses [69–72, 85, 86], manual curation and disease modeling [126–131], and storage of biomedical text mining results [80–83, 132]; its surrounding computational ecosystem was incredibly limited.

The previously existing software provided by Selventa, the original developer of BEL, was aging and not amenable to extension or interactive computational investigation that is becoming mainstream with the advent of the Jupyter Notebook [133]. In order to leverage the unique ability of BEL to integrate multi-scale and multi-modal knowledge to support downstream simulation, target prioritization, mechanism of action deconvolution, and other methods, it was necessary to build a new ecosystem for BEL that is presented in the following publication.

Reprinted with permission from "Hoyt, C. T., Konotopez, A., & Ebeling, C. (2017) PyBEL: a computational framework for Biological Expression Language. *Bioinformatics (Oxford, England)*, 34(4), 703–704". Copyright © Hoyt, C.T., et al., 2017.

Systems biology

PyBEL: a computational framework for Biological Expression Language

Charles Tapley Hoyt^{1,2,*}, Andrej Konotopez¹ and Christian Ebeling¹

¹Department of Bioinformatics, Fraunhofer Institute for Algorithms and Scientific Computing (SCAI), Sankt Augustin 53754, Germany and ²Department of Life Science Informatics, Bonn-Aachen International Center for IT, Rheinische Friedrich-Wilhelms-Universität Bonn, Bonn 53113, Germany

*To whom correspondence should be addressed.

Associate Editor: Jonathan Wren

Received on July 5, 2017; revised on September 28, 2017; editorial decision on October 16, 2017; accepted on October 17, 2017

Abstract

Summary: Biological Expression Language (BEL) assembles knowledge networks from biological relations across multiple modes and scales. Here, we present PyBEL; a software package for parsing, validating, converting, storing, querying, and visualizing networks encoded in BEL.

Availability and implementation: PyBEL is implemented in platform-independent, universal Python code. Its source is distributed under the Apache 2.0 License at <https://github.com/pybel>.

Contact: charles.hoyt@scai.fraunhofer.de

Supplementary information: [Supplementary data](#) are available at *Bioinformatics* online.

1 Introduction

Among the most popular modeling and data exchange languages in systems biology are currently the Biological Pathways Exchange (BioPAX), Systems Biology Markup Language (SBML) and Biological Expression Language (BEL). BioPAX captures metabolic, signaling, molecular, gene-regulatory, and genetic interaction networks (Hucka *et al.*, 2003); SBML accommodates mathematical models of biochemical networks, cellular signaling, and metabolic pathways (Demir *et al.*, 2010); and BEL assembles qualitative causal and correlative relations between biological entities across multiple modes and scales, with full provenance information including namespace references, relation provenance (citation and evidence), and biological context-specific relation metadata (anatomy, cell, disease etc.) (Slater, 2014).

Although there exist several software packages for BioPAX and SBML, the ecosystem of open-source software for BEL is much more limited. An assessment of previous software (see [Supplementary Table S3](#)) shows there is an unmet need for easily installable, stable, facile software that parses modern BEL and provides programmatic access to a data container that enables the resulting network to be extended, queried, manipulated, analyzed, and visualized. Furthermore, a converter between common data formats is needed to enable re-usability and interoperability between general and BEL-specific software for network analysis and visualization.

Here, we present PyBEL; a software package designed to fulfill each of these needs.

2 Software architecture

The PyBEL software package consists of five main components: (i) network data container, (ii) parser and validator, (iii) network database manager, (iv) data converter and (v) network visualizer.

Although a graph refers to an abstraction for a set of objects (i.e. nodes) and their relations (i.e. edges), its instantiation in a real-world application is often called a network. We provide an implementation of a directed multigraph (i.e. a graph whose edges have directionality and any given pair of nodes may have multiple edges) that maps the biological entities and concepts in the subjects and objects of BEL relations to nodes in a network and their relations, with corresponding metadata, to edges. We extended the MultiDiGraph class from NetworkX (<http://networkx.github.io>) to enable users direct access to their suite of network algorithms and static visualizations to support their further development into biologically meaningful analyses.

The parser performs tokenization, lexical analysis, parsing, and validation on each of the three sections of BEL documents (see [Supplementary Figs S1 and S2](#)). Callbacks are used to annotate the entries in the document metadata section to a network instance, download and store the resources referenced in the definitions section,

maintain a list of current annotations from SET statements, and parse BEL relations to populate a network instance with the corresponding nodes, edges, and their metadata from the current internal state. Although relations' syntax is implicitly validated, the semantics of their subjects' and objects' identifiers are validated against the references from the definitions section. Finally, feedback is provided to users to support thoughtful re-curation, which could lead to more robust knowledge assemblies and enable more reproducible science.

Namespaces and networks are cached with a relational database to improve the speed of validation and access to data. Although relational databases lack the faculty for applying network algorithms, they provide indexing functionality that enables complicated queries and filters over the nodes, edges, and metadata of increasingly large collections of networks. For example, this could help identify intersections and potential cross-talk between disease-specific networks.

We implemented lossless converters for common file formats including Node-Link JSON, JGIF, CX, and binary as well as for database formats including SQL, Neo4J, and NDEX. We also provide lossy exporters to Excel, CSV, SIF, XGMML, and GSEA to facilitate usage in other programs. Notably, we have deferred implementing a RDF (Resource Description Framework) converter until improvements are made to the existing BEL to RDF mapping and its documentation (<https://wiki.openbel.org>). Future work will also include converters for BioPAX and SBML. See [Supplementary Tables S1 and S2](#) for more detailed descriptions of each format.

Networks can be exported for visualization in Cytoscape or uploaded to NDEX ([Pratt et al., 2015](#)) to take advantage of its viewer and simple query interface. Alternatively, we provide an interactive network explorer tailored to BEL networks (appropriate node coloring, metadata pop-ups etc.) that can be directly embedded as HTML in email, Jupyter Notebook, or a web application. It has already been used to produce visualizations in the NeuroMMSig Web Service ([Domingo-Fernández et al., 2017](#)). [Supplementary Figures S3–S5](#) present these visualizations side-by-side. In addition to their programmatic interfaces, the parser, storage, conversion, and visualization features are exposed via a command line tool.

3 Case study

The PyBEL suite includes functions for querying and mutating networks with which it implements state-of-the-art algorithms for over-representation analysis, functional class scoring, and pathway topological analysis of BEL networks such as Reverse Causal Reasoning ([Catlett et al., 2013](#)). [Figure 1](#) presents a case study in which a novel heat diffusion work flow was used to assess the observed impact on biological processes from differential gene expression in Alzheimer's disease (AD). Technical documentation is included in the [Supplementary Material](#).

4 Discussion

Even after its v2.0 update, BEL does not yet explicitly specify many concepts in molecular biology such as epigenetic information ([Irin et al., 2015](#)). The inevitability of language evolution prompted us to develop the parser in modules so that new syntax could be proposed and implemented quickly. As a proof of concept, a syntax extension for gene modifications is included in the package by default.

Historically, BEL has used a custom namespace file format, but the creation and maintenance of biological terminologies has tended towards using OWL (Web Ontology Language). Furthermore, many domains (e.g. SNPs) are growing too large to enumerate during semantic integration and validation. The modular architecture of the parser enables easy implementation of new definition file formats,

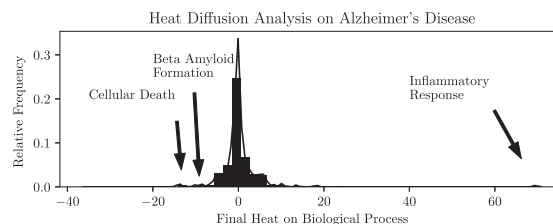

Fig. 1. Plotted is the distribution of the final heat on biological processes from the NeuroMMSig AD Knowledge Assembly ([Domingo-Fernández et al., 2017](#)) following heat diffusion analysis with a differential gene expression experiment from the brains of AD patients (E-GEOD-5281, [Liang et al., 2007](#)). The significant down-regulation of biological processes related to inflammatory response (heat = 69) and up-regulation of cellular death (heat = -13) and beta-amyloid formation (heat = -9) match common clinical observations and serve as a validation for this approach

external validation services, or even alternative namespace definition schemes to address these issues.

Although BEL is often used to formalize knowledge curated from unstructured sources, our software also enables the integration of knowledge from structured sources. For example, existing solutions for resolving equivalences across namespaces rely on the creation and hosting of extensive lookup tables. Alternatively, the parser could be extended with a dedicated syntax and draw equivalencies directly from OWL.

Finally, we plan to present this software as a web service to enable a wider audience of researchers across disciplines to validate, explore, and analyze their BEL networks.

Acknowledgements

We thank Sumit Madan and Scott Colby for their advice and feedback.

Funding

This work was supported by the European Union/European Federation of Pharmaceutical Industries and Associations (EFPIA) Innovative Medicines Initiative Joint Undertaking under AETIONOMY [grant number 115568], resources of which are composed of financial contribution from the European Union's Seventh Framework Programme (FP7/2007-2013) and EFPIA companies in kind contribution.

Conflict of Interest: none declared.

References

- Catlett, N. et al. (2013) Reverse causal reasoning: applying qualitative causal knowledge to the interpretation of high-throughput data. *BMC Bioinformatics*, **14**, 340.
- Demir, E. et al. (2010) The BioPAX community standard for pathway data sharing. *Nat. Biotechnol.*, **28**, 1308–1308.
- Domingo-Fernández, D. et al. (2017) Multimodal Mechanistic Signatures for Neurodegenerative Diseases (NeuroMMSig): a web server for mechanism enrichment. *Bioinformatics (Oxford, England)*, btx399.
- Hucka, M. et al. (2003) The systems biology markup language (SBML): a medium for representation and exchange of biochemical network models. *Bioinformatics (Oxford, England)*, **19**, 524–531.
- Irin, A.K. et al. (2015) Computational Modelling Approaches on Epigenetic Factors in Neurodegenerative and Autoimmune Diseases and Their Mechanistic Analysis. *J. Immunol. Res.*, **2015**, doi:10.1155/2015/737168.
- Liang, W.S. et al. (2007) Gene expression profiles in anatomically and functionally distinct regions of the normal aged human brain. *Physiol. Genomics*, **28**, 311–322.
- Pratt, D. et al. (2015) NDEX, the network data exchange. *Cell Syst.*, **1**, 302–305.
- Slater, T. (2014) Recent advances in modeling languages for pathway maps and computable biological networks. *Drug Discov. Today*, **19**, 193–198.

Postface

In order to make the PyBEL ecosystem sustainable, it was made open source, easily installable, integrated with existing systems in systems and networks biology, tested, and well-documented. The ease with which PyBEL could be used to implement a variant of the heat diffusion algorithm described by [134] was then demonstrated.

While PyBEL contained several imports and exports for other software used by systems and network biologists, it still lacked an accessible interface for biologists. It was also alluded that knowledge from structured sources could be integrated, especially from other standards like BioPAX and SBML. Each of these are addressed in Chapters 3, 4, and 5.

PyBEL has been used by many scientists in a variety of projects and presentations. It was originally developed in the Fraunhofer SCAI Department of Bioinformatics for usage in the International Medicine Initiative (IMI) project, AETIONOMY¹, to support the generation of a taxonomy of mechanisms underlying neurodegenerative diseases such as AD, PD, and epilepsy as well as patient stratification. One of the project's major deliverables, NeuroMMSig [131] was originally built with an ad-hoc database, but the upcoming version has been rewritten using PyBEL in order to take advantage of its entire ecosystem. Following AETIONOMY, PyBEL has also been used in and presented at the general assembly [135] of the IMI project, PHAGO², which focused on the role of the TREM2 and CD33 proteins in AD.

The Fraunhofer SCAI Department of Bioinformatics has relied on PyBEL for the compilation, validation, and summarization of manually curated BEL documents in several internal and industry projects. Three funded collaborations with Cohen Veterans Bioscience used PyBEL during the manual curation of causal and mechanistic knowledge related to post-traumatic stress disorder and traumatic brain injury. One industry contract for an undisclosed partner focused on the manual curation of causal and mechanistic knowledge related to several psychiatric conditions used PyBEL for compilation, validation, summarization, and visualization. The visualization tools developed during this project became the basis for BEL Commons, presented in Chapter 3, that are also being reused in the Horizon 2020

¹<https://www.aetionomy.eu/>

²<https://www.phago.eu/>

project, VirtualBrainCloud³. A funded academic collaboration with the Cytoscape Consortium⁴ focused on the integration of PyBEL with NDEx [136] such that BEL documents could be uploaded and handled in NDEx using its CX format, as well as to enhance interoperability of both BEL and CX with RDF. An internally funded project, The Human Brain Pharmacome Project⁵, has used PyBEL for compilation, validation, and analysis of BEL documents related to tauopathies and later more general neurodegenerative disease phenomena. An internally funded project at the Fraunhofer Center for Machine Learning has used PyBEL as a source of biomedical triples for the training of knowledge graph embedding models in the bio2vec⁶ project and resulted in the following publication [107]. A project granted by the Human Brain Project⁷, the Reference Ontology Hub with Application services for Neurosciences⁸ has used the terminology management functions of PyBEL that later became Bio2BEL.

PyBEL has been used by external groups, including several pharmaceutical companies part of the AETIONOMY project as well as interest from Clarivate Analytics, who provide their Metacore⁹ knowledge base as BEL to customers.

Finally, PyBEL has been used in several publications and theses by other members of the Fraunhofer SCAI Department of Bioinformatics [77, 137, 138] as well as slow uptake by the broader community of systems and network biologists [111, 139] and further upcoming masters and doctoral theses.

³<https://cordis.europa.eu/project/rcn/219020/factsheet>

⁴<http://www.cytoscapeconsortium.org>

⁵<https://pharmacome.scai.fraunhofer.de>

⁶<https://bio2vec.net>

⁷<https://www.humanbrainproject.eu>

⁸<https://www.scai.fraunhofer.de/en/business-research-areas/bioinformatics/projects/Rohan.html>

⁹<https://clarivate.com/products/metacore/>

3 BEL Commons: an environment for exploration and analysis of networks encoded in Biological Expression Language

Preface

The following publication describes BEL Commons, a web application that enables exploration and analysis of networks encoded in BEL as well as the integration of several disparate features from other prominent web applications for systems and networks biology. While PyBEL, described in Chapter 2, rejuvenated the aging BEL ecosystem, it did not yet make the new tools or algorithms accessible to a general audience of biologists interested in systems and networks biology research. BEL Commons attempts to address that accessibility gap.

The publication highlights the way BEL Commons enables integrative exploration of several publicly available knowledge bases and provides an example from the IMI project, AETIONOMY, of a coalesced data- and knowledge-driven analysis that used publicly available differential gene expression data sets related to AD and knowledge assemblies from NeuroMMSig [131].

Reprinted with permission from "Hoyt, C. T., Domingo-Fernández, D., & Hofmann-Apitius, M. (2018). BEL Commons: an environment for exploration

and analysis of networks encoded in Biological Expression Language. *Database*, 2018(3), 1–11". Copyright © Hoyt, C.T., *et al.*, 2018.



Original article

BEL Commons: an environment for exploration and analysis of networks encoded in Biological Expression Language

Charles Tapley Hoyt^{1,2,*}, Daniel Domingo-Fernández^{1,2} and Martin Hofmann-Apitius^{1,2}

¹Department of Bioinformatics, Fraunhofer Institute for Algorithms and Scientific Computing, 53754 Sankt Augustin, Germany and ²Bonn-Aachen International Center for IT, Rheinische Friedrich-Wilhelms-Universität Bonn, 53115 Bonn, Germany

*Corresponding author: Tel: +49 2241 14 2268; Fax: +49 2241 14-2656; Email: charles.hoyt@scai.fraunhofer.de

Citation details: Hoyt, C. T., Domingo-Fernández, D. and Hofmann-Apitius, M. BEL Commons: an environment for exploration and analysis of networks encoded in Biological Expression Language. *Database* (2018) Vol. 2018: article ID bay126; doi:10.1093/database/bay126

Received 3 April 2018; Revised 25 July 2018; Accepted 5 November 2018

Abstract

The rapid accumulation of knowledge in the field of systems and networks biology during recent years requires complex, but user-friendly and accessible web applications that allow from visualization to complex algorithmic analysis. While several web applications exist with various focuses on creation, revision, curation, storage, integration, collaboration, exploration, visualization and analysis, many of these services remain disjoint and have yet to be packaged into a cohesive environment.

Here, we present BEL Commons: an integrative knowledge discovery environment for networks encoded in the Biological Expression Language (BEL). Users can upload files in BEL to be parsed, validated, compiled and stored with fine granular permissions. After, users can summarize, explore and optionally shared their networks with the scientific community. We have implemented a query builder wizard to help users find the relevant portions of increasingly large and complex networks and a visualization interface that allows them to explore their resulting networks. Finally, we have included a dedicated analytical service for performing data-driven analysis of knowledge networks to support hypothesis generation.

Database URL: <https://bel-commons.scai.fraunhofer.de>

Introduction

There exists a variety of modeling languages, data formats and analytical tools for systems and networks biology. Among the most popular modeling languages are the

Biological Pathways Exchange [BioPAX, (1)], Systems Biology Markup Language [SBML, (2)], Systems Biology Graphical Notation [SBGN, (3)] and Biological Expression Language [BEL, (4)]. BioPAX captures metabolic, signaling,

molecular, gene-regulatory and genetic interaction networks; SBML captures mathematical models of biochemical networks, cellular signaling and metabolic pathways; SBGN provides a graphical representation of ideas from BioPAX and SBML; and BEL captures qualitative causal and correlative relations between biological entities across multiple scales (e.g. *-omics*, pathway, cellular, phenotypic) with accompanying biological and contextual annotations. While each modeling language has their own domain-specific syntax and semantics, each facilitates assembling biological relations into networks. For example, BEL formalizes relations as triplets each composed of a subject, predicate and object in order to generate pathways and networks when the object from one relation is again used as the subject of another. We refer to Saqi *et al.* (5) for a more thorough comparison of the applicabilities of various modeling languages.

Currently, these modeling languages and their related analytical tools require deep knowledge of computer programming to use and are generally inaccessible to a wider audience of biologists and clinicians. With the explosion of data and knowledge in the biomedical domain, it is paramount to develop tools that foster collaboration between groups of scientists with different backgrounds and skill sets who are working toward similar goals. Already, there are multiple freely available, web-based tools for systems and networks biology with varying focuses on creation, revision, curation, storage, integration, collaboration, exploration, visualization and analysis. Below, we provide a brief review of services appropriate for each focus.

Because of the accelerating throughput of scientific publication in the biomedical domain, several general workflows [e.g. Reading and Assembling Contextual and Holistic Mechanisms from Text (REACH) (6), TRIPS (7), Turku Event Extraction System (TEES) (8), MedScan (9)] and several BEL-specific workflows [e.g. Biological Expression Language Information Extraction WorkFlow (BELIEF) (10), BELMiner (11), BelSmile (12), BELTracker (13)] have been developed to automate biological relation extraction. The limits of the precision and recall of automated techniques, the applicability domains of different modeling languages and the need for expert input motivated the development of semi-automatic and manual curation interfaces [e.g. SBV Improver (14), BELIEF Dashboard (15), WikiPathways (16)] to drive crowdsourced creation, revision and curation of knowledge networks.

While many useful knowledge resources [e.g. miRTarBase (17), Comparative Toxicogenomics Database (CTD) (18), Kyoto Encyclopedia of Genes and Genomes (KEGG) (19)] still disseminate their data in non-standard formats, the use of the aforementioned modeling languages

has become much more common as in the case of the integration effort of Pathway Commons (20). Other web tools [e.g. NDEx (21), GraphSpace (22)] provide the ability to upload, store, share and distribute networks while remaining agnostic to format. Most of these resources also include network visualization, layout and exploration with PathVisio (23), Cytoscape (24), Cytoscape.js (25), as well as in-browser navigators.

Numerous algorithms and analyses have been published for systems and networks biology but most are bespoke due to the heterogeneous nature of their underlying knowledge networks, data sets and the scientific questions motivating their development. An exception lies with gene set enrichment analysis: a technique for finding gene sets, pathways and networks in which a query gene set (e.g. a list of differentially expressed genes) is over- or under-represented (26). Its simplicity has led to its implementation and inclusion in several web applications as well as several applications to reveal patterns of dysregulation in *-omics* data sets as exemplified by the Enrichment Map Cytoscape Plugin (27, 28) with Pathway Commons as well as Gene Set Enrichment Analysis (GSEA) (29) with MSigDB (30).

Recently, BEL has been successfully used as a semantic and modeling framework for multi-scale and multi-modal knowledge in order to investigate the etiology of complex neurodegenerative diseases as shown by Domingo-Fernández *et al.* (31) with the NeuroMMSig Mechanism Enrichment Server. While the list of published BEL-specific algorithms is currently short (e.g. Reverse Causal Reasoning (32), Network Perturbation Amplitude (33) etc.), recent developments in the BEL software ecosystem have improved the accessibility and utility of BEL and have motivated its wider adoption (34). Unfortunately, unlike many of the other focuses of web applications, algorithms have remained confined to use by bioinformatics and inaccessible to a wider audience of researchers across disciplines. Last, but not least, the ecosystem of BEL-specific web applications is small and does not include a service for parsing, validating, compiling and converting BEL.

There are still several unmet needs for users that motivate the development of new web applications. Generally, there is still the need to enable complex exploration and visualization as well as to make algorithms and analyses generally accessible and reusable. Specifically to BEL, there is a need to make parsing, validating, compiling and converting facile and user-friendly. Finally, an integrative knowledge discovery environment that comprises many of the previously mentioned features would be greatly beneficial to the BEL and overarching scientific community. Here, we present BEL Commons, a web application that addresses these unmet needs and is a first attempt at building such an environment.

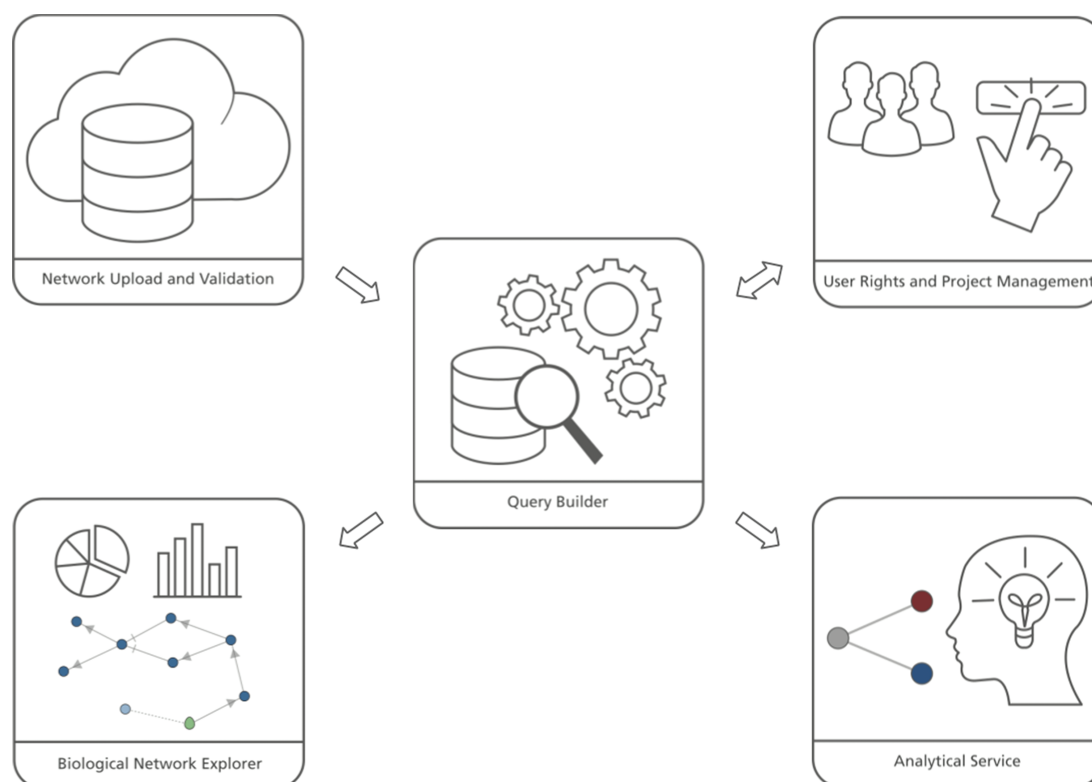

Figure 1. BEL Commons comprises several components: (i) the network uploader and validator, (ii) user rights and project management, (iii) the query builder, (iv) the biological network explorer and (iv) the analytical service.

Implementation and components

The user interface of BEL Commons integrates several features from the variety of previously mentioned web applications for systems and networks biology (Figure 1). It contains five main components: (i) the network uploader, where users can upload, parse, validate and compile BEL as well as generate several summaries of its contents; (ii) user rights and project management, where users can share their networks with various granularities; (iii) the query builder, where users can interactively query networks and make transformations; (iv) the biological network explorer, where users can visualize, explore and further modify networks; and (v) the analytical service, where users can run heat diffusion experiments with *-omics* data. Below, we elaborate on their functionalities and typical use cases. Implementation details can be found in the [Supplementary Data](#).

Network uploader

The first point of entry for many users of BEL Commons will be through its BEL uploader, which allows users to choose a file from their computer to upload and to toggle common parsing and compilation parameters. After submitting, users' files are sent to an asynchronous task queue,

implemented with RabbitMQ (<https://www.rabbitmq.com>) and Celery (<http://www.celeryproject.org>), which performs parsing, validation and compilation with PyBEL (34) in the background. Errors and warnings encountered during parsing are enumerated, statistics over the resulting network are produced, biological network motifs are identified and, finally, the submitter is notified upon completion.

The parsing errors and warnings are categorized first as syntactic or semantic then with much more detail, as described on the BEL Commons help page (<https://bel-commons.scai.fraunhofer.de/help/parser>). Each is presented with provenance information including the line, line number and position so curators can quickly make changes. Recurring errors and warnings are identified and grouped separately to allow curators to quickly make impactful improvements. Finally, a faceted search is presented for situations where an overwhelming number of errors and warnings are present.

The statistical summary (Figure 2A) of the network presents information about the contents of the network and also network theoretic measurements of the full network. Several charts are generated depicting the types and number of nodes, edges, modifications, namespaces, annotations and citations existing in the network. Furthermore, scalar

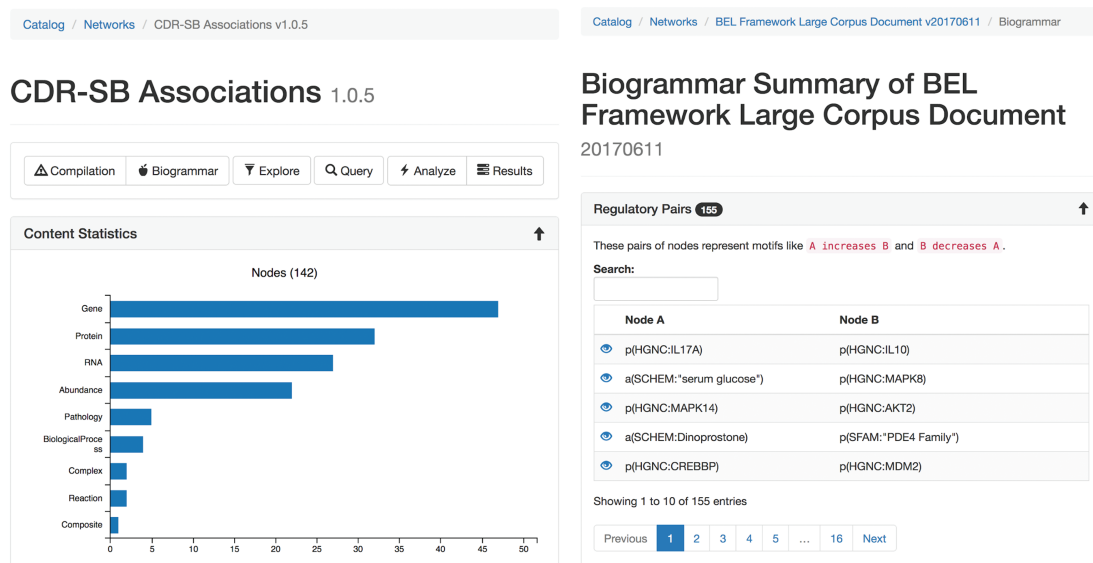

Figure 2. The statistical (A, left) and biogrammar (B, right) summary pages.

values describing network properties such as network density, average node degree and node overlap with other networks in BEL Commons using the Szymkiewicz-Simpson coefficient are listed.

The ‘biogrammar’ summary (Figure 2B) of the network presents an analysis of network motifs generalized from the analysis of transcriptional network motifs presented by Alon (35) for use with knowledge networks. BEL Commons focuses mainly on simple motifs that are informative to the robustness, correctness and applicability of a given knowledge work. The most simple motif is the contradictory pair, where knowledge has been curated stating *A increases B* but also *A decreases B*. Searching this motif in NeuroMMSig identified the contradiction that RB1 has been shown to not only increase the transcriptional activity of E2F4 by

Li *et al.* (36) but also decrease the transcriptional activity of E2F4 (37). Another motif is an inconsistent negative correlation triple, where knowledge has been curated stating *A negatively correlates with B*, *B negatively correlates with C* and *C negatively correlates with A*. After, several factors can be used to estimate the confidence of the correctness and applicability of the statements such as biological context (e.g. cell line, tissue, disease), reference type (e.g. experimental paper, review paper, database), text location (e.g. abstract, introduction, methods, discussion) or the date of publication. BEL Commons currently only identifies predefined, small motifs containing two or three nodes, but could be extended to automatically find larger ones with the caveat that their biological meanings are more difficult to interpret.

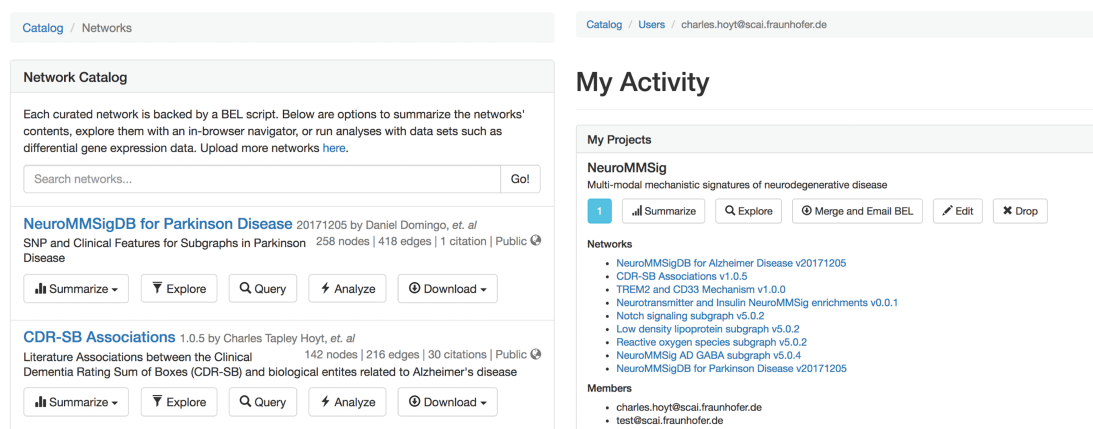

Figure 3. The network catalog (A, left) and user activity page (B, right).

Table 1. Statistics over a selection of the resources publicly initially available in BEL Commons. These numbers are accurate to the best of our ability, but may not reflect nominal values from their sources depending on the ability of PyBEL to parse their contents

Resource	Networks	Nodes	Edges	Citations
Selventa Example Corpora (http://resources.openbel.org)	5	16 339	36 971	5083
Causal Biological Networks Database (38)	138	5343	28 766	4580
NeuroMMSig (31)	8	1411	3221	201

User rights managements and collaboration

Upon BEL upload, users are presented with the option to make the resulting network either public or private. Networks can be uploaded privately for use during research then later released publicly to accompany a publication and share their work with the scientific community. The network catalog (Figure 3A) dynamically shows users only networks for which they have the appropriate permissions.

Users can create projects that allow for multiple users to mutually share networks. For example, a curation project in a given disease area could contain networks generated from the efforts of multiple curators. Projects can generate a merged network that can be summarized, explored, analyzed and exported with the same tools available for stand-alone networks. Users can access their private activity page (Figure 3B), which provides a global summary over their projects, networks, queries, data sets and experiments.

We do not presume all users plan to produce their own BEL, especially with the growing number of both general and context-specific publicly available resources. In light of this, we have included several of these resources in BEL Commons for these users (Table 1). The catalog of networks for which users have the appropriate permissions can be accessed directly from the home page of BEL Commons.

Query builder

While networks arising from BEL can be readily merged, it becomes increasingly difficult to visualize and explore large networks and combinations of networks. The query builder assists users in generating powerful, precise and expressive queries that find the most relevant and interesting subnetworks in three steps: (i) users search and select relevant networks; (ii) users generate a subnetwork specifying the most interesting nodes, edge annotations and references with their preferred *seeding method(s)*; and (iii) users select transformations (e.g. enrichments, selections, filters) to apply to the resulting subnetwork.

The first step in the query builder allows users to select networks relevant to their scientific questions. While it still remains computationally feasible to query over a merged view of the entire catalog of networks, users have the

opportunity to pre-select the most relevant networks on the basis of their specificities toward target disease areas, curation methods or any other appropriate criteria described in their metadata. Additionally, other high-quality structured knowledge resources such as protein families (39, 40), biochemical reactions (41, 42) and gene orthologs [e.g. Entrez Gene (43), Mouse Genome Informatics (MGI) (44), Rat Genome Database (RGD) (45) etc.] can be included to enrich networks from curated BEL. Later, we will show how this novel feature can be used to enrich networks as a pre-processing step to connect disparate components before analysis.

The second step in the query builder allows users to generate subnetworks based on nodes, edge annotations and references of interest by using one or several ‘seeding methods’. An example of seeding method that most network-related web applications implement is the retrieval of the Nth neighbors of a given node or set of nodes. Because neighborhood queries are often insufficient to capture complex biology, BEL Commons implements several additional seeding methods, enumerated in Table 2, that allow users to take advantage of the directionality, polarity and rich annotations inherent to networks from BEL. Using these seeding methods, the query builder allows scientists to ask scientific questions like the one proposed in the following scenario: the leukemia drug, nilotinib, triggers cells to remove faulty components, including ones associated with several brain diseases (46). In 2015, the Georgetown University Medical Center published findings that the drug had a therapeutic effect on patients with Alzheimer’s and Parkinson’s diseases (47). Though the drug’s mechanism of action is currently unknown, a path search between nilotinib and these diseases suggests it could be by decreasing phosphorylation of the Tau protein, which may have a therapeutic effect in both disease contexts, through inhibition of ABL1 (48, 49).

The third step in the query builder allows users to specify transformations (e.g. enrichments, selections, filters) to apply to network resulting from the assembly in the first step then the seeding in the second step. Users may select basic transformations, such as deleting single nodes or edges, to more complex transformations such

Table 2. Seed methods available in the query builder

Seed method	Description
Nth neighbors	This induces a subnetwork over nodes in paths of length less than or equal to N from any query node, terminating at any node, including ones not included in the query.
Upstream subnetwork	This induces a subnetwork over nodes with causal edges targeting the query nodes then repeats a second time for that subnetwork in order to include a second layer. Finally, induces all causal edges between resulting nodes.
Downstream subnetwork	This induces a subnetwork over nodes with causal edges originating from the query nodes then repeats a second time for that subnetwork in order to include a second layer. Finally, induces all causal edges between resulting nodes.
Shortest paths	This induces a subnetwork over all nodes in the shortest paths between any pair of query nodes, implemented by NetworkX (50).
All paths	This induces a subnetwork over all nodes in all of the paths (length less than seven) between any pair of query nodes, implemented by NetworkX (50).
Provenance	This builds a subnetwork from all edges with provenance from articles with the given PubMed identifiers.
Authors	This builds a subnetwork from all edges from articles written by authors with the given names.
Annotations	This builds a subnetwork from all edges matching given biological or contextual annotations.

as selecting a subnetwork only consisting of causal edges. BEL Commons dynamically loads transformation functions from PyBEL such that new functions, pipelines and workflows for processing networks can be written quickly and made available to users. A full list is available at <https://bel-commons.scai.fraunhofer.de/help/query-builder>.

Each query is saved with a unique identifier such that queries can be rerun, shared, merged and compared. Rather than storing the results of queries, the selection, seeding and transformations are stored as a ‘transaction’ so that they can be applied to new assemblies, for example, when a network is updated. Effectively, queries correspond to an experimental protocol for processing raw networks before visualization, exploration, analysis and interpretation. However, the construction of a query is not the end of its life. The next section summarizing the biological network explorer describes how queries can be extended and evolve during the process of scientific inquiry.

Biological network explorer

The biological network explorer provides users with easy ways to visualize BEL networks to interpret their underlying structures, to investigate the metadata on nodes and edges and to interactively update networks as they explore (Figure 4). It is built with D3.js (<https://d3js.org>) to render networks with a force-directed layout algorithm that can be panned and zoomed. Because the complexity of biological networks often limits the utility of automated layouts (51), users can also manually drag and reposition nodes. Furthermore, users can adjust the edge length parameter of the algorithm to rarefy densely grouped nodes and improve readability. The networks are styled with minimum visual clutter and make use of easily dis-

tinguishable colors rather than obtrusive shapes for nodes as well as patterns and colors for different types of edges.

The explorer has several contextual actions registered to the nodes and edges. Users can left-click a node to populate the information box located below the explorer with information from external data sources [e.g. Entrez Gene, ChEBI (52), ExPASy (40), Gene Ontology (53)] gathered from Bio2BEL services (<https://github.com/bio2bel>) and the EMBL Ontology Lookup Service (54). Alternatively, users can right-click a node to open a contextual menu that enables further modification to the network (e.g. delete the node, add the neighbors of the node to the network) that are interactively appended to the original query used to render the visualization. The contents of the network can also be further modified by the inline query builder, which allows additional transformations to be applied interactively. The query history is displayed at the bottom of the explorer, new changes are highlighted in red, and because queries are stored as transactions, changes can be reverted with an ‘undo’ button.

When an edge is clicked, the information box is populated with relevant citations, evidences and annotations. Each edge is linked to a voting and commenting system so domain-specific experts, curators and bioinformaticians can engage in discussion on the correctness and robustness of the chosen representation of knowledge.

To the right of the explorer is the filter tool box, which incorporates a novel approach to filtering and exploring networks using a linked hierarchical explorer of the terminologies/ontologies annotated to the edges in the currently displayed networks. Users can search and select groups of annotations to filter the network. For example, this could be useful to exclude edges asserted from research on cell lines that are not relevant. The filter tool box has three additional

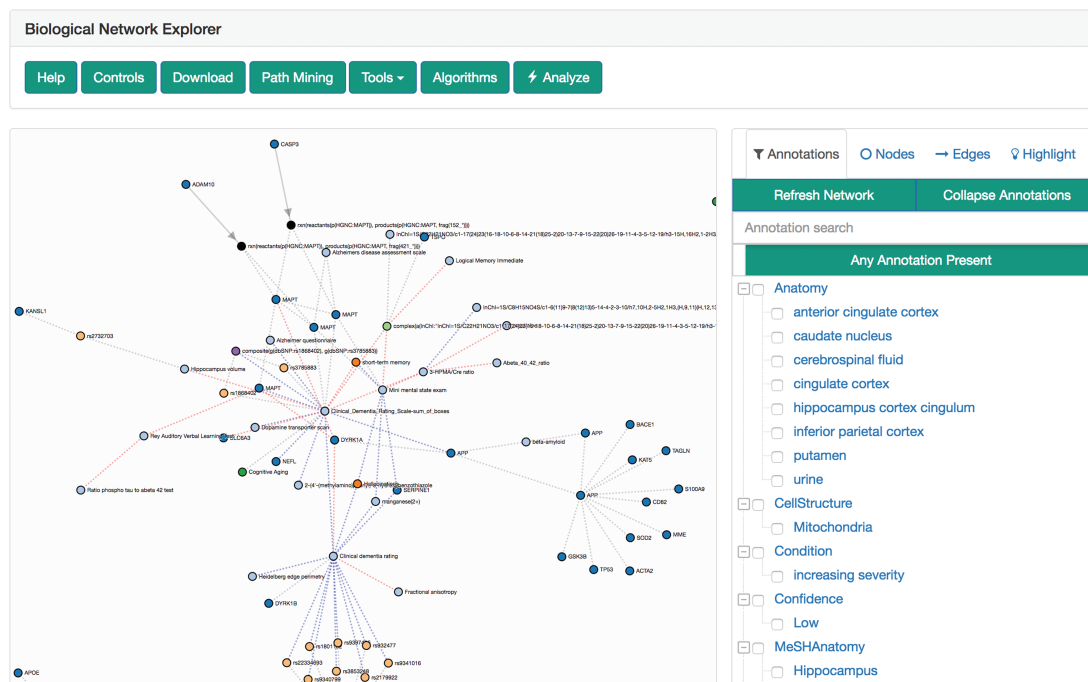

Figure 4. The biological network explorer and related navigation components. Truncated from this image are the node information and query information boxes.

tabs: nodes, edges and highlight. Users can either search for specific nodes and edges in their corresponding tabs or use the highlight tab to select nodes and edges with specific properties to highlight in the network.

Above the explorer is the general tool box that includes several additional interactions for exploration, analysis and export of the network using the serializers described by Hoyt *et al.* (34). Notably, it contains a path mining tool that enables path searches between given nodes with fine granular, configurable settings (e.g. directedness, path search algorithm, application of filters for pathologies etc.). Hence, it can immediately be used to identify the causal root affecting two nodes or generate hypothetical links across modes and scales.

The visualization can be further modified by resizing the nodes corresponding to the results of topological or data-driven analyses, such as their degree, betweenness centrality or by the results of an experiment (e.g. heat diffusion with *-omics* data, see next section) in order to identify novel biological entities.

Finally, there are several alternatives to exploring networks that are too large to render in-browser due to the limits of JavaScript-based graphics. First, the network catalog opts to present users with a random subsampling of large networks. If a network in the explorer becomes too big, then the explorer prompts the usage of the filter tool box to identify a more relevant, smaller network. Otherwise, users

can export the current network to multiple formats for use in desktop visualization applications.

Analytical service

Khatri *et al.* categorized algorithms for analyzing pathways and networks in three types: over-representation analysis, functional class scoring and pathway topology (26). Algorithms of each type have been developed for a wide variety of applications, data formats and network types, but most are difficult to use and few are specific to networks from BEL. The BEL Commons analytical service begins to address this issue by coupling a heat diffusion workflow to the query builder and explorer to create a more seamless user experience.

In the context of network science, heat diffusion refers to annotating a scalar value to each node (i.e. heat) and simulating how it spreads through nodes' adjacent edges to their neighbors over several iterations. It has been used successfully in systems and networks biology to assess the connectivity of nodes and identify important subnetworks as demonstrated by Leiserson *et al.* with the HotNet2 algorithm (55).

BEL Commons exposes a similar workflow, previously presented by Hoyt *et al.* (34), that has the added behavior based on the polarity of causal edges—when heat crosses a *decreases* edge, its sign is flipped to better capture the

aggregate effect of heat flowing from several edges with mixed polarity to a single node. Because BEL contains several entity types, users are presented with the final heats on biological process nodes to assist in interpreting which processes are dysregulated in the experiment. A more detailed description of this method can be found at <https://bel-commons.scai.fraunhofer.de/help/heat-diffusion>.

Users can upload pre-processed, high throughput *-omics* experiments (e.g. differential gene expression data) and map them to a network either by starting in the network catalog or through the biological network explorer's toolbox. The network and *-omics* data are then sent to the task queue to perform the heat diffusion workflow. Upon completion, users are notified via email with a link to the results page that shows statistics and data visualization. Finally, users are also able to overlay the results on the original network in the biological network explorer.

In the following section, the query builder, biological network explorer and analytical service are used to assess several differential gene expression experiments representing patients with Alzheimer's disease at different disease states using NeuroMMSig networks.

Application scenario

This section describes a use case in which a disease-specific network for Alzheimer's disease is assembled and pre-processed. First, the network is explored with the biological network explorer; second, it is enriched; and finally, it is analyzed with differential gene expression data in order to identify patterns of dysregulation of biological processes that are specific to disease progression stages.

We uploaded several BEL documents describing Alzheimer's disease pathophysiology generated during the AETIONOMY project (<https://www.aetionomy.eu>) that were originally stored in NeuroMMSig (<https://neurommsig.scai.fraunhofer.de>) to BEL Commons. We began by using the query builder to search for and select all of these networks. Next, we used the 'Annotations' seeding method (Table 2) to generate a subnetwork composed of edges that had been annotated in BEL with membership in the following candidate mechanisms of Alzheimer's disease pathophysiology from NeuroMMSig. We chose the low density lipoprotein subgraph, the GABA subgraph, the notch signaling subgraph and the reactive oxygen species subgraph because they are dysregulated at different disease stages. Later, we will capture these different progression patterns by running the heat diffusion workflow with stage-specific differential gene expression data.

We used the query builder to apply several transformations to pre-process the network, including (i) enrichment of

the network with the members of all protein families and protein complexes; (ii) deletion of nodes having the MGI and RGD namespaces that respectively correspond to genes from mice and rats; (iii) removing pathology nodes, which often are uninformative hubs in disease-specific networks; and (iv) extracting only causal edges. Finally, we submitted the query and visualized the network.

The biological network explorer showed that there were several disconnected components in the resulting network. Further, there were several cases where the gene, RNA or protein, such as the GABRA4 gene and RNA, were in different components. We used the tool box above the explorer to apply an additional filter, 'Enrich Protein And RNA Origins', which added the corresponding RNA for each protein then the corresponding gene for each ribonucleic acid/micro-ribonucleic acid (RNA/miRNA) in the network. Finally, we applied 'Collapse Variants' and 'Collapse to Genes' to simplify the network by collapsing all corresponding genes, RNAs, proteins and their variants to a single node for use with the heat diffusion workflow.

After clicking the 'Analyze' button above the explorer, we uploaded three differential gene expression analyses corresponding to patients with Alzheimer's disease in three disease stages (i.e. early, moderate and severe) from Blalock *et al.* [GSE28146, (56)] pre-processed with GEO2R (57). We applied the heat diffusion workflow to the previously generated network using each of the three differential gene expression analyses in parallel and displayed the results (i.e. the final heat on each biological process in the network) together with the parallel coordinate display in BEL Commons (Figure 5). Because each biological process has a final heat corresponding to experiments for the three disease stages, the parallel plot directly allows interpretation of progression patterns. We used BEL Commons to apply a K-Means clustering with $K = 5$ to assist in identifying clusters of biological processes with similar progression patterns and color them accordingly. In Figure 5, biological processes in *group 0* (blue) tended to decrease only at severe onset of disease (e.g. glial cell differentiation). Conversely, biological processes in *group 1* (orange) tended to increase throughout progression of disease (e.g. Notch signaling pathway). Finally, *group 2* (green) processes remained relatively unchanged (e.g. lipid metabolic process) through the progression of disease and *group 4* (purple) remained consistently elevated (e.g. apoptotic process). The complete results of this experiment as well as a tutorial for reproduction can be found in the Supplementary Data.

While BEL has inherent limits in its temporal expressivity, using temporal data in analysis is an initial attempt to overcome these limits. Complex diseases like Alzheimer's



Figure 5. A parallel coordinate plot of the final heats from biological processes from several Alzheimer's disease-specific networks after running the heat diffusion workflow with differential gene expression data from Blalock *et al.* (56) comparing patients at three stages of Alzheimer's disease.

disease must be studied with respect to its progression over time, and we believe that workflows like the one presented above could begin to provide insight to the genesis and progression of the disease in order to support patient stratification and precision medicine.

Discussion

No web application, however feature-rich, will ever satiate the desire and creativity of researchers to generate novel solutions to scientific problems. Even though BEL Commons has taken inspiration from many well-constructed services to build a knowledge discovery environment that enables researchers to explore knowledge and data in new ways, it still shares this limit. However, we are not discouraged, and we hope to make several improvements to BEL Commons in the future.

We would like to improve the interoperability of BEL Commons and the platform build on BEL itself by integrating open authentication systems like Open Researcher and Contributor Identifier (ORCID) (<https://orcid.org>) in order to harmonize identification of users across multiple web services and provide reliable provenance for networks, queries and analyses. We would also like to integrate further tools for converting BEL to Resource Description Framework

(RDF) in order to connect BEL with other linked data. Further, we would like to improve exporters to other services, notably, NDEX, which have brighter outlooks on sharing and feedback systems. Recent developments in integrating Integrated Network and Dynamical Reasoning Assembler (INDRA) (58) with PyBEL enable conversion from BioPAX documents to BEL. A future update to BEL Commons will include an option to upload these documents as well.

We would like to integrate BEL Commons with other BEL-specific systems developed with different underlying technologies. First, integrating the BELIEF Dashboard to use the underlying network and edge store from PyBEL would enable a more thorough feedback and curation interface so users could not only vote on the correctness of edges, but also fix them directly. Second, the NeuroMMSig Mechanism Enrichment Server will be re-implemented completely with reusable PyBEL code and BEL Commons components in order to advance its goals of achieving patient stratification by using common algorithms and tools.

Conclusion

Along with recent improvements in generation of BEL content through text mining (INDRA) and serialization

of resources (Bio2BEL project, <https://github.com/bio2bel>), we believe that BEL Commons will make BEL more accessible to both academic and industrial users. We have made this application freely available at <https://bel-commons.scai.fraunhofer.de>.

Authors' contributions

C.T.H. and D.D.F. conceived the web application, implemented it and wrote this manuscript. M.H.A. reviewed the content.

Supplementary data

Supplementary data are available at Database Online.

Acknowledgements

We would like to thank all colleagues who assisted in testing and provided feedback in order to improve this work, especially to André Gemünd for his technical assistance. We would also like to thank Scott Colby for making our logos.

Funding

European Union / European Federation of Pharmaceutical Industries and Associations (EU/EFPIA) Innovative Medicines Initiative Joint Undertaking under AETIONOMY [grant number 115568], resources of which are composed of financial contribution from the European Union's Seventh Framework Programme (FP7/2007-2013) and EFPIA companies in kind contribution.

Conflict of interest. None declared.

References

- Demir,E., Cary,M.P., Paley,S. *et al.* (2010) The BioPAX community standard for pathway data sharing. *Nat. Biotechnol.*, **28**, 1308.
- Hucka,M., Bergmann,F.T., Hoops,S. *et al.* (2015) The Systems Biology Markup Language (SBML): language specification for level 3 version 1 core. *J. Integr. Bioinform.*, **12**, 382–549.
- Le Novère,N., Hucka,M., Mi,H. *et al.* (2009) The systems biology graphical notation. *Nat. Biotechnol.*, **27**, 735–741.
- Slater,T. (2014) Recent advances in modeling languages for pathway maps and computable biological networks. *Drug Discov. Today*, **19**, 193–198.
- Saqi,M., Lysenko,A., Guo,Y.-K. *et al.* (2018) Navigating the disease landscape: knowledge representations for contextualizing molecular signatures. *Brief. Bioinformatics*, 1–15.
- Valenzuela-Escárcega,M.A., Hahn-Powell,G., Hicks,T. *et al.* (2015) A domain-independent rule-based framework for event extraction. In: Proceedings of ACL-IJCNLP 2015 System Demonstrations, 127–132.
- Allen,J.F., Swift,M. and De Beaumont,W. (2008) Deep semantic analysis of text. In: Proceedings of the 2008 Conference on Semantics in Text Processing STEP 08, **1**, 343–354.
- Björne,J., Heimonen,J., Ginter,F. *et al.* (2011) Extracting contextualized complex biological events with rich graph-based feature sets. *Comput. Intell.*, **27**, 541–557.
- Novichkova,S., Egorov,S. and Daraselia,N. (2003) MedScan, a natural language processing engine for MEDLINE abstracts. *Bioinformatics*, **19**, 1699–1706.
- Madan,S., Hodapp,S., Senger,P. *et al.* (2016) The BEL information extraction workflow (BELIEF): evaluation in the BioCreative V BEL and IAT track. *Database*, **2016**, 1–17.
- Ravikumar,K.E., Rastegar-Mojarad,M. and Liu,H. (2017) BELMiner: adapting a rule-based relation extraction system to extract biological expression language statements from bio-medical literature evidence sentences. *Database*, **2017**, 1–12.
- Lai,P.T., Lo,Y.Y., Huang,M.S. *et al.* (2016) BelSmile: a biomedical semantic role labeling approach for extracting biological expression language from text. *Database*, **2016**, 1–9.
- Rastegar-Mojarad,M., Komandur Elayavilli,R. and Liu,H. (2016) BELTracker: evidence sentence retrieval for BEL statements. *Database*, **2016**, 1–11.
- Guryanova,S. and Guryanova,A. (2017) sbv IMPROVER: modern approach to systems biology. *Methods Mol. Biol.*, **1613**, 21–29.
- Madan,S., Hodapp,S. and Fluck,J. (2015) BELIEF dashboard—a web-based curation interface to support generation of BEL networks. In: Proceedings of the Fifth BioCreative Challenge Evaluation Workshop, 409–417.
- Slenter,D.N., Kutmon,M., Hanspers,K. *et al.* (2017) WikiPathways: a multifaceted pathway database bridging metabolomics to other omics research. *Nucleic Acids Res.*, **46**, D661–D667.
- Chou,C.H., Shrestha,S., Yang,C.D. *et al.* (2017) miRTarBase update 2018: a resource for experimentally validated microRNA-target interactions. *Nucleic Acids Res.*, **46**, D296–D302.
- Davis,A.P., Grondin,C.J., Johnson,R.J. *et al.* (2016) The comparative toxicogenomics database: update 2017. *Nucleic Acids Res.*, **45**, D972–D978.
- Kanehisa,M., Furumichi,M., Tanabe,M. *et al.* (2016) KEGG: new perspectives on genomes, pathways, diseases and drugs. *Nucleic Acids Res.*, **45**, D353–D361.
- Cerami,E.G., Gross,B.E., Demir,E. *et al.* (2010) Pathway Commons, a web resource for biological pathway data. *Nucleic Acids Res.*, **39**, D685–D690.
- Pratt,D., Chen,J., Welker,D. *et al.* (2015) NDEx, the network data exchange. *Cell Syst.*, **1**, 302–305.
- Bharadwaj,A., Singh,D.P., Ritz,A. *et al.* (2017) GraphSpace: stimulating interdisciplinary collaborations in network biology. *Bioinformatics*, **33**, 3134–3136.
- Kutmon,M., van Iersel,M.P., Bohler,A. *et al.* (2015) PathVisio 3: an extendable pathway analysis toolbox. *PLoS Computational Biol.*, **11**, e1004085.
- Shannon,P., Markiel,A., Owen,O. *et al.* (2003) Cytoscape: a software environment for integrated models of biomolecular interaction networks. *Genome Res.*, **13**, 2498–2504.
- Franz,M., Lopes,C.T., Huck,G. *et al.* (2015) Cytoscape.js: a graph theory library for visualisation and analysis. *Bioinformatics*, **32**, 309–311.

26. Khatri,P., Sirota,M. and Butte,A.J. (2012) Ten years of pathway analysis: current approaches and outstanding challenges. *PLoS Comput. Biol.*, **8**.
27. Merico,D., Isserlin,R., Stueker,O. *et al.* (2010) Enrichment Map: a Network-Based Method for Gene-Set Enrichment Visualization and Interpretation. *PLoS ONE*, **5**(11): e13984.
28. Cavalli,F.M.G., Remke,M., Rampasek,L. *et al.* (2017) Intertumoral heterogeneity within medulloblastoma subgroups. *Cancer Cell*, **31**, 737–754.e6.
29. Subramanian,A., Tamayo,P., Mootha,V.K. *et al.* (2005) Gene set enrichment analysis: a knowledge-based approach for interpreting genome-wide expression profiles. *Proc. Natl Acad. Sci. U S A*, **102**, 15545–15550.
30. Liberzon,A., Subramanian,A., Pinchback,R. *et al.* (2011) Molecular signatures database (MSigDB) 3.0. *Bioinformatics*, **27**, 1739–1740.
31. Domingo-Fernández,D., Kodamullil,A.T., Iyappan,A. *et al.* (2017) Multimodal mechanistic signatures for neurodegenerative diseases (NeuroMMSig): a web server for mechanism enrichment. *Bioinformatics*, **33**, 3679–3681.
32. Catlett,N.L., Bargnesi,A.J., Ungerer,S. *et al.* (2013) Reverse causal reasoning: applying qualitative causal knowledge to the interpretation of high-throughput data. *BMC Bioinformatics*, **14**, 340.
33. Martin,F., Thomson,T.M., Sewer,A. *et al.* (2012) Assessment of network perturbation amplitudes by applying high-throughput data to causal biological networks. *BMC Syst. Biol.*, **6**, 54.
34. Hoyt,C.T., Konotopez,A. and Ebeling,C. (2018) PyBEL: a computational framework for Biological Expression Language. *Bioinformatics*, **34**, 703–704.
35. Alon,U. (2007) Network motifs: theory and experimental approaches. *Nat. Rev. Genet.*, **8**, 450–461.
36. Li,J.M., Hu,P.P., Shen,X. *et al.* (1997) E2F4-RB and E2F4-p107 complexes suppress gene expression by transforming growth factor beta through E2F binding sites. *Proc. Natl. Acad. Sci. U S A*, **94**, 4948–4953.
37. Kohn,K.W. (1999) Molecular interaction map of the mammalian cell cycle control and DNA repair systems. *Mol. Biol. Cell*, **10**, 2703–2734.
38. Boué,S., Talikka,M., Westra,J. *et al.* (2015) Causal biological network database: a comprehensive platform of causal biological network models focused on the pulmonary and vascular systems. *Database*, **2015**, bay030.
39. Finn,R.D., Attwood,T.K., Babbitt,P.C. *et al.* (2016) InterPro in 2017—beyond protein family and domain annotations. *Nucleic Acids Res.*, **45**, D190–D199.
40. Gasteiger,E., Gattiker,A., Hoogland,C. *et al.* (2003) ExpASY: the proteomics server for in-depth protein knowledge and analysis. *Nucleic Acids Res.*, **31**, 3784–3788.
41. Placzek,S., Schomburg,I., Chang,A. *et al.* (2017) BRENDA in 2017: new perspectives and new tools in BRENDA. *Nucleic Acids Res.*, **45**, D380–D388.
42. Morgat,A., Lombardot,T., Axelsen,K.B. *et al.* (2017) Updates in Rhea—an expert curated resource of biochemical reactions. *Nucleic Acids Res.*, **45**, D415–D418.
43. Maglott,D., Ostell,J., Pruitt,K.D. *et al.* (2011) Entrez gene: gene-centered information at NCBI. *Nucleic Acids Res.*, **39**, 52–57.
44. Blake,J.A., Eppig,J.T., Kadin,J.A. *et al.* (2017) Mouse Genome Database (MGD)-2017: community knowledge resource for the laboratory mouse. *Nucleic Acids Res.*, **45**, D723–D729.
45. Shimoyama,M., De Pons,J., Hayman,G.T. *et al.* (2015) The Rat Genome Database 2015: genomic, phenotypic and environmental variations and disease. *Nucleic Acids Res.*, **43**, D743–D750.
46. Hebron,M.L., Lonskaya,I. and Moussa,C.E. (2013) Nilotinib reverses loss of dopamine neurons and improves motor behavior via autophagic degradation of alpha-synuclein in Parkinson's disease models. *Hum. Mol. Genet.*, **22**, 3315–3328.
47. Pagan,F., Hebron,M., Valadez,E.H. *et al.* (2016) Nilotinib effects in Parkinson's disease and dementia with Lewy bodies. *J. Parkinsons Dis.*, **6**, 503–517.
48. Duveau,D.Y., Hu,X., Walsh,M.J. *et al.* (2013) Synthesis and biological evaluation of analogues of the kinase inhibitor nilotinib as Abl and Kit inhibitors. *Bioorg. Med. Chem. Lett.*, **23**, 682–686.
49. Derkinderen,P., Scales,T.M.E., Hanger,D.P. *et al.* (2005) Tyrosine 394 is phosphorylated in Alzheimer's paired helical filament tau and in fetal tau with c-Abl as the candidate tyrosine kinase. *J. Neurosci.*, **25**, 6584–6593.
50. Hagberg,A.A., Schult,D.A. and Swart,P.J. (2008) Exploring network structure, dynamics, and function using NetworkX. In: Proceedings of the 7th Python in Science Conference (SciPy 2008), (SciPy), 11–15.
51. Schreiber,F., Dwyer,T., Marriott,K. *et al.* (2009) A generic algorithm for layout of biological networks. *BMC Bioinformatics*, **10**, 1–12.
52. Hastings,J., De Matos,P., Dekker,A. *et al.* (2013) The ChEBI reference database and ontology for biologically relevant chemistry: enhancements for 2013. *Nucleic Acids Res.*, **41**, 456–463.
53. Carbon,S., Dietze,H., Lewis,S.E. *et al.* (2017) Expansion of the gene ontology knowledgebase and resources: the gene ontology consortium. *Nucleic Acids Res.*, **45**, D331–D338.
54. Cote,R., Jones,P., Apweiler,R. *et al.* (2006) The Ontology Lookup Service, a lightweight cross-platform tool for controlled vocabulary queries. *BMC Bioinformatics*, **7**, 1–7.
55. Leiserson,M.D.M., Vandin,F., Wu,H.-T. *et al.* (2015) Pan-cancer network analysis identifies combinations of rare somatic mutations across pathways and protein complexes. *Nat. Genet.*, **47**, 106–114.
56. Blalock,E.M., Buechel,H.M., Popovic,J. *et al.* (2011) Microarray analyses of laser-captured hippocampus reveal distinct gray and white matter signatures associated with incipient Alzheimer's disease. *Journal of Chemical Neuroanatomy*. **37**, 62–70.
57. Barrett,T., Wilhite,S.E., Ledoux,P. *et al.* (2013) NCBI GEO: archive for functional genomics data sets—update. *Nucleic Acids Res.*, **41**, D991–D995.
58. Gyori,B.M., Bachman,J.A., Subramanian,K. *et al.* (2017) From word models to executable models of signaling networks using automated assembly. *Mol. Syst. Biol.*, **13**, 954.

Postface

One of the issues of the accessibility of BEL mentioned in Chapter 2 was the ability for users to use previously published algorithms. With a web interface that guides users through applying those algorithms, BEL Commons moves the community closer to overcoming that issue. More generally, BEL Commons enables users who are less familiar with programming to access the BEL ecosystem. BEL Commons acts as a source of BEL content that can be downloaded for downstream applications, such as the knowledge graph embeddings described by [107], using a novel extension to PyBEL's data interchange¹. Finally, the publication motivated several improvements, such as the deeper integration of the PyBEL ecosystem with INDRA [111] in order to support semi-automated curation and enrichment of knowledge graphs as well as the importation of other formats like BioPAX and SBML that are realized in Chapter 4.

In addition to the direct usage of PyBEL described in the postface of Chapter 2, BEL Commons has supported both curators and end-users of BEL in these projects. Following publication, BEL Commons has been made open source at <https://github.com/bel-commons> with several tools for containerization and deployment as scalable microservices using Docker and Docker-Compose. This may lead to even greater uptake, as the original deployment of BEL Commons was hosted on a Fraunhofer server, which may have been disallowed by industrial users.

¹<https://pybel.readthedocs.io/en/latest/reference/io.html>

4 Re-curation and rational enrichment of knowledge graphs in Biological Expression Language

Preface

Following Chapters 2 and 3, which laid the groundwork for handling and exploring knowledge graphs encoded in BEL, the following publication describes the development and application of two workflows for ensuring the quality of knowledge graphs encoded in BEL and enriching these knowledge graphs with semi-automated curation that leverages large-scale information extraction and natural language processing systems. It presents an evaluation and comparison to previous semi-automated curation workflows using the metrics for curation overhead and efficiency described by Rodríguez-Esteban [140].

Reprinted with permission from "Hoyt, C. T. *et al.*. (2019) Re-curation and rational enrichment of knowledge graphs in Biological Expression Language. *Database*, 2019, baz068". Copyright © Hoyt, C. T., *et al.*, 2019.



Original article

Re-curation and rational enrichment of knowledge graphs in Biological Expression Language

Charles Tapley Hoyt^{1,2,*}, Daniel Domingo-Fernández^{1,2},
Rana Aldisi^{1,2}, Lingling Xu^{1,2}, Kristian Kolpeja¹, Sandra Spalek¹,
Esther Wollert¹, John Bachman³, Benjamin M. Gyori³,
Patrick Greene³ and Martin Hofmann-Apitius^{1,2}

¹Department of Bioinformatics, Fraunhofer Institute for Algorithms and Scientific Computing (SCAI), Sankt Augustin 53754, Germany, ²Bonn-Aachen International Center for Information Technology, Rheinische Friedrich-Wilhelms-Universität Bonn, Bonn 53115, Germany, and ³Laboratory of Systems Pharmacology, Harvard Medical School, 200 Longwood Ave, 02115 Boston, MA, USA

*Corresponding author: Tel: +49 2241 14-2268; Fax: +49 2241 14-2656; Email: charles.hoyt@scai.fraunhofer.de

Citation details: Hoyt, C. T., Domingo-Fernández, D., Aldisi, R. *et al.* Re-curation and rational enrichment of knowledge graphs in Biological Expression Language. *Database* (2019) Vol. 2019: article ID baz068; doi:10.1093/database/baz068

Received 31 January 2019; Revised 3 April 2019; Accepted 29 April 2019

Abstract

The rapid accumulation of new biomedical literature not only causes curated knowledge graphs (KGs) to become outdated and incomplete, but also makes manual curation an impractical and unsustainable solution. Automated or semi-automated workflows are necessary to assist in prioritizing and curating the literature to update and enrich KGs. We have developed two workflows: one for re-curating a given KG to assure its syntactic and semantic quality and another for rationally enriching it by manually revising automatically extracted relations for nodes with low information density. We applied these workflows to the KGs encoded in Biological Expression Language from the NeuroMMSig database using content that was pre-extracted from MEDLINE abstracts and PubMed Central full-text articles using text mining output integrated by INDRA. We have made this workflow freely available at <https://github.com/bel-enrichment/bel-enrichment>.

Database URL: <https://github.com/bel-enrichment/results>

Background

The rapid accumulation of unstructured knowledge in the biomedical literature has motivated its structuring and formalization so computers can assist in large-scale

reasoning and interpretation. Several standard formats have been proposed for storing newly structured knowledge, including Systems Biology Markup Language [SBML; (1)], Biological Pathways Exchange Language [BioPAX; (2)],

Biological Expression Language [BEL; (3)] and Gene Ontology Causal Activity Models (4). Accompanying these standards are public repositories containing content generated both in academic and industrial contexts such as the BioModels Database (5), Pathway Commons (6), NDEX (7), Bio2RDF (8), Open PHACTS (9) and BEL Commons (10).

Even though each standard focuses on different aspects of modeling knowledge in systems and networks biology, they all give rise to knowledge graphs (KGs) consisting of biological entities (nodes), their interrelations (edges) and their associated metadata. While KGs have been useful for qualitative modeling of biochemical networks (11, 12), cellular signaling (13–15), gene regulatory pathways and genetic interactions (16, 17), metabolic pathways (18, 19) and other systems biology applications, there are several challenges associated with their use. First, they contain noise arising from curation, from the loss of information due to representation and from normalization of different knowledge representations (20–22). Second, they are generally an incomplete representation of the current state of scientific knowledge due to the large amount of uncured, unstructured knowledge in the literature. Third, they progressively become out of date as scientific experimentation and investigation elucidate new knowledge (23). Finally, they often lack biological contextual information such as organelle, cell, cell line, tissue, organ, phenotype or disease specificity (24, 25).

KGs also suffer from issues in the normalization and mapping of entities. Though interoperability standards and resources like the Minimal Information Required in the Annotation of Models [MIRIAM; (26)] and Identifiers.org (27) have been developed and implemented to promote the semantic interoperability of biological models (and by extension, KGs), curators often encounter concepts that are not present in high-quality, publicly available terminologies and cannot capture the incident knowledge in a semantically meaningful way. These situations require enriching previously existing terminologies or, in some cases, developing new ones. For situations when the appropriate concept/term is unclear, several tools have been developed and made freely available to the community to help curators build semantically interoperable models including the Ontology Lookup Service [OLS; (28)], the Ontology Mapping Service (OxO; <https://www.ebi.ac.uk/spot/oxo>), Zooma (<https://www.ebi.ac.uk/spot/zooma>) and CEDAR Workbench (29). Further, recent work from Domingo-Fernández *et al.* on mapping pathways between major databases (30) and a critical assessment of their overlaps and contradictions (31) has shown that the adoption of standards like MIRIAM has been slow and that while

the syntax of the varying formats used by each database may be correct, their semantic interoperability is still lacking.

Motivation

Accurately structuring and formalizing the unstructured knowledge in the biomedical literature requires careful planning and manual effort from trained curators. The scope of a given project must be defined based on its scientific goals (e.g. to support the interpretation of data, to generate a disease-specific knowledgebase etc.) and limited in its literature content sources (e.g. abstracts, full text, patents etc.) based on a project-specific metric for quality and relevance—both of which are nebulous in description and difficult to generate. The scope must also be limited to certain classes of biological entities, their interrelations and the standard formats that are capable of expressing them. For instance, the entities, relations and formats used during curation are different for protein complex assemblies curated by the Complex Portal (32) and regulatory interactions curated by the Signaling Network Open Resource (33). Similarly, curation guidelines must be defined reflecting these limits. For example, the guidelines of a project designed to model Tau aggregation inhibitors from the chemistry literature might encourage the curators to include direct binding partners of those inhibitors (e.g. GSK-3 β , CDK5 etc.) but explicitly exclude the biological mechanisms through which the inhibitors' targets result in Tau aggregation that would better be curated during a different project focusing on capturing molecular biology from its primary literature. While there is no alternative to proper planning, several semi-automated curation workflows such as BEL information extraction workflow (BELIEF) (34) and the sbv IMPROVER (35) provide assistance by automatically detecting entities and relations for curators to accept or fix in order to increase productivity and enforce correct syntax and semantics. However, these and similar systems are limited in their ability to capture the relevant chemistry and biology, and reversion to manual curation is often necessary. Most issues arise from the complexity of terminology used in domain-specific biology and the heterogeneity of chemical nomenclature in general. Further, compositions of entities and concepts (e.g. there is a flexible and extensible terminology for complexes of proteins, such as the variety of combinations of subunits that form various nicotinic receptors) remain a challenge as natural language used in scholarly articles is constantly evolving. Finally, the issues of insufficient resources and fixed timelines apply to most curation projects, as aptly described by (36).

In the AETIONOMY project (<https://www.aetionomy.eu>), we manually curated NeuroMMSig, an inventory of multiscale and multimodal KGs that capture mechanistic knowledge in the context of neurological disorders (37). We encoded it in BEL because it is appropriate for qualitative causal, correlative and associative relationships between biological entities, processes and measurements across modes and scales. However, it is currently suffering from the issues we have previously described: it has not been assessed for confidence, is becoming outdated and needs to be enriched following a rational approach that best prioritizes the flood of recent literature.

To address this, we have developed and applied two workflows, described in this paper: the first is for re-curating existing BEL documents to ensure their syntactic and semantic correctness in a scenario where there was neither prior syntax validation, curation guidelines for entity nomenclature nor a second curator for achieving inter-annotator agreement. The second is a semi-automated algorithm and reproducible workflow for updating and rationally enriching an existing KG that lessens the burden of identifying relevant literature, reduces the overhead, as defined by Rodríguez-Esteban (36), and generates more, higher quality, relevant content.

We applied these workflows to a selection of KGs in NeuroMMSig and evaluated the curation effort (time) and quality in comparison to purely manual curation and other previously reported semi-automated curation workflows. We increased the number of nodes and edges in the selected KGs respectively by approximately five and seven times while maintaining the specificity of the KGs. With an improvement to the content underlying NeuroMMSig, the mechanism enrichment algorithm on its corresponding web service can return more correct and robust results to support the analysis of neuroimaging and genomics data for clinical trials in Alzheimer's disease, Parkinson's disease and epilepsy. Finally, we have made this workflow freely available at <https://github.com/bel-enrichment/bel-enrichment> so others can include it in their own curation workflows.

Methods

We first present the re-curation workflow for syntactic and semantic quality assurance before presenting our proposed approach for updating and rational enrichment.

Syntactic quality assurance

We developed a workflow using git (<https://git-scm.com>), GitHub (<https://github.com>), PyBEL (44) and a novel PyBEL extension PyBEL-Git (39) in order to identify and

address syntactical issues in the BEL documents generated during the AETIONOMY project [<https://www.aetionomy.eu>; (40–44)] and exposed through the NeuroMMSig mechanism enrichment server (37).

This workflow can be implemented in other web-based version control systems such as GitLab (<https://gitlab.com>) and Atlassian BitBucket (<https://bitbucket.org>) as well as directly integrated with continuous integration systems such as GitLab CI/CD (<https://docs.gitlab.com/ee/ci>), Travis-CI (<https://travis-ci.com>) and BitBucket Pipelines (<https://bitbucket.org/product/features/pipelines>) using the instructions provided at <https://github.com/pybel/pybel-git> with minimal configuration.

Semantic quality assurance

We selected 10 signatures (and their corresponding BEL documents) from NeuroMMSig based on their druggability (number of proteins targeted by drugs that have been assessed in clinical trials), their novelty (less preference given to subgraphs corresponding to hypotheses that have repeatedly failed in the clinic, namely amyloid-beta aggregation) and their amenability to assay development (based on expert advice) as an example for the re-curation workflow outlined below. An enumeration and statistics can be found in Table 1, and the signatures can be explored through BEL Commons. Because BEL was developed by the biomarker discovery company Selventa before the wide adoption of semantic resources like Identifiers.org, the Open Biomedical Ontology Foundry and the OLS, the language used a custom format for storing the names and identifiers of entities in major biomedical databases and ontologies such as the HUGO Genome Nomenclature Consortium [HGNC; (45)], Chemical Entities of Biological Interest [ChEBI; (46)], the Gene Ontology [GO; (4)], Medical Subject Headings [MeSH; (47)], the Disease Ontology [DO; (48)], the Human Phenotype Ontology [HPO; (49)], the Cell Line Ontology (50), the Experimental Factor Ontology (51) and others. Additionally, Selventa provided several entity type-specific, manually curated terminologies for chemicals, protein families, protein complexes and diseases for entities that had not yet been included in any of the other existing resources.

Because the Selventa terminologies are no longer maintained and the publicly available terminologies have far surpassed them in coverage, the first step in re-curation was to normalize entities to high-quality, publicly available terminologies. For example, chemicals were normalized to identifiers from ChEBI, ChEMBL (52) and PubChem (53) whenever possible; protein families and complexes were normalized to FamPlex (54); and diseases were normalized to DO and HPO. Further, because the BEL documents from

Table 1. Statistics for the number of BEL nodes and BEL statements in the 10 KGs selected from the NeuroMMSig inventory before re-curation (using the version last updated on 6 December 2016), after re-curation and after enrichment

Label	Description	Before re-curation		After re-curation		After enrichment	
		Nodes	Edges	Nodes	Edges	Nodes	Edges
Tau protein subgraph	The downstream effects of the post-translational modification, aggregation and transport of the Tau protein	191	493	261	733	708	2054
DKK1 subgraph, GSK3 subgraph	The interaction partners with GSK-3 β and its targets of post-translational modification. The complementary DKK1 pathway is a specific signaling cascade upstream of GSK-3 β	128	254	174	377	376	1165
Inflammatory response	Processes related to inflammation in the context of Alzheimer's disease	182	373	341	743	2003	7607
Insulin signal transduction	The molecular relationships between insulin resistance and inflammation, motivated by epidemiological studies that suggested a correlation between Alzheimer's disease (AD) and type II diabetes (55).	251	739	315	881	612	1973
Amyloidogenic subgraph	The downstream effects of the amyloid precursor protein (APP), its protein modifiers and its cleavage products	493	1223	652	1751	2090	7436
Non-amyloidogenic subgraph	Chemicals and processes known to down-regulate the expression of the transcript corresponding to APP or the abundance of the APP protein	195	359	325	635	795	2238
Apoptosis and cell death	Processes relevant to AD that result in apoptosis including the Caspase subgraph, XIAP subgraph and Complement system subgraph	104	143	170	229	1065	2401
Acetylcholine subgraph	Pathways including biological entities and processes related to cholinergic neurons and acetylcholine transmission	106	197	148	337	423	1275
GABA subgraph	Pathways including biological entities and process related to GABAergic neurons and GABA transmission	21	30	91	190	305	721
Reactive oxygen species subgraph	The effects of reactive oxygen species, including the Myeloperoxidase subgraph, Hydrogen peroxide subgraph, Free radical formation subgraph and Nitric oxide subgraph	104	173	126	224	1401	6277
Total		1188	3529	1704	5391	5850	23 811

Later, we discuss these statistics in terms of INDRA statements—the discrepancies are due to the ontological reasoner applied in the conversion process from INDRA statements to BEL statements.

Table 2. Confidence annotations using the Likert scale for re-curation

Confidence	Rationale
None	If the evidence string is nonsense or contains no reasonable biological knowledge, delete it and the related statements entirely. It is okay to remove BEL statements that are not supported.
Low	If it's not clear what BEL should represent the biology, add SET Confidence = "Low" for later discussion.
Medium	If the statement is wrong, fix it and add the annotation SET Confidence = "Medium".
High	If statement can be asserted from the given evidence, add the annotation SET Confidence = "High".

AETIONOMY were all produced before 2015, the entities that were curated using their labels (instead of stable identifiers) needed to be updated. A short investigation showed that HGNC and GO were the least stable namespaces (e.g. change of preferred label, splitting of entries, merging of entries and deprecation of entries), but combined they had less than 100 entities to be addressed. We therefore concluded that manual intervention was more appropriate than developing complicated systems for updating labels. While it is not intended to be the focus of this article, we have also begun to build a custom terminology (available at <https://github.com/pharmacome/terminology>) to supplement the publicly available ones for a small number (less than 1000) of terms that had not been included in other resources.

After ensuring both the correctness of BEL syntax and namespace usage, a remaining major aspect of re-curation is to address the issues arising from curation lacking inter-annotator agreement. BEL statements and their corresponding annotations (metadata) were generated by several independent curators and had not undergone quality control either by comparison with the results of independent curation of the same document by a second curator or even minimally checked by a second curator. We applied the following simple guidelines:

1. Second curator: check and label all relevant statements with a SET Confidence annotation using the Likert scale as described in Table 2.
2. Third curator (curation leader): after all relevant statements had been checked for correctness, check all statements with SET Confidence = "High" or SET Confidence = "Medium". Change the confidence to SET Confidence = "Very High" on agreement. Otherwise, fix the statement.

The existence of the confidence guideline can be checked with the PyBEL command line interface with the following command: `pybel compile --required-annotations "Confidence"`.

Proposed approach for updating and rational enrichment

Next, we developed and applied a procedure for enriching a given BEL document in order to cope with the mounting issues of out of dateness and incompleteness. Our approach identifies nodes with low information density and uses a large-scale corpus of biomedical literature that has been pre-processed by automated relation extraction methods to identify the most relevant literature, evidences and ultimately relations. Notably, the previously described quality assurance (i.e. re-curation) workflows for checking and addressing the syntactic and semantic correctness of a given BEL document were necessary to decrease the noise input into the procedure. Following the re-curation of the 10 NeuroMMSig subgraphs, we applied the following procedure for rational enrichment:

1. KG pre-processing: nodes corresponding to the same gene (i.e. RNA, microRNA, protein and variants thereof) are collapsed, non-causal relationships (e.g. correlative, associative, ontological etc.) are removed and several entity types (i.e. abundances, reactions, pathologies and biological processes) are removed. While non-causal relations may be useful for exploration and in some analyses of a KG, their removal results in a graph of genes and their causal interrelations that allow the following enrichment steps to prioritize genes based on the amount of causal information available, which is required for several standard algorithms for analyzing experimental data such as Reverse Causal Reasoning (56). Further, the removal of other entity types and the collapsing of genes and their corresponding products were motivated by the focus of such algorithms on interactions between genes and their products. These pre-processing steps could be modified to fit other downstream applications. For example, the entity filter could be modified to include reactions and metabolites if the downstream application were to investigate metabolic flux.

2. Application of information density metric: the remaining nodes are ranked by an information density function. We used the sum of the node in-degree and out-degree as this corresponds to the amount of causal information for a given gene that is available in the KG. In this scenario, isolated nodes correspond to genes for which there is no causal information about its interactions with other proteins, and leaves (i.e. entities with only one edge) correspond to nodes that have very limited information.
3. Automated relation extraction: the top-ranked genes are used as a query to a KG generated by large-scale automated biological relation extraction. We used the Integrated Network and Dynamical Reasoning and Assembler [INDRA; (57)] and applied several filters to find the most relevant and novel relations. First, the relations that were already curated and in the KG were excluded. Second, INDRA was used to calculate a confidence score (between 0.0 and 1.0) for each relation based on evidences from structured databases and the frequency of occurrence of similar statements. Those statements with a low confidence score (<0.80) were removed to increase the precision and therefore reduce the curation overhead. While INDRA integrates relations extracted from multiple reading systems, a corpus of relations from a single machine reading system, such as EVEX, would serve the same purpose (58).
4. Conversion to BEL: different automated relation extraction systems present various information (e.g. entity offsets, events, triggers etc.) in ways that are not amenable to curation. Because INDRA already normalizes this information for several systems to several varieties of the `indra.Statement` Python class, we developed a converter to BEL using PyBEL that can be used directly with the `indra.assemblers.PybelAssembler` Python class. Finally, this information is exported to an Excel sheet with several additional columns for tracking INDRA statement provenance, curator provenance, the correctness of BEL statements, the type of errors found and the changes made to incorrect BEL statements. Examples and links to the full results can be found in the supplementary information. This process often results in the addition of entities that were excluded during KG pre-processing, such as biological processes and pathologies, as well as the inclusion of additional namespaces based on their corresponding priorities encoded in the converter.

For each round of rational enrichment, the procedure was applied to generate several curation sheets corresponding to the lowest information genes. Each row was checked with the following procedure:

1. Place an 'x' in the 'Checked' column.
2. If the BEL statement correctly corresponds to the 'Evidence' column, place an 'x' in the 'Correct' column.
3. Else if the BEL statement can be improved (e.g. assignment of entity types, relation etc.), correct it and place an 'x' in the 'Changed' column and annotate the error type in the 'Error Type' column using a controlled vocabulary (see the [supplementary data](https://github.com/pharmacome/curation/blob/master/indra-errors.rst)). Additional guidelines for categorizing error types can be found at <https://github.com/pharmacome/curation/blob/master/indra-errors.rst>.
4. Else if the BEL statement does not correspond to the 'Evidence' column and cannot be improved, then 'x' should neither be placed in the 'Correct' nor the 'Changed' column.
5. If the 'Evidence' column contains other BEL statements that were not extracted, duplicate the current row's provenance (reference, evidence etc.) and add the additional BEL statements. Place an 'x' in the 'Changed' column but not the 'Correct' column.
6. If there are other BEL statements that can be extracted, make a new line with all of the same provenance information (uuid, reference, evidence etc.) and just place an 'x' in the 'Changed' column.

This procedure was applied iteratively: as the low information density nodes from the first round gained new relations, the KG was expanded and further low information density nodes were added. There are several improvements that could be made to the information density function and prioritization of the resulting extracted statements. For example, relations found by INDRA between low information density nodes and high information density nodes could be prioritized to maintain the scope and focus of a KG.

Results and discussion

While applying the re-curation workflow outlined in [Figure 1](#), we identified large sections of poor-quality curation that had to be removed. Additionally, some evidences in the BEL document that were previously incompletely curated were completed. Re-curation also required the updating of namespaces from the 2015 versions to the most current and necessitated some additional revisions.

To evaluate the enrichment workflow outlined in [Figure 2](#), we defined weekly curation rounds in which each of the 5 curators were tasked to curate the enrichment template generated by INDRA for the first 30 prioritized genes. Curators worked 10 hours per round for 1 month (4 weeks; 1 round per week) to curate BEL statements from a pool of 113 genes. A database of statements

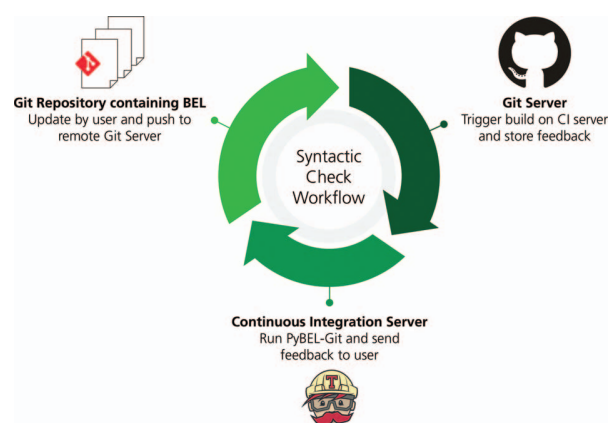

Figure 1. A workflow for syntactic quality assessment. This figure can be found on FigShare at <https://doi.org/10.6084/m9.figshare.7643006.v1>.

was generated by INDRA using the REACH (59, 60) and Sparser (61) readers to extract a total of 17096 statements containing these genes from all MEDLINE abstracts and PubMed Central full-text articles available in August 2018. Of these, 2989 were manually evaluated. A total of 917 statements (30.7%) were marked as correct by the curators, 1454 statements (48.6%) required manual corrections and the remainder (20.7%) could not be corrected. The criteria for correctness was that ‘all’ aspects of the statement, including the subject and object entities, relationship type, phosphorylation and other post-translational modifications, were extracted to the same extent as careful manual curation could. Ultimately, excluding the statements that could not be corrected, 79.3% of the automatically extracted, manually revised BEL statements were recovered. After curation, the recovered statements were converted into a BEL KG that contained 4228 nodes and 17002 edges complementary to the original 10 subgraphs selected from NeuroMMSig. The discrepancies in the number of INDRA statements to BEL statements are due to the ontological reasoning process that occurs during conversion. For example, INDRA statements about protein complex formation are converted to bi-directional BEL statements, INDRA statements about post-translationally modified proteins induce edges to the reference protein and INDRA statements about bound proteins create a variety of additional BEL nodes representing their constituents and membership edges connecting them.

There are two main aspects that are commonly used to formally evaluate a biocuration workflow: the time required to complete the task and quality of the curation compared with a gold standard. To evaluate whether the proposed approach for rational enrichment allows curating a larger amount of statements without compromising the quality, we calculated the average number of min-

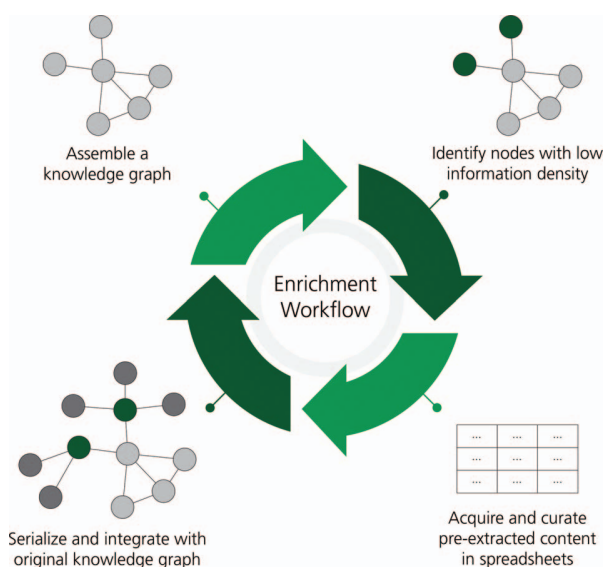

Figure 2. A workflow for the rational enrichment of knowledge graphs. This figure can be found on FigShare at <https://doi.org/10.6084/m9.figshare.7642964.v1>.

utes required to curate one statement using our proposed workflow and compared it with previous estimates calculated conducting manual curation of BEL statements [(34); (62)] (Figure 3a). While the average curation effort was significantly lower than manual curation [2.19 minutes per BEL statement in our workflow vs. 3.2 minutes per BEL statement in manual curation reported by (62)], our calculations included the time used by the curators to annotate the various errors made by the reading system(s). Therefore, if the curation exercise would have exclusively focused on curating BEL statements, the average would have been even lower. Moreover, it is important to note that our proposed approach does not explicitly require the time nor expertise required for corpora generation because the reading systems (e.g. REACH and Sparser) and assembly systems (i.e. INDRA and PyBEL) are applied to all available literature. Unfortunately, it was not possible to make a direct comparison to the reported 1.7 minutes per BEL statement reported by Madan *et al.* (34) due to several confounding variables and the unavailability of further statistical information about the variability of curation time when using BELIEF.

Although the amount of time required to curate a certain amount of statements with the proposed approach is lower compared to standard manual curation, the curation effort is also highly variable depending on which gene was curated (Figure 3a). To investigate how the curation effort depends on the accuracy of the reader extracting BEL statements, we compared the average curation effort between genes whose statements were accurately and poorly extracted (Figure 3b). We observed that the curation effort required

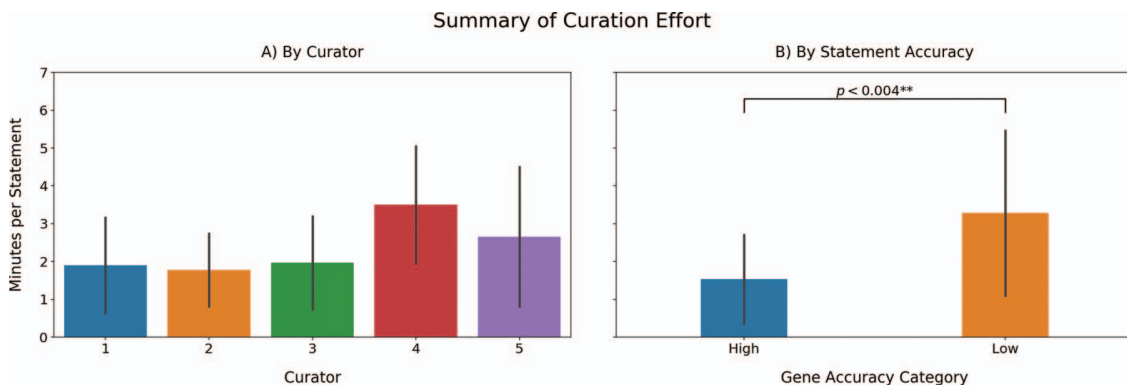

Figure 3. a) Recovered BEL statements per minute. Note that the time reported here includes the time invested in annotate the statement as well as INDRA errors. b) A comparison of the curation effort between genes for which INDRA had high accuracies (top 20) and genes presenting low accuracies (bottom 20).

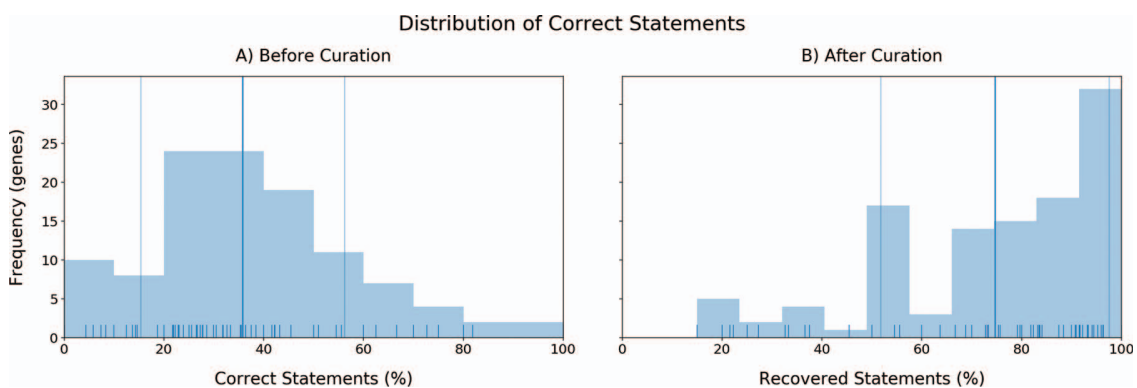

Figure 4. a) The distribution of the accuracies in triple identification by INDRA for each gene. X-axis: Correct statements (%). Y-axis: Number of genes (frequency). b) Distribution of recovered statements after curation (mean: 74.63%).

to extract statements in genes whose statements were highly accurate (top 20) was significantly less ($P < 0.004$; Student's *t*-test) than the effort required to curate low accuracy (bottom 20) genes, which effectively took as long as manual curation. We conclude that the high variability associated with the average curation times per curator can be explained by the extra invested time in the genes presenting low recall.

The second aspect we evaluated was the performance in terms of quality. To investigate the direct quality of the BEL statements coming from INDRA, we analyzed the distributions of correct statements before curation observed in each gene (accuracy investigation) (Figure 4a). Most of the genes presented accuracies close to the mean accuracy (35.75%) with only a few outliers whose limited number of extracted statements lead to their respective high or low accuracies (see Supplementary Figure 1). Furthermore, in accordance with previous research assessing the quality of automatic and manual relation extraction (63), the accuracies we observed again indicated that BEL statements must be manually curated in order to generate high-quality

networks. After curation, the distribution of statements that were correct plus statements that were fixed during curation (i.e. excluding statements that were incorrect and could not be fixed) shifted completely to long-tailed distribution with an average of 74.63% BEL statements successfully extracted (Figure 4b). The remaining statements (~25%) could either not be coded in BEL or contained any relevant information about the particular gene.

While curating the BEL statements, we also annotated the errors made throughout the process of reading, assembly by INDRA and conversion to BEL by PyBEL in order to identify common mistakes and to assist in the improvement of these three systems. The results showed that the most common error is caused by the name entity recognition system that identifies the entities participating in the relation (Figure 5). Other common errors arose from the improper assignment of the subject and object entities, from evidences that did not actually include relations between the subject and object entities and statements that were semantically incorrect due to a negation word (e.g. not, no, none, neither etc.).

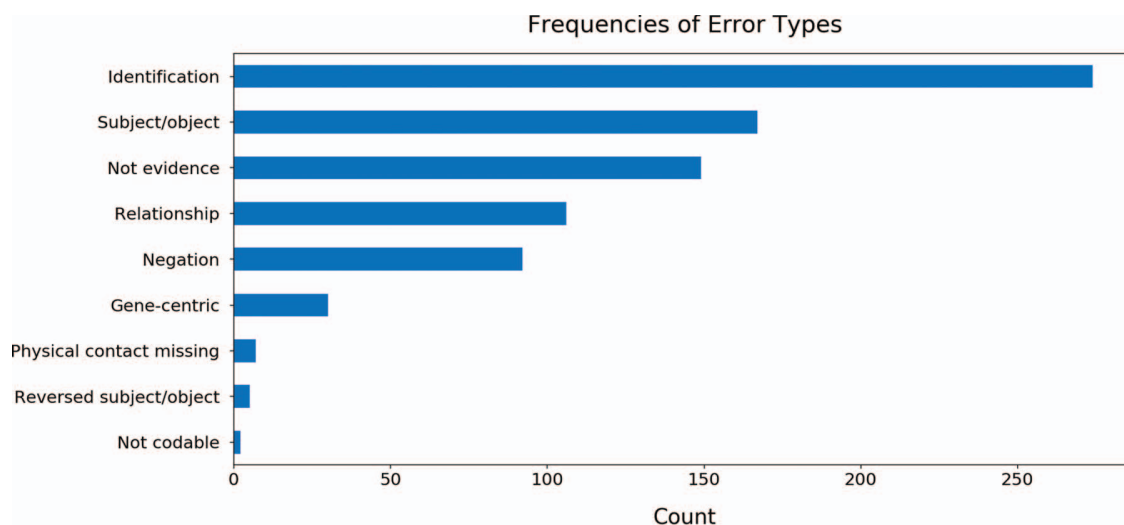

Figure 5. The frequencies of common errors found while curating BEL statements generated from 113 genes. Further details about each error type and the annotation process are available in the guidelines available at <https://github.com/pharmacome/curation/blob/master/indra-errors.rst>.

The five curators were tasked with tagging interesting examples of the common mistakes that could be used to inform the development of the reading systems (REACH, Sparser etc.) and the assembly systems (INDRA and PyBEL). Because the authors of this manuscript maintain the INDRA and PyBEL packages, identifying the causes of errors in assembly was relatively straightforward. For example, BEL statements containing biological processes were consistently output using invalid BEL syntax, including the *activity()* function, which is reserved for proteins and other physical entities. We addressed this by updating the previously mentioned *indra.assemblers.PybelAssembler* class. Another error type that was not addressed until after the evaluation was completed was the determination of the role of direct physical interaction in causal relations. INDRA makes use of linguistic cues from the text mining systems along with information from protein–protein interaction databases to determine if a relation involves a physical interaction between proteins, but this information was not incorporated into the *indra.assemblers.PybelAssembler* class. Instead, by default all relations were output using BEL statements implying physical contact: ‘directly increases’ (i.e. increases via contact) and directly decreases (i.e. decreases via contact). This issue has since been fixed. In general, the direct/indirect distinction is difficult to detect automatically in natural language, though it is very important in the generation of mechanistic and mathematical models arising from biological knowledge.

In Table 3, we present a small sampling of the errors and corresponding suggestions for improvement in the reading systems. We present a much more thorough enumeration

of the errors found in statements for the 113 curated genes in the supplementary information. Besides generating new content quickly, this curation procedure includes information to allow for the evaluation of the automated relation extraction systems and for the proposition of improvements. For example, new groundings can be proposed for entities that were often mismatched. A prominent example was the misidentification of tau (a human protein) and taurine (an amino acid).

Additionally, new rules could be suggested for rule-based systems to avoid issues with the misidentification of the order of the subject and object as in the example of ‘Bak expression was also induced in cells overexpressing the stress-induced transcription factor GADD153, but Bak expression was inhibited in cells expressing an antisense GADD153 construct’ (64) whose use of the passive voice may have caused REACH to interpret the statement as ‘Bak increased GADD153’. Ultimately, we believe we can use these examples to provide useful feedback to the developers of the reading systems and improve future extraction.

After applying the re-curation workflow to our selection of KGs in the NeuroMMSig inventory, we increased the number of nodes from 1188 to 1704 ($\sim 1.5\times$) and edges from 3529 to 5391 ($\sim 1.5\times$). After applying the enrichment workflow, the number of nodes increased to 5850 ($\sim 5\times$) and edges to 23811 ($\sim 7\times$). A more granular summary can be found in Table 1. With a $5\times$ increase in nodes, we would expect to see a $10\times$ increase in edges if the new nodes were completely disconnected from the pre-existing nodes in the KG, which shows that we have been able to maintain the specificity of the KGs to a reasonable degree. In total, our curators spent 80 hours

Table 3. Examples of errors that resulted in suggestions for improvements for the underlying relation extraction systems

Gene	Evidence	Issue	Suggestion
MRC1	In conclusion, these results suggest that BCR and ABL kinase abrogates MMR activity to inhibit apoptosis and induce mutator phenotype. (65)	MRC1, also known as MMR, was confused with mismatch repair (MMR)	Machine learning methods generating contextual word embeddings could be used to improve the named entity recognition component such as NeuralCoref (https://github.com/huggingface/neuralcoref).
TIMP1	In our work, the restoration of cholesterol efflux capacities from EPA-enriched human monocyte-derived macrophages (HMDM) treated with both the adenylate cyclase activator forskolin and the phosphodiesterase inhibitor IBMX strongly suggests that EPA decreased the ABCA1 mediated cholesterol efflux from HMDM through a PKA dependent pathway. (66)	TIMP1, also known as EPA, was confused with eicosapentaenoic acid (EPA)	Improve the named entity recognition (disambiguation) process, for example, by updating synonym dictionaries in rule-based systems.
TRPV1	Moreover, recently TRPV1 has been demonstrated to be either inhibited or activated by PIP 2. (67)	Only the inhibition relationship was extracted	Rule-based relation extraction systems could be appended with new rules to handle sentences with multiple objects. This and similar examples could be included in the training data for machine learning-based relation extraction.
NUMB	This interaction is mediated by the NPXY motif of LNX1 and leads to ubiquitination of Numb by the RING domain of LNX1, thereby targeting Numb to proteasomal degradation. (68)	The complex sentence structure of ‘ubiquitination’ and ‘targeting’ event were not resolved properly, and the ubiquitination was omitted.	Rule-based systems like REACH that explicitly handle ubiquitination events could be appended with new rules.
USF2	Taken together, the results shown in Figure 5A–C suggest that USF2 stimulates the transcriptional activity of NFκB by enhancing the degradation of IκBα. (69)	Relation should be treated as an indirect, rather than direct, increase	Update the INDRA PybelAssembler to make use of information about whether a relation is mediated through physical contact.

on the enrichment step to generate 17 002 new BEL statements with an average rate of 3.54 edges per minute. The resulting enriched KG can be used in reproductions of previous analyses leveraging the NeuroMMSig inventory to assess their robustness, deliver new insights and improve future analyses when the results are incorporated into a future release of the NeuroMMSig mechanism enrichment server. Additionally, the statements comprise a large training set for future machine learning approaches for text mining.

Conclusions

We have proposed and applied a generalizable workflow for enriching and updating existing biological KGs with a focus on the reduction of curation time both in literature triage and in extraction. While its realization involved spreadsheets rather than a *bona fide* curation interface, we believe that it could be adopted by both BEL-specific curation interfaces [e.g. BELIEF and BioDati

Studio (<https://studio.demo.biodati.com>)] and more general biological relation curation interfaces [e.g. NOCTUA (<http://noctua.berkeleybop.org>), Factoid (<https://github.com/PathwayCommons/factoid>) and WikiPathways (70)]. Furthermore, INDRA is flexible enough to generate curation sheets for curators familiar with formats other than BEL, such as BioPAX or SBML.

This workflow is by no means the ultimate solution for finding relevant content. Using pre-extracted statements as a stand-in for relevance allows a given KG to be expanded, but it requires several rounds to find the limits of a given pathway or graph, during which the scope of the curation could be lost. We plan to investigate other methods for identifying relevant content by combining topic modeling with mind maps to not only identify content at the entity level, but on a higher abstraction that allows for capturing of entire areas of biology. These methods could compensate for the simplifications that we made to the curation task, such as removing relations containing chemicals, biological processes and phenotypes. Additionally, they could enable

earlier-stage curation that is more focused on achieving reasonable coverage of the available knowledge rather than high granularity enrichment.

Ultimately, as automated relation extraction technologies improve, they will be used to more significantly supplement manual curation efforts. We expect to see many upcoming workflows leveraging these exciting prospects.

Authors' contributions

C.T.H. and D.D.F. conceived and designed the study and authored this manuscript. C.T.H., D.D.F., R.A., L.X., S.S., E.W. and K.K. performed curation. J.B., B.M.G. and P.G. provided data. M.H.A. supervised the project.

Availability of data and materials

The pybel-git Python package that was used to assess syntactic quality is openly available at <https://github.com/pybel/pybel-git>. All other code and analysis is openly available at <https://github.com/bel-enrichment>.

Supplementary data

Supplementary data are available at *Database* Online.

Acknowledgements

We would like to thank Stephan Gebel for his organizational support and Alina Enns and Keerthika Lohanadan for their help in the curation tasks.

Funding

Fraunhofer Society under the MAVO Project; Human Brain Pharmacome; EU/EFPIA Innovative Medicines Initiative Joint Undertaking under AETIONOMY (115568 to D.D.F.); European Union's Seventh Framework Programme (FP7/2007-2013); EFPIA.

Conflict of interest. None declared.

References

- Hucka,M., Finney,A., Sauro,H.M. *et al.* (2003) The systems biology markup language (SBML): a medium for representation and exchange of biochemical network models. *Bioinformatics*, **19**, 524–531. <https://doi.org/10.1093/bioinformatics/btg015>.
- Demir,E., Cary,M.P., Paley,S. *et al.* (2010) The BioPAX community standard for pathway data sharing. *Nat. Biotechnol.*, **28**, 1308–1308. <https://doi.org/10.1038/nbt1210-1308c>.
- Slater,T. (2014) Recent advances in modeling languages for pathway maps and computable biological networks. *Drug Discov. Today*, **19**, 193–198. <https://doi.org/10.1016/j.drudis.2013.12.011>.
- Carbon,S., Dietze,H., Lewis,S.E. *et al.* (2017) Expansion of the gene ontology knowledgebase and resources: the gene ontology consortium. *Nucleic Acids Res.*, **45**, D331–D338. <https://doi.org/10.1093/nar/gkw1108>.
- Glont,M., Nguyen,T.V.N., Graesslin,M. *et al.* (2018) BioModels: expanding horizons to include more modelling approaches and formats. *Nucleic Acids Res.*, **46**, D1248–D1253. <https://doi.org/10.1093/nar/gkx1023>.
- Cerami,E.G., Gross,B.E., Demir,E. *et al.* (2011) Pathway Commons, a web resource for biological pathway data. *Nucleic Acids Res.*, **39**, 685–690. <https://doi.org/10.1093/nar/gkq1039>.
- Pratt,D., Chen,J., Welker,D. *et al.* (2015) NDEx, the Network Data Exchange. *Cell Systems*, **1**, 302–305. <https://doi.org/10.1016/j.cels.2015.10.001>.
- Belleau,F., Nolin,M.-A., Tourigny,N. *et al.* (2008) Bio2RDF: towards a mashup to build bioinformatics knowledge systems. *J. Biomed. Inform.*, **41**, 706–716. <https://doi.org/10.1016/j.jbi.2008.03.004>.
- Williams,A.J., Harland,L., Groth,P. *et al.* (2012) Open PHACTS: semantic interoperability for drug discovery. *Drug Discov. Today*, **17**, 1188–1198. <https://doi.org/10.1016/j.drudis.2012.05.016>.
- Hoyt,C.T., Domingo-Fernández,D. and Hofmann-Apitius,M. (2018) BEL Commons: an environment for exploration and analysis of networks encoded in Biological Expression Language. *Database (Oxford)*, **2018**, 1–11. <https://doi.org/10.1093/database/bay126>.
- Rausanu,S. *et al.* (2015) Computational models for inferring biochemical networks. *Neural Comput. Appl.*, **26**, 299–311. <https://doi.org/10.1007/s00521-014-1617-x>.
- Yugi,K., Kubota,H., Hatano,A. *et al.* (2016) Trans-omics: how to reconstruct biochemical networks across multiple 'omic' layers. *Trends Biotechnol.*, **34**, 276–290. <https://doi.org/10.1016/j.tibtech.2015.12.013>.
- Pilalis,E., Koutsandreas,T., Valavanis,I. *et al.* (2015) KENeV: a web-application for the automated reconstruction and visualization of the enriched metabolic and signaling super-pathways deriving from genomic experiments. *Comput. Struct. Biotechnol. J.*, **13**, 248–255. <https://doi.org/10.1016/j.csbj.2015.03.009>.
- Pon,A., Jewison,T., Su,Y. *et al.* (2015) Pathways with PathWhiz. *Nucleic Acids Res.*, **43**, W552–W559. <https://doi.org/10.1093/nar/gkv399>.
- Tripathi,S., Flobak,Å., Chawla,K. *et al.* (2015) The gastrin and cholecystokinin receptors mediated signaling network: a scaffold for data analysis and new hypotheses on regulatory mechanisms. *BMC Syst. Biol.*, **9**, 1–15. <https://doi.org/10.1186/s12918-015-0181-z>.
- Kandasamy,K., Mohan,S.S., Raju,R. *et al.* (2010) NetPath: a public resource of curated signal transduction pathways. *Genome Biol.*, **11**, R3. <https://doi.org/10.1186/gb-2010-11-1-r3>.
- Kamburov,A., Stelzl,U., Lehrach,H. *et al.* (2013) The Consensus-PathDB interaction database: 2013 update. *Nucleic Acids Res.*, **41**, 793–800. <https://doi.org/10.1093/nar/gks1055>.
- Caspi,R., Billington,R., Ferrer,L. *et al.* (2016) The MetaCyc database of metabolic pathways and enzymes and the BioCyc collection of pathway/genome databases. *Nucleic Acids Res.*, **44**, D471–D480. <https://doi.org/10.1093/nar/gkv1164>.

19. Wishart,D.S., Feunang,Y.D., Marcu,A. *et al.* (2018) HMDB 4.0: the human metabolome database for 2018. *Nucleic Acids Res.*, **46**, D608–D617. <https://doi.org/10.1093/nar/gkx1089>.
20. Nickel,M., Murphy,K., Tresp,V. *et al.* (2016) A review of relational machine learning for knowledge graphs. *Proc. IEEE*, **104**, 11–33. <https://doi.org/10.1109/jproc.2015.2483592>.
21. Mihindukulasooriya,N., Hassanzadeh,O., Dash,S. *et al.* (2017) Towards comprehensive noise detection in automatically-created knowledge graphs. In: *CEUR Workshop Proceedings*, Vol. 1963, pp. 1–4.
22. Pujara,J., Augustine,E. and Getoor,L. (2017) Sparsity and noise: where knowledge graph embeddings fall short. In: *Conference on Empirical Methods in Natural Language Processing*, pp. 1752–1757.
23. Wadi,L., Meyer,M., Weiser,J. *et al.* (2016) Impact of outdated gene annotations on pathway enrichment analysis. *Nat. Methods*, **13**, 705–706. <https://doi.org/10.1038/nmeth.3963>.
24. Hofmann-Apitius,M., Ball,G., Gebel,S. *et al.* (2015) Bioinformatics mining and modeling methods for the identification of disease mechanisms in neurodegenerative disorders. *Int. J. Mol. Sci.*, **16**, 29179–29206. <https://doi.org/10.3390/ijms161226148>.
25. Saqi,M., Lysenko,A., Guo,Y.-K. *et al.* (2018) Navigating the disease landscape: knowledge representations for contextualizing molecular signatures. *Brief. Bioinform.*, bby025. <https://doi.org/10.1093/bib/bby025>.
26. Laibe,C. and Le Novère,N. (2007) MIRIAM Resources: tools to generate and resolve robust cross-references in Systems Biology. *BMC Syst. Biol.*, **1**, 58. <https://doi.org/10.1186/1752-0509-1-58>.
27. Juty,N., Le Novère,N. and Laibe,C. (2012) Identifiers.org and MIRIAM Registry: community resources to provide persistent identification. *Nucleic Acids Res.*, **40**, 580–586. <https://doi.org/10.1093/nar/gkr1097>.
28. Cote,R., Jones,P., Apweiler,R. *et al.* (2006) The Ontology Lookup Service, a lightweight cross-platform tool for controlled vocabulary queries. *BMC Bioinformatics*, **7**, 1–7. <https://doi.org/10.1186/1471-2105-7-97>.
29. Gonçalves,R.S., O'Connor,M.J., Martínez-Romero,M. *et al.* (2017) The CEDAR workbench: an ontology-assisted environment for authoring metadata that describe scientific experiments. *Lecture Notes in Computer Science*, Vol. 10588, pp. 103–110. https://doi.org/10.1007/978-3-319-68204-4_10.
30. Domingo-Fernández,D., Hoyt,C.T., Bobis Alvarez,C. *et al.* (2018) ComPath: an ecosystem for exploring, analyzing, and curating pathway databases. *NPJ Syst. Biol. Appl.*, **5**, 3. <https://doi.org/10.1038/s41540-018-0078-8>.
31. Domingo-Fernández,D., Mubeen,S., Marín-Llaó,J. *et al.* (2019) PathMe: merging and exploring mechanistic pathway knowledge. *BMC Bioinformatics*, **20**, 243. <https://doi.org/10.1186/s12859-019-2863-9>.
32. Meldal,B.H.M., Forner-Martinez,O., Costanzo,M.C. *et al.* (2015) The complex portal—an encyclopaedia of macromolecular complexes. *Nucleic Acids Res.*, **43**, D479–D484. <https://doi.org/10.1093/nar/gku975>.
33. Peretto,L., Briganti,L., Calderone,A. *et al.* (2016) SIGNOR: a database of causal relationships between biological entities. *Nucleic Acids Res.*, **44**, D548–D554. <https://doi.org/10.1093/nar/gkv1048>.
34. Madan,S., Hodapp,S., Senger,P. *et al.* (2016) The BEL information extraction workflow (BELIEF): evaluation in the BioCreative V BEL and IAT track. *Database (Oxford)*, **2016**, 1–17. <https://doi.org/10.1093/database/baw136>.
35. Guryanova,S. and Guryanova,A. (2017) sbv IMPROVER: modern approach to systems biology. *Methods Mol. Biol.*, **1613**, 21–29. https://doi.org/10.1007/978-1-4939-7027-8_2.
36. Rodriguez-Esteban,R. (2015) Biocuration with insufficient resources and fixed timelines. *Database (Oxford)*, **2015**, 1–9. <https://doi.org/10.1093/database/bav116>.
37. Domingo-Fernández,D., Kodamullil,A.T., Iyappan,A. *et al.* (2017) Multimodal mechanistic signatures for neurodegenerative diseases (NeuroMMSig): a web server for mechanism enrichment. *Bioinformatics*, **33**, 3679–3681. <https://doi.org/10.1093/bioinformatics/btx399>.
38. Hoyt,C.T., Konotopez,A. and Ebeling,C. (2018) PyBEL: a computational framework for Biological Expression Language. *Bioinformatics*, **34**, 703–704. <https://doi.org/10.1093/bioinformatics/btx660>.
39. Hoyt,C.T. (2018) cthoyt/pybel-git v0.0.1 (Version v0.0.1). Zenodo. <http://doi.org/10.5281/zenodo.1491432> (19 November 2018, date last accessed).
40. Irin,A.K., Tom Kodamullil,A., Gündel,M. *et al.* (2015) Computational modelling approaches on epigenetic factors in neurodegenerative and autoimmune diseases and their mechanistic analysis. *J. Immunol. Res.*, **2015**, 1–10. <https://doi.org/10.1155/2015/737168>.
41. Kodamullil,A.T., Younesi,E., Naz,M. *et al.* (2015) Computable cause-and-effect models of healthy and Alzheimer's disease states and their mechanistic differential analysis. *Alzheimers Dement*, **11**, 1329–1339. <https://doi.org/10.1016/j.jalz.2015.02.006>.
42. Naz,M., Kodamullil,A.T. and Hofmann-Apitius,M. (2016) Reasoning over genetic variance information in cause-and-effect models of neurodegenerative diseases. *Brief. Bioinform.*, **17**, 505–516. <https://doi.org/10.1093/bib/bbv063>.
43. Emon,M.A.E.K., Kodamullil,A.T., Karki,R. *et al.* (2017) Using drugs as molecular probes: a computational chemical biology approach in neurodegenerative diseases. *J. Alzheimers Dis.*, **56**, 677–686. <https://doi.org/10.3233/JAD-160222>.
44. Hoyt,C.T., Domingo-Fernández,D., Balzer,N. *et al.* (2018) A systematic approach for identifying shared mechanisms in epilepsy and its comorbidities. *Database (Oxford)*, **2018**, 269860. <https://doi.org/10.1093/database/bay050>.
45. Yates,B., Braschi,B., Gray,K.A. *et al.* (2017) Genenames.org: the HGNC and VGNC resources in 2017. *Nucleic Acids Res.*, **45**, D619–D625. <https://doi.org/10.1093/nar/gkw1033>.
46. Hastings,J., De Matos,P., Dekker,A. *et al.* (2013) The ChEBI reference database and ontology for biologically relevant chemistry: enhancements for 2013. *Nucleic Acids Res.*, **41**, 456–463. <https://doi.org/10.1093/nar/gks1146>.
47. Rogers,F.B. (1963) Medical subject headings. *Bull. Med. Libr. Assoc.*, **51**, 114–116.
48. Schriml,L.M., Mitra,E., Munro,J. *et al.* (2018) Human Disease Ontology 2018 update: classification, content and workflow expansion. *Nucleic Acids Res.*, **47**, D955–D962. <https://doi.org/10.1093/nar/gky1032>.
49. Köhler,S., Carmody,L., Vasilevsky,N. *et al.* (2018) Expansion of the Human Phenotype Ontology (HPO) knowledge base and

- resources. *Nucleic Acids Res.*, 1–10. <https://doi.org/10.1093/nar/gky1105>.
50. Sarnitvijai,S., Lin,Y., Xiang,Z. *et al.* (2014) CLO: the cell line ontology. *J. Biomed. Semantics*, 5, 1–10. <https://doi.org/10.1186/2041-1480-5-37>.
51. Malone,J., Holloway,E., Adamusiak,T. *et al.* (2010) Modeling sample variables with an Experimental Factor Ontology. *Bioinformatics*, 26, 1112–1118. <https://doi.org/10.1093/bioinformatics/btq099>.
52. Gaulton,A., Hersey,A., Nowotka,M.L. *et al.* (2017) The ChEMBL database in 2017. *Nucleic Acids Res.*, 45, D945–D954. <https://doi.org/10.1093/nar/gkw1074>.
53. Kim,S., Thiessen,P.A., Bolton,E.E. *et al.* (2016) PubChem substance and compound databases. *Nucleic Acids Res.*, 44, D1202–D1213. <https://doi.org/10.1093/nar/gkv951>.
54. Bachman,J.A., Gyori,B.M. and Sorger,P.K. (2018) FamPlex: a resource for entity recognition and relationship resolution of human protein families and complexes in biomedical text mining. *BMC Bioinformatics*, 19, 1–14. <https://doi.org/10.1186/s12859-018-2211-5>.
55. Karki,R., Tom Kodumullil,A. and Hofmann-Apitius,M. (2017) Comorbidity analysis between Alzheimer’s disease and type 2 diabetes mellitus (T2DM) based on shared pathways and the role of T2DM drugs. *J. Alzheimers Dis.*, 60, 721–731.
56. Catlett,N.L., Bargnesi,A.J., Ungerer,S. *et al.* (2013) Reverse causal reasoning: applying qualitative causal knowledge to the interpretation of high-throughput data. *BMC Bioinformatics*, 14, 340. <https://doi.org/10.1186/1471-2105-14-340>.
57. Gyori,B.M., Bachman,J.A., Subramanian,K. *et al.* (2017) From word models to executable models of signaling networks using automated assembly. *Mol. Syst. Biol.*, 13, 954. <https://doi.org/10.15252/msb.20177651>.
58. Van Landeghem,S., Hakala,K., Rönnqvist,S. *et al.* (2012) Exploring biomolecular literature with EVEX: connecting genes through events, homology, and indirect associations. *Adv. Bioinformatics*, 2012, 582765. <https://doi.org/10.1155/2012/582765>.
59. Valenzuela-Escárcega,M.A., Hahn-Powell,G., Surdeanu,M. *et al.* (2015) A domain-independent rule-based framework for event extraction. In: *Proceedings of ACL-IJCNLP 2015 System Demonstrations*. Association for Computational Linguistics and the Asian Federation of Natural Language Processing. Stroudsburg, PA, USA pp. 127–132. <https://doi.org/10.3115/v1/P15-4022>.
60. Valenzuela-Escárcega,M.A., Babur,Ö., Hahn-Powell G, *et al.* (2018) Large-scale automated machine reading discovers new cancer-driving mechanisms. *Database (Oxford)*, 2018, 1–14. <https://doi.org/10.1093/database/bay098>.
61. McDonald,D.D. (2000) Issues in the representation of real texts: the design of KRISP. In: *Natural Language Processing and Knowledge Representation*, pp. 77–110. <https://github.com/ddmcdonald/sparser>.
62. Szostak,J., Ansari,S., Madan,S. *et al.* (2015) Construction of biological networks from unstructured information based on a semi-automated curation workflow. *Database (Oxford)*, 2015, bav057, <https://doi.org/10.1093/database/bav057>.
63. Rinaldi,F., Ellendorff,T.R., Madan,S. *et al.* (2016) BioCreative V track 4: a shared task for the extraction of causal network information using the Biological Expression Language. *Database (Oxford)*, 2016, baw067, <https://doi.org/10.1093/database/baw067>.
64. Lovat,P.E., Oliverio,S., Corazzari,M. *et al.* (2003) Bak: a downstream mediator of fenretinide-induced apoptosis of SH-SY5Y neuroblastoma cells. *Cancer Res.*, 63, 7310–7313.
65. Stoklosa,T., Poplawski,T., Koptyra,M. *et al.* (2008) BCR/ABL inhibits mismatch repair to protect from apoptosis and induce point mutations. *Cancer Res.*, 68, 2576–2580.
66. Fournier,N., Tardivel,S., Benoist,J.-F. *et al.* (2016) Eicosapentaenoic acid membrane incorporation impairs ABCA1-dependent cholesterol efflux via a protein kinase A signaling pathway in primary human macrophages. *Biochim. Biophys. Acta*, 1861, 331–341.
67. Morelli,M.B., Amantini,C., Nabissi,M. *et al.* (2014) Cross-talk between alpha 1D-adrenoceptors and transient receptor potential vanilloid type 1 triggers prostate cancer cell proliferation. *BMC Cancer*, 14, 921.
68. Young,P., Nie,J., Wang,X. *et al.* (2005) LNX1 is a perisynaptic Schwann cell specific E3 ubiquitin ligase that interacts with ErbB2. *Mol. Cell. Neurosci.*, 30, 238–248.
69. Wang,L., Li,H., Zhang,Y. *et al.* (2009) HINT1 inhibits β -catenin/TCF4, USF2 and NF κ B activity in human hepatoma cells. *Int. J. Cancer*, 124, 1526–1534.
70. Slenter,D.N., Kutmon,M., Hanspers,K. *et al.* (2018) WikiPathways: a multifaceted pathway database bridging metabolomics to other omics research. *Nucleic Acids Res.*, 46, D661–D667.

Postface

Continuing with the goals of developing the ecosystem around BEL and Py-BEL, the workflows and all resulting manually curated results from this publication have been made freely and openly available to the community. The first workflow for quality control of BEL promotes more sustainable curation practices through the usage of version control systems and continuous integration systems. It was used to re-curate all of the knowledge assemblies from the AETIONOMY project as well as enforce the clean generation of new knowledge during the Human Brain Pharmacome project that can be found at <https://github.com/pharmacome/conib>. Without re-curation, previously generated content may neither be syntactically, semantically, nor biologically correct.

The second workflow allows for the usage of massively extracted content from unstructured text and automated enrichment of knowledge graphs, which further reduces this burden. Ultimately, the usage of these workflows provided significant improvements over both manual curation and previously published state-of-the-art semi-automated curation systems. These improvements manifested across all of the management, planning, and reading aspects of curation. The workflow is scalable because pre-extraction can be done once in bulk, then on a schedule so the most recent content is always available. Further, because curation of each statement is independent, the workflow is scalable with respect to number of curators. Then, between each curation, the priorities of all statements can be updated.

While enrichment can be applied generally to any disease- or pathways-specific knowledge graph, it can also be iterated with topic-driven or publication-driven curation to quickly acquire breadth in new fields.

Finally, the conclusion of this publication noted that a spreadsheet-based curation workflow has the benefit of being simple. Its conceptualization has motivated some improvements to the INDRA Database¹ web application that will likely result in its evolution into a web-based curation application. When interfacing directly with the database, the workflow described in this article can be implemented directly. Other community driven curation tools like WikiPathways and the SBV Improver may be able to draw content from this system or make contributions directly to improve their efficiency.

¹<https://db.indra.bio>

5 Integration of structured biological data sources using Biological Expression Language

Preface

While manual and semi-automated curation can generate focused and context-specific knowledge graphs, high granularity knowledge is sparse and incomplete. The biomedical community comprises many large-scale curation efforts that generate high quality *translational* knowledge graphs with low specificity, but coverage over many organisms, tissues, diseases, and pathways that can be used to complete focused knowledge graphs.

Following the knowledge graph enrichment workflow presented in Chapter 4, this chapter's publication describes the development and application of BEL as a medium for integrating heterogeneous, multi-scale, and multi-modal structured biological data sources due to its ability to represent a wider variety of causal, correlative, and associative relationships than related systems biology modeling languages. Towards this end, numerous independent *Bio2BEL packages* have been developed capable of downloading, structuring, and serializing various biological data sources to BEL as well as an overarching computational framework so that other software developers and biological data source owners can contribute their own Bio2BEL packages.

The philosophy of Bio2BEL encourages reproducibility, accessibility, and democratization of biological data sources. The inclusion of numerous authors across several institutions shows the potential of the Bio2BEL philosophy as well as realizes the goals from Chapter 2 to make the PyBEL ecosystem usable by others.

Reprinted with permission from "Hoyt, C.T., *et al.* (2019). Bio2BEL: Integration of Structured Knowledge Sources with Biological Expression Language. *BMC Bioinformatics, submitted*". Copyright © Hoyt, C.T., *et al.*, 2019.

RESEARCH

Integration of Structured Biological Data Sources using Biological Expression Language

Charles Tapley Hoyt^{1,2*}, Daniel Domingo-Fernández^{1,2}, Sarah Mubeen^{1,2}, Josep Marín-Lláo¹, Andrej Konotopez¹, Christian Ebeling¹, Colin Birkenbihl^{1,2}, Özlem Muslu^{1,2}, Bradley English^{1,2}, Simon Müller^{1,2}, Mauricio Pio de Lacerda², Mehdi Ali^{3,4}, Scott Colby⁵, Denés Türei^{6,7,8}, Nicolàs Palacio-Escat^{7,8} and Martin Hofmann-Apitius^{1,2}

*Correspondence:

charles.hoyt@scai.fraunhofer.de

¹ Department of Bioinformatics, Fraunhofer Institute for Algorithms and Scientific Computing (SCAI), Konrad Adenauer Strasse, 53754 Sankt Augustin, Germany

Full list of author information is available at the end of the article

Abstract

Background: The integration of heterogeneous, multi-scale, and multi-modal knowledge and data has become a common prerequisite for joint analysis to unravel the mechanisms and aetiologies of complex diseases. Because of its unique ability to capture this variety, Biological Expression Language (BEL) is well suited to be further used as a platform for semantic integration and harmonization in networks and systems biology.

Results: We have developed numerous independent packages capable of downloading, structuring, and serializing various biological data sources to BEL. Each Bio2BEL package is implemented in the Python programming language and distributed through GitHub (<https://github.com/bio2bel>) and PyPI.

Conclusions: The philosophy of Bio2BEL encourages reproducibility, accessibility, and democratization of biological databases. We present several applications of Bio2BEL packages including their ability to support the curation of pathway mappings, integration of pathway databases, and machine learning applications.

Keywords: Data Integration; Semantic Web; Biological Expression Language; Knowledge graphs

Background

The integration of heterogeneous, multi-scale, and multi-modal biomedical data has become a cornerstone of modern computational investigation of the mechanisms and aetiologies underlying complex diseases [1, 2, 3, 4, 5]. An overarching strategy was proposed by Davidson *et al.* more than two decades ago that outlined the transformation of data into a common model, semantic alignment of related objects, integration of schemata, and federation of data [6]. However, integration remains a challenging task that requires the identification and deep understanding of biological data sources and their respective formats, conversion, harmonization, and unification.

Initial interest in the semantic web and linked open data along with the adoption of RDF (Resource Description Framework) in the biomedical community led to the Bio2RDF project, in which pipelines for converting and serializing several biological data sources to RDF were developed [7]. Several updates have been issued since its deployment such as the inclusion of chemical information systems [8]. Further, it has also influenced in and has been adopted by subsequent projects such as

Open PHACTS [9]. While RDF is highly expressive and each of these projects have developed and enforced well-defined schemata, the format is often not well-suited for downstream analyses and must first be queried with languages like SPARQL (SPARQL Query Language for RDF) and subsequently be transformed into appropriate formats with general-purpose programming languages. Alternatives to RDF/SPARQL such as property graphs (e.g., Neo4j, OrientDB) are comparable [10] but also necessitate similar post-processing.

Conversely, there have been several biologically meaningful integration efforts (e.g., STRING [11]; GeneMANIA [12]; GeneCards [13]). However, most suffer from a lack of defined schemata or standardized data format that impede biological database interoperability. As interoperability itself is a multifaceted concept, we would like to highlight three of its facets: first, data sources should refer to named entities using high-quality, publicly accessible terminologies as prescribed by the Minimal Information Requested in the Annotation of Biochemical Models standard [14]. Second, data sources should additionally denote the ontological classes of named entities (e.g., gene, transcript, protein, pathway, disease) along with their reference using controlled vocabularies such as the Systems Biology Ontology [15]. Some identifiers, such as those for genes, are often used to refer not only to the physical region of DNA within the genome, but also the corresponding RNA transcript(s) or protein product(s). Unfortunately, many biological databases do not explicitly distinguish between these entity classes. For example, the STRING database lists gene-centric homology relationships, transcript-centric co-expression relationships, and protein-centric protein-protein interactions using gene-centric nomenclature. While it may be possible to identify the classes of entities based on their incident relationships, doing so requires specific knowledge of the database including the semantics of its relationships. Third, resources should, at a minimum, map their relationships to controlled vocabularies such as the Relation Ontology, or further use standardized data formats with defined semantics (e.g., PSI MI-TAB) to minimize both the interpretation and implementation effort when combining them with other resources.

OmniPath [16] began to address these facets when it combined several signaling pathway and transcriptional regulation databases. It achieved interoperability between several databases by normalizing the identifiers and relationships between entities from several databases describing the same phenomena (e.g., microRNA-target interactions, protein-protein interactions, etc.) and creating a unified network. However, because it did not use a standard format or schema as mentioned in the third facet for interoperability, OmniPath itself cannot readily be directly integrated with other biological data sources. Pathway Commons [17] addressed this concern when combining several molecular pathway and interaction databases by translating the source databases into the BioPAX standard [18] using automated pipelines. However, it suffers from low granularity and low recovery of information from some of its primary biological data sources which may be due to prioritization of software development time, data usage restrictions, or shortcomings in the BioPAX standard. While BioPAX is well-suited for representing biological reactions and transformations, it is limited in its ability to represent correlative and associative relationships across multi-scale biology (e.g., at the levels of processes, phenotypes, and clinical observations).

As an alternative, we propose the use of Biological Expression Language (BEL [19]) as an integration schema in order to overcome the limits faced by previous efforts and to simultaneously address all three facets of interoperability. BEL has begun to prove itself as a robust format in the curation and integration of previously isolated biological data sources of high granular information on genetic variation [20], epigenetics [21], chemogenomics [22], and clinical biomarkers [23]. Its syntax and semantics are also appropriate for representing, for example, disease-disease similarities, disease-protein associations, chemical space networks, genome-wide association studies, and phenome-wide association studies.

With the same focus on reproducibility as Bio2RDF, OmniPath, and Pathway Commons as well as deference to software maintainability and the ease of development and inclusion of new biological data sources, we have developed a growing list of Bio2BEL packages, each capable of downloading, structuring, and serializing various biological data sources to BEL (Table 4). Each can be found in the Bio2BEL GitHub organization (<https://github.com/bio2bel>) as an independent open-source Python package that can readily be installed with pip. We have also developed and freely provided a framework (<https://github.com/bio2bel/bio2bel>) in the Python programming language to enable code reuse and the fast generation of additional Bio2BEL packages. Notably, the list of Bio2BEL packages includes one for OmniPath as a proof of concept that authors of other resources can implement their own Bio2BEL packages. In this article, we present the philosophy and implementation of Bio2BEL packages, a summary of past and future Bio2BEL packages, and finally, several case studies including the utility of Bio2BEL packages during curation of pathway mappings, in the analysis of cancer genome data, and for machine learning applications.

Implementation

Bio2BEL comprises numerous independent open-source Python packages that each enable reproducible access to a given biological data source (Figure 1). Each Bio2BEL package contains five components: 1) a definition of the source database or knowledge base, 2) an automated downloader for the data, 3) a parser for the data, 4) a storage and querying system for the data, and 5) a protocol for serializing the data to BEL (Figure 2). In this section, we outline the components of a Bio2BEL package and their implementation details.

Components of a Bio2BEL package

As this section outlines the core components and philosophy of a Bio2BEL package, it illustrates the tasks and thought process of a scientific software developer as they implement a new Bio2BEL package.

Definition of data

The first step in generating a Bio2BEL package is to understand the source data. This requires determining if the data are publicly accessible, if they are versioned (and how the location changes with versions), and if they are available under a permissive license. Bio2BEL packages do not contain data themselves and only refer to the locations of the original data sources. For those that are versioned,

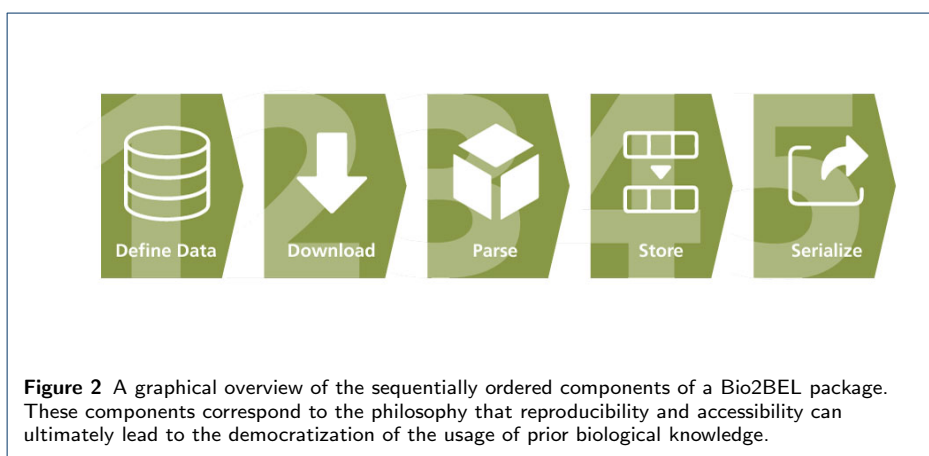
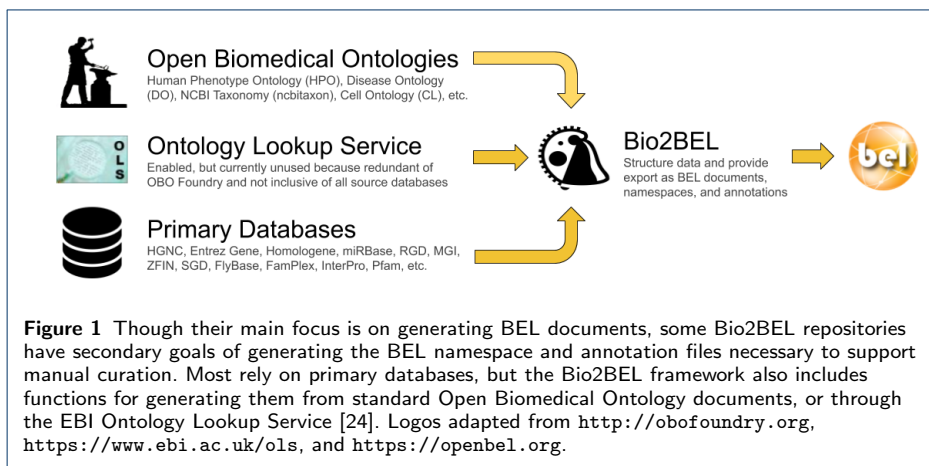

providers commonly generate symlinks to the most recent version (e.g., InterPro; <ftp://ftp.ebi.ac.uk/pub/databases/interpro>). These characteristics help minimize licensing issues while enabling the resulting packages to update their content without changing code. Then, the developer implements custom code that makes the appropriate interpretations to convert the source data to BEL. Below, three types of data that can be readily integrated in BEL are described along with accompanying Table 1, 2, and 3.

Table 1 Taxonomies, Hierarchies, and Ontologies

Data Source	Example BEL Statement	Description
MeSH	<code>path(X) isA path(Y)</code>	Pathology X is a subtype of pathology Y.
Complex Portal	<code>p(X) partOf complex(Y)</code>	Protein X is a member of complex Y.
GO	<code>bp(X) partOf bp(Y)</code>	Biological process X is a sub-process of Y.

Table 2 Tabular and Relational Data

Data Source	Example BEL Statement	Description
PubChem, ChEMBL	<code>a(X) directlyDecreases act(p(Y), ma(kin))</code>	Compound X inhibits kinase Y.
ADEPTUS	<code>path(X) positiveCorrelation r(Y)</code>	Gene Y is up-regulated in patients with pathology X.
ADEPTUS	<code>path(X) negativeCorrelation r(Y)</code>	Gene Y is down-regulated in patients with pathology X.
ADEPTUS	<code>path(X) causeNoChange r(Y)</code>	Gene Y is not regulated in patients with pathology X.

Table 3 Graphs

Data Source	Example BEL Statement	Description
Menche <i>et al.</i>	path(X) association path(Y)	Pathology X is statistically similar to pathology Y

Taxonomies, hierarchies, and ontologies The Medical Subject Headings [25] multi-hierarchy can be converted to BEL by generating an isA relationship between each MeSH descriptor and all of its corresponding parents in the associated MeSH tree. Nomenclatures like the Complex Portal [26] also define partOf relations between protein complexes and their substituents. The multi-hierarchy in Gene Ontology (GO [27]) can be converted similarly, which contains both isA relations and partOf relations.

Tabular and Relational Data Enzyme inhibitors from ChEMBL and PubChem can be encoded like a(X) directlyDecreases act(p(Y), ma(kin)), and disease-specific differential gene expression can be encoded like path(X) positiveCorrelation r(Y) or path(X) negativeCorrelation r(Y), or path(X) causeNoChange r(Y) depending on whether the gene's expression is up-regulated, down-regulated, or not regulated, respectively. Further, BEL relationships can be extended include metadata (i.e., annotations) describing their quantitative aspects. For example, IC_{50} , EC_{50} , or other kinetic assay measurements as well as provenance and biological contextual information (e.g., original publication, cell line, assay type) can be included with the enzyme inhibition relationships from ChEMBL. Similarly, the log_2 fold change and p -values can be included with relationships about differential gene expression.

Graphs Wet-laboratory experimentation can be used to generate networks of directly observed phenomena (e.g., protein-protein interaction networks) and indirectly observed phenomena (e.g., gene co-expression networks). Graphs are often distributed as tabular data to include additional information about their constituent nodes and edges and there is often overlap with the previous data type describing tabular and relational data. *In silico* experimentation can also be used to derive edges from experimental data sets or even other graphs. For instance, bipartite graphs can be projected to homogeneous graphs consisting of a single entity and edge type as suggested by Sun *et al.* [28]. Menche *et al.* [29] used this strategy and computed a homogenous graph of disease-disease associations from a bipartite graph of diseases and their associated genes.

Downloader

The Bio2BEL framework follows a functional programming paradigm to provide an abstraction of the acquisition of data over common internet protocols like HTTP, HTTPS, and FTP. With only the URL of the data set as an input, Bio2BEL generates a download function that wraps Python's built-in urllib module and a simple caching mechanism in the local filesystem that avoids unnecessary network usage and duplication of potentially large files. However, some data sources, such as DrugBank [30], are not available without authentication and cannot make use of this abstraction. In those cases, developers can substitute the standard code provided in the Bio2BEL framework with custom implementations. We have taken this route for several of the packages presented in the Results section of this paper for repositories including DrugBank and MSigDB [31].

Parser

There are several common file formats used by biological data sources (e.g., CSV, TSV, XML, RDF, JSON, KGML, Stockholm, OBO, OWL). Data may also (and sometimes only) be accessible through public application programming interfaces (APIs) such as the data from KEGG [32], Reactome [33], and BioThings [?]. Alternatively, data may be available through software packages usage such the Affymetrix R package [34] and HaploReg (Ward and Kellis, 2012). After each Bio2BEL package's downloader generates a local copy of the data, the developer can either use one of the pre-defined parser functions from the Bio2BEL framework or implement a custom parser. For the most simple formats (i.e., CSV and TSV), the Bio2BEL framework automatically generates a parser that uses the pandas package (McKinney, 2010; <https://github.com/pandas-dev/pandas>). Formats like XML, JSON, and Stockholm have corresponding parsers built into the Python language or standard biology-focused packages, but the information contained within often needs custom logic for restructuring such as in the case of KGML, BioPAX, or PSI MI-XML. The remaining custom formats all require custom parsers and logic. We have already implemented Bio2BEL that used CSV and TSV data (e.g., InterPro, ExCAPE-DB), XML (e.g., DrugBank), RDF (e.g., WikiPathways), JSON and KGML (e.g., KEGG), Stockholm (e.g., miRBase), and OBO and OWL (e.g., GO, DOID).

In the case of tabular data, the developer has the opportunity to annotate the column headers and their corresponding data types, which are not always included in the data and may be sought from various readme files or by exploring the corresponding website. Further, the contained data might be more useful after normalization or augmentation with information from other biological data sources. Because some databases provide identifiers with redundant information, such as the duplication of the namespace in the identifier, they must be normalized. For example, each identifier in the Disease Ontology (Schriml *et al.*, 2018) is prefixed by its namespace, DOID, as can be seen in the Compact URI for the entry for restless legs syndrome, DOID:DOID:0050425. In the corresponding Bio2BEL DOID package, as well as those for others (e.g., HGNC, Gene Ontology) we normalized these identifiers to remove the redundant information. Because the main Entrez Gene database does not contain crucial information for genes, such as their chromosomal coordinates in various genomic builds, we augmented the data in the Bio2BEL Entrez package for each gene with information from RefSeq so that the genomic positions and corresponding genome build for each gene were readily accessible. Additionally, several databases that reference genes only use their HGNC gene symbols and not stable identifiers, and therefore require this additional normalization step.

Storage

Though this step may be considered optional after parsing the data, it is helpful for future reuse to choose a database type and develop a schema with which the data can be stored. Often, relational databases that can be queried with SQL are an appropriate choice. The Bio2BEL framework provides a full harness for generating an object-relational mapping (ORM) using the SQLAlchemy (<https://www.sqlalchemy.org>) Python package that handles generation of the

SQL schema and storage of the data in a SQL database. Corresponding entity-relation diagrams can be found in the supplementary data repository at <https://github.com/bio2bel/bio2bel-manuscript-supplement>. While all Bio2BEL packages have, until now, used SQL databases with the SQLAlchemy ORM, there exists alternatives such as graph databases built on RDF or property graphs like Neo4J or OrientDB with a corresponding object-graph mapper that have been successfully employed in downstream applications using biological knowledge graphs (Himmelstein et al., 2017; Saqi et al., 2018).

Serializer

The final aspect of a Bio2BEL package is either to serialize the parsed data as BEL or to export the accompanying database as BEL. Entities in the SQL database that correspond to nodes and edges in BEL graphs can be converted by extending their respective ORM classes with Python functions using the internal domain-specific language provided by PyBEL (Hoyt et al., 2018a). It can then be output in several formats provided by PyBEL and its growing ecosystem of plugins as well as it shields Bio2BEL packages from changes to the BEL language. Additionally, some Bio2BEL packages wrap standard nomenclature resources such as HGNC (Yates et al., 2017) and are able to generate BEL namespace files that are a necessary in both manual and automated curation of content in BEL (Figure 2). This step is deeply connected with the prior step related to the definition of the data.

Implementation Details

The Bio2BEL framework and Bio2BEL packages are implemented in Python with accessibility and readability in mind. The framework provides an abstract class `bio2bel.Manager` whose functionality all Bio2BEL packages must completely implement. Using these definitions, the framework automatically generates a uniform command line interface (CLI) that includes functions for populating the database, clearing the database, reloading data from the source, generating a web application with a view over the contents of the database, and serializing to BEL.

The Bio2BEL framework and Bio2BEL packages use `flake8` (<https://github.com/PyCQA/flake8>) to enforce code quality, a `setup.cfg` file to describe the package, `setuptools` (<https://github.com/pypa/setuptools>) to build distributions, `pyroma` (<https://github.com/regebro/pyroma>) to enforce package metadata standards, `sphinx` (<https://github.com/sphinx-doc/sphinx>) to build documentation, Read the Docs (<https://readthedocs.org>) to host documentation, `pytest` (<https://github.com/pytest-dev/pytest>) as a testing framework, `coverage` (<https://github.com/nedbat/coveragepy>) and `Codecov` (<https://codecov.io>) to monitor testing coverage, and `Travis-CI` (<https://travis-ci.com>) as a continuous integration service. Further, we provide a template for `Cookiecutter` (<https://github.com/audreyr/cookiecutter>) at <https://github.com/bio2bel/bio2bel-cookiecutter> such that the structure of new packages can be quickly generated containing all of the configuration for each of these tools.

Implications of the Bio2BEL Philosophy

Because all Bio2BEL packages are uniform in their implementation and CLI usage, it is trivial to provide a `Dockerfile` and `Docker-Compose` configuration for quick deployments. In the future, we plan to automatically generate RESTful APIs, which

may be more useful to deploy internally than to use publicly available ones due to constraints like rate-limits. Because all Bio2BEL packages are independent, they avoid two major problems of monolithic codebases: they are more robust to breakages or failures in a single package and they can be installed as needed, which is pertinent as the data sources become larger, more heterogeneous, and more complex.

Further, Bio2BEL packages can be generated by any group, and registered with the Bio2BEL framework using Python entry points (<https://packaging.python.org/specifications/entry-points>) that can be defined in the installation configuration. While the Cookiecutter template allows new developers to quickly generate a package with the correct format, a full tutorial for implementing a uniform Bio2BEL package can be found at <https://bio2bel.readthedocs.io/en/latest/tutorial.html>.

Results

After describing the Bio2BEL framework and the requirements for implementing new Bio2BEL packages, we present a list of the independent Bio2BEL packages that we have already implemented in Table 4. We note that several of the data sources have already been included in other meta-databases like Pathway Commons and Bio2RDF, but we have chosen to implement the Bio2BEL packages using the source data rather than deriving results from these databases to provide a complementary resource for those familiar with and interested in using BEL. This choice also reduces dependencies on other projects that may not be maintained and protects against data loss during multiple conversions.

While there are thousands of high quality databases available, including a high percentage that do not fit into the schemata defined by Pathway Commons, Bio2RDF, or other meta-databases that are more appropriate for BEL, we have prioritized them as they become relevant for our specific use-cases, but also are open to suggestions via the issue tracker on <https://github.com/bio2bel/bio2bel/issues>. Below, we present four of these use cases.

Mapping Concepts Between Pathway Databases with ComPath

Pathway databases have become one of the most frequently used biological data sources in the interpretation of high-throughput *-omics* experiments. Connecting pathway knowledge across the hundreds of databases developed in recent decades would not only provide a more comprehensive overview of the underlying biology they represent, but would also enable performing identical analyses on different databases. However, integrative approaches which combine databases lack the equivalence mappings between similar concepts and qualifiers that are necessary to compare between analyses run using one or another database. There are several reasons that explain the lack of mappings between databases, such as the absence of a common pathway nomenclature, differences in databases' scopes, and the lack of clear pathway boundary definitions. Furthermore, generating high quality mappings requires a significant amount of manual effort since curators must individually investigate each pair of pathways and assess whether the pair comprises related or similar pathways occurring in the same biological context.

Table 4 A non-exhaustive list of biological data sources already available as Bio2BEL packages

Name	Description	Terms	Relations
adeptus	Disease-specific differential gene expression		4943
chebi	Chemical multi-hierarchy	138863	
compath	Pathway-pathway equivalences and hierarchies		1795
ddr	Disease-disease relationships		2997
drugbank	Drug-target interactions	11292	25199
entrez	Genes and orthologies	388986	
excape	Chemical-target interactions		3550000
expasy	Enzyme classification and membership	6718	243914
famlex	Protein family and complex hierarchy		4462
flybase	Drosophila gene nomenclature and orthologies	245565	
go	Biological process multi-hierarchy	45018	92905
hgnc	Human gene nomenclature and orthologies to mouse and rat	42741	38360
hgncgenefamily	Human gene-gene family memberships	1157	23881
hippie	Protein-protein physical interactions		340629
homologene	Gene ortholog group memberships	30492	131558
hsdn	Disease-symptom associations		10246
interpro	Protein-family and protein-domain memberships	36524	34611
kegg	Protein-pathway memberships	330	30346
mgi	Mouse genome nomenclature	300499	
mirbase	MicroRNA nomenclature	38589	
mirtarbase	miRNA-target interactions		366110
msig	Gene-gene set memberships	17810	2443391
pfam	Protein-protein family and protein family-clan memberships	17929	
phewascatalog	Gene-disease relationships		364667
phosphosite	Post-translational modifications		553716
reactome	Protein-pathway and chemical-pathway memberships	23621	137768
rgd	Rat gene nomenclature	44970	
sider	Drugs' side effects and indications		339742
wikipathways	Protein-pathway memberships	513	22115

Three Bio2BEL packages were implemented for major pathway databases (i.e., KEGG, Reactome, and WikiPathways) and extended with tools to support the first curation of mappings between their equivalent and hierarchically related pathways during the ComPath project [35]. Each were used to store and harmonize the data underlying ComPath and its accompanying web curation interface (<https://compath.scai.fraunhofer.de>). Though the databases of the Bio2BEL packages are detached from the ComPath web application, they can be used to integrate additional biological data sources into ComPath in the future and also to regularly update their content over time [36]; thus, facilitating the revisitation and reevaluation of the mappings.

Harmonizing Pathway Databases into a Common Schema with PathMe

The most direct and effective approach in addressing issues of interoperability of pathway databases is in the transformation of various database formats into a common schema. Although this approach has been exemplified by previously mentioned databases (e.g., OmniPath, Pathway Commons, and graphite [37]), there have been several limitations which have impeded a complete harmonization of pathways from distinct biological data sources. Specifically, this requires: the harmonization of biological entities to identifiers from a common nomenclature (e.g., Entrez Gene or HGNC for human genes, ChEBI or PubChem for chemicals, etc.), the normalization of biological relationships, and an underlying format which serves as the unifying schema. However, a complete harmonization risks the loss of some information in the transformation process. For instance, pathway knowledge representations can span across several scales, such as molecular events, cellular processes, and phenotypes, which various formats accommodate for in varying degrees. While existing

biological data sources can address certain aspects of these steps, addressing all of these steps would enable the complete interoperability of pathway databases. Accordingly, the PathMe software was designed to harmonize pathway databases into BEL as a common representation schema with Bio2BEL at its core [38].

The selection of BEL lies in its flexibility to incorporate a wide range of biological entities from standardized nomenclatures and their relationships, all on a multi-modal scale. The transformation of various pathway formats into BEL through PathMe is facilitated by the Bio2BEL framework by allowing for the automation of the acquisition of the biological data sources which can change frequently. By integrating PathMe and Bio2BEL, any number of pathway resources included in the latter can be transformed into BEL. In doing so, users can enrich pathway knowledge by leveraging multiple, equivalent pathway representations from the various biological data sources included in Bio2BEL and analyze their own networks alongside canonical pathway ones. In a later publication, we plan to demonstrate the utility of combining Bio2BEL packages to produce an integrative pathway resource. Similarly to the recent comparison of pathway activity measurement tools by Lim *et al.* (2018), we will benchmark the performance of each of these resources both individually and combined on functional pathway enrichment and classification tasks applied to cancer genome and patient data.

Applications of Network Representation Learning with BioKEEN

The integration of numerous biological databases into a common schema gives rise to large, rich, heterogeneous knowledge graphs to which a variety of statistical and machine learning methodologies can be applied. One family of approaches, network representation learning (NRL), has been shown to be useful for clustering, entity disambiguation, and link prediction tasks (Nickel *et al.*, 2016). As new machine learning models are published for accomplishing these tasks, several implementations using the currently popular machine learning frameworks TensorFlow (Abadi *et al.* 2016) and PyTorch (Paszke *et al.*, 2017) provide reference implementations.

We developed BioKEEN as an extension to the previously developed NRL package, PyKEEN, to enable it to directly acquire and preprocess BEL knowledge graphs, namely those generated by Bio2BEL (Ali *et al.*, 2018). One of the original goals of PyKEEN was to democratize NRL methods by facilitating those less familiar with the relevant mathematics and programming backgrounds to apply and evaluate them. We have continued this philosophy with BioKEEN to allow scientists to specify the Bio2BEL packages they would like to include in their analysis that are either hosted on PyPI, GitHub, or already installed as custom local packages. The usage of Bio2BEL allows scientists using NRL as a component of a more complex analytical pipeline to have the ability to not only re-run analyses in a reproducible manner, but also make use of the ability to acquire updated data when it becomes available.

Along with our previous publication, we provided several demonstrations including the prediction of novel protein-protein interactions using a model trained with the BioKEEN package for the Human Integrated Protein-Protein Interaction rEference (HIPPIE; Alanis-Lobato *et al.*, 2017), the prediction of pathway mappings using ComPath, and the prediction of disease-symptom associations using

the Bio2BEL package for the HSDN (Zhou *et al.*, 2014) provided by Himmelstein *et al.* (2017) with Rephetio (<https://het.io>). Later, we plan to apply BioKEEN to combinations of Bio2BEL repositories to support other biologically relevant link prediction tasks such as drug repositioning.

Interoperability with Other Projects

The Integrated Network and Dynamical Reasoning Assembler (INDRA; Gyori *et al.*, 2017) integrates several databases including those covering physical interactions (e.g., BioGrid; Chatr-Aryamontri *et al.*, 2017), signaling (e.g., SIGNOR; Perfetto *et al.* 2016), curated drug targets (e.g., HMS LINCS small molecule target relationship database; [://lincs.hms.harvard.edu](https://lincs.hms.harvard.edu)), and experimental drug affinities (e.g., Target Affinity Spectrum; Moret *et al.*, 2018) in order to support generation of dynamical models. Following the recent development of a converter between BEL and INDRA (Hoyt *et al.*, 2019), these biological data sources can be indirectly made available as BEL, and all Bio2BEL packages can be integrated in INDRA.

Similarly, we are collaborating with the researchers developing OmniPath to structure their data acquisition pipelines as a Bio2BEL package, which is currently under development. Notably, OmniPath encompasses several biological data sources related to protein-protein interactions, transcriptional regulation, post-translational modifications, ligand-receptor interactions, and protein complexes, and others. This resource is complementary to content already available through Bio2BEL, providing a more comprehensive integration of the extensive publicly available biological data sources.

Conclusions

While the development of Bio2BEL has addressed the lack of defined schemata, data standardization, annotation of entities with classes, and application of controlled vocabularies to relations in numerous biological databases by converting them to BEL, several considerations remain. The approaches taken by Bio2RDF, Pathway Commons, and now Bio2BEL can be categorized as data warehousing. An alternative strategy, data federation, attempts to combine disparate biological data sources using SPARQL endpoints (e.g., DisGeNet-RDF (Queralt-Rosinach *et al.*, 2016), UniProt (Redaschi *et al.*, 2009), EBI (Jupp *et al.*, 2014)), RESTful APIs (e.g., BioServices (Cokelaer *et al.*, 2013), BioThings, Orange Bioinformatics (Curk *et al.*, 2005)), and more recently, GraphQL (<https://graphql.org>). Bio2BEL does not directly address data federation, but other aspects of the BEL ecosystem such as BEL Commons (Hoyt *et al.*, 2018b) have exposed RESTful APIs for manipulating BEL that might also be useful for GraphQL. However, the several attempts at converting BEL to RDF have suffered from relatively low adoption; and while a conversion to RDF enables querying with SPARQL, BEL lacks a dedicated query language that can leverage the rich aspects of its statements beyond their subjects, predicates, and objects.

Finally, it remains that like any format, consumers of BEL must make their own transformations appropriate for their scientific applications. We are not discouraged by this fact, and believe that Bio2BEL is a step towards enabling more computational scientists easy access to a larger portion of the wealth of available structured biological knowledge resources.

Ethics approval and consent to participate

Not applicable

Consent for publication

Not applicable

Availability of data and materials

Each Bio2BEL package is listed on <https://github.com/bio2bel> and automatically acquires relevant data from their respective original biological data sources.

Competing interests

The authors declare that they have no competing interests.

Funding

This work was partially supported by the EU/EFPIA Innovative Medicines Initiative Joint Undertaking under AETIONOMY [grant number 115568], resources of which are composed of financial contribution from the European Union's Seventh Framework Programme (FP7/2007-2013) and EFPIA companies in kind contribution. This work was also partially supported by the Fraunhofer Society's MAVO program. The funding bodies did not play a role in the design of the study and collection, analysis, and interpretation of data, nor in writing the manuscript.

Author's contributions

CTH conceived and designed the study. CTH, DDF, and SM drafted the manuscript. MHA acquired funding and reviewed the manuscript. All authors performed data curation and developed computational pipelines for extraction, transformation, and loading of various biological data sources. All authors have read and approved the final manuscript.

Acknowledgements

We would like to thank the curators and maintainers of the several databases we have used, without whom none of this work would be possible.

Author details

¹ Department of Bioinformatics, Fraunhofer Institute for Algorithms and Scientific Computing (SCAI), Konrad Adenauer Strasse, 53754 Sankt Augustin, Germany. ²Bonn-Aachen International Center for IT, Rheinische Friedrich-Wilhelms-Universität Bonn, 53115 Bonn, Germany. ³ Department of Enterprise Information Systems, Fraunhofer Institute for Intelligent Analysis and Information Systems (IAIS), Konrad Adenauer Strasse, 53754 Sankt Augustin, Germany. ⁴Department of Computer Science, Rheinische Friedrich-Wilhelms-Universität Bonn, 53115 Bonn, Germany. ⁵Department of Chemistry, Stanford University, 94305 Stanford, United States of America. ⁶European Molecular Biology Laboratory (EMBL), Structural and Computational Biology Unit, Meyerhofstrasse 1, 69117 Heidelberg, Germany. ⁷Faculty of Medicine, Joint Research Centre for Computational Biomedicine, RWTH Aachen University, MTZ Pauwelsstrasse 19, 52074 Aachen, Germany. ⁸Faculty of Medicine and Heidelberg University Hospital, Institute of Computational Biomedicine, Heidelberg University, Bioquant Im Neuenheimer Feld 267, 69120 Heidelberg, Germany.

References

- van Dam, J.C.J., Schaap, P.J., Martins dos Santos, V.A.P., Suárez-Diez, M.i.a.: Integration of heterogeneous molecular networks to unravel gene-regulation in *Mycobacterium tuberculosis*. *BMC systems biology* **8**(1), 111 (2014). doi:10.1186/s12918-014-0111-5
- Iyappan, A., Kawalia, S.B., Raschka, T., Hofmann-Apitius, M., Senger, P.: NeuroRDF: semantic integration of highly curated data to prioritize biomarker candidates in Alzheimer's disease. *Journal of Biomedical Semantics* **7**(1), 45 (2016). doi:10.1186/s13326-016-0079-8
- Wanichthanarak, K., Fahrman, J.F., Grapov, D.: Genomic, proteomic, and metabolomic data integration strategies. *Biomarker Insights* **10**(Table 1), 1–6 (2015). doi:10.4137/BMI.S29511
- Himmelstein, D.S., Lizee, A., Hessler, C., Brueggeman, L., Chen, S.L., Hadley, D., Green, A., Khankhanian, P., Baranzini, S.E.: Systematic integration of biomedical knowledge prioritizes drugs for repurposing. *eLife* **6** (2017). doi:10.7554/eLife.26726
- Fan, X.-N., Zhang, S.-W., Zhang, S.-Y., Zhu, K., Lu, S.: Prediction of lncRNA-disease associations by integrating diverse heterogeneous information sources with RWR algorithm and positive pointwise mutual information. *BMC Bioinformatics* **20**(1), 87 (2019). doi:10.1186/s12859-019-2675-y
- Davidson, S.B., Overton, C., Buneman, P.: Challenges in integrating biological data sources. *Journal of computational biology: a journal of computational molecular cell biology* **2**(4), 557–572 (1995). doi:10.1089/cmb.1995.2.557
- Belleau, F.c.o., Nolin, M.-A., Tourigny, N., Rigault, P., Morissette, J.: Bio2RDF: Towards a mashup to build bioinformatics knowledge systems. *Journal of Biomedical Informatics* **41**(5), 706–716 (2008). doi:10.1016/j.jbi.2008.03.004
- Chen, B., Dong, X., Jiao, D., Wang, H., Zhu, Q., Ding, Y., Wild, D.: Chem2Bio2RDF: a semantic framework for linking and data mining chemogenomic and systems chemical biology data. *BMC Bioinformatics* **11**, 255 (2010)
- Williams, A.J., Harland, L., Groth, P., Pettifer, S., Chichester, C., Willighagen, E.L., Evelo, C.T., Blomberg, N., Ecker, G., Goble, C., Mons, B.: Open PHACTS: semantic interoperability for drug discovery. *Drug Discovery Today* **17**(21–22), 1188–1198 (2012). doi:10.1016/j.drudis.2012.05.016
- Alocci, D., Mariethoz, J., Horlacher, O., Bolleman, J.T., Campbell, M.P., Lisacek, F.: Property Graph vs RDF triple store: A comparison on glycan substructure search. *PLoS ONE* **10**(12), 1–17 (2015). doi:10.1371/journal.pone.0144578

11. Warde-Farley, D., Donaldson, S.L., Comes, O., Zuberi, K., Badrawi, R., Chao, P., Franz, M., Grouios, C., Kazi, F., Lopes, C.T., Maitland, A., Mostafavi, S., Montojo, J., Shao, Q., Wright, G., Bader, G.D., Morris, Q.: The GeneMANIA prediction server: Biological network integration for gene prioritization and predicting gene function. *Nucleic Acids Research* **38**(SUPPL. 2), 214–220 (2010). doi:10.1093/nar/gkq537
12. Szklarczyk, D., Franceschini, A., Wyder, S., Forslund, K., Heller, D., Huerta-Cepas, J., Simonovic, M., Roth, A., Santos, A., Tsafou, K.P., Kuhn, M., Bork, P., Jensen, L.J., Von Mering, C.: STRING v10: Protein-protein interaction networks, integrated over the tree of life. *Nucleic Acids Research* **43**(D1), 447–452 (2015). doi:10.1093/nar/gku1003
13. Stelzer, G., Rosen, N., Plaschkes, I., Zimmerman, S., Twik, M., Fishilevich, S., Iny Stein, T., Nudel, R., Lieder, I., Mazor, Y., Kaplan, S., Dahary, D., Warshawsky, D., Guan-Golan, Y., Kohn, A., Rappaport, N., Safran, M., Lancet, D.: The GeneCards suite: From gene data mining to disease genome sequence analyses. *Current Protocols in Bioinformatics* **2016**(June), 1–30113033 (2016). doi:10.1002/cpbi.5
14. Laibe, C., Le Novère, N.: MIRIAM Resources: tools to generate and resolve robust cross-references in Systems Biology. *BMC systems biology* **1**, 58 (2007). doi:10.1186/1752-0509-1-58
15. Courtot, M.e.l., Juty, N., Knüpfner, C., Waltemath, D., Zhukova, A., Dräger, A., Dumontier, M., Finney, A., Golebiewski, M., Hastings, J., Hoops, S., Keating, S., Kell, D.B., Kerrien, S., Lawson, J., Lister, A., Lu, J., MacHne, R., Mendes, P., Pocock, M., Rodriguez, N., Villeger, A., Wilkinson, D.J., Wimalaratne, S., Laibe, C., Hucka, M., Le Novère, N.: Controlled vocabularies and semantics in systems biology. *Molecular Systems Biology* **7**(543) (2011). doi:10.1038/msb.2011.77
16. Treier, D.e.n., Korcsmáros, T.a.s., Saez-Rodríguez, J.: OmniPath: guidelines and gateway for literature-curated signaling pathway resources. *Nature Methods* **13**(12), 966–967 (2016). doi:10.1038/nmeth.4077
17. Cerami, E.G., Gross, B.E., Demir, E., Rodchenkov, I., Babur, O.z.u.n., Anwar, N., Schultz, N., Bader, G.D., Sander, C.: Pathway Commons, a web resource for biological pathway data. *Nucleic Acids Research* **39**(SUPPL. 1), 685–690 (2011). doi:10.1093/nar/gkq1039
18. Demir, E., Cary, M.P., Paley, S., Fukuda, K., Lemer, C., Vastrik, I., Wu, G., D'Eustachio, P., Schaefer, C., Luciano, J., Schacherer, F., Martinez-Flores, I., Hu, Z., Jimenez-Jacinto, V., Joshi-Tope, G., Kandasamy, K., Lopez-Fuentes, A.C., Mi, H., Pichler, E., Rodchenkov, I., Splendiani, A., Tkachev, S., Zucker, J., Gopinath, G., Rajasimha, H., Ramakrishnan, R., Shah, I., Syed, M., Anwar, N., Babur, O.z.u.n., Blinov, M., Brauner, E., Corwin, D., Donaldson, S., Gibbons, F., Goldberg, R., Hornbeck, P., Luna, A., Murray-Rust, P., Neumann, E., Reubenacker, O., Samwald, M., van Iersel, M., Wimalaratne, S., Allen, K., Braun, B., Whirl-Carrillo, M., Cheung, K.-H., Dahlquist, K., Finney, A., Gillespie, M., Glass, E., Gong, L., Haw, R., Honig, M., Hubaut, O., Kane, D., Krupa, S., Kutmon, M., Leonard, J., Marks, D., Merberg, D., Petri, V., Pico, A., Ravenscroft, D., Ren, L., Shah, N., Sunshine, M., Tang, R., Whaley, R., Letovsky, S., Buetow, K.H., Rzhetsky, A., Schachter, V., Sobral, B.S., Dogrusoz, U., McWeeney, S., Aladjem, M., Birney, E., Collado-Vides, J., Goto, S., Hucka, M., Novère, N.L., Maltsev, N., Pandey, A., Thomas, P., Wingender, E., Karp, P.D., Sander, C., Bader, G.D.: The BioPAX community standard for pathway data sharing. *Nature Biotechnology* **28**(12), 1308–1308 (2010). doi:10.1038/nbt1210-1308c
19. Slater, T.: Recent advances in modeling languages for pathway maps and computable biological networks. *Drug Discovery Today* **19**(2), 193–198 (2014). doi:10.1016/j.drudis.2013.12.011
20. Naz, M., Kodamullil, A.T., Hofmann-Apitius, M.: Reasoning over genetic variance information in cause-and-effect models of neurodegenerative diseases. *Briefings in bioinformatics* **17**(3), 505–16 (2016). doi:10.1093/bib/bbv063
21. Khanam Irin, A., Tom Kodamullil, A., Gündel, M., Hofmann-Apitius, M.: Computational Modelling Approaches on Epigenetic Factors in Neurodegenerative and Autoimmune Diseases and Their Mechanistic Analysis. *Journal of Immunology Research* **2015**, 1–10 (2015). doi:10.1155/2015/737168
22. Emon, M.A.E.K., Kodamullil, A.T., Karki, R., Younesi, E., Hofmann-Apitius, M.: Using Drugs as Molecular Probes: A Computational Chemical Biology Approach in Neurodegenerative Diseases. *Journal of Alzheimer's Disease* **56**(2), 677–686 (2017). doi:10.3233/JAD-160222
23. Iyappan, A., Younesi, E., Redolfi, A., Vrooman, H., Khanna, S., Frisoni, G.B., Hofmann-Apitius, M.: Neuroimaging Feature Terminology: A Controlled Terminology for the Annotation of Brain Imaging Features. *Journal of Alzheimer's Disease* **59**(4), 1153–1169 (2017). doi:10.3233/jad-161148
24. Cote, R., Jones, P., Apweiler, R., Hermjakob, H.: The Ontology Lookup Service, a lightweight cross-platform tool for controlled vocabulary queries. *BMC Bioinformatics* **7**, 1–7 (2006). doi:10.1186/1471-2105-7-97
25. Rogers, F.B.: Medical subject headings. *Bulletin of the Medical Library Association* **51**, 114–6 (1963)
26. Meldal, B.H.M., Forner-Martinez, O., Costanzo, M.C., Dana, J., Demeter, J., Dumousseau, M., Dwight, S.S., Gaulton, A., Licata, L., Melidoni, A.N., Ricard-Blum, S., Roechert, B., Skyzypek, M.S., Tiwari, M., Velankar, S., Wong, E.D., Hermjakob, H., Orchard, S.: The complex portal - An encyclopaedia of macromolecular complexes. *Nucleic Acids Research* **43**(D1), 479–484 (2015). doi:10.1093/nar/gku975
27. Carbon, S., Dietze, H., Lewis, S.E., Mungall, C.J., Munoz-Torres, M.C., Basu, S., Chisholm, R.L., Dodson, R.J., Fey, P., Thomas, P.D., Mi, H., Muruganujan, A., Huang, X., Poudel, S., Hu, J.C., Aleksander, S.A., McIntosh, B.K., Renfro, D.P., Siegel, D.A., Antonazzo, G., Attrill, H., Brown, N.H., Marygold, S.J., McQuilton, P., Ponting, L., Millburn, G.H., Rey, A.J., Stefancsik, R., Tweedie, S., Falls, K., Schroeder, A.J., Courtot, M., Osumi-Sutherland, D., Parkinson, H., Roncaglia, P., Lovering, R.C., Foulger, R.E., Huntley, R.P., Denny, P., Campbell, N.H., Kramarz, B., Patel, S., Buxton, J.L., Umrao, Z., Deng, A.T., Alrohaif, H., Mitchell, K., Ratnaraj, F., Omer, W., Rodríguez-López, M., C. Chibucos, M., Giglio, M., Nadendla, S., Duesbury, M.J., Koch, M., Meldal, B.H.M., Melidoni, A., Porras, P., Orchard, S., Shrivastava, A., Chang, H.Y., Finn, R.D., Fraser, M., Mitchell, A.L., Nuka, G., Potter, S., Rawlings, N.D., Richardson, L., Sangrador-Vegas, A., Young, S.Y., Blake, J.A., Christie, K.R., Dolan, M.E., Drabkin, H.J., Hill, D.P., Ni, L., Sitnikov, D., Harris, M.A., Hayles, J., Oliver, S.G., Rutherford, K., Wood, V., Bahler, J., Lock, A., De Pons, J., Dwinell, M., Shimoyama, M., Laulederkind, S., Hayman, G.T., Tutaj, M., Wang, S.J., D'Eustachio, P., Matthews, L., Balhoff, J.P., Balakrishnan, R., Binkley, G., Cherry, J.M., Costanzo, M.C., Engel, S.R., Miyasato, S.R., Nash,

- R.S., Simison, M., Skrzypek, M.S., Weng, S., Wong, E.D., Feuermann, M., Gaudet, P., Berardini, T.Z., Li, D., Muller, B., Reiser, L., Huala, E., Argasinska, J., Arighi, C., Auchincloss, A., Axelsen, K., Argoud-Puy, G., Bateman, A., Bely, B., Blatter, M.C., Bonilla, C., Bougueleret, L., Boutet, E., Breuza, L., Bridge, A., Britto, R., Hye- A-Bye, H., Casals, C., Cibrian-Uhalte, E., Coudert, E., Cusin, I., Duek-Roggli, P., Estreicher, A., Famiglietti, L., Gane, P., Garmiri, P., Georgioui, G., Gos, A., Gruaz-Gumowski, N., Hatton-Ellis, E., Hinz, U., Holmes, A., Hulo, C., Jungo, F., Keller, G., Laiho, K., Lemercier, P., Lieberherr, D., Mac- Dougall, A., Magrane, M., Martin, M.J., Masson, P., Natale, D.A., O'Donovan, C., Pedruzzi, I., Pichler, K., Poggioli, D., Poux, S., Rivoire, C., Roechert, B., Sawford, T., Schneider, M., Speretta, E., Shypitsyna, A., Stutz, A., Sundaram, S., Tognolli, M., Wu, C., Xenarios, I., Yeh, L.S., Chan, J., Gao, S., Howe, K., Kishore, R., Lee, R., Li, Y., Lomax, J., Muller, H.M., Raciti, D., Van Auken, K., Berriman, M., Stein, Paul Kersey, L., W. Sternberg, P., Howe, D., Westerfield, M.: Expansion of the gene ontology knowledgebase and resources: The gene ontology consortium . *Nucleic Acids Research* **45**(D1), 331–338 (2017). doi:10.1093/nar/gkw1108
28. Sun, K., Pr ž ulj, N.v.a., Buchan, N., Larminie, C.: The integrated disease network . *Integrative Biology* **6**(11), 1069–1079 (2014). doi:10.1039/c4ib00122b
 29. Menche, J.o.r., Sharma, A., Kitsak, M., Ghiassian, S.D., Vidal, M., Loscalzo, J., Barab á si, A.-L.a.s.o.: Disease networks. Uncovering disease-disease relationships through the incomplete interactome. . *Science (New York, N.Y.)* **347**(6224), 1257601 (2015). doi:10.1126/science.1257601. 15334406
 30. Wishart, D.S., Feunang, Y.D., Guo, A.C., Lo, E.J., Marcu, A., Grant, J.R., Sajed, T., Johnson, D., Li, C., Sayeeda, Z., Assempour, N., Lynkkaran, I., Liu, Y., Maciejewski, A., Gale, N., Wilson, A., Chin, L., Cummings, R., Le, D., Pon, A., Knox, C., Wilson, M.: DrugBank 5.0: a major update to the DrugBank database for 2018. . *Nucleic acids research* **46**(D1), 1074–1082 (2018). doi:10.1093/nar/gkx1037
 31. Liberzon, A., Birger, C., Thorvaldsd ó ttir, H., Ghandi, M., Mesirov, J., Tamayo, P.: The Molecular Signatures Database Hallmark Gene Set Collection . *Cell Systems* **1**(6), 417–425 (2015). doi:10.1016/J.CELS.2015.12.004
 32. Kanehisa, M., Furumichi, M., Tanabe, M., Sato, Y., Morishima, K.: KEGG: New perspectives on genomes, pathways, diseases and drugs . *Nucleic Acids Research* **45**(D1), 353–361 (2017). doi:10.1093/nar/gkw1092. 1611.06654
 33. Fabregat, A., Jupe, S., Matthews, L., Sidiropoulos, K., Gillespie, M., Garapati, P., Haw, R., Jassal, B., Korninger, F., May, B., Milacic, M., Roca, C.D., Rothfels, K., Sevilla, C., Shamovsky, V., Shorser, S., Varusai, T., Viteri, G., Weiser, J., Wu, G., Stein, L., Hermjakob, H., D'Eustachio, P.: The Reactome Pathway Knowledgebase . *Nucleic Acids Research* **46**(D1), 649–655 (2018). doi:10.1093/nar/gkx1132. NIHMS150003
 34. Gautier, L., Cope, L., Bolstad, B.M., Irizarry, R.A.: Affy - Analysis of Affymetrix GeneChip data at the probe level . *Bioinformatics* **20**(3), 307–315 (2004). doi:10.1093/bioinformatics/btg405
 35. Domingo-Fernandez, D., Hoyt, C.T., Alvarez, C.B., Marin-Llao, J., Hofmann-Apitius, M., Domingo-Fern á ndez, D., Hoyt, C.T., Bobis- Á lvarez, C., Mar í n-Lla ó , J., Hofmann-Apitius, M.: ComPath: an ecosystem for exploring, analyzing, and curating mappings across pathway databases . *npj Systems Biology and Applications* **5**(1), 3 (2018). doi:10.1038/s41540-018-0078-8
 36. Wadi, L., Meyer, M., Weiser, J., Stein, L.D., Reimand, J.u.r.: Impact of outdated gene annotations on pathway enrichment analysis . *Nature Methods* **13**(9), 705–706 (2016). doi:10.1038/nmeth.3963
 37. Sales, G., Calura, E., Romualdi, C.: Meta Graphite-a new layer of pathway annotation to get metabolite networks . *Bioinformatics* **35**(7), 1258–1260 (2019). doi:10.1093/bioinformatics/bty719
 38. Domingo-Fern á ndez, D., Mubeen, S., Mar í n-Lla ó , J., Hoyt, C.T., Hofmann-Apitius, M.: PathMe: merging and exploring mechanistic pathway knowledge . *BMC Bioinformatics* **20**(1), 243 (2019). doi:10.1186/s12859-019-2863-9

Postface

Several applications of Bio2BEL were presented. First, Bio2BEL enabled the mapping of pathways between databases like KEGG [59], Reactome [60], and WikiPathways [141] for the ComPath database [137]. This project leveraged each of these pathway databases as well as nomenclature resources like HGNC, Entrez, UniProt, and ChEBI to normalize entities into cohesive biomedical knowledge graphs on top of which algorithms for identifying overlapping pathways were used to prioritize curation.

Second, the Bio2BEL framework was used to organize the harmonization of pathway databases into a common schema using PathMe [77]. This project showcased the Bio2BEL philosophy of reproducibility and reusability because the formats used by each of the pathway databases varied and create significant overhead for new users.

Third, Bio2BEL packages have been used in the application of NRL methods using BioKEEN [107]. Because this project saw the generation of a converter for any BEL into a format that can be embedded using NRL, any new Bio2BEL package can be readily used.

Finally, the Bio2BEL project lead to the integration with several other data aggregation systems. Integration with INDRA [111] was done through the development of the PyBEL processor¹ and subsequent inclusion within the Bio2BEL framework². Integration with OmniPath [142] was done during the course of the work that comprised the previous publication in the v0.8 release of *PyPath*³. Further systems will be integrated in the future, such as the sources composing Pathway Commons [62].

Given the PyBEL ecosystem first introduced in Chapter 2, the environment for exploration presented in Chapter 3, the enrichment workflow presented in Chapter 4, and Bio2BEL, it is possible to generate and handle high quality biological knowledge graphs to support downstream analysis. The remaining Chapters 6, 7, and 8 constitute three examples of these downstream analyses.

¹<https://indra.readthedocs.io/en/latest/modules/sources/bel/index.html#module-indra.sources.bel.processor>

²<https://github.com/bio2bel/bio2bel/commit/e52eefad11f38f6654b2c27724ea9f3600f58405>

³<https://github.com/saezlab/pypath>

6 BEL2ABM: agent-based simulation of static models in Biological Expression Language

Preface

While previous chapters have improved the ability of BEL to model multi-modal and multi-scale aspects of complex disease while integrating content from both unstructured text and structured sources, it has been limited by its inability to express the temporal dimension of the underlying biology. Even further, the time scales corresponding to molecular and clinically measurable processes and biomarkers differ by several orders of magnitude. Following the description of biomarkers' relations to disease-specific pathways encoded in NeuroMMSig [131], this publication describes an attempt at simulating their clinical trajectories. While others have focused on modeling timescales on the clinical level, the following publication presents a workflow (BEL2ABM) for converting knowledge graphs in BEL into dynamic, executable, agent-based models.

Reprinted with permission from "Gündel, M., Hoyt, C.T., & Hofmann-Apitius, M. (2018). BEL2ABM: Agent-based simulation of static models in Biological Expression Language. *Bioinformatics*, 34(13), 2316–2318.". Copyright © Gündel, M., *et al.*, 2018.

Systems biology

BEL2ABM: agent-based simulation of static models in Biological Expression Language

Michaela Gündel^{1,2,*}, Charles Tapley Hoyt^{1,2} and Martin Hofmann-Apitius^{1,2}

¹Department of Bioinformatics, Fraunhofer Institute for Algorithms and Scientific Computing (SCAI), Sankt Augustin 53754, Germany and ²Department of Life Science Informatics, Bonn-Aachen International Center for IT, Rheinische Friedrich-Wilhelms-Universität Bonn, Bonn 53113, Germany

*To whom correspondence should be addressed.

Associate Editor: Bonnie Berger

Received on July 25, 2017; revised on December 9, 2017; editorial decision on February 20, 2018; accepted on February 21, 2018

Abstract

Summary: While cause-and-effect knowledge assembly models encoded in Biological Expression Language are able to support generation of mechanistic hypotheses, they are static and limited in their ability to encode temporality. Here, we present BEL2ABM, a software for producing continuous, dynamic, executable agent-based models from BEL templates.

Availability and implementation: The tool has been developed in Java and NetLogo. Code, data and documentation are available under the Apache 2.0 License at <https://github.com/pybel/bel2abm>.

Contact: martin.hofmann-apitius@scai.fraunhofer.de

Supplementary information: [Supplementary data](#) are available at *Bioinformatics* online.

1 Introduction

The ability of Biological Expression Language (BEL) to encode qualitative cause-and-effect relationships from biological systems makes it well-suited for generating mechanistic hypotheses in the context of experimental data (Catlett *et al.*, 2013). However, it generally lacks the ability to describe the temporal evolution of dynamic systems except in special cases where time can be represented discretely. For example, the progression of Alzheimer's disease (AD) is often discretized to healthy, mild cognitive impairment and full AD. While other systems biology modeling languages such as Systems Biology Markup Language can natively embed mathematical equations in order to support simulations and produce generative models (Hucka *et al.*, 2003), they lack the ability of BEL to represent multi-scale and multi-modal processes.

To the best of our knowledge, there have not been any previously published attempts to produce dynamic biological models from BEL. A simple approach to introduce dynamism would be to convert to rule-based models such as Petri nets. However, discrete dynamism is inherently limited in its expressivity. Continuous dynamism can be achieved through agent-based modeling (ABM); where a discrete

number of entities, their properties and their methods of interaction are encoded and simulated in a complex system. In addition, ABMs do not require fine-granular knowledge of the reaction rates and other kinetic properties of a system that often limit the utility of mathematical models.

Here, we present BEL2ABM, a software package that transforms static BEL knowledge assemblies into continuous, dynamic, executable, ABMs.

2 Materials and methods

All physical entities in a BEL knowledge assembly are encoded as agents with properties (e.g. lifespans, ability to reproduce, etc.) described by the Human Physiology Simulation Ontology (HuPSON) (Gündel *et al.*, 2013) and behaviors derived from their relationships to other entities in the BEL knowledge assembly. Statements like *A increases B* creates a behavior where a unilateral coupling between *A* and *B* stochastically increases the number or scale of *B*. For example, the statement *p(A) increases kinaseActivity(p(B))* represents that when the two proteins *A* and *B* are within interaction distance, the kinase activity property

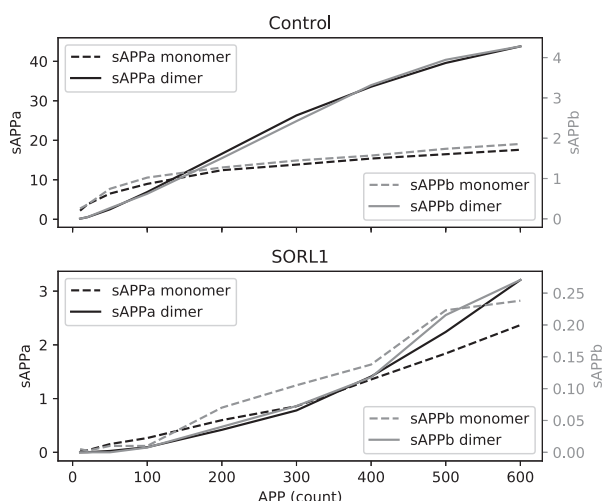

Fig. 1. Plotted are average initial rates of the production of sAPPa, sAPPb and their respective homodimers in the BEL2ABM simulation based on the amyloid beta cascade with varying initial number of APP agents. The sigmoidal curves observed in the control correspond to the cooperativity of the allosteric secretase dimers of sAPPa and sAPPb. Perturbation with SORL1 inhibits oligomerization, shown by the loss of sigmoidal shape, as well as causing significant decrease in the production of each of sAPPa, sAPPb and their respective homodimers. Settings alpha secretases: 10; alpha secretase dimers: 10; beta secretases: 1; beta secretase dimers: 1; SORL1: 3; APP binding sites of allosteric enzymes: 2; binding strengths: 95%; high lifespans so few molecule dies during experiment; 400 replicate runs at each APP concentration

of B is increased. Biological processes are translated to procedures which have effects determined by HuPSON over a large physical area within the ABM simulation. Finally, additional information is encoded about each entity type that is available from context-specific annotations in BEL (e.g. cellular locations) and HuPSON. A complete schema for converting BEL to ABM properties and behaviors can be found in the [Supplementary Material](#).

Temporality is introduced with NetLogo (<https://ccl.northwest.ern.edu/netlogo>) which updates agents based on simulation parameters and their internal properties at small discrete time points to simulate continuous time. It provides an environment where users can adjust modeling parameters (i.e. molecule numbers, interaction distances, movement speed, etc.) and produce replicates.

Finally, Spartan (Alden *et al.*, 2014) is used to perform consistency analysis, evaluate the results and establish the minimal number of replicates needed. For many applications of ABMs, the number of each type of entity at each time point is of great interest. Using the replicates from Spartan, the numbers at each time point are averaged in order to provide more robust results.

3 Case study

The processing of amyloid beta precursor-protein (APP) in the amyloid cascade has been highly implicated in AD. Recent experimental evidence has shown not only that the α -secretase and β -secretase enzymes act cooperatively as allosteric homodimers in the cleavage of APP, but this process is also inhibited by sortilin related receptor 1 (SORL1) through the blocking APP oligomerization (Schmidt *et al.*, 2012).

As a case study, we encoded the relevant entities, processes and relations from the amyloid beta cascade in BEL in order to assess the ability of BEL2ABM to produce an ABM that replicates the sigmoidal patterns of enzyme cooperativity observed in experimental

observations and captured in ordinary differential equations (ODE) shown in Figure 11 of Schmidt *et al.*

While the resulting ABM provides a wealth of information about each of the entities involved in the system, Figure 1 presents the most relevant measurements representing the respective initial rates of production of sAPPa and sAPPb as a function of the initial amount of APP present that can be compared to Figure 11 of Schmidt *et al.* Both the sAPPa and sAPPb curves adhere to the sigmoidal patterns observed in vitro and described by the ODE from Schmidt *et al.* Additionally, the presence of SORL1 in the ABM also reproduced the behavior of significantly decreasing the production rates of sAPPa and sAPPb, solely based on the knowledge encoded in BEL of the agents, their properties and their behaviors.

After investigating the model's robustness to parameter settings using Spartan, we concluded that this model was sufficiently robust to both simulation stochastic noise (with a minimum of 400 replicates) and to parameter value change. The case of the initial α -secretase number (at $t=0$) showed medium to medium-high effect over a large range (10–600) of initial APP entities; whereas changes in α -secretase binding strength showed only a small effect for low, and medium effect for high APP numbers. The underlying BEL document, BEL resources, NetLogo settings and results can all be found at <https://github.com/pybel/bel2abm>.

4 Discussion

Because BEL2ABM produces inherently qualitative models, several constraints must be considered during their evaluation. The magnitude of the results cannot be directly compared to experimental results or mathematical models such as the ODE system provided by Schmidt *et al.* because time and space are only artificially incorporated during simulation. Thus, we only expect to observe similar behavioral patterns of a real biological system.

NetLogo and other common simulation environments allow users to modify various simulation parameters in order to improve the adherence of an ABM to experimental data. While this allows users to the benefit of exploring based on their intuition, systematic optimization becomes a combinatorial problem for larger and more complex systems. BEL2ABM includes some semi-automatic parameter optimization methods and can be theoretically run with an optimization procedure like a grid search, but future work will include developing and encoding more biologically-driven optimization procedures in an ontology, like HuPSON, that can be leveraged to more automatically build relevant models. Further, the burden of choosing the most relevant and informative knowledge assemblies for BEL2ABM may be eased by the hypothesis generation procedures in upcoming BEL frameworks like PyBEL (Hoyt *et al.*, 2018).

With these restrictions in mind, we have shown that it is possible to dynamize a static knowledge assembly model, enable a user to qualitatively reproduce the behavior a biological system, and modify model parameters in order to make further investigations.

Acknowledgements

This work has been supported by the B-IT Foundation.

Conflict of Interest: none declared.

References

Alden, K.J. *et al.* (2014) Applying spartan to understand parameter uncertainty in simulations. *R. J.*, 6, 63–80.

- Catlett, N.L. *et al.* (2013) Reverse causal reasoning: applying qualitative causal knowledge to the interpretation of high-throughput data. *BMC Bioinformatics*, **14**, 340.
- Gündel, M. *et al.* (2013) HuPSON: the human physiology simulation ontology. *J. Biomed. Seman.*, **4**, 35.
- Hoyt, C.T. *et al.* (2018) PyBEL: a computational framework for Biological Expression Language. *Bioinformatics*, **34**, 703–704.
- Hucka, M. *et al.* (2003) The systems biology markup language (SBML): a medium for representation and exchange of biochemical network models. *Bioinformatics (Oxford, England)*, **19**, 524–531.
- Schmidt, V. *et al.* (2012) Quantitative modelling of amyloidogenic processing and its influence by SORLA in Alzheimer's disease. *EMBO J.*, **31**, 187–200.

Postface

A proof of concept was presented that successfully reproduced the results of a past analysis based on an ordinary differential equation model describing the amyloid cascade from Schmidt *et al.* [143] using a BEL model of the amyloid cascade as an input to BEL2ABM. However, as this publication presented novel methodology for converting knowledge graphs into executable models, further examples of better understood and more data-rich biology (e.g., oncology) would be necessary to justify further investigation. Additionally, at the time of publication, the ecosystem for sustainable and reproducible research in agent-based modeling was very weak. Significant improvements to this ecosystem are also a necessary prerequisite for continued investigation.

While differential equation modeling has historically suffered from issues in scalability, agent-based modeling approaches are much more amenable to parallelization. However, agent-based modeling faces the same issues in optimizing hyperparameters as differential equation modeling [144] and recent drastic improvements in differential equation solvers [145–147] has lowered the burden of large differential equation systems, which may make them a more compelling option.

While BEL2ABM currently only supports a small subset of the events that can be expressed in BEL, it represents a first step towards the ability to automatically generate dynamic models from static knowledge. Further steps will be taken during an upcoming master's thesis at the Fraunhofer SCAI Department of Bioinformatics. Combined with the ability to automatically generate and maintain knowledge graphs containing the highest quality content from structured sources as presented in Chapter 5 and new relevant content from unstructured sources as presented in Chapter 4, this framework is one option to overcome previously described challenges faced by both more simple and more powerful modeling techniques.

7 GuiltyTargets: prioritization of novel therapeutic targets with deep network representation learning

Preface

The choice of a target protein whose modulation may cause a therapeutic effect in a target disease is essential for success in drug discovery. Unfortunately, the majority of clinical trials fail due to low efficacy, often attributed to a poor choice of target protein. Computational target prioritization approaches aim to support target selection by ranking candidate targets in the context of a given disease. The following publication presents a novel target prioritization approach, GuiltyTargets, which relies on NRL of protein-protein interaction networks annotated with disease-specific differential gene expression. These techniques are not only useful in investigation of new diseases, but also in the attribution of previously studied drugs to new indications when their targets can be shown to be relevant in new therapeutic indications.

Reprinted with permission from "Muslu, Ö., Hoyt, C. T., Hofmann-Apitius, M., & Fröhlich, H. (2019) GuiltyTargets: Prioritization of Novel Therapeutic Targets with Deep Network Representation Learning. *IEEE/ACM Trans. Comput. Biol. Bioinform., submitted*". Copyright © Muslu, Ö., et al., 2019.

GuiltyTargets: Prioritization of Novel Therapeutic Targets with Deep Network Representation Learning

Özlem Muslu^{1,2}, Charles Tapley Hoyt^{1,2}, Martin Hofmann-Apitius^{1,2}, Holger Fröhlich^{2,3,*}

1 Department of Bioinformatics, Fraunhofer Institute for Algorithms and Scientific Computing (SCAI), Schloss Birlinghoven, Sankt Augustin, 53754, Germany

2 Bonn-Aachen International Center for Information Technology (B-IT), University of Bonn, 53115, Bonn, Germany

3 UCB Biosciences GmbH, Alfred-Nobel Str. 10, 40789 Monheim, Germany

*Corresponding author: frohlich@bit.uni-bonn.de

Abstract

The majority of clinical trial failures are caused by low efficacy of investigated drugs, often due to a poor choice of target protein. Computational prioritization approaches aim to support target selection by ranking candidate targets in the context of a given disease. We propose a novel target prioritization approach, GuiltyTargets, which relies on deep network representation learning of a genome-wide protein-protein interaction network annotated with disease-specific differential gene expression and uses positive-unlabeled machine learning for candidate ranking. We evaluated our approach on six diseases of different types (cancer, metabolic, neurodegenerative) within a 10 times repeated 5-fold stratified cross-validation and achieved AUROC values between 0.92 - 0.94, significantly outperforming a previous approach, which relies on manually engineered topological features. Moreover, we showed that GuiltyTargets allows for target repositioning across related disease areas. Applying GuiltyTargets to Alzheimer's disease resulted into a number of highly ranked candidates that are currently discussed as targets in the literature. Interestingly, one (COMT) is also the target of an approved drug (Tolcapone) for Parkinson's disease, highlighting the potential for target repositioning of our method.

Availability: The GuiltyTargets Python package is available on PyPI and all code used for analysis can be found under the MIT License at <https://github.com/GuiltyTargets>.

Author summary

Many drug candidates fail in clinical trials due to low efficacy. One of the reasons is the choice of the wrong target protein, i.e. perturbation of the protein does not effectively modulate the disease phenotype on a molecular level. In consequence many patients do not demonstrate a clear response to the drug candidate. Traditionally, targets are selected based on evidence from the literature and follow-up experiments. However, this process is very labor intensive and often biased by subjective choices. Computational tools could help a more rational and unbiased choice of target proteins and thus increase the chance of drug discovery programs. In this work we propose a novel machine learning based method for target candidate ranking. The method (GuiltyTargets) captures properties of known targets to learn a ranking of candidates. GuiltyTargets compares favorably against existing machine learning based target prioritization methods and allowed us to propose novel targets for Alzheimer's disease.

Introduction

Drug discovery is a time consuming, expensive and complicated process [1–4]. Many drug candidates fail in clinical studies due to low efficacy, mainly because of wrong target choice [5–7]. Traditionally, scientists identified targets by searching through the relevant literature, following clues from mRNA and protein expression, integrating expression data with pathway analyses, experimenting with knockout mice, investigating somatic mutations, gene fusions, and copy number variations, and using the accumulated knowledge from multiple experimental studies to generate a hypothesis on how a molecule might work as a target [2, 8, 9]. However, manually interpreting many data sources is prone to biased identification of targets as it limits the potential to use all available and helpful data. By computationally integrating multiple biological data sources to analyze prior knowledge, it should be possible to make target identification process faster, less biased, and more informed. Computational target prioritization approaches thus aim for improving target identification process by ranking proteins based on their likelihood of being targets in the context of a specific disease [10–17]. Most of them integrate biological networks with other data sources to prioritize targets for infectious diseases [11–13], cancers [14–16] or neurodegenerative diseases [17].

In addition, machine learning methods have been used to prioritize drug targets. For example, Emig *et al.* proposed an approach, in which for each candidate target a number of different network topological features are combined with proximity to differentially expressed genes in a particular disease of interest [10]. All features are subsequently combined into a logistic regression model, which allows for a ranking of candidate targets. The authors successfully tested their approach with 30 different diseases. Another example is the method by Ferrero *et al.*, which uses features provided by the Open Targets database [18] and combines them into one ranking score using Support Vector Machines [19].

In this paper we propose a novel approach to prioritize targets using a combination of unsupervised network representation learning, namely the recently proposed Gat2Vec method [20], and logistic regression. More specifically, our method, GuiltyTargets, first maps a genome-wide protein-protein interaction network annotated with differential gene expression information into an Euclidean space using Gat2Vec. In that space, we then use positive-unlabeled (PU) machine learning [21–24] to learn a ranking of candidate targets. To the best of our knowledge, network representation learning as a data driven approach to implicitly learn relevant topological features from a network structure has not been used for target prioritization so far. The proposed approach is compared to the approach from Emig *et al.* [10] for six diseases, demonstrating its superior ranking performance. For the example of Alzheimer’s disease (AD), in-depth analysis shows that GuiltyTargets can be used to reposition known targets from other neurological indications.

Results

GuiltyTargets: A New Approach for Deep Network Representation Learning Based Target Prioritization

Our newly developed GuiltyTargets method can be summarized as follows (Figure 1): First, a genome-wide PPI network is compiled and annotated with discretized information about differential gene expression within a given disease context (-1 = underexpressed; 0 = no significant change; 1 = overexpressed). Next, the attributed network is embedded into an Euclidean space using Gat2Vec. Following a PU learning scheme known disease specific protein targets are assigned positive labels, and the

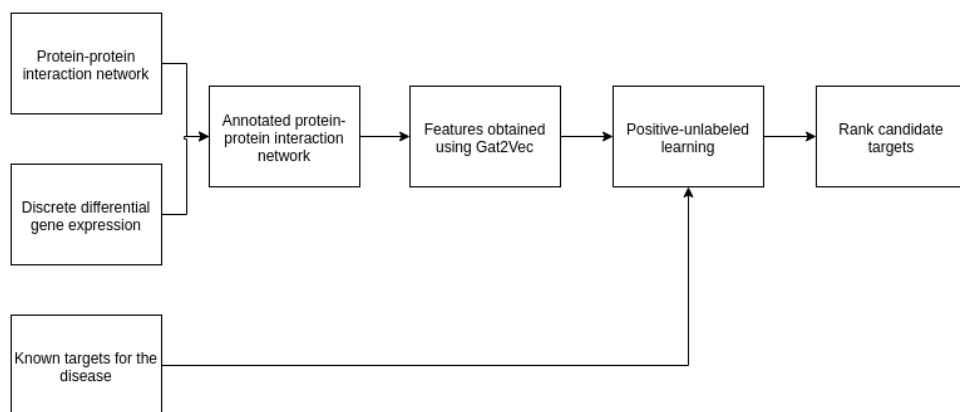

Fig 1. GuiltyTargets pipeline. First, a protein-protein interaction network is annotated with discrete differential gene expression information (up-regulated, down-regulated, not differentially expressed). 128 features are extracted from this annotated network using Gat2Vec. These features are input to a logistic regression algorithm where known targets are labeled as positive and the remaining as negative. The likelihoods that are calculated by the classifier is then used for ranking.

remaining proteins are regarded as pseudo-negatives to train a classifier that ranks a candidate protein according its similarity to known targets for the given disease. More details about GuiltyTargets are described in the Methods section of this paper.

Validation Data

We performed target prioritization analyses for six different diseases using corresponding gene expression data for acute myeloid leukemia, hepatocellular carcinoma, idiopathic pulmonary fibrosis, liver cirrhosis, multiple sclerosis and AD. The choice was made based on the following criteria: First, five of these diseases have also been evaluated in the publication by Emig *et al.* [10], which we used for comparison here. Second, the number of available known targets for each disease was expected to be relatively high for a statistically meaningful validation. Finally, we added AD to investigate the applicability of our approach to a highly challenging disease, in which so far most attempts to establish new drugs have failed [25]. Details about about used data, including pre-processing, are described in Materials and Methods Section. Notably, for AD we investigated RNASeq data from different cohorts (MSBB [26], MayoRNASeq [27], ROSMAP [28]). To investigate the prediction performance of GuiltyTargets we employed two protein-protein interaction networks (STRING [29], HIPPIE [30]), two target databases (Open Targets [18], Therapeutic Target Database [31]) and different cutoffs to discretize differential gene expression via \log_2 fold change thresholds (0.5, 1.0, 1.5) while requiring a false discovery rate of less than 5%.

GuiltyTargets Outperforms Existing Method

The performance of our approach and the method by Emig *et al.* were compared within a 10 times repeated 5-fold cross validation scheme with the area under ROC curve (AUROC) as the evaluation criterion. This assessed the ability of each method to rank in an independent test set a true known target higher than an unknown protein. For this purpose, the approach employed by Emig *et al.* was re-implemented using the same PPI network resources and target databases as for GuiltyTargets.

Disease	Emig <i>et al.</i> (original)	Emig <i>et al.</i>	GuiltyTargets
Acute myeloid leukemia	0.8195	0.8356 ± 0.0001	0.9277 ± 0.0002
Alzheimer's disease	-	0.6235 ± 0.0010	0.9418 ± 0.0004
Hepatocellular carcinoma	0.8019	0.7314 ± 0.0002	0.9384 ± 0.0001
Idiopathic pulmonary fibrosis	0.8826	0.8306 ± 0.0018	0.9263 ± 0.0004
Liver cirrhosis	0.6747	0.5338 ± 0.0019	0.9464 ± 0.0002
Multiple sclerosis	0.7151	0.6755 ± 0.0002	0.9412 ± 0.0003

Table 1. Ranking performance of GuiltyTargets compared to the method by Emig *et al.* in terms of cross-validated AUROC (standard error). The table shows the results when using Open Targets as resource for drug targets, STRING (using the default confidence threshold) as PPI network and declaring differential gene expression based on log₂ fold change cutoff of 1.5, which is agreement to Emig *et al.* The column “Reported” shows the AUROC values reported by Emig *et al.* and the column “Implemented” shows the AUROC values obtained by the reimplementation of their method. The row “Alzheimer’s Disease” refers to the MayoRNAseq data from temporal cortex, which among all tested AD gene expression datasets showed genes with an absolute log₂ fold change larger than 1.5.

Results shown in Tables 1, S1 and S2 demonstrate a dramatic performance increase of up to 40% by GuiltyTargets compared to the method by Emig *et al.*. Notably, AUROC values found by our re-implementation of were not identical (but typically close) to the ones reported in the original paper. This was likely due to the fact that not the same PPI network and target database resources have been used. More specifically, Emig *et al.* employed the commercial MetaBase™ database, whereas here we only rely on public resources.

We employed an ANOVA to assess the statistical significances of our findings. The ANOVA model was built separately for each investigated scenario (PPI network, target database, log₂ fold change cutoff) with three factors: method, dataset and an interaction term between method and dataset. The ANOVA F-test confirmed a highly significant improvement of GuiltyTargets compared to the method by Emig *et al.* for each disease and scenario ($p < 0.001$ after Holm’s correction for multiple testing, see Figure 2). As expected there was a highly significant dataset dependency of AUROC performance in every case ($p < 2.2e - 16$). Post-hoc analysis using Tukey’s multiple comparisons of means revealed that, on average, GuiltyTargets outperformed the approach by Emig *et al.* by 14.8% AUROC.

In-Depth Analysis of Influence Factors on GuiltyTargets Performance

We wanted to better understand the dependency of the performance of GuiltyTargets on the different tested influence factors, which we had varied individually in our cross-validation analysis:

- PPI network (STRING, HIPPIE), including different confidence level thresholds
- Target database (Open Targets, Therapeutic Targets Database)
- Thresholds for declaring differential gene expression

For this purpose we fitted a two-way ANOVA model with interaction term (influence factor, dataset, interaction term between both) and then performed a Tukey post-hoc analysis. Table 2 demonstrates that the employed PPI network is the most relevant influence factor for GuiltyTargets: Using STRING significantly increased the AUROC compared to using HIPPIE by 9%. On the other hand, the chosen log₂ fold change

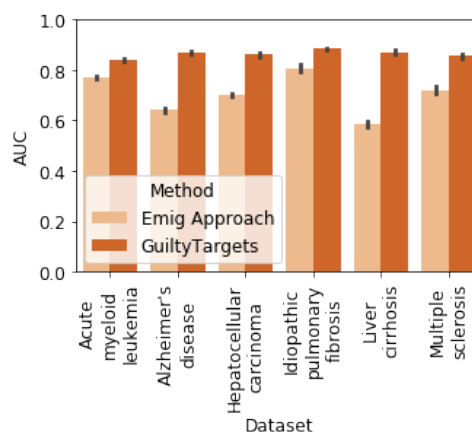

Fig 2. frohlich: Please change legend: Comparison of GuiltyTargets vs approach by Emig *et al.*: The barplots show AUC values averaged over all possible hyper-parameter choices (log2 fold change cutoff, target database, PPI network, PPI network confidence cutoff).

Influence factor	Comparison	Difference	p-value
PPI network	STRING vs. HIPPIE	0.09	1.15E-14
PPI confidence threshold	default vs 0.63	0.0318	1.15E-14
Target database	Open Targets vs. TTD	0.0527	2.23E-10
Log2 fold change cutoff	0.5 vs 1.0	-0.0016	0.01369
	1.0 vs 1.5	0.0007	0.46799
		0.0023	0.00026

Table 2. In-depth analysis of different influence factors on the performance of GuiltyTargets. The table shows the result of the Tukey ANOVA post-hoc analysis of different comparisons. The difference in AUROC is shown in column 3 together with the corresponding p-value in column 4.

threshold had almost no influence, i.e. GuiltyTargets is highly robust against this parameter. A more conservative confidence threshold for the STRING network yielded a drop in prediction performance by 3%. Both findings together may be explained by a comparably strong influence of the network topology for GuiltyTargets, which is leveraged by Gat2Vec. An obvious question is therefore, in how far GuiltyTargets is affected at all by gene expression data or whether our method is purely topology based. We thus compared the performance of our method across the three tested AD gene expression datasets (MSBB, MayoRNASeq, ROSMAP), confirming a significant influence of the actually used dataset on the AUROC for this particular disease ($p = 3.09E - 09$, ANOVA F-test). Hence, gene expression data does have a clear effect on GuiltyTargets.

The use of the Open Targets versus the Therapeutic Target Database significantly increased the ranking performance of GuiltyTargets by 5%, hence underlining the relevance of a larger number of known targets for learning the ranking model in the embedded network space.

GuiltyTargets Learns from Known Targets

We tested, whether the good performance of GuiltyTargets was dependent on known targets or whether also with a random set of proteins a similar performance could have been achieved. For this purpose we trained GuiltyTargets for each disease with 100 randomly drawn sets of targets of the same size as the actual ones, which we

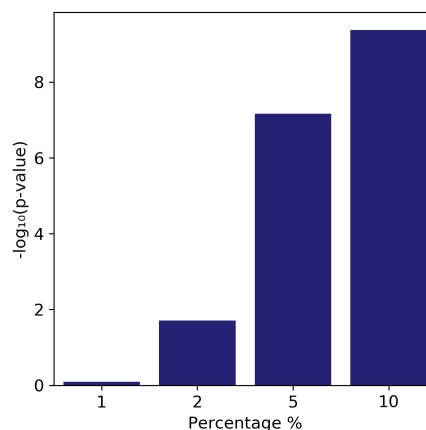

Fig 3. Target repositioning potential of GuiltyTargets: The barplot shows the result of a hypergeometric test conducted on the top p% of a ranked list of candidate proteins when looking for overrepresentation of known AD targets. GuiltyTargets was trained without any known AD targets here.

incorrectly labeled as “targets”. Prediction performance was evaluated using the same cross-validation procedure as before. Table S3 confirms that the AUROC for random proteins drops to about 50%, i.e. chance level. Hence, GuiltyTargets indeed learns properties of known targets.

GuiltyTargets Allows for Target Repositioning Across Related Diseases

There is the question whether GuiltyTargets could transfer properties learned from known targets in one disease area into another one, hence allowing for repositioning of targets. To address that question we trained GuiltyTargets with all known targets of neurodegenerative diseases obtained from Open Targets, while excluding known AD targets. We then ran a hypergeometric test on the resulting prioritization to see if known AD targets were statistically overrepresented at the top of the list. The results were significant when at least 2% of the top candidates were considered (Figure 3). This shows that GuiltyTargets could help for repositioning targets across related disease areas.

Case Study: GuiltyTargets Predicts New Candidate Targets for Alzheimer’s Disease

Despite of 180 therapeutic targets listed in the Open Targets database, the AD field urgently requires new and more effective medications that either prevent, mitigate, or reverse its progression. This is particularly true, because the vast majority of drugs under development fail in clinical trials [25]. We here picked out AD as a test case for GuiltyTargets to prioritize new target candidates. We used post-mortem gene expression data from brain tissue from the ROSMAP study and combined it with STRING based PPI network and Open Targets as a resource for known targets. ROSMAP data was chosen because of its comparably large number of samples (495 AD patients and 438 controls). Table 3 shows the top 0.1% of a ranked list of novel candidate targets (likelihood score > 0.4) obtained with GuiltyTargets. According to the TTD [31] and

Entrez identifier	HGNC symbol	Likelihood score	Class	Known drugs / druggable
1143	CHRNA4	0.7	Nicotinic acetylcholine receptor	SIB-1553A (Alzheimer, discontinued in Phase 2)
3708	ITPR1	0.689	IP3 receptor	yes
2742	GLRA2	0.619	Ligand gated chloride channel	yes
1312	COMT	0.587	Catechol-O-Methyltransferase	Tolcapone (Parkinson)
2898	GRIK2	0.587	Ionotropic glutamate receptor	yes
1132	CHRM4	0.586	Muscarinic acetylcholine receptor	yes
89832	CHRFAM7A	0.557	Nicotinic acetylcholine receptor	yes
3363	HTR7	0.532	Serotonin receptor	JNJ-18038683(Major depressive disorder)
3777	KCNK3	0.523	Potassium channel	ATI-9242 (Schizophrenia, discontinued in Phase 2)
2741	GLRA1	0.484	Glycine receptor	D-Serine(Parkinson's disease, Phase 4)
1136	CHRNA3	0.461	Nicotinic acetylcholine receptor	yes
				Doxepin(Depression)
3269	HRH1	0.451	Histamine receptor	Doxylamine(Anxiety disorder)
				Propiomazine(Insomnia, Anxiety disorder)]
				Pyrilamine Maleate(headache)
6543	SLCSA2	0.448	Solute carrier	
2911	GRM1	0.447	Metabotropic glutamate receptor	PF-1913539 (Alzheimer's disease, discontinued in Phase 3)
				A-841720 (Pain, preclinical)
				AZD8529 (Schizophrenia, discontinued in Phase 2)
				BCI-632 (Alzheimer disease, Major depressive disorder, Phase 1)
				Pomaglumetad (Schizophrenia, Phase 1)
2913	GRM3	0.445	Metabotropic glutamate receptor	LY-544344 (Anxiety disorder, Discontinued in Phase 3)
				LY354740 (Anxiety disorder, Discontinued in Phase 2)
				R-1578 (Mood disorder, Discontinued in Phase 2)
				RO-4995819 (Major depressive disorder, Discontinued in Phase 2)
3361	HTR5A	0.436	Serotonin receptor	yes
8001	GLRA3	0.412	Ligand gated chloride channel	yes
1360	CPB1	0.411	Protaminase	yes
9456	HOMER1	0.407	Neuronal immediate-early gene	yes

Table 3. Target prioritization for AD using ROSMAP gene expression data. This list shows candidate proteins above a likelihood score threshold of 0.4. The last column shows either known drugs (including indications) against the respective target or the classification as “druggable” using the information from DGIdb [32] and TTD [31].

DGIdb [32] databases, all but two candidates are druggable, thus they could be used as targets for drugs using the current drug development methods.

Many of the candidate targets are receptors, namely four acetylcholine receptors (three nicotinic, one muscarinic), and three glutamate receptors (two metabotropic, one ionotropic), in agreement with the observation that receptors constitute a large portion of known AD targets for small molecule drugs [33]. The remaining candidates were identified as ion channels. The top candidate (CHRNA4) is the target of the compound SIB-1553A, which has been tested in a phase 2 clinical trial for AD, but discontinued (source: Therapeutic Target Database). Out of the other top candidates we found CHRFAM7A, GRM1, GRM3, ITPR1, HTR7, and COMT particularly interesting: CHRFAM7A is an alpha-7 nicotinic cholinergic receptor subunit interacting with amyloid β , whose aggregates (i.e., plaques) are one of the hallmarks of AD [34]. CHRFAM7A may promote neuronal survival and function, and subunits are expressed by astrocytes participating in synaptic communication [35]. GRM1 is the target of the compound PF-1913539, which has been discontinued in a phase 3 AD trial [31]. GRM3 (mGlu3) is found in astrocytes as well as neuronal cells, and have been observed to have neuroprotective properties. Its agonists and positive allosteric modulators were reported to be potentially helpful for AD treatment [36]. Glial mGlu3 receptors regulate the production of neurotrophic factors such as nerve growth factor, brain-derived neurotrophic factor and glial-derived neurotrophic factor [36]. BCI-632, a compound that targets GRM3, is currently tested in a phase 1 AD trial [31]. ITPR1, an intracellular Ca^{2+} channel, mediates calcium release from the endoplasmic reticulum, triggering apoptosis, and its deletion has been linked to spinocerebellar ataxia type 15, a neurodegenerative disease [37, 38]. Single nucleotide polymorphisms (SNPs) rs73310256 in HTR7 [39] and rs4680 in COMT have been associated with AD [40]. COMT is currently discussed as a target for AD [41]. Finally, COMT is the target of the anti-Parkinson drug Tolcapone (source: TTD), supporting our previous finding that GuiltyTargets can re-propose targets from related diseases.

Visualization of interactions between known and candidate targets (Figure 4) revealed that the network of known and proposed targets has a higher than expected interaction rate (PPI enrichment $p < 1.0E - 16$, calculated using STRING web interface). Further-

(including the one by Emig *et al.*) learn properties of known targets to rank candidate proteins. Hence, these approaches rely on available information about targets, which is often incomplete and noisy [43]. Because of their dependency on available data machine learning approaches typically have difficulties to propose candidates that point towards completely novel disease biology. Despite these limitations GuiltyTargets showed promising results for target prioritization, including our case study for AD. Hence, we see GuiltyTargets as a promising tool to support the decision process in the context of target identification in pharmaceutical research.

Materials and Methods

Information Sources

Three types of information sources were used for target prioritization:

1. differential gene expression profiles between diseased and healthy subjects
2. protein-protein interaction networks (PPI network)
3. disease-specific target annotation

In the following we provide more detailed information about these data.

Gene Expression Data

Gene expression data for acute myleoid leukemia, hepatocellular carcinoma, idiopathic pulmonary fibrosis, liver cirrhosis and multiple sclerosis was obtained from Gene Expression Omnibus (GEO) [44], and differential gene expression was assessed via GEO2R [45], Biobase [46], GEOquery [47] and limma [48] using multiple testing correction via the false discovery rate [49] (see: Supplementary Table 1).

For AD, RNASeq data from the AM-PAD Knowledge Portal (AM-PAD) was used [50]. In particular, MSBB, ROSMAP, and MayoRNASeq studies were utilized. Differential gene expression was assessed by applying DESeq2 to the normalized RNAseq data for each brain region (Table S4).

Protein-Protein Interaction Networks

As PPI networks, HIPPIE v2.0 [30] and STRING v10.5 [29] were used since both of these networks are created by combining multiple sources of PPIs and provide confidence scores. HIPPIE and STRING differ in the type of interactions they contain (Table S5): HIPPIE relies on physical protein-protein interactions, whereas STRING captures more broadly functional interactions. Hence, STRING has a much larger size than HIPPIE. The analyses on this paper only included the interactions between human proteins. STRING locus identifiers were mapped to Entrez identifies using the mappings provided by STRING.

Target Databases

Information about known targets were obtained from two databases: The Therapeutic Target Database (TTD) [31] and Open Targets [18] (see: Table S6). Target identifiers in TTD database were mapped to UniProt identifiers using the conversion file provided by TTD. These identifiers were then mapped to Entrez gene IDs using R packages AnnotationDBI [51] and org.Hs.eg.db [52]. In addition to TTD, known protein targets were retrieved from Open Targets. HGNC symbols were converted to Entrez identifiers using R packages AnnotationDBI [51] and org.Hs.eg.db [52].

GuiltyTargets

Deep Network Representation Learning

GuiltyTargets relies on a deep representation learning of an annotated PPI network via Gat2Vec, where node attributes represent discretized gene expression log fold changes (see Results part). In a first step, two separate graphs, the structural and the attribute graph, are constructed from the original labeled PPI network, where the structural graph corresponds to the PPI network, and the attribute graph is a bipartite graph between protein nodes and discretized log fold changes. Afterwards Gat2Vec retrieves for each vertex its structural context through random walks of a predefined length. The exact parameters that we used to run Gat2Vec are given in Table S7. The result of each random walk is a sequence of vertices and node attributes, respectively. These sequences are subsequently embedded into an Euclidean space using a SkipGram neural network, which is an essential part of the well known Word2Vec method [53].

Target Candidate Ranking

The features obtained from annotated PPI networks and the disease-specific target annotations were used to train a logistic regression classifier. Following a PU learning scheme known targets were assigned positive labels, and the remaining proteins were treated as if they were negatives. It is essential to note that proteins that are not known as targets in a particular disease of interest could in fact be targets in another disease context, and finding them is the primary goal target prioritization approaches. For the implementation, the LogisticRegression class from linear_model module and OneVsRestClassifier class from multiclass module in Python library scikit-learn were used [54].

Funding

This work was supported by Fraunhofer-Gesellschaft.

Acknowledgements

We would like to thank Daniel Domingo-Fernández for his valuable help in interpreting the ranked candidate list for Alzheimer's disease.

The results published here are in part based on data obtained from the AMP-AD Knowledge Portal (doi 10.7303/syn2580853).

For MSBB data set, these data were generated from postmortem brain tissue collected through the Mount Sinai VA Medical Center Brain Bank and were provided by Dr. Eric Schadt from Mount Sinai School of Medicine.

For MayoRNASeq data set, study data were provided by the following sources: The Mayo Clinic Alzheimer's Disease Genetic Studies, led by Dr. Nilufer Taner and Dr. Steven G. Younkin, Mayo Clinic, Jacksonville, FL using samples from the Mayo Clinic Study of Aging, the Mayo Clinic Alzheimer's Disease Research Center, and the Mayo Clinic Brain Bank. Data collection was supported through funding by NIA grants P50 AG016574, R01 AG032990, U01 AG046139, R01 AG018023, U01 AG006576, U01 AG006786, R01 AG025711, R01 AG017216, R01 AG003949, NINDS grant R01 NS080820, CurePSP Foundation, and support from Mayo Foundation. Study data includes samples collected through the Sun Health Research Institute Brain and Body Donation Program of Sun City, Arizona. The Brain and Body Donation Program is supported by the National Institute of Neurological Disorders and Stroke (U24 NS072026 National Brain and Tissue Resource for Parkinsons Disease and Related Disorders), the National Institute on Aging

(P30 AG19610 Arizona Alzheimer's Disease Core Center), the Arizona Department of Health Services (contract 211002, Arizona Alzheimer's Research Center), the Arizona Biomedical Research Commission (contracts 4001, 0011, 05- 901 and 1001 to the Arizona Parkinson's Disease Consortium) and the Michael J. Fox Foundation for Parkinson's Research.

For ROSMAP data set, study data were provided by the Rush Alzheimer's Disease Center, Rush University Medical Center, Chicago. Data collection was supported through funding by NIA grants P30AG10161, R01AG15819, R01AG17917, R01AG30146, R01AG36836, U01AG32984, U01AG46152, the Illinois Department of Public Health, and the Translational Genomics Research Institute.

Author contributions statement

Ö.M. and C.T.H. implemented the method and analysed data. M.H.-A. and H.F. designed the research. H.F. supervised the project. Ö.M., C.T.H. and H.F. drafted the manuscript.

Competing Interests statement

H.F. received salaries from UCB Biosciences GmbH. UCB Biosciences GmbH had no influence on the content of this work.

References

1. Csermely P, Korcsmáros T, Kiss HJ, London G, Nussinov R. Structure and dynamics of molecular networks: a novel paradigm of drug discovery: a comprehensive review. *Pharmacology & therapeutics*. 2013;138(3):333–408.
2. Gashaw I, Ellinghaus P, Sommer A, Asadullah K. What makes a good drug target? *Drug discovery today*. 2011;16(23-24):1037–1043.
3. Hughes JP, Rees S, Kalindjian SB, Philpott KL. Principles of early drug discovery. *British journal of pharmacology*. 2011;162(6):1239–1249.
4. Lotfi Shahreza M, Ghadiri N, Mousavi SR, Varshosaz J, Green JR. A review of network-based approaches to drug repositioning. *Briefings in bioinformatics*. 2017;.
5. Arrowsmith J. Trial watch: Phase II failures: 2008–2010; 2011.
6. Laenen G, Thorrez L, Börnigen D, Moreau Y. Finding the targets of a drug by integration of gene expression data with a protein interaction network. *Molecular BioSystems*. 2013;9(7):1676–1685.
7. Arrowsmith J. Phase III and submission failures: 2007-2010. *Nature Reviews Drug Discovery*. 2011;10(2):1–2.
8. Isik Z, Baldow C, Cannistraci CV, Schroeder M. Drug target prioritization by perturbed gene expression and network information. *Scientific reports*. 2015;5:17417.
9. L Moseley F, Bicknell K, S Marber M, Brooks G. The use of proteomics to identify novel therapeutic targets for the treatment of disease. *The Journal of pharmacy and pharmacology*. 2007;59:609–28. doi:10.1211/jpp.59.5.0001.

10. Emig D, Ivliev A, Pustovalova O, Lancashire L, Bureeva S, Nikolsky Y, et al. Drug target prediction and repositioning using an integrated network-based approach. *PLoS One*. 2013;8(4):e60618.
11. Doyle MA, Gasser RB, Woodcroft BJ, Hall RS, Ralph SA. Drug target prediction and prioritization: using orthology to predict essentiality in parasite genomes. *BMC genomics*. 2010;11(1):222.
12. Paul MS, Kaur A, Geete A, Sobhia ME. Essential gene identification and drug target prioritization in *Leishmania* species. *Molecular BioSystems*. 2014;10(5):1184–1195.
13. Gupta SK, Gross R, Dandekar T. An antibiotic target ranking and prioritization pipeline combining sequence, structure and network-based approaches exemplified for *Serratia marcescens*. *Gene*. 2016;591(1):268–278.
14. Yeh SH, Yeh HY, Soo VW. A network flow approach to predict drug targets from microarray data, disease genes and interactome network-case study on prostate cancer. *Journal of clinical bioinformatics*. 2012;2(1):1.
15. Vitali F, Cohen LD, Demartini A, Amato A, Eterno V, Zambelli A, et al. A network-based data integration approach to support drug repurposing and multi-target therapies in triple negative breast cancer. *PloS one*. 2016;11(9):e0162407.
16. Bidkhorji G, Benfeitas R, Elmas E, Kararoudi MN, Arif M, Uhlen M, et al. Metabolic Network-Based Identification and Prioritization of Anticancer Targets Based on Expression Data in Hepatocellular Carcinoma. *Frontiers in physiology*. 2018;9.
17. Keane H, Ryan BJ, Jackson B, Whitmore A, Wade-Martins R. Protein-protein interaction networks identify targets which rescue the MPP+ cellular model of Parkinson's disease. *Scientific reports*. 2015;5:17004.
18. Koscielny G, An P, Carvalho-Silva D, Cham JA, Fumis L, Gasparyan R, et al. Open Targets: a platform for therapeutic target identification and validation. *Nucleic acids research*. 2016;45(D1):D985–D994.
19. Ferrero E, Dunham I, Sanseau P. In silico prediction of novel therapeutic targets using gene-disease association data. *Journal of translational medicine*. 2017;15(1):182.
20. Sheikh N, Kefato Z, Montresor A. gat2vec: representation learning for attributed graphs. *Computing*. 2018; p. 1–23.
21. Li XL, Liu B. Learning from positive and unlabeled examples with different data distributions. In: *European Conference on Machine Learning*. Springer; 2005. p. 218–229.
22. Peng L, Zhu W, Liao B, Duan Y, Chen M, Chen Y, et al. Screening drug-target interactions with positive-unlabeled learning. *Scientific Reports*. 2017;7(1):8087.
23. Hameed PN, Verspoor K, Kusljic S, Halgamuge S. Positive-unlabeled learning for inferring drug interactions based on heterogeneous attributes. *BMC bioinformatics*. 2017;18(1):140.
24. Yang P, Li XL, Mei JP, Kwok CK, Ng SK. Positive-unlabeled learning for disease gene identification. *Bioinformatics*. 2012;28(20):2640–2647.

25. Mehta D, Jackson R, Paul G, Shi J, Sabbagh M. Why do trials for Alzheimer's disease drugs keep failing? A discontinued drug perspective for 2010-2015. *Expert opinion on investigational drugs*. 2017;26(6):735–739.
26. Wang M, Beckmann ND, Roussos P, Wang E, Zhou X, Wang Q, et al. The Mount Sinai cohort of large-scale genomic, transcriptomic and proteomic data in Alzheimer's disease. *Scientific data*. 2018;5:180185.
27. Allen M, Carrasquillo MM, Funk C, Heavner BD, Zou F, Younkin CS, et al. Human whole genome genotype and transcriptome data for Alzheimer's and other neurodegenerative diseases. *Scientific data*. 2016;3:160089.
28. Mostafavi S, Gaiteri C, Sullivan SE, White CC, Tasaki S, Xu J, et al. A molecular network of the aging human brain provides insights into the pathology and cognitive decline of Alzheimer's disease. *Nature neuroscience*. 2018;21(6):811.
29. Szklarczyk D, Morris JH, Cook H, Kuhn M, Wyder S, Simonovic M, et al. The STRING database in 2017: quality-controlled protein–protein association networks, made broadly accessible. *Nucleic acids research*. 2016; p. gkw937.
30. Alanis-Lobato G, Andrade-Navarro MA, Schaefer MH. HIPPIE v2. 0: enhancing meaningfulness and reliability of protein–protein interaction networks. *Nucleic acids research*. 2016; p. gkw985.
31. Li YH, Yu CY, Li XX, Zhang P, Tang J, Yang Q, et al. Therapeutic target database update 2018: enriched resource for facilitating bench-to-clinic research of targeted therapeutics. *Nucleic acids research*. 2017;46(D1):D1121–D1127.
32. Cotto KC, Wagner AH, Feng YY, Kiwala S, Coffman AC, Spies G, et al. DGIdb 3.0: a redesign and expansion of the drug–gene interaction database. *Nucleic Acids Research*. 2018;46(D1):D1068–D1073. doi:10.1093/nar/gkx1143.
33. Santos R, Ursu O, Gaulton A, Bento AP, Donadi RS, Bologa CG, et al. A comprehensive map of molecular drug targets. *Nature reviews Drug discovery*. 2017;16(1):19.
34. Murpy M, LeVine III H. Alzheimer's disease and the β -amyloid peptide. *J Alzheimers Dis*. 2010;19(1):311–323.
35. Dineley KT, Pandya AA, Yakel JL. Nicotinic ACh receptors as therapeutic targets in CNS disorders. *Trends in pharmacological sciences*. 2015;36(2):96–108.
36. Caraci F, Battaglia G, Sortino MA, Spampinato S, Molinaro G, Copani A, et al. Metabotropic glutamate receptors in neurodegeneration/neuroprotection: still a hot topic? *Neurochemistry international*. 2012;61(4):559–565.
37. Hara K, Shiga A, Nozaki H, Mitsui J, Takahashi Y, Ishiguro H, et al. Total deletion and a missense mutation of ITPR1 in Japanese SCA15 families. *Neurology*. 2008;71(8):547–551.
38. Van de Leemput J, Chandran J, Knight MA, Holtzclaw LA, Scholz S, Cookson MR, et al. Deletion at ITPR1 underlies ataxia in mice and spinocerebellar ataxia 15 in humans. *PLoS genetics*. 2007;3(6):e108.
39. Herold C, Hooli BV, Mullin K, Liu T, Roehr JT, Mattheisen M, et al. Family-based association analyses of imputed genotypes reveal genome-wide significant association of Alzheimer's disease with OSBPL6, PTPRG, and PDCL3. *Molecular psychiatry*. 2016;21(11):1608.

40. Corbo RM, Gambina G, Broggio E, Scarabino D, Scacchi R. Association study of two steroid biosynthesis genes (COMT and CYP17) with Alzheimer's disease in the Italian population. *Journal of the neurological sciences*. 2014;344(1-2):149–153.
41. Perkovic MN, Strac DS, Tudor L, Konjevod M, Erjavec GN, Pivac N. Catechol-O-methyltransferase, Cognition and Alzheimer's Disease. *Current Alzheimer Research*. 2018;15(5):408–419.
42. Dongen S. A cluster algorithm for graphs. 2000;.
43. Zakeri P, Simm J, Arany A, ElShal S, Moreau Y. Gene prioritization using Bayesian matrix factorization with genomic and phenotypic side information. *Bioinformatics*. 2018;34(13):i447–i456.
44. Edgar R, Domrachev M, Lash AE. Gene Expression Omnibus: NCBI gene expression and hybridization array data repository. *Nucleic acids research*. 2002;30(1):207–210.
45. Barrett T, Wilhite SE, Ledoux P, Evangelista C, Kim IF, Tomashevsky M, et al. NCBI GEO: archive for functional genomics data sets—update. *Nucleic acids research*. 2012;41(D1):D991–D995.
46. Huber W, Carey VJ, Gentleman R, Anders S, Carlson M, Carvalho BS, et al. Orchestrating high-throughput genomic analysis with Bioconductor. *Nature methods*. 2015;12(2):115.
47. Davis S, Meltzer PS. GEOquery: a bridge between the Gene Expression Omnibus (GEO) and BioConductor. *Bioinformatics*. 2007;23(14):1846–1847.
48. Ritchie ME, Phipson B, Wu D, Hu Y, Law CW, Shi W, et al. limma powers differential expression analyses for RNA-sequencing and microarray studies. *Nucleic acids research*. 2015;43(7):e47–e47.
49. Benjamini Y, Hochberg Y. Controlling the false discovery rate: a practical and powerful approach to multiple testing. *Journal of the royal statistical society Series B (Methodological)*. 1995; p. 289–300.
50. Hodes RJ, Buckholtz N. Accelerating medicines partnership: Alzheimer's disease (AMP-AD) knowledge portal aids Alzheimer's drug discovery through open data sharing; 2016.
51. Carlson M, Falcon S, Pages H, Li N. AnnotationDbi: Annotation Database Interface. R package version;1(0).
52. Carlson M, Falcon S, Pages H, Li N. org. Hs. eg. db: Genome wide annotation for Human. R package version 33. 2013;.
53. Mikolov T, Chen K, Corrado G, Dean J. Efficient estimation of word representations in vector space. arXiv preprint arXiv:13013781. 2013;.
54. Pedregosa F, Varoquaux G, Gramfort A, Michel V, Thirion B, Grisel O, et al. Scikit-learn: Machine Learning in Python. *Journal of Machine Learning Research*. 2011;12:2825–2830.

Postface

The exchange of engineered topological features for learned features increased the performance in target prioritization across nearly all combinations of protein-protein interaction databases (i.e., HIPPIE and STRING), disease-target association databases (i.e., Therapeutic Target Database and OpenTargets), and other hyperparameters used in the workflow from Emig *et al.* [120].

The work of Emig *et al.* was careful to validate using a variety of diseases that were well understood. Following validation and comparison to Emig *et al.*, this publication turns towards applications to neurodegenerative disease—an indication notorious for poor choice of target proteins during drug discovery. The most infamous is the amyloid beta precursor protein due to the ubiquity of aggregates of its cleavage products, $A\beta_{40}$ and $A\beta_{42}$ in the brains of AD patients. However, all clinical trials until this point targeting this protein have failed. GuiltyTargets proposed new targets that have not been previously clinically investigated in the context of AD such as CHRN4, a nicotinic receptor subunit for which there is mounting epidemiological evidence of the importance in the disease.

While GuiltyTargets comprises a machine learning pipeline for node-based prioritization of targets in knowledge graphs, future work will incorporate other sources for automatically contextualizing these targets with their related drug-gability, side effects, and clinical trial landscape. The same workflow in which NRL is used to replace topological features could be used to improve upon previous drug repositioning efforts such as [148]. While initial work used the same protein-protein interaction networks and disease-specific differential gene expression profiles, it can be extended to accommodate the rich knowledge encoded in BEL networks generated by manual, semi-automated, and automated approaches described elsewhere in this thesis. Several respective master's theses found at <https://github.com/lingling93/comparison>, https://github.com/aldisirana/SE_KGE, and <http://github.com/guiltytargets/phewas> are in progress investigating these questions. Future work could also easily incorporate the networks arising from Bio2BEL packages presented in Chapter 5.

8

A systematic approach for identifying shared mechanisms in epilepsy and its comorbidities

Preface

The epidemiological evidence of comorbidity between Alzheimer's disease and epilepsy motivated further investigation of their potential shared molecular mechanisms of pathogenesis. These shared mechanisms present opportunities for transferring knowledge in one domain to another and lead to obvious drug repositioning mechanisms for compounds tested for one indication that affects a pathway shared by another indication.

The final publication in this thesis describes the curation of a disease-specific knowledge assembly for epilepsy, its categorization into signatures in NeuroMM-Sig [131], and the development and application of the comparative mechanism enrichment workflow to identify shared molecular mechanisms with AD. It presents an application scenario in which a knowledge-driven approach was used to hypothesize shared pathways between epilepsy and AD that might be affected by the drug, carbamazepine, which has been observed through epidemiological studies to have positive therapeutic benefits in both disease contexts.

Reprinted with permission from "Hoyt, C. T., *et al.* (2018). A systematic approach for identifying shared mechanisms in epilepsy and its comorbidities.

Database, 2018(1)". Copyright © Hoyt, C.T., et al., 2018.



Original article

A systematic approach for identifying shared mechanisms in epilepsy and its comorbidities

Charles Tapley Hoyt^{1,2,*}, Daniel Domingo-Fernández^{1,2,†}, Nora Balzer², Anka Güldenpfennig¹ and Martin Hofmann-Apitius^{1,2}

¹Department of Bioinformatics, Fraunhofer Institute for Algorithms and Scientific Computing, Konrad-Adenauer-Straße, Schloss Birlinghoven, 53754 Sankt Augustin, Germany and ²Department of Life Science Informatics, Bonn-Aachen International Center for IT, Rheinische Friedrich-Wilhelms-Universität Bonn, Endenicher Allee 19C, Bonn 53113, Germany

*Corresponding author: Tel: +49 2241 14-2268; Fax: +49 2241 14-2656; Email: charles.hoyt@scai.fraunhofer.de

†These authors contributed equally to this work.

Citation details: Hoyt, C.T., Domingo-Fernández, D., Balzer, N. *et al.* A systematic approach for identifying shared mechanisms in epilepsy and its comorbidity. *Database* (2018) Vol. 2018: article ID bay050; doi:10.1093/database/bay050

Received 9 February 2018; Revised 23 April 2018; Accepted 26 April 2018

Abstract

Cross-sectional epidemiological studies have shown that the incidence of several nervous system diseases is more frequent in epilepsy patients than in the general population. Some comorbidities [e.g. Alzheimer's disease (AD) and Parkinson's disease] are also risk factors for the development of seizures; suggesting they may share pathophysiological mechanisms with epilepsy. A literature-based approach was used to identify gene overlap between epilepsy and its comorbidities as a proxy for a shared genetic basis for disease, or genetic pleiotropy, as a first effort to identify shared mechanisms. While the results identified neurological disorders as the group of diseases with the highest gene overlap, this analysis was insufficient for identifying putative common mechanisms shared across epilepsy and its comorbidities. This motivated the use of a dedicated literature mining and knowledge assembly approach in which a cause-and-effect model of epilepsy was captured with Biological Expression Language. After enriching the knowledge assembly with information surrounding epilepsy, its risk factors, its comorbidities, and anti-epileptic drugs, a novel comparative mechanism enrichment approach was used to propose several downstream effectors (including the GABA receptor, GABAergic pathways, etc.) that could explain the therapeutic effects carbamazepine in both the contexts of epilepsy and AD. We have made the Epilepsy Knowledge Assembly available at <https://www.scai.fraunhofer.de/content/dam/scai/de/downloads/bioinformatik/epilepsy.bel> and queryable through NeuroMMSig at <http://neurommsig.scai.fraunhofer.de>. The source code used for analysis and tutorials for reproduction are available on GitHub at <https://github.com/cthoht/epicom>.

Introduction

Seizures are transient occurrences of signs and symptoms due to abnormal or excessive neuronal activity in the brain (1). Classically, their underlying causes were thought to be the primary drivers for increasing mortality in epilepsy. While epilepsy has been classically studied as a disorder of the brain characterized by an enduring pre-disposition to epileptic seizures, it is no longer considered a condition in which seizures are the only concern (2). Epilepsy is also associated with several comorbidities, including Alzheimer's disease (AD), Parkinson's disease (PD), other nervous system diseases and psychiatric disorders (3–5), due to a variety of genetic, biological and environmental factors (6).

The prevalence of migraine in epilepsy patients (under 64 years old) is 5.71% in contrast to 3.47% in the general population (7). The mechanistic understanding of epilepsy and migraine presumes that they share the underlying pathophysiology related to alterations in sodium and calcium ion channels and ion transporters (sodium-potassium transport; 8, 9). Moreover, drugs acting on voltage-gated sodium channels and γ -aminobutyric acid (GABA) receptors (e.g. valproate, topiramate, etc.) are used not only prevent migraine attacks, but are also used as anti-epileptic drugs (10, 11).

The prevalence of epileptic seizures in AD patients is strongly influenced by genetic factors (12)—epilepsy and seizures occur more often in patients with early-onset familial AD than those with sporadic AD (13). Further, convulsive seizures have been described in approximately 40% of familial AD patients with the PSEN1 p.Glu280Ala mutation (14), 30% with PSEN2 mutations (15) and 57% with amyloid precursor protein (APP p.Thr174Ile) duplications (16). Additionally, the p.Pro86Lys mutation in CALHM1 (rs11191692) is associated with both AD and temporal lobe epilepsy through its influence on calcium homeostasis (17).

Evidence that some comorbidities (e.g. AD and depression) also act as risk factors for developing seizures suggests they may share pathophysiological mechanisms (13, 18). Conversely, epileptic seizures (as well as neoplasms) have been reported to cause intellectual disabilities in patients with tuberous sclerosis (19, 20). Furthermore, certain anti-epileptic drugs (e.g. topiramate) are associated with higher incidence of cognitive problems (1, 21).

The several causal and associative relationships observed between epilepsy and other indications on the phenotypic level warrant further investigation for shared elements on the genetic and molecular levels. While inquiry on the genetic level often begins with genome-wide association studies to identify shared loci, identifying the

appropriate data set(s) and linking intergenic single nucleotide polymorphisms (SNP) to their functional consequences across scales in complex disease is still a significant challenge (22). Even after identifying disease-associated genes, it is difficult to assess their individual contributions to the complex etiology of epilepsy and its related indications. Thus, capturing the different causal relationships between biological entities involved in the pathophysiology of a complex disease is an essential step to a better understanding of the processes that lead to the disease state.

Here, we present two methods to hypothesize shared mechanisms: first, a literature-based approach for quantifying gene overlap between epilepsy and its comorbidities as a proxy for a shared genetic basis of disease, or genetic pleiotropy; and second, a systematic approach using the NeuroMMSig mechanism enrichment server. Finally, we use these methods to propose an explanation for the observed therapeutic effects of a drug that has been studied in the contexts of epilepsy and AD. A schematic representation of the methodology, analysis and results is presented in Figure 1.

Materials and methods

Pre-processing of epidemiological studies

Epidemiological studies comparing the incidence of several comorbidities of epilepsy versus incidence in the general population were extracted from a recent review by Keezer *et al.* (23). The prevalence ratio, which describes the ratio of incidence of a given condition in epilepsy patients versus the general population, was calculated for each study.

Quantification of gene overlap

SCAIVIEW v1.7.3, indexed from MEDLINE on 2016-07-14, (<http://academia.scaiview.com/academia>) was used to identify and quantify the overlap of genes co-occurring in the literature with epilepsy and its novel and well-known comorbidities reviewed by Keezer *et al.* Three comorbidities were excluded from assessment by literature-based methods due to their poor correspondence with MeSH terms (i.e. allergic) or their lack of specificity (i.e. heart disease and neoplasms) by occurring too frequently and covering too many genes to be insightful. Finally, additional epidemiological comorbidity studies with PD were curated and included due to its previously published relevance (24).

In order to later assess publication bias in literature-based methods, the total number of documents associated with each disease was reported by querying SCAIVIEW

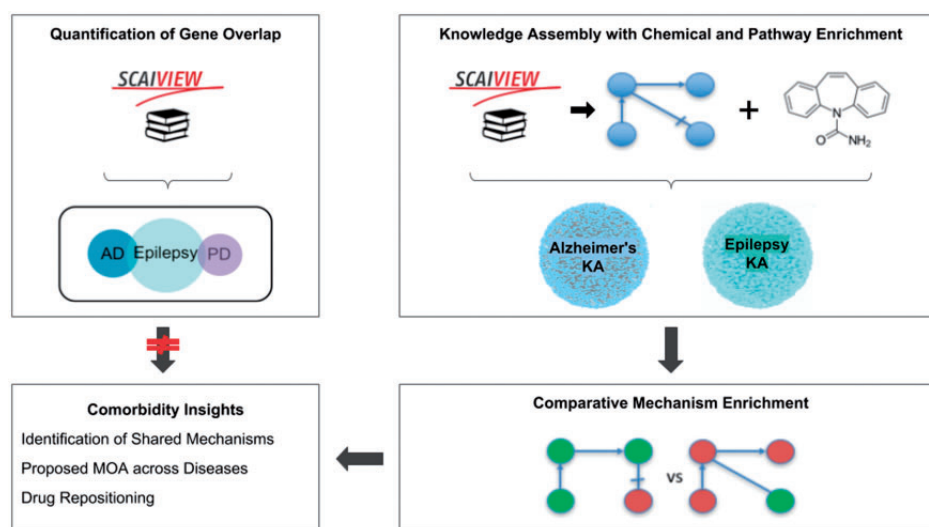

Figure 1. A graphical abstract of the methodology, analysis, and results presented in this work. The two upper boxes represent the methodology while the two lower boxes represent the analysis and results. The upper-left box outlines the quantification of gene overlap between epilepsy and its well-known comorbidities described in Keezer *et al.* (23; e.g. AD, PD, etc.) using literature based methods. The upper-right box outlines the assembly of knowledge from epilepsy literature with chemical and pathway enrichment as described in the 'Preparation for Mechanism Enrichment' and 'Relation Extraction' Sections. The lower-right box represents the comparative mechanism enrichment that was used to generate comorbidity insights (lower-left box) after literature-based methods proved insufficient.

with each disease's corresponding MeSH term. The total number of associated genes with each disease was counted by those with a positive relative entropy (i.e. occur more frequently in the results of a given SCAIView query than in the rest of the SCAIView indexed literature) in the context of the query as described by Younesi *et al.* (25). Gene sets for each comorbidity were then retrieved by constructing queries using their corresponding MeSH terms joined with the epilepsy MeSH term by the 'AND' operator. The associated genes for each comorbidity query were identified with the same method and the epilepsy pleiotropy rate was calculated as the percentage of the genes associated with the comorbidity query in the set of associated genes with epilepsy (Table 1).

For example, 226 genes were found to be associated with diabetes using the comorbidity query [MeSH Disease:"Epilepsy"] AND [MeSH Disease:"Diabetes Mellitus"]. Of these, 184 had positive relative entropies, which indicate that these genes occur more frequently in literature mentioning both diseases than in the rest of the SCAIView indexed literature. Finally, the epilepsy pleiotropy rate was calculated normalizing 184 by the total number of genes (2901) with a positive relative entropy found by querying for epilepsy [MeSH Disease:"Epilepsy"], resulting in an epilepsy pleiotropy rate of 6.34%.

Relation extraction

While literature co-occurrence can generate initial hypotheses about genetic pleiotropy, it does not provide sufficient mechanistic insight to explain the clinical observations in epilepsy and its comorbidities. The increasing quantity of knowledge in the biomedical domain makes it difficult or impossible for researchers to be knowledgeable in any but incredibly specific topics (26). The task of manually generating pleiotropy hypotheses that explain overlap between the aetiological mechanisms of epilepsy and its comorbidities is daunting. In order to enable computer-aided automatic reasoning, the knowledge surrounding epilepsy and its comorbidities was systematically extracted from the literature using manual relation extraction and encoded in Biological Expression Language (BEL; 27).

First, a corpus was generated from the 192 245 documents related to epilepsy retrieved (Table 1) to further investigate the causal relations surrounding the identified genes. A second corpus was generated from the 2666 documents retrieved by querying SCAIView for 'epilepsy' and its sub-terms in the Epilepsy Ontology (28) occurring with the free text, 'comorbidity'. Manual relation extraction and encoding in BEL was then performed starting with a select subset of the two corpora based on their prioritization by SCAIView to generate the Epilepsy Knowledge Assembly. The knowledge assembly was further enriched

Table 1. Results of the Epilepsy comorbidity analysis using SCAIView

Disease (MeSH ID)	Associated documents	Disease associated genes	Comorbidity associated genes	Epilepsy pleiotropy rate (%)
Epilepsy (D004827)	192 245	2901	—	—
Stroke (D020521)	210 846	4533	633	17.78
AD (D000544)	109 495	4968	396	13.65
Migraine (D008881)	30 928	1230	306	10.54
PD (D010300)	79 103	3646	258	8.89
Hypertension (D006973)	391 190	5574	252	8.68
Dementia (D003704)	183 802	5833	220	7.58
Diabetes mellitus (D003920)	394 411	6661	184	6.34
Intestinal diseases (D007410)	629 691	9093	166	5.72
Thyroid diseases (D013959)	153 025	4366	133	4.58
Anxiety (D001007)	84 138	1782	124	4.27
Arthritis (D001168)	259 327	5367	122	4.2
Cataract (D002386)	52 150	2238	119	4.1
Asthma (D001249)	147 697	3761	86	2.96
Glaucoma (D005901)	56 679	2303	48	1.65
Depressive disorder, major (D003865)	15 706	1249	46	1.58
Urinary incontinence (D014549)	34 170	720	24	0.82
Peptic ulcer (D010437)	68 234	1445	21	0.72
Back pain (D001416)	48 516	1191	17	0.58
Pulmonary disease, chronic obstructive (D029424)	35 627	2244	15	0.51
Fibromyalgia (D005356)	9021	468	10	0.34
Emphysema (D004646)	25 511	1261	9	0.31
Bronchitis, chronic (D029481)	9085	580	2	0.06

Notes: The number of *associated documents* (column 2) retrieved from SCAIView for each disease is shown given a reference query using corresponding the MeSH term from column 1. The *disease-associated genes* (column 3) contain the number of genes relevant to the corpus retrieved from a disease-specific query. The *comorbidity-associated genes* (column 4) contain the number of genes relevant to the comorbidity query between the target disease and epilepsy. Lastly, the *epilepsy pleiotropy rate* (column 5) describes the ratio of the count of genes reported in column 4 with the total number of epilepsy-associated genes (2901).

with pharmacological knowledge surrounding 19 anti-epileptic drugs and their targets from the Pharmacogenetics and Pharmacogenomics Knowledge Base (PharmGKB; 29). Ultimately, the knowledge assembly comprised relations from 641 unique citations. Finally, the PyBEL framework (30) was used to parse and validate the syntax and semantics of the underlying BEL Script. A summary of the contents of the Epilepsy Knowledge Assembly is presented in Table 2.

Preparation for mechanism enrichment

The Epilepsy Knowledge Assembly was enriched with mechanistic annotations following the procedures outlined by Domingo-Fernández *et al.* (24) in order to integrate it into NeuroMMSig and enable multi-modal mechanism enrichment analyses with queries over genes, SNPs and neuroimaging features.

A taxonomy of epilepsy mechanisms was generated by combining the list of well-established epilepsy mechanisms from Staley (31) with concepts from the Pathway Terminology System (32) co-occurring in articles matching either [MeSH Disease: ‘Epilepsy’] or entries in the Epilepsy

Ontology indexed by SCAIView. The resulting 784 terms representing mechanisms were curated in order to normalize entities, remove irrelevant entries and group similar terms. Next, relations in the Epilepsy Knowledge Assembly were annotated with mechanisms based on whether their entities were involved in the mechanism as outlined by Domingo-Fernández *et al.* (24). During the annotation process, new mechanisms not yet included in the inventory were found in the literature; thus, the mechanism inventory was updated in parallel until concluding the annotation with a total of 32 annotated sub-graphs (Table 2). More details and examples about the mapping procedure can be found on the NeuroMMSig introduction page.

In the next section, NeuroMMSig is used to identify shared mechanisms between epilepsy and AD on the basis of the mechanism of action of multi-indication drugs.

Results and discussions

Investigation of comorbidities

Of the 2901 genes identified as associated with epilepsy by having a positive relative entropy score, Table 1 shows

Table 2. Statistics over the Epilepsy Knowledge Assembly generated by PyBEL, grouped by sub-graph

Sub-graph name	Biological entities	Relationships	Connected Components	Citations
Adaptive immune system sub-graph	12	12	4	5
Adenosine signaling sub-graph	76	154	3	15
Apoptosis signaling sub-graph	228	503	5	115
Brain-derived neurotrophic factor signaling sub-graph	75	142	1	29
Calcium dependent sub-graph	302	793	8	73
Chromatin organization sub-graph	8	10	2	2
Energy metabolic sub-graph	91	177	4	24
Estradiol metabolism	7	8	2	1
G-protein-mediated signaling	78	140	5	25
Gaba sub-graph	262	632	2	56
Glutamatergic sub-graph	121	246	5	32
Hormone signaling sub-graph	126	256	9	16
Inflammatory response sub-graph	42	49	4	21
Innate immune system sub-graph	41	63	8	18
Interleukin signaling sub-graph	46	111	3	17
Long term synaptic depression	64	129	2	21
Long term synaptic potentiation	125	252	2	46
Mapk-erk sub-graph	313	706	5	68
Metabolism	340	600	14	126
Mirna sub-graph	5	4	1	3
Mossy fiber sub-graph	38	66	2	14
Mtor signaling sub-graph	166	336	3	42
Neurotransmitter release sub-graph	552	1667	5	131
Notch signaling sub-graph	105	205	3	20
Protein kinase signaling sub-graph	377	850	6	87
Protein metabolism	129	185	8	44
Reelin signaling sub-graph	117	253	2	21
Regulation of actin cytoskeleton sub-graph	5	3	2	2
Serotonergic sub-graph	148	478	2	18
Thyroid hormone signaling sub-graph	106	228	2	9
Transport related sub-graph	49	60	7	25
Wnt signaling sub-graph	27	38	3	15
<i>Total</i>	<i>3478</i>	<i>12481</i>	<i>16</i>	<i>641</i>

Notes: The first column, *biological entities*, corresponds to the number of genes, chemicals, proteins, biological process, etc. in each sub-graph. The second column, *relationships* (i.e. edges), corresponds to the number of connections between each sub-graphs' biological entities. The third column, *connected components*, corresponds to the number of 'connected' groups of nodes within each sub-graph. The final column, *citations*, corresponds to the total number of articles from which information was extracted to build each sub-graph. A more detailed summary is included in the [Supplementary Material](#).

that nervous system conditions were among the highest literature-based gene overlap (10.54% of epilepsy genes co-occurred with migraine, 7.58% with dementia, 8.89% with PD and 13.65% with AD). While these conditions were also highly ranked in epidemiological studies by their prevalence ratios, literature-based gene overlap does not correlate with prevalence ratios across all of the conditions reported by Keezer *et al.* ([Supplementary Figure S2](#)) and therefore is the best tool for gaining insight into the comorbidities of epilepsy.

While literature-based methods may be a poor proxy for genetic pleiotropy and are generally insufficient for unraveling the shared pathophysiology in epilepsy and studied

comorbidities, systematic approaches for identifying and evaluating shared mechanisms may better explain the aggregate effects of their interactions that cannot be captured by simple approaches like literature co-occurrence.

Mechanism enrichment

AD was chosen as a putative comorbidity of epilepsy for further investigation not only because it had the highest literature-based gene overlap with epilepsy ([Table 1](#)), but additionally because of the prior existence of the AD Knowledge Assembly ([33](#)) and its inclusion in NeuroMMSig.

Of the most frequently mentioned drugs in epilepsy literature ([Supplementary Figure S1](#)), we identified carbamazepine as having both notable target representation in the AD Knowledge Assembly along with multiple references indicating its positive effects on memory and treatment of elderly patients with seizures (34) as well as positive effects in the treatment of AD patients (34, 35).

In the following sections, NeuroMMSig is first used to investigate the mechanisms enriched by the targets of carbamazepine in the context of epilepsy. After, a comparative enrichment is made to identify possible overlapping mechanisms with AD in order to explore the therapeutic effects of the drug in both disease contexts.

Epilepsy mechanism enrichment

While carbamazepine has been observed to act through inhibition of sodium and calcium voltage-gated channels as well as activation of the GABA receptors (36, 37), its mechanism of action is still not fully understood (38). In order to better understand the impact of the drug, the gene set of all of its known targets ([Supplementary Text S1](#)), was queried on the NeuroMMSig mechanism enrichment server against the Epilepsy Knowledge Assembly.

Because the NeuroMMSig mechanism enrichment algorithm only provides relative scores, the top 10th percentile of results were used. Of the 12 networks with at least one mapped gene, those with an enrichment score in the top 10th percentile (above 0.696) were the adenosine signaling sub-graph and the GABA sub-graph ([Supplementary Table S1](#)). While the increase of the purine nucleoside, adenosine, has been associated with the incidence of seizures, its mechanistic connection is still unknown (39). However, recent research has identified several promising targets that regulate and balance adenosine levels such as adenosine kinase (ADK) and its receptors (ADORA family; 39, 40). Similarly to adenosine, the inhibitory neurotransmitter response induced by GABA is responsible for balancing many excitatory signals occurring in the brain. Studies that investigated reduction and abnormalities in GABA-inhibitory processes lead to the development of GABA agonists (e.g. vigabatrin and tiagabine) that act as anti-convulsants in epilepsy patients (41).

After assessing the plausibility of these sub-graphs' involvement in the aetiology of epilepsy, the union of the networks was used to further investigate the relation between the downstream effects of carbamazepine and its therapeutic effect on epilepsy patients. Due to its size, it was necessary to filter and query the network by finding the shortest paths between the drug's targets and different biological processes of interest in the context of epilepsy then

combining them to form a new graph to support quickly identifying candidate pathways. Finally, the common upstream controllers between each pathway were included to provide further context to their overlap. Combining, reasoning over, and manually interpreting the generated paths lead to the simplified network depicted in [Figure 2](#) representing the downstream effects of carbamazepine.

The figure demonstrates the synergistic effects of the activation of the GABA receptor family and the inhibition of the sodium voltage-gated channels to potentiate GABA-mediated inhibition, and therefore, decrease the risk of developing seizures. Furthermore, carbamazepine causes an increase in the production of adenosine, whose receptors, ADORA1 and ADORA3, in a positive feedback loop with the production of adenosine which ultimately leads to a reduction in glutamatergic excitatory signals. Synaptic plasticity in response to the downstream effects of these signals may contribute to drug resistance, and ultimately, seizure recurrence.

Comparative mechanism enrichment

NeuroMMSig was queried with the same gene set in the context of AD in order to perform a comparative investigation of shared mechanistic perturbations with epilepsy. Because the mechanism of action of carbamazepine is poorly represented in the literature ([Supplementary Table S2](#)) and its known targets are less implicated in AD, it was unsurprising that fewer sub-graphs were enriched in the context of AD.

The most significant, the GABA sub-graph, which describes the upstream controllers of the GABA receptor and its downstream effectors, highly overlapped with the GABA sub-graph in the context of the epilepsy—it contains key relations that may explain the efficacy of carbamazepine in both conditions. Studies in AD models have shown a negative correlation between the abundance of amyloid beta 42 and the expression of the transcription factor for the GABA receptor family EGR1 (42, 43). This correlation could be caused by an unknown controller in the aetiology of AD; in which state, a patient would have decreased expression of EGR1 and therefore fewer GABA receptors and less ability to inhibit the excitatory signals that lead to seizures. While the link between epilepsy and GABAergic neurotransmission has already been exploited by anti-epileptic drugs, its role in AD is not yet clearly understood ([Figure 2](#)). However, several recent publications have rationalized targeting GABAergic neurotransmission for treatment of AD (44, 45).

Tangentially, EGR1 upregulates the expression of PSEN2, a member of the catalytic sub-unit of the γ -secretase complex that regulates APP cleavage (46). Mutations

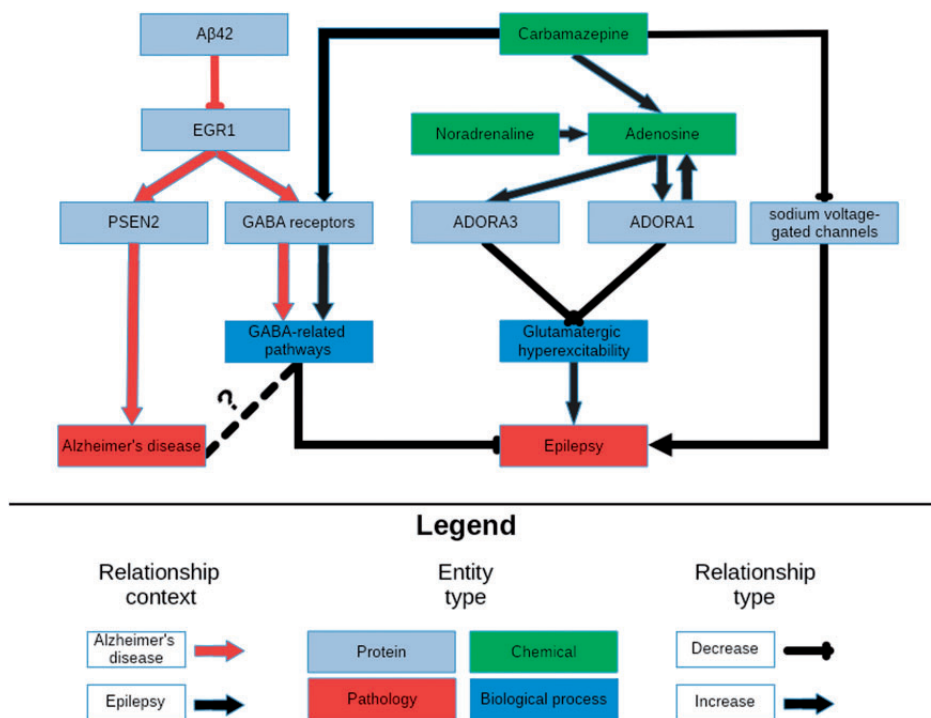

Figure 2. A schematic representation of the knowledge surrounding carbamazepine retrieved by querying its targets with NeuroMMSig. The relevant portions of the most significantly enriched graphs in the context of epilepsy and AD, the adenosine signaling and the GABA sub-graphs, were merged and displayed in order to highlight a potential explanatory mechanism for the therapeutic effects of carbamazepine (Supplementary Text S2). It is rendered with a hierarchical layout to mirror the flow from molecular entities to proteins, biological processes and pathologies.

in PSEN2 that have been both linked to amyloid beta accumulation (47) and seizures in AD patients (48) provide further evidence for the existence for a shared mechanism through which carbamazepine acts in the contexts of AD and epilepsy (Figure 2).

Noradrenaline is a known anti-convulsant (49) that is often lacking in patients in the early stages of AD due to an observed loss of noradrenergic neurons (50). Because carbamazepine has been observed to activate noradrenergic neurons (51), its anti-convulsant activity may be due to it indirectly increasing noradrenaline levels. Finally, noradrenaline potentiates the previously mentioned adenosine pathways (52).

While mechanism enrichment provides several insights, a cursory search of PubMed of ‘Carbamazepine’[nm] AND ‘Alzheimer disease’[MeSH Terms] suggested publications (53) that implicate autophagy in the therapeutic action of Carbamazepine. Further investigation showed Carbamazepine does not have a significant effect on expression of proteins in the mTOR-pathway (53) and that it is likely increasing autophagic flux through an mTOR-independent pathway. Mechanism enrichment analysis was unable to prioritize autophagy pathways due to some

of the shortcomings of knowledge-based methods. For example, the AD NeuroMMSig sub-graph corresponding to autophagy pathways did not contain any of the targets of Carbamazepine listed by PharmGKB. This could be due to the choice of boundaries in sub-graph definition, or also due to the lack of annotation of autophagy-related targets in PharmGKB. Autophagy has been implicated in epilepsy, but the literature has not yet succinctly described the connection from the therapeutic to its target, pathway, and finally the pathology. Finally, because knowledge assemblies are inherently incomplete, this shows the complementary nature of the two approaches.

While the exact mechanism of action of carbamazepine remains elusive, this proposed mechanism enrichment approach was able to identify multiple pathways through which it could be acting in both the AD, epilepsy and shared context. Looking forward, this approach can be applied across a wide variety of chemical matter in the neurodegenerative disease space, as well as in other domains for which appropriately annotated knowledge assemblies exist, in order to support identification of drugs’ mechanisms of actions, drug repositioning opportunities and the development of new lead compounds.

Conclusion

Our findings indicate that literature-based methods as a proxy for genetic pleiotropy generally do not correlate with the results from epidemiological studies of epilepsy and its comorbidities. Furthermore, strictly gene-centric methods lack the ability to elucidate mechanistic insight that a knowledge assembly can support.

After formalizing a representative sample of the knowledge surrounding epilepsy, its risk factors, its comorbidities and anti-epileptic drugs, we annotated mechanistic subgraphs to include in the NeuroMMSig mechanism enrichment server. Finally, an enrichment approach focusing on the targets of carbamazepine proposed the several downstream effectors (including the GABA receptor, GABAergic pathways, etc.) that could explain its therapeutic effects in both the contexts of epilepsy and AD.

Future work will include applying this procedure to a wider variety of drugs and chemical matter across different diseases. Finally, we have made the Epilepsy Knowledge Assembly publicly available through NeuroMMSig (<http://neurommsig.scai.fraunhofer.de>) to facilitate further systems biology and chemoinformatics investigations of epilepsy.

Supplementary data

Supplementary data are available at *Database* Online.

Acknowledgement

The authors would like to thank our colleagues at Fraunhofer SCAI for their critical review of this manuscript.

Funding

This work was supported by the European Union/European Federation of Pharmaceutical Industries and Associations (EFPIA) Innovative Medicines Initiative Joint Undertaking under AETIONOMY [Joint Technology Initiatives grant number 115568], resources of which are composed of financial contribution from the European Union's Seventh Framework Programme (FP7/2007-2013) and EFPIA companies in kind contribution.

Conflict of interest. None declared.

References

- Baillieux, H., Verslegers, W., Paquier, P. *et al.* (2008) Cerebellar cognitive affective syndrome associated with topiramate. *Clin. Neurol. Neurosurg.*, **110**, 496–499.
- Fisher, R.S., Acevedo, C., Arzimanoglou, A. *et al.* (2014) ILAE official report: a practical clinical definition of epilepsy. *Epilepsia*, **55**, 475–482.
- Télez-Zenteno, J.F., Matijevic, S. and Wiebe, S. (2005) Somatic comorbidity of epilepsy in the general population in Canada. *Epilepsia*, **46**, 1955–1962.
- Sander, J.W. (2013) Comorbidity and premature mortality in epilepsy. *Lancet*, **382**, 1618–1619.
- Selassie, A.W., Wilson, D.A., Martz, G.U. *et al.* (2014) Epilepsy beyond seizure: a population-based study of comorbidities. *Epilepsy Res.*, **108**, 305–315.
- Seidenberg, M., Pulsipher, D.T. and Hermann, B. (2009) Association of epilepsy and comorbid conditions. *Future Neurol.*, **4**, 663–668.
- Toldo, I., Perissinotto, E., Menegazzo, F. *et al.* (2010) Comorbidity between headache and epilepsy in a pediatric headache center. *J. Headache Pain*, **11**, 235–240.
- Winawer, M.R. and Connors, R. (2013) Evidence for a shared genetic susceptibility to migraine and epilepsy. *Epilepsia*, **54**, 288–295.
- Rogawski, M.A. (2012) Migraine and epilepsy—shared mechanisms within the family of episodic disorders. In: Noebels, J.L., Avoli, M., Rogawski, M.A. *et al.* (eds). *Jasper's Basic Mechanisms of Epilepsies*, 4th edn. National Center for Biotechnology Information, Bethesda, MD, pp. 930–944.
- Storey, J.R., Calder, C.S., Hart, D.E. *et al.* (2001) Topiramate in migraine prevention: a double-blind, placebo-controlled study. *Headache*, **41**, 968–975.
- Rothrock, J.F. (2012) Topiramate for migraine prevention: an update. *Headache*, **52**, 859–860.
- Miranda, D.D.C. and Brucki, S.M.D. (2014) Epilepsy in patients with Alzheimer's disease: a systematic review. *Dement Neuropsychol.*, **8**, 66–71.
- Amatniek, J.C., Hauser, W.A., DelCastillo-Castaneda, C. *et al.* (2006) Incidence and predictors of seizures in patients with Alzheimer's disease. *Epilepsia*, **47**, 867–872.
- Larner, A.J. and Doran, M. (2006) Clinical phenotypic heterogeneity of Alzheimer's disease associated with mutations of the presenilin-1 gene. *J. Neurol.*, **253**, 139–158.
- Jayadev, S., Leverenz, J.B., Steinbart, E. *et al.* (2010) Alzheimer's disease phenotypes and genotypes associated with mutations in presenilin 2. *Brain*, **133**, 1143–1154.
- Cabrejo, L., Guyant-Maréchal, L., Laquerrière, A. *et al.* (2006) Phenotype associated with APP duplication in ve families. *Brain*, **129**, 2966–2976.
- Lv, R.J., He, J.S., Fu, Y.H. *et al.* (2011) A polymorphism in CALHM1 is associated with temporal lobe epilepsy. *Epilepsy Behav.*, **20**, 681–685.
- Palop, J.J. and Mucke, L. (2009) Epilepsy and cognitive impairments in Alzheimer disease. *Arch. Neurol.*, **66**, 435–440.
- Jansen, F.E., Vincken, K.L., Algra, A. *et al.* (2008) Cognitive impairment in tuberous sclerosis complex is a multifactorial condition. *Neurology*, **70**, 916–923.
- Osborne, J.P., Lux, A.L., Edwards, S.W. *et al.* (2010) The underlying etiology of infantile spasms (West syndrome): information from the United Kingdom Infantile Spasms Study (UKISS) on contemporary causes and their classification. *Epilepsia*, **51**, 2168–2174.
- Thompson, P.J., Baxendale, S.A., Duncan, J.S. *et al.* (2000) Effects of topiramate on cognitive function. *J. Neurol. Neurosurg. Psychiatry*, **69**, 636–641.

22. Lee,S.H., Yang,J., Goddard,M.E. *et al.* (2012) Estimation of pleiotropy between complex diseases using single-nucleotide polymorphism-derived genomic relationships and restricted maximum likelihood. *Bioinformatics*, **28**, 2540–2542.
23. Keezer,M.R., Sisodiya,S.M. and Sander,J.W. (2016) Comorbidities of epilepsy: current concepts and future perspectives. *Lancet Neurol.*, **15**, 106–115.
24. Domingo-Fernández,D., Kodamullil,A.T., Iyappan,A. *et al.* (2017) Multimodal mechanistic signatures for neurodegenerative diseases (NeuroMMSig): a web server for mechanism enrichment. *Bioinformatics*, **33**, 3679–3681.
25. Younesi,E., Toldo,L., Müller,B. *et al.* (2012) Mining biomarker information in biomedical literature. *BMC Med. Inf. Decision Making*, **12**, 148.
26. Bellazzi,R. (2014) Big data and biomedical informatics: a challenging opportunity. *Yearbook Med. Inf.*, **9**, 8.
27. Slater,T. (2014) Recent advances in modeling languages for pathway maps and computable biological networks. *Drug Discov. Today*, **19**, 193–198.
28. Almeida,P., Gomes,P., Sales,F. *et al.* (2010) Ontology and knowledge management system on epilepsy and epileptic seizures. *Eprint arXiv*, 1012.1638.
29. Whirl-Carrillo,M., McDonagh,E.M., Hebert,J.M. *et al.* (2012) Pharmacogenomics knowledge for personalized medicine. *Clin. Pharmacol. Therapeutics*, **92**, 414–417.
30. Hoyt,C.T., Konotopez,A. and Ebeling,C. (2017) PyBEL: a computational framework for Biological Expression Language. *Bioinformatics*, btx660.
31. Staley,K. (2015) Molecular mechanisms of epilepsy. *Nat. Neurosci.*, **18**, 367–372.
32. Iyappan,A., Gündel,M., Shahid,M. *et al.* (2016) Towards a pathway inventory of the human brain for modeling disease mechanisms underlying neurodegeneration. *J. Alzheimer's Dis.*, **52**, 1343–1360.
33. Kodamullil,T.A., Younesi,E., Naz,M. *et al.* (2015) Computable cause-and-effect models of healthy and Alzheimer's disease states and their mechanistic differential analysis. *Alzheimer's & Dementia: J. Alzheimer's Assoc.*, **11**, 1329–1339.
34. Li,L., Zhang,S., Zhang,X. *et al.* (2013) Autophagy enhancer carbamazepine alleviates memory deficits and cerebral amyloid- β pathology in a mouse model of Alzheimer's disease. *Curr. Alzheimer Res.*, **10**, 433–441.
35. Tariot,P.N., Erb,R., Podgorski,C.A. *et al.* (1998) Efficacy and tolerability of carbamazepine for agitation and aggression in dementia. *Am. J. Psychiatry*, **155**, 54–61.
36. Granger,P., Biton,B., Faure,C. *et al.* (1995) Modulation of the gamma-aminobutyric acid type A receptor by the antiepileptic drugs carbamazepine and phenytoin. *Mol. Pharmacol.*, **47**, 1189–1196.
37. Liu,L., Zheng,T., Morris,M.J. *et al.* (2006) The mechanism of carbamazepine aggravation of absence seizures. *J. Pharmacol. Exper. Therapeutics*, **319**, 790–798.
38. Ambrósio,A.F., Soares-da-Silva,P., Carvalho,C.M. *et al.* (2002) Mechanisms of action of carbamazepine and its derivatives, oxcarbazepine, BIA 2-093, and BIA 2-024. *Neurochem. Res.*, **27**, 121–130.
39. Boison,D. (2013) Adenosine and seizure termination: endogenous mechanisms. *Epilepsy Curr.*, **13**, 35–37.
40. Masino,S.A., Kawamura,M. Jr. and Ruskin,D.N. (2014) Adenosine receptors and epilepsy: current evidence and future potential. *Int. Rev. Neurobiol.*, **119**, 233–255.
41. Treiman,D.M. (2001) GABAergic mechanisms in epilepsy. *Epilepsia*, **42 Suppl 3**, 8–12.
42. Murphy,M.P. and LeVine,H. III. (2010) Alzheimer's disease and the amyloid-beta peptide. *J. Alzheimers Dis.*, **19**, 311–323.
43. Mo,J., Kim,C.H., Lee,D. *et al.* (2015) Early growth response 1 (Egr-1) directly regulates GABAA receptor $\alpha 2$, $\alpha 4$, and $\alpha 5$ subunits in the hippocampus. *J. Neurochem.*, **133**, 489–500.
44. Solas,M., Puerta,E. and Ramirez,M.J. (2015) Treatment options in Alzheimer's disease: the GABA story. *Curr. Pharm. Des.*, **21**, 4960–4971.
45. Li,Y., Sun,H., Chen,Z. *et al.* (2016) Implications of GABAergic neurotransmission in Alzheimer's disease. *Front. Aging Neurosci.*, **8**, 31.
46. Renbaum,P., Beeri,R., Gabai,E. *et al.* (2003) Egr-1 upregulates the Alzheimer's disease presenilin-2 gene in neuronal cells. *Gene*, **318**, 113–124.
47. Steiner,H., Capell,A., Leimer,U. *et al.* (1999) Genes and mechanisms involved in β -amyloid generation and Alzheimer's disease. *Eur. Arch. Psychiatry Clin. Neurosci.*, **249**, 266–270.
48. Noebels,J. (2011) A perfect storm: converging paths of epilepsy and Alzheimer's dementia intersect in the hippocampal formation. *Epilepsia*, **52**, 39–46.
49. Giorgi,F.S., Pizzanelli,C., Biagioni,F. *et al.* (2004) The role of norepinephrine in epilepsy: from the bench to the bedside. *Neurosci. Biobehav. Rev.*, **28**, 507–524.
50. Braak,H., Thal,D.R., Ghebremedhin,E. *et al.* (2011) Stages of the pathologic process in Alzheimer disease: age categories from 1 to 100 years. *J. Neuropathol. Exper. Neurol.*, **70**, 960–969.
51. Olpe,H.R. and Jones,R.S. (1983) The action of anticonvulsant drugs on the ring of locus coeruleus neurons: selective, activating effect of carbamazepine. *Eur. J. Pharmacol.*, **91**, 107–110.
52. Pearson,T. and Frenguelli,B.G. (2004) Adrenoceptor subtype-specific acceleration of the hypoxic depression of excitatory synaptic transmission in area CA1 of the rat hippocampus. *Eur. J. Neurosci.*, **20**, 1555–1565.
53. Zhang,L., Wang,L., Wang,R. *et al.* (2017) Evaluating the effectiveness of GTM-1, rapamycin, and carbamazepine on autophagy and Alzheimer disease. *Med. Sci. Monitor: Int. Med. J. Exper. Clin. Res.*, **23**, 801–808.

Postface

The analysis presented in this publication ranked disease-specific mechanisms in AD and epilepsy that are likely targeted by carbamazepine and ultimately lead to the hypothesis that the GABA-ergic receptor pathway was central to its multi-indication effect. Importantly, this investigation was advantageous over black box machine learning models because the underlying knowledge assemblies are self-explanatory and based on publications published in molecular biology and epidemiology. After, the prospects of applying these techniques in a more automated fashion in order to investigate many more drugs and disease combinations were discussed.

In the spirit of reproducible and reusable science, the instructions, scripts, and the Epilepsy Knowledge Assembly have been made publicly available at <https://github.com/neurommsig-epilepsy> in order to enable other scientists to reproduce ours and conduct their own investigations.

Given the automation enabled by the enrichment methods described in Chapters 4 and 5, this analysis can be more heavily automated to provide new insights as the underlying knowledge assemblies grow and increase in granularity. As several new neurodegenerative diseases (e.g., multiple sclerosis, amyotrophic lateral sclerosis, Huntington's disease) are currently being added to NeuroMMSig, new shared mechanisms will become apparent and lead to new hypotheses to be tested in epidemiological studies and later for drug repositioning.

9 Epilogue

9.1 Summary

The work in this thesis can be best summarized in three sections: 1) generation of an ecosystem for BEL, 2) development of methods and tools for enriching biological knowledge graphs, and 3) applications of knowledge graphs in simulation, modeling, and analysis of data.

In Chapter 2, the PyBEL ecosystem was introduced in order to support the parsing, validation, and manipulation of biological knowledge graphs encoded in BEL. It was shown to support the implementation of algorithms and interoperability with other systems and networks biology tools such as NDEx. In Chapter 3, the BEL Commons web application was introduced as a way to make the tools implemented with PyBEL accessible to a wider variety of users who have different skill sets. It was shown to support knowledge-assisted analysis of *-omics* data and provide interactive exploration of biological knowledge graphs.

In Chapter 4, PyBEL was used in two ways to support quality assurance and enrichment of biological knowledge graphs in BEL. First, a re-curation workflow was proposed using version control systems, continuous integration, and a novel extension to PyBEL that can directly interface with git. Second, PyBEL was integrated with INDRA and semi-automated relation extraction workflow was generated that prioritized curation of low information-density areas of a given biological knowledge graph. In Chapter 5, Bio2BEL was introduced as both a philosophy and accompanying framework for reproducibly acquiring and integrating multi-modal and multi-scale knowledge from many sources in BEL. Several applications of the

Bio2BEL framework that have already been published in peer-reviewed journals were presented as examples of the impact and utility of Bio2BEL.

In Chapter 6, the first of the three applications of highly enriched biological knowledge graphs was presented. In it, BEL2ABM was shown to be able to convert static biological knowledge graphs into dynamic, executable agent-based models that could recapitulate ordinary differential equation models of biological systems after undergoing parameter optimization. In Chapter 7, GuiltyTargets was introduced as an alternative to topological feature engineering that, when applied in the target prioritization task, outperformed the previous state of the art. These results implied that NRL on biological knowledge graphs has huge potential in not only target prioritization, but potentially any tasks that rely on feature engineering from knowledge graphs. In Chapter 8, the final application was presented about using biological knowledge graphs annotated with disease specificity to not only deconvolute the mechanism of action of the drug, carbamazepine, but to hypothesize an explanation for its epidemiologically observed multi-indication effects in AD and epilepsy.

9.2 Future Work

While this thesis only represents work that has been finalized and written as full manuscripts, it has led to a significant amount of ongoing work. I expect that the PyBEL ecosystem and BEL Commons will evolve to suit new algorithms and new needs from the community. They will also grow to support interchange between new formats such as the GO-CAM and the BEL-like language used by neXtProt [149]. Maintaining software is not often considered by academics, but much care has been taken to ensure this is possible. As Bio2BEL is extensible and demonstrably facile for external developers, I also expect it to grow along with the generation and publication of new and exciting biological data sources. More specifically, the PyBEL and BEL Commons codebase will be incorporated into the next release of the NeuroMMSig Mechanism Enrichment Server from [131]. It will also include features from Bio2BEL to more dynamically link to other resources, as well as directly querying compounds as a fourth modality in addition to genes, mutations, and clinical features.

The most interesting future work lies with the generation of new analytical techniques using NRL to solve similar and new problems relevant to drug discovery. Following the completion of Özlem Muslu's master's thesis, which was the

basis for *GuiltyTargets*, four new master's theses have commenced concerning 1) the incorporation of phenome-wide association studies, 2) the application of NRL to the drug repositioning workflow presented by Himmelstein *et al.* [148], 3) the benchmarking of NRL in multi-modal graphs for deconvolution of mechanism of actions causing side effects, and 4) alternate ways to include disease-specific signatures in underlying networks before representation learning and application of target prioritization. While the publication from Chapter 8 focused on a single drug in the context of two diseases, the methods can be more generally applied across all drugs listed in DrugBank [150] and all diseases covered by NeuroMMSig to identify further repositioning candidates. Further, this could lead to an interesting exploration of chemical space and the scaffolds that occur in multi-indication drugs.

In order to support the inclusion of new neurodegenerative diseases in NeuroMMSig like Huntington's disease and multiple sclerosis, several additions can be made to the rational enrichment pipeline presented in Chapter 4. First, it can be presented as a web interface and more tightly integrated with the visualization tools included in BEL Commons. Second, NRL can also be used to automatically assign BEL statements to sub-graphs in NeuroMMSig using a combination of the inter-database pathway mappings included in ComPath [137] and the BioKEEN [107] software.

9.3 Impact, Reflections, and Acknowledgements

As most of the preface and postfaces above stated, the work presented here has not been done in a vacuum. I have built each component of the PyBEL ecosystem on the previous to support each story in this thesis. In the end, the code that was originally developed in 2016 became an entire platform for systems and networks biology that vastly transcended its original goal of being a new and stable compiler for BEL.

While I have mostly used the passive voice throughout this thesis to describe the work that has been done, it would be blasphemous to finish without crediting all of the wonderful scientists with whom I've written each of the included publications. The work I have done during the course of my doctorate has not been done in isolation: it has been used and improved by several members my group at the Fraunhofer SCAI Department of Bioinformatics throughout their own master's and doctoral theses. Each of them has left their own footprints throughout.

Conversely, I've also had the pleasure to incorporate the work of others into mine: unabashedly and without worry of jealousy or conflict.

The work presented here has also provided support to the partners in our projects and to the wider community. As I reflect on what I have done in my doctorate, I believe that the openness with which I have done my work has led to some of my most interesting work and some of the most interesting collaborations: many of which I have not included here (but if you're interested, that work won't be hard to find, either). I find it exciting to consider that as this thesis comes to a close that my work may continue, even without me.

Bibliography

- [1] Bethan Yates et al. " Genenames.org: The HGNC and VGNC resources in 2017 ". In: *Nucleic Acids Res.* 45.D1 (2017), pp. D619–D625.
- [2] Donna Maglott, Jim Ostell, Kim D. Pruitt, and Tatiana Tatusova. " Entrez gene: Gene-centered information at NCBI ". In: *Nucleic Acids Res.* 39.SUPPL. 1 (2011), pp. 52–57.
- [3] Judith A. Blake et al. " Mouse Genome Database (MGD)-2017: Community knowledge resource for the laboratory mouse ". In: *Nucleic Acids Res.* 45.D1 (2017), pp. D723–D729.
- [4] Mary Shimoyama et al. " The Rat Genome Database 2015: Genomic, phenotypic and environmental variations and disease ". In: *Nucleic Acids Res.* 43.D1 (2015), pp. D743–D750.
- [5] Daniel R Zerbino et al. " Ensembl 2018. " In: *Nucleic Acids Res.* 46.D1 (Jan. 2018), pp. D754–D761.
- [6] Mathew W Wright, Tina A Eyre, Michael J Lush, Sue Povey, and Elspeth A Bruford. " HCOP: the HGNC comparison of orthology predictions search tool. " In: *Mamm. Genome* 16.11 (Nov. 2005), pp. 827–8.
- [7] Douglas G Howe et al. " ZFIN, the Zebrafish Model Organism Database: increased support for mutants and transgenics. " In: *Nucleic acids research* 41.Database issue (Jan. 2013), pp. D854–60.
- [8] Jim Thurmond et al. " FlyBase 2.0: the next generation. " In: *Nucleic acids research* 47.D1 (Jan. 2019), pp. D759–D765.
- [9] Kamran Karimi et al. " Xenbase: a genomic, epigenomic and transcriptomic model organism database ". In: *Nucleic Acids Research* 46.D1 (Jan. 2018), pp. D861–D868.

- [10] J Michael Cherry et al. " Saccharomyces Genome Database: the genomics resource of budding yeast. " In: *Nucleic acids research* 40.Database issue (Jan. 2012), pp. D700–5.
- [11] John A. Bachman, Benjamin M. Gyori, and Peter K. Sorger. " FamPlex: A resource for entity recognition and relationship resolution of human protein families and complexes in biomedical text mining ". In: *BMC Bioinformatics* 19.1 (2018), pp. 1–14.
- [12] Jerry R Hobbs. " Resolving pronoun references ". In: *Lingua* 44.4 (1978), pp. 311–338.
- [13] Susan E. Brennan, Marilyn W. Friedman, and Carl J. Pollard. "A Centering Approach to Pronouns". In: *Proceedings of the 25th Annual Meeting on Association for Computational Linguistics*. ACL '87. Stanford, California: Association for Computational Linguistics, 1987, pp. 155–162.
- [14] Wee Meng Soon, Hwee Tou Ng, and Daniel Chung Yong Lim. "A Machine Learning Approach to Coreference Resolution of Noun Phrases". In: *Comput. Linguist.* 27.4 (Dec. 2001), pp. 521–544.
- [15] Vincent Ng and Claire Cardie. "Identifying Anaphoric and Non-anaphoric Noun Phrases to Improve Coreference Resolution". In: *Proceedings of the 19th International Conference on Computational Linguistics - Volume 1*. COLING '02. Taipei, Taiwan: Association for Computational Linguistics, 2002, pp. 1–7.
- [16] Eric Bengtson and Dan Roth. "Understanding the Value of Features for Coreference Resolution". In: *Proceedings of the Conference on Empirical Methods in Natural Language Processing*. EMNLP '08. Honolulu, Hawaii: Association for Computational Linguistics, 2008, pp. 294–303.
- [17] Xiaoqiang Luo, Abe Ittycheriah, Hongyan Jing, Nanda Kambhatla, and Salim Roukos. "A Mention-synchronous Coreference Resolution Algorithm Based on the Bell Tree". In: *Proceedings of the 42Nd Annual Meeting on Association for Computational Linguistics*. ACL '04. Barcelona, Spain: Association for Computational Linguistics, 2004.

- [18] Xiaofeng Yang, Jian Su, Guodong Zhou, and Chew Lim Tan. “An NP-cluster Based Approach to Coreference Resolution”. In: *Proceedings of the 20th International Conference on Computational Linguistics*. COLING '04. Geneva, Switzerland: Association for Computational Linguistics, 2004.
- [19] Xiaofeng Yang et al. “An Entity-Mention Model for Coreference Resolution with Inductive Logic Programming”. In: *Proceedings of ACL-08: HLT*. Columbus, Ohio: Association for Computational Linguistics, June 2008, pp. 843–851.
- [20] Heeyoung Lee et al. “Stanford’s Multi-pass Sieve Coreference Resolution System at the CoNLL-2011 Shared Task”. In: *Proceedings of the Fifteenth Conference on Computational Natural Language Learning: Shared Task*. CONLL Shared Task '11. Portland, Oregon: Association for Computational Linguistics, 2011, pp. 28–34.
- [21] Pascal Denis and Jason Baldridge. “A Ranking Approach to Pronoun Resolution”. In: *Proceedings of the 20th International Joint Conference on Artificial Intelligence*. IJCAI'07. Hyderabad, India: Morgan Kaufmann Publishers Inc., 2007, pp. 1588–1593.
- [22] Altaf Rahman and Vincent Ng. “Supervised Models for Coreference Resolution”. In: *Proceedings of the 2009 Conference on Empirical Methods in Natural Language Processing: Volume 2 - Volume 2*. EMNLP '09. Singapore: Association for Computational Linguistics, 2009, pp. 968–977.
- [23] Sebastian Martschat and Michael Strube. “Latent Structures for Coreference Resolution”. In: *Transactions of the Association for Computational Linguistics* 3 (2015), pp. 405–418.
- [24] Altaf Rahman and Vincent Ng. “Narrowing the Modeling Gap: A Cluster-ranking Approach to Coreference Resolution”. In: *J. Artif. Int. Res.* 40.1 (Jan. 2011), pp. 469–521.
- [25] Chao Ma et al. “Prune-and-Score: Learning for Greedy Coreference Resolution”. In: *Proceedings of the 2014 Conference on Empirical Methods in Natural Language Processing (EMNLP)*. Stroudsburg, PA, USA: Association for Computational Linguistics, 2014, pp. 2115–2126.

- [26] Kevin Clark and Christopher D. Manning. "Improving Coreference Resolution by Learning Entity-Level Distributed Representations". In: *Proceedings of the 54th Annual Meeting of the Association for Computational Linguistics (Volume 1: Long Papers)*. Berlin, Germany: Association for Computational Linguistics, Aug. 2016, pp. 643–653.
- [27] Chen Li, Zhiqiang Rao, Qinghua Zheng, and Xiangrong Zhang. "A set of domain rules and a deep network for protein coreference resolution". In: *Database 2018* (July 2018). eprint: <http://oup.prod.sis.lan/database/article-pdf/doi/10.1093/database/bay065/27438328/bay065.pdf>.
- [28] John Giorgi and Gary Bader. "Towards reliable named entity recognition in the biomedical domain". In: *bioRxiv* (2019). eprint: <https://www.biorxiv.org/content/early/2019/01/22/526244.full.pdf>.
- [29] Chun-Nan Hsu et al. "Integrating high dimensional bi-directional parsing models for gene mention tagging." In: *Bioinformatics (Oxford, England)* 24.13 (July 2008), pp. i286–94.
- [30] Robert Leaman and Graciela Gonzalez. "BANNER: an executable survey of advances in biomedical named entity recognition." In: *Pacific Symposium on Biocomputing. Pacific Symposium on Biocomputing* (2008), pp. 652–63.
- [31] Jörg Hakenberg et al. "The GNAT library for local and remote gene mention normalization." In: *Bioinformatics (Oxford, England)* 27.19 (Oct. 2011), pp. 2769–71.
- [32] Chih-Hsuan Wei, Hung-Yu Kao, and Zhiyong Lu. "GNormPlus: An Integrative Approach for Tagging Genes, Gene Families, and Protein Domains." In: *BioMed research international* 2015 (2015), p. 918710.
- [33] Robert Leaman, Chih-Hsuan Wei, and Zhiyong Lu. "tmChem: a high performance approach for chemical named entity recognition and normalization." In: *Journal of cheminformatics* 7.Suppl 1 Text mining for chemistry and the CHEMDNER track (2015), S3.
- [34] Peter Corbett and John Boyle. "Chemlistem: chemical named entity recognition using recurrent neural networks". In: *Journal of Cheminformatics* 10.1 (Dec. 2018), p. 59.

- [35] Robert Leaman, Rezarta Islamaj Dogan, and Zhiyong Lu. “ DNorm: disease name normalization with pairwise learning to rank. ” In: *Bioinformatics (Oxford, England)* 29.22 (Nov. 2013), pp. 2909–17.
- [36] Martin Gerner, Goran Nenadic, and Casey M. Bergman. “ LINNAEUS: A species name identification system for biomedical literature ”. In: *BMC Bioinformatics* 11 (2010).
- [37] Chih Hsuan Wei, Hung Yu Kao, and Zhiyong Lu. “ SR4GN: A species recognition software tool for gene normalization ”. In: *PLoS ONE* 7.6 (2012), pp. 7–11.
- [38] Hsin-Chun Lee, Yi-Yu Hsu, and Hung-Yu Kao. “ An enhanced CRF-based system for disease name entity recognition and normalization on BioCreative V DNER Task ”. In: *Proceedings of the Fifth BioCreative Challenge Evaluation Workshop* (2015), pp. 226–233.
- [39] Allan Peter Davis, Thomas C. Wieggers, Michael C. Rosenstein, and Carolyn J. Mattingly. “ MEDIC: A practical disease vocabulary used at the comparative toxicogenomics database ”. In: *Database* 2012 (2012), pp. 1–9.
- [40] Cheng Ju Kuo, Maurice H.T. Ling, Kuan Ting Lin, and Chun Nan Hsu. “ BIOADI: A machine learning approach to identifying abbreviations and definitions in biological literature ”. In: *BMC Bioinformatics* 10.SUPPL. 15 (2009), pp. 1–10.
- [41] Tomas Mikolov, Greg Corrado, Kai Chen, and Jeffrey Dean. “ Efficient Estimation of Word Representations in Vector Space ”. In: (2013), pp. 1–12. arXiv: 1301.3781v3.
- [42] Jeffrey Pennington, Richard Socher, and Christopher D. Manning. “ Glove: Global vectors for word representation ”. In: *In EMNLP* (2014).
- [43] Guillaume Lample, Miguel Ballesteros, Sandeep Subramanian, Kazuya Kawakami, and Chris Dyer. “ Neural Architectures for Named Entity Recognition ”. In: (2016), pp. 260–270. arXiv: 1603.01360.
- [44] J. D. Kim, T. Ohta, Y. Tateisi, and J. Tsujii. “ GENIA corpus - A semantically annotated corpus for bio-textmining ”. In: *Bioinformatics* 19.SUPPL. 1 (2003), pp. 180–182.

- [45] RG Cote, P Jones, R Apweiler, and H Hermjakob. "The Ontology Lookup Service, a lightweight cross-platform tool for controlled vocabulary queries." In: *BMC Bioinformatics* 7 (2006), pp. 1–7.
- [46] *What is the Half-Life of a HGNC Gene Symbol?* https://github.com/bio2bel/bio2bel-notebooks/blob/master/gene_symbol_half_life.ipynb. Accessed: 2019-08-12.
- [47] Camille Laibe and Nicolas Le Novère. "MIRIAM Resources: tools to generate and resolve robust cross-references in Systems Biology." In: *BMC systems biology* 1 (Dec. 2007), p. 58.
- [48] Chris F Taylor et al. "Promoting coherent minimum reporting guidelines for biological and biomedical investigations: the MIBBI project." In: *Nature biotechnology* 26.8 (Aug. 2008), pp. 889–96.
- [49] A Marchetti and F Ronzano. "Formalizing Knowledge by Ontologies: OWL and KIF". In: *Relatório apresentado L' ...* 003 (2008).
- [50] Charles Tapley Hoyt. *Levels of Knowledge Abstraction in Systems Biology*. Aug. 2019.
- [51] Dave Beckett. *RDF/XML Syntax Specification*. 2014.
- [52] M Ashburner, C J Mungall, and S E Lewis. "Ontologies for biologists: a community model for the annotation of genomic data." In: *Cold Spring Harbor symposia on quantitative biology* 68 (2003), pp. 227–35.
- [53] Barry Smith et al. "The OBO Foundry: coordinated evolution of ontologies to support biomedical data integration". In: *Nat Biotech* 25.11 (Nov. 2007), pp. 1251–1255.
- [54] Sirarat Sarntivijai et al. "CLO: The cell line ontology". In: *Journal of Biomedical Semantics* 5.1 (2014), pp. 1–10.
- [55] Emek Demir et al. "The BioPAX community standard for pathway data sharing". In: *Nature Biotechnology* 28.12 (2010), pp. 1308–1308.
- [56] Michael K Gilson et al. "BindingDB in 2015: A public database for medicinal chemistry, computational chemistry and systems pharmacology." In: *Nucleic acids research* 44.D1 (2016), pp. D1045–53.

- [57] Vivian Law et al. " DrugBank 4.0: Shedding new light on drug metabolism ". In: *Nucleic Acids Research* 42.D1 (2014), pp. 1091–1097.
- [58] Sandra Orchard et al. " The MIntAct project - IntAct as a common curation platform for 11 molecular interaction databases ". In: *Nucleic Acids Research* 42.D1 (2014), pp. 358–363.
- [59] Minoru Kanehisa, Miho Furumichi, Mao Tanabe, Yoko Sato, and Kanae Morishima. " KEGG: New perspectives on genomes, pathways, diseases and drugs ". In: *Nucleic Acids Research* 45.D1 (2017), pp. D353–D361. arXiv: 1611.06654.
- [60] Antonio Fabregat et al. " The reactome pathway knowledgebase ". In: *Nucleic Acids Research* 44.D1 (2016), pp. D481–D487.
- [61] Alexander R. Pico et al. " WikiPathways: Pathway Editing for the People ". In: *PLoS Biology* 6.7 (2008), pp. 1403–1407.
- [62] Ethan G. Cerami et al. " Pathway Commons, a web resource for biological pathway data ". In: *Nucleic Acids Research* 39.SUPPL. 1 (2011), pp. 685–690.
- [63] Daniele Merico, Ruth Isserlin, Oliver Stueker, Andrew Emili, and Gary D. Bader. " Enrichment map: A network-based method for gene-set enrichment visualization and interpretation ". In: *PLoS ONE* 5.11 (2010).
- [64] Florence M.G. Cavalli et al. " Intertumoral Heterogeneity within Medulloblastoma Subgroups ". In: *Cancer Cell* 31.6 (2017), 737–754.e6.
- [65] M Hucka et al. " The systems biology markup language (SBML): a medium for representation and exchange of biochemical network models. " eng. In: *Bioinformatics (Oxford, England)* 19.4 (Mar. 2003), pp. 524–531.
- [66] Akira Funahashi, Mineo Morohashi, Hiroaki Kitano, and Naoki Tanimura. "CellDesigner: a process diagram editor for gene-regulatory and biochemical networks". In: *BIOSILICO* 1.5 (2003), pp. 159–162.
- [67] Ted Slater. " Recent advances in modeling languages for pathway maps and computable biological networks ". In: *Drug Discovery Today* 19.2 (Feb. 2014), pp. 193–198.

- [68] René Deehan et al. “ Comparative transcriptional network modeling of three ppar- α / β co-agonists reveals distinct metabolic gene signatures in primary human hepatocytes ”. In: *PLoS ONE* 7.4 (2012).
- [69] Daphna Laifefeld et al. “ Utilization of causal reasoning of hepatic gene expression in rats to identify molecular pathways of idiosyncratic drug-induced liver injury ”. In: *Toxicological Sciences* 137.1 (2014), pp. 234–248.
- [70] Daphna Laifefeld et al. “ Early patient stratification and predictive biomarkers in drug discovery and development: a case study of ulcerative colitis anti-TNF therapy. ” eng. In: *Advances in experimental medicine and biology* 736 (2012), pp. 645–653.
- [71] Natalie L Catlett et al. “ Reverse causal reasoning: applying qualitative causal knowledge to the interpretation of high-throughput data. ” In: *BMC bioinformatics* 14.1 (2013), p. 340.
- [72] Florian Martin et al. “ Quantification of biological network perturbations for mechanistic insight and diagnostics using two-layer causal models ”. In: *BMC Bioinformatics* 15.1 (2014), p. 238.
- [73] Janna Hastings et al. “ The ChEBI reference database and ontology for biologically relevant chemistry: Enhancements for 2013 ”. In: *Nucleic Acids Research* 41.D1 (2013), pp. 456–463.
- [74] F B ROGERS. “ Medical subject headings. ” In: *Bulletin of the Medical Library Association* 51 (Jan. 1963), pp. 114–6.
- [75] Charles Tapley Hoyt. *The Schema of Biological Expression Language*. Jan. 2018.
- [76] Nicolas Le Novère et al. “ The Systems Biology Graphical Notation. ” In: *Nat. Biotechnol.* 27.8 (Aug. 2009), pp. 735–41.
- [77] Daniel Domingo-Fernández, Sarah Mubeen, Josep Marín-Llao, Charles Tapley Hoyt, and Martin Hofmann-Apitius. “ PathMe: merging and exploring mechanistic pathway knowledge ”. In: *BMC Bioinformatics* 20.1 (2019), p. 243.
- [78] Svetlana Novichkova, Sergei Egorov, and Nikolai Daraselia. “ MedScan, a natural language processing engine for MEDLINE abstracts ”. In: *Bioinformatics* 19.13 (2003), pp. 1699–1706.

- [79] Andrey Rzhetsky et al. " GeneWays: A system for extracting, analyzing, visualizing, and integrating molecular pathway data ". In: *J. Biomed. Inform.* 37.1 (2004), pp. 43–53.
- [80] Sumit Madan et al. " The BEL information extraction workflow (BELIEF): Evaluation in the BioCreative V BEL and IAT track ". In: *Database* 2016.September 2017 (2016), pp. 1–17.
- [81] Po Ting Lai, Yu Yan Lo, Ming Siang Huang, Yu Cheng Hsiao, and Richard Tzong Han Tsai. " BelSmile: a biomedical semantic role labeling approach for extracting biological expression language from text ". In: *Database (Oxford)*. 2016.June 2018 (2016), pp. 1–9.
- [82] Majid Rastegar-Mojarad, Ravikumar Komandur Elayavilli, and Hongfang Liu. " BELTracker: evidence sentence retrieval for BEL statements ". In: *Database (Oxford)*. 2016.June (2016), pp. 1–11.
- [83] K. E. Ravikumar, Majid Rastegar-Mojarad, and Hongfang Liu. " BELMiner: Adapting a rule-based relation extraction system to extract biological expression language statements from bio-medical literature evidence sentences ". In: *Database* 2017.1 (2017), pp. 1–12. arXiv: 1611.06654.
- [84] Purvesh Khatri, Marina Sirota, and Atul J. Butte. " Ten years of pathway analysis: Current approaches and outstanding challenges ". In: *PLoS Computational Biology* 8.2 (2012).
- [85] Florian Martin et al. " Assessment of network perturbation amplitudes by applying high-throughput data to causal biological networks. " In: *BMC systems biology* 6 (2012), p. 54.
- [86] Dmitry M Vasilyev, Ty M Thomson, Brian P Frushour, Florian Martin, and Alain Sewer. " An algorithm for score aggregation over causal biological networks based on random walk sampling. " In: *BMC research notes* 7 (2014), p. 516.
- [87] Q. Wang, Z. Mao, B. Wang, and L. Guo. "Knowledge Graph Embedding: A Survey of Approaches and Applications". In: *IEEE Transactions on Knowledge and Data Engineering* 29.12 (Dec. 2017), pp. 2724–2743.

- [88] Antoine Bordes, Jason Weston, Ronan Collobert, and Yoshua Bengio. "Learning Structured Embeddings of Knowledge Bases". In: *Proceedings of the Twenty-Fifth AAAI Conference on Artificial Intelligence*. AAAI'11. San Francisco, California: AAAI Press, 2011, pp. 301–306.
- [89] Antoine Bordes, Nicolas Usunier, Alberto Garcia-Durán, Jason Weston, and Oksana Yakhnenko. "Translating Embeddings for Modeling Multi-relational Data". In: *Proceedings of the 26th International Conference on Neural Information Processing Systems - Volume 2*. NIPS'13. Lake Tahoe, Nevada: Curran Associates Inc., 2013, pp. 2787–2795.
- [90] Antoine Bordes, Xavier Glorot, Jason Weston, and Yoshua Bengio. "A Semantic Matching Energy Function for Learning with Multi-relational Data". In: *Mach. Learn.* 94.2 (Feb. 2014), pp. 233–259.
- [91] Zhen Wang, Jianwen Zhang, Jianlin Feng, and Zheng Chen. "Knowledge Graph Embedding by Translating on Hyperplanes". In: *Proceedings of the Twenty-Eighth AAAI Conference on Artificial Intelligence*. AAAI'14. Quebec City, Quebec, Canada: AAAI Press, 2014, pp. 1112–1119.
- [92] Yankai Lin, Zhiyuan Liu, Maosong Sun, Yang Liu, and Xuan Zhu. "Learning Entity and Relation Embeddings for Knowledge Graph Completion". In: *Proceedings of the Twenty-Ninth AAAI Conference on Artificial Intelligence*. AAAI'15. Austin, Texas: AAAI Press, 2015, pp. 2181–2187.
- [93] Guoliang Ji, Shizhu He, Liheng Xu, Kang Liu, and Jun Zhao. "Knowledge Graph Embedding via Dynamic Mapping Matrix". In: *Proceedings of the 53rd Annual Meeting of the Association for Computational Linguistics and the 7th International Joint Conference on Natural Language Processing (Volume 1: Long Papers)*. Beijing, China: Association for Computational Linguistics, July 2015, pp. 687–696.
- [94] Maximilian Nickel, Volker Tresp, and Hans-Peter Kriegel. "A Three-way Model for Collective Learning on Multi-relational Data". In: *Proceedings of the 28th International Conference on International Conference on Machine Learning*. ICML'11. Bellevue, Washington, USA: Omnipress, 2011, pp. 809–816.

- [95] Xin Dong et al. “Knowledge Vault: A Web-scale Approach to Probabilistic Knowledge Fusion”. In: *Proceedings of the 20th ACM SIGKDD International Conference on Knowledge Discovery and Data Mining*. KDD '14. New York, New York, USA: ACM, 2014, pp. 601–610.
- [96] Bishan Yang, Wen-tau Yih, Xiaodong He, Jianfeng Gao, and Li Deng. “ Embedding Entities and Relations for Learning and Inference in Knowledge Bases ”. In: (Dec. 2014). arXiv: 1412.6575.
- [97] Tim Dettmers, Pasquale Minervini, Pontus Stenetorp, and Sebastian Riedel. “ Convolutional 2D Knowledge Graph Embeddings ”. In: (July 2017). arXiv: 1707.01476.
- [98] Bryan Perozzi, Rami Al-Rfou, and Steven Skiena. “ DeepWalk: Online Learning of Social Representations ”. In: (2014). arXiv: 1403.6652.
- [99] Nasrullah Sheikh, Zekarias Kefato, and Alberto Montresor. “ Gat2Vec: Representation Learning for Attributed Graphs ”. In: *Computing* (2018), pp. 1–23.
- [100] Aditya Grover and Jure Leskovec. “ Node2Vec: Scalable Feature Learning for Networks ”. In: *Proceedings of the 22Nd ACM SIGKDD International Conference on Knowledge Discovery and Data Mining*. KDD '16. New York, NY, USA: ACM, 2016, pp. 855–864. arXiv: 1607.00653v1.
- [101] Zheng Gao et al. “ edge2vec: Representation learning using edge semantics for biomedical knowledge discovery ”. In: (Sept. 2018). arXiv: 1809.02269.
- [102] Yuxiao Dong, Nitesh V. Chawla, and Ananthram Swami. “Metapath2Vec: Scalable Representation Learning for Heterogeneous Networks”. In: *Proceedings of the 23rd ACM SIGKDD International Conference on Knowledge Discovery and Data Mining*. KDD '17. Halifax, NS, Canada: ACM, 2017, pp. 135–144.
- [103] Jian Tang et al. “ LINE: Large-scale Information Network Embedding ”. In: (Mar. 2015). arXiv: 1503.03578.
- [104] Maximilian Nickel, Kevin Murphy, Volker Tresp, and Evgeniy Gabrilovich. “ A Review of Relational Machine Learning for Knowledge Graphs ”. In: *Proceedings of the IEEE* 104.1 (Jan. 2016), pp. 11–33.

- [105] L ´ eon Bottou. “ Large-scale machine learning with stochastic gradient descent ”. In: *Proceedings of COMPSTAT 2010 - 19th International Conference on Computational Statistics, Keynote, Invited and Contributed Papers* (2010), pp. 177–186.
- [106] M Girvan and M E J Newman. “ Community structure in social and biological networks. ” In: *Proceedings of the National Academy of Sciences of the United States of America* 99.12 (June 2002), pp. 7821–6.
- [107] Mehdi Ali, Charles Tapley Hoyt, Daniel Domingo-Fern ´ a ndez, Jens Lehmann, and Hajira Jabeen. “ BioKEEN: A library for learning and evaluating biological knowledge graph embeddings. ” In: *Bioinformatics (Oxford, England)* (Feb. 2019). Ed. by Jonathan Wren.
- [108] James L. Peterson. “Petri Nets”. In: *ACM Comput. Surv.* 9.3 (Sept. 1977), pp. 223–252.
- [109] Istv ´ a n Albert, Juilee Thakar, Song Li, Ranran Zhang, and R ´ e ka Albert. “ Boolean network simulations for life scientists ”. In: *Source Code for Biology and Medicine* 3 (2008), pp. 1–8.
- [110] Julio Saez-Rodriguez et al. “ Comparing signaling networks between normal and transformed hepatocytes using discrete logical models ”. In: *Cancer Research* 71.16 (2011), pp. 5400–5411.
- [111] Benjamin M Gyori, John A Bachman, Kartik Subramanian, Jeremy L Muhlich, and Lucian Galescu. “ From word models to executable models of signaling networks using automated assembly ”. In: *bioRxiv* (2017), p. 119834.
- [112] Guy Karlebach and Ron Shamir. “ Modelling and analysis of gene regulatory networks. ” In: *Nature reviews. Molecular cell biology* 9.10 (2008), pp. 770–780.
- [113] Carlos F. Lopez, Jeremy L. Muhlich, John A. Bachman, and Peter K. Sorger. “ Programming biological models in Python using PySB. ” In: *Molecular systems biology* 9.646 (2013), p. 646.
- [114] John Arrowsmith. “ Trial watch: phase III and submission failures: 2007-2010. ” In: *Nature reviews. Drug discovery* 10.2 (Feb. 2011), p. 87.
- [115] John Arrowsmith. “ Trial watch: Phase II failures: 2008-2010. ” In: *Nature reviews. Drug discovery* 10.5 (May 2011), pp. 328–9.

- [116] Isabella Gashaw, Peter Ellinghaus, Anette Sommer, and Khusru Asadullah. "What makes a good drug target?" In: *Drug discovery today* 17 Suppl (Feb. 2012), S24–30.
- [117] Zerrin Isik, Christoph Baldow, Carlo Vittorio Cannistraci, and Michael Schroeder. "Drug target prioritization by perturbed gene expression and network information." In: *Scientific reports* 5 (Nov. 2015), p. 17417.
- [118] Fleur L Moseley, Katrina A Bicknell, Michael S Marber, and Gavin Brooks. "The use of proteomics to identify novel therapeutic targets for the treatment of disease." In: *The Journal of pharmacy and pharmacology* 59.5 (May 2007), pp. 609–28.
- [119] Yves Moreau and L é on-Charles Tranchevent. "Computational tools for prioritizing candidate genes: boosting disease gene discovery". In: *Nature Reviews Genetics* 13.8 (2012), p. 523.
- [120] Dorothea Emig et al. "Drug target prediction and repositioning using an integrated network-based approach". In: *PLoS One* 8.4 (2013), e60618.
- [121] Jiyoun Lee and Matthew Bogoyo. "Target deconvolution techniques in modern phenotypic profiling ". In: *Current Opinion in Chemical Biology* 17.1 (2013), pp. 118–126.
- [122] Agustinus Kristiadi, Mohammad Asif Khan, Denis Lukovnikov, Jens Lehmann, and Asja Fischer. "Incorporating Literals into Knowledge Graph Embeddings ". In: (Feb. 2018). arXiv: 1802.00934.
- [123] M ´ a rton Vass et al. "Molecular interaction fingerprint approaches for GPCR drug discovery." In: *Current opinion in pharmacology* 30 (2016), pp. 59–68.
- [124] Petra Schneider and Gisbert Schneider. "Polypharmacological Drug-target Inference for Chemogenomics." In: *Molecular informatics* 37.9-10 (2018), e1800050.
- [125] Gerard J P Van Westen, J??rg K. Wegner, Adriaan P. Ijzerman, Herman W T Van Vlijmen, and A. Bender. "Proteochemometric modeling as a tool to design selective compounds and for extrapolating to novel targets ". In: *MedChemComm* 2.1 (2011), pp. 16–30.

- [126] Alpha Tom Kodamullil, Erfan Younesi, Mufassra Naz, Shweta Bagewadi, and Martin Hofmann-Apitius. “ Computable cause-and-effect models of healthy and Alzheimer’s disease states and their mechanistic differential analysis. ” eng. In: *Alzheimer’s & dementia : the journal of the Alzheimer’s Association* 11.11 (Nov. 2015), pp. 1329–1339.
- [127] Afroza Khanam Irin, Alpha Tom Kodamullil, Michaela G ¨ u ndel, and Martin Hofmann-Apitius. “ Computational Modelling Approaches on Epigenetic Factors in Neurodegenerative and Autoimmune Diseases and Their Mechanistic Analysis ”. In: *Journal of Immunology Research* 2015 (2015).
- [128] Mufassra Naz, Alpha Tom Kodamullil, and Martin Hofmann-Apitius. “ Reasoning over genetic variance information in cause-and-effect models of neurodegenerative diseases. ” In: *Briefings in bioinformatics* 17.3 (2016), pp. 505–16.
- [129] Reagon Karki, Alpha Tom Kodamullil, and Martin Hofmann-Apitius. “ Comorbidity Analysis between Alzheimer’s Disease and Type 2 Diabetes Mellitus (T2DM) Based on Shared Pathways and the Role of T2DM Drugs ”. In: *Journal of Alzheimer’s Disease* 60.2 (2017), pp. 721–731.
- [130] Mohammad Asif Emran Khan Emon, Alpha Tom Kodamullil, Reagon Karki, Erfan Younesi, and Martin Hofmann-Apitius. “ Using Drugs as Molecular Probes: A Computational Chemical Biology Approach in Neurodegenerative Diseases ”. In: *Journal of Alzheimer’s Disease* 56.2 (2017), pp. 677–686.
- [131] Daniel Domingo-Fern ´ a ndez et al. “ Multimodal Mechanistic Signatures for Neurodegenerative Diseases (NeuroMMSig): a web server for mechanism enrichment ”. In: *Bioinformatics (Oxford, England)* btx399 (2017).
- [132] Mehdi Ali, Sumit Madan, Asja Fischer, Henning Petzka, and Juliane Fluck. “ Automatic Extraction of BEL-Statements based on Neural Networks ”. In: *Proceedings of BioCreative VI Challenge and Workshop* October (2017).
- [133] Thomas Kluyver et al. “ Jupyter Notebooks—a publishing format for reproducible computational workflows ”. In: *Positioning and Power in Academic Publishing: Players, Agents and Agendas* (2016), pp. 87–90.

- [134] Mark D M Leiserson et al. " Pan-cancer network analysis identifies combinations of rare somatic mutations across pathways and protein complexes. " In: *Nature genetics* 47.2 (Feb. 2015), pp. 106–14. arXiv: 15334406.
- [135] C. Ebeling, A. Konotopez, C. T. Hoyt, and D. Domingo-Fernández. " Software framework for the analysis of causal and correlative biomedical knowledge graphs ". In: PHAGO General Assembly, 2017.
- [136] Dexter Pratt et al. " NDEx, the Network Data Exchange ". In: *Cell Systems* 1.4 (2015), pp. 302–305.
- [137] Daniel Domingo-Fernandez et al. " ComPath: an ecosystem for exploring, analyzing, and curating mappings across pathway databases ". In: *npj Systems Biology and Applications* 5.1 (2018), p. 3.
- [138] Sarah Mubeen et al. " The Impact of Pathway Database Choice on Statistical Enrichment Analysis and Predictive Modeling ". In: *bioRxiv* (Jan. 2019), p. 654442.
- [139] Mijin Kwon et al. " CODA-ML: Context-specific biological knowledge representation for systemic physiology analysis ". In: *BMC Bioinformatics* 20.Suppl 10 (2019).
- [140] Raul Rodriguez-Esteban. " Biocuration with insufficient resources and fixed timelines ". In: *Database* 2015.1 (2015), pp. 1–9.
- [141] Denise N Slenter et al. " WikiPathways: a multifaceted pathway database bridging metabolomics to other omics research. " In: *Nucleic acids research* 46.D1 (Jan. 2018), pp. D661–D667.
- [142] D ´ e nes T ´ u rei, Tam ´ a s Korcsm ´ a ros, and Julio Saez-Rodriguez. " OmniPath: guidelines and gateway for literature-curated signaling pathway resources ". In: *Nature Methods* 13.12 (Dec. 2016), pp. 966–967.
- [143] Vanessa Schmidt et al. " Quantitative modelling of amyloidogenic processing and its influence by SORLA in Alzheimer’s disease ". In: *The EMBO Journal* 31.1 (Jan. 2012), pp. 187–200.
- [144] Paul Stapor et al. " PESTO: Parameter ESTimation TOolbox ". In: *Bioinformatics* 34.4 (Feb. 2018). Ed. by Jonathan Wren, pp. 705–707.

- [145] Tian Qi Chen, Yulia Rubanova, Jesse Bettencourt, and David Duvenaud. “Neural Ordinary Differential Equations”. In: *CoRR* abs/1806.07366 (2018). arXiv: 1806.07366.
- [146] Yohai Bar-Sinai, Stephan Hoyer, Jason Hickey, and Michael P Brenner. “ Learning data-driven discretizations for partial differential equations ”. In: *Proceedings of the National Academy of Sciences* 116.31 (2019), pp. 15344–15349.
- [147] Mike Innes et al. “A Differentiable Programming System to Bridge Machine Learning and Scientific Computing”. In: *CoRR* abs/1907.07587 (2019). arXiv: 1907.07587.
- [148] Daniel Scott Himmelstein et al. “ Systematic integration of biomedical knowledge prioritizes drugs for repurposing. ” In: *eLife* 6 (Sept. 2017).
- [149] Pascale Gaudet et al. “ The neXtProt knowledgebase on human proteins: 2017 update ”. In: *Nucleic Acids Research* 45.D1 (Jan. 2017), pp. D177–D182.
- [150] David S Wishart et al. “ DrugBank 5.0: a major update to the DrugBank database for 2018. ” In: *Nucleic acids research* 46.D1 (Jan. 2018), pp. D1074–D1082.