

Technical Report Test-M-I Study: Psychometric and Validation Analyses for the Revised WINT-Check

Technical Report Version: 4.00

Principle Investigator: Prof. Dr. Fani Lauermann (fani.lauermann@uni-bonn.de)
Psychometric Analyses: Dr. Jeffrey M. DeVries (jdevries@uni-bonn.de)
Validation Study: Dr. Daria Benden (daria.benden@uni-bonn.de)

Project Test-M-I was carried out in close collaboration with Project Test-M-II, led by Prof. Dr. Johanna Heitzer (johanna.heitzer@matha.rwth-aachen.de), who was responsible for developing the test math content. The validated test was programmed by Marcel Ritz, M.Ed. (marcel.ritz@rwth-aachen.de). For all questions related to the math content of the test, please contact the Test-M-II project lead.

Cite this report and all included analyses as:

Lauermann, F., DeVries, J. M., & Benden, D. K. (2023). *Technical Report Test-M-I Study: Psychometric and Validation Analyses for the Revised WINT-Check (Version 4.00)*. bonndoc – The Repository of the University of Bonn.
<https://doi.org/10.48565/bonndoc-146>

In Kooperation mit:

Gefördert durch:

**** This is a blinded version of the report ****

This report contains psychometric details of each math problem included in the test WINT-Check (<https://www.orca.nrw/assessments/wint-check>). To protect the integrity of the test, this blinded version of the report **does not** include answers to the analyzed math problems.

For a full description of all math problems, correct answers, distractors, rates of correct and incorrect responses, and the frequency at which each answer option is chosen, refer to the full version of the report. The full version is available upon request from the principal investigator of the Test-M-I project (Prof. Dr. Fani Lauermann, fani.lauermann@uni-bonn.de).

When citing the report, please refer to the blinded version:

Lauermann, F., DeVries, J. M., & Benden, D. K. (2023). *Technical Report Test-M-I Study: Psychometric and Validation Analyses for the Revised WINT-Check (Version 4.00)*. bonndoc – The Repository of the University of Bonn.
<https://doi.org/10.48565/bonndoc-146>

Table of Contents

1. INTRODUCTION AND OVERVIEW OF THE MATH TEST WINT-CHECK	7
1.1. Test Description	7
1.2. Multi-Matrix Design	8
1.3. Model Specifications	13
1.4. Partial Credit Scoring	16
1.5. Sample Description	17
2. RELIABILITY ESTIMATES AND BASIC INFORMATION FOR THE OVERALL TEST	19
2.1. Marginal Estimates of Reliability Based on Weighted Likelihood Estimates (WLE) of Ability	19
2.2. Test Information Function.....	24
2.3. Residual Correlations (Q ₃ Statistics)	29
2.4. Differential Item Functioning (DIF)	29
2.5. Subscale Correlation Matrices	31
2.6. Difficulty Ranges of Thurstonian Thresholds	31
3. OVERVIEW OF PSYCHOMETRIC INFORMATION PROVIDED FOR EACH SUBSCALE AND ITEM	35
3.1. Q ₃ Statistics	35
3.2. Problem-Specific Information	35
3.3. Psychometric Characteristics	35
3.3.1. Discrimination	35
3.3.2. Difficulty	35
3.3.3. Cumulative Probability for an Average Participant	36
3.3.4. Frequencies of Attained Points.....	36
3.3.5. Graphs	37
3.3.6. Differential Item Functioning (DIF).....	37
4. PERFORMANCE OF EACH SCALE AND ITEM	38
4.1. Basic Arithmetic Operations (Grundrechenarten und Zahlbereiche; GR)	38
4.1.1. Conversion of Fractions to Decimal Fractions (GR1)	39
4.1.2. Fractions and Decimal Fractions (GR2)	42
4.1.3. Fractions, Decimal Numbers, Percent (GR3)	45
4.1.4. Decimal Fractions (GR4)	48
4.1.5. Calculations With Fractions (GR5)	50
4.1.6. Comparing Sales, Calculations With Percent (GR6)	52
4.1.7. Price and Weight (GR7).....	55
4.1.8. Work and Time Requirements (GR8)	58
4.1.9. Lowest Common Denominator in Fractions (GR9)	61
4.1.10. Conversions Between Fraction Representations (GR10)	66
4.1.11. Decimal Representation (GR11)	71
4.1.12. Sets (GR12)	72
4.1.13. Estimation / Rough Calculations (GR13)	76
4.2. Exponents, Roots, Logarithms (Potenzen, Wurzeln, Logarithmen; P).....	79
4.2.1. Simplification and Calculating Rational Denominators (P1)	80
4.2.2. Power-of-ten Notation (P2)	83
4.2.3. Simplifying Exponents (P3).....	86
4.2.4. Calculating Exponents (P4)	89
4.2.5. Calculations With Exponents (P5)	92
4.2.6. Compound Interest (P6)	96
4.2.7. Inverse Operations (P7).....	98
4.2.8. Equation With Exponents (P8)	101
4.2.9. Root Equations (P9)	104
4.2.10. Laws of Logarithms (P10).....	106

4.3. Terms and Equations (Terme und Gleichungen; TG)	110
4.3.1. Binomial Formulas (TG1)	111
4.3.2. Simplifying Terms (TG2)	114
4.3.3. Volume of a Prism (TG3)	117
4.3.4. Equivalent Transformations (TG4)	120
4.3.5. Simple Equations (TG5)	123
4.3.6. Equation With a Parameter (TG6)	127
4.3.7. Fractional Equations (TG7)	130
4.3.8. Graphical Representation of Solution Sets (TG8)	132
4.3.9. Sign Questions (TG9)	136
4.3.10. Matchstick Figure (TG10)	139
4.4. Elementary Functions (Elementare Funktionen; EF)	142
4.4.1. Function Values (EF1)	143
4.4.2. Domain and Value Sets (EF2)	147
4.4.3. Point Symmetry (EF3)	151
4.4.4. Lines (EF4)	153
4.4.5. Parabolas (EF5)	157
4.4.6. Intersection Points (EF6)	160
4.4.7. Slope Properties (EF7)	163
4.4.8. Value Tables for Graphs of a Function (EF8)	167
4.4.9. Argument and Function Values (EF9)	171
4.4.10. Simple and Double Null States (EF10)	174
4.5. Elementary Geometry (Elementare Geometrie; G)	177
4.5.1. Measurement Units (G1)	178
4.5.2. Determining Angle Sizes (G2)	182
4.5.3. Areas (G3)	186
4.5.4. Volumes of Standard Figures (G4)	191
4.5.5. Volume (G5)	195
4.5.6. Tangents of Circles (G6)	198
4.5.7. Similarity and Radius Ratios (G7)	201
4.5.8. Statements About Congruence (G8)	204
4.5.9. Symmetry (G9)	208
4.5.10. Homothety (G10)	212
4.6. Trigonometry (Trigonometrie; TR)	215
4.6.1. Aspect Ratios in a Right Triangle (TR1)	216
4.6.2. Sine and Cosine in the Unit Circle (TR2)	220
4.6.3. Angle Measurements (TR3)	226
4.6.4. Sine Values (TR4)	230
4.6.5. Trigonometric Pythagoras (TR5)	234
4.6.6. Interrelationships in Right Triangles (TR6)	237
4.6.7. Side Lengths in Triangles (TR7)	240
4.6.8. Sine and Cosine (TR8)	243
4.6.9. Reading on the Unit Circle (TR9)	246
4.6.10. Symmetry of Sine and Cosine (TR10)	249
4.7. Higher Functions (Höhere Funktionen; HF)	252
4.7.1. Graphs of Known Functions (HF1)	253
4.7.2. Transformation of Graphs (HF2)	258
4.7.3. Null states (HF3)	263
4.7.4. Important Limits (HF4)	267
4.7.5. Parameters of a Sine Function (HF5)	271
4.7.6. Value Tables (HF6)	275
4.7.7. Composite Functions (HF7)	278
4.7.8. Functions in Applied Contexts (HF8)	282
4.7.9. Domain of a Function (HF9)	285
4.7.10. Domain and Value Sets of Higher Functions (HF10)	288
4.8. Differential Calculus (Differentialrechnung; D)	292
4.8.1. First Derivative of Polynomial Functions (D1)	293

4.8.2.	Laws of Derivatives (D2).....	296
4.8.3.	Meaning of the First and Second Derivative (D3).....	299
4.8.4.	Derivative Function (D4).....	302
4.8.5.	Tangent Slope (D5).....	307
4.8.6.	Tangent Equation (D6).....	310
4.8.7.	Curve Sketching (Extreme and Inflection Points) (D7).....	313
4.8.8.	Extreme Points of Functions (D8).....	317
4.8.9.	Difference Quotient (D9).....	320
4.8.10.	Average Slopes (D10).....	323
4.8.11.	Statements About Derivatives (D11).....	326
4.9.	Integral Calculus (Integralrechnung; I).....	330
4.9.1.	Main Theorem of Differential and Integral Calculus (I1).....	331
4.9.2.	Antiderivative of Known Functions (I2).....	334
4.9.3.	Graphs and Antiderivatives (I3).....	339
4.9.4.	Integration Bounds (I4).....	343
4.9.5.	Areas (I5).....	346
4.9.6.	Totals and Integrals (I6).....	349
4.9.7.	Oriented Areas and Interval Additivity (I7).....	352
4.9.8.	“Area – Indefinite?” (I8).....	355
4.9.9.	Integrations of a Monomial (I9).....	358
4.9.10.	Antiderivative (I10).....	361
4.10.	Linear Equation Systems (Lineare Gleichungssysteme; L).....	365
4.10.1.	Verifying Solutions (L1).....	366
4.10.2.	2x2 With a Parameter (L2).....	369
4.10.3.	Parameter Based Solutions of Linear Equation Systems (L3).....	372
4.10.4.	Specifying Coefficients (L4).....	376
4.10.5.	Matrix and Vector (L5).....	380
4.10.6.	Graphically Solving Linear Equation Systems (L6).....	383
4.10.7.	Matrix and Vector Notation (L7).....	386
4.10.8.	Choosing Appropriate Procedures to Solve a Linear Equation System (L8).....	389
4.10.9.	Conversions in Linear Equation Systems (L9).....	392
4.10.10.	Graphic Interpretation of a Solution Set (L10).....	395
4.10.11.	Concept of Linear Equation Systems (L11).....	398
4.10.12.	Linear Equation Systems for Lines (L12).....	402
4.11.	Vectors and Analytical Geometry (Vektoren und Analytische Geometrie; V).....	403
4.11.1.	Linear Combination (V1).....	404
4.11.2.	Vectors and Scalars (V2).....	407
4.11.3.	Calculating Scalar Products (V3).....	412
4.11.4.	Interpreting Scalar Products (V4).....	415
4.11.5.	Normal Vector (V5).....	418
4.11.6.	Angle Between two Lines (V6).....	421
4.11.7.	Reading a Position Vector (V7).....	424
4.11.8.	Linking Vector and Length of a Vector (V8).....	428
4.11.9.	Position Problems (V9).....	431
4.11.10.	Determination of a Plane (V10).....	437
4.11.11.	Positional Relationship of Lines and Planes (V11).....	442
4.11.12.	Orthogonality (V12).....	446
4.11.13.	Linear Dependence (V13).....	449
5.	QUALITATIVE ANALYSES OF MATH PROBLEMS THAT WERE CHANGED AFTER THE MAIN STUDY FOR THE FINAL IMPLEMENTATION IN ORCA.NRW.....	453
5.1.	(Lowest) Common Denominator in Fractions (GR9).....	454
5.2.	Sets (Numerical Ranges) (GR12).....	455
5.3.	Lines (EF4).....	456
5.4.	Symmetry (G9).....	457
5.5.	Difference Quotient (D9).....	458
5.6.	Integration of a Monomial (I9).....	459

5.7. Position Problems (V9)	460
6. VALIDATION ANALYSES	461
7. REFERENCES	464
8. APPENDIX	466
8.1. Changed Problems in Partial Credit Scoring Version 4 (PCS4)	466
8.1.1. Lowest Common Denominator in Fractions (GR9)	466
8.1.2. Decimal Representation (GR11)	471
8.1.3. “Area – Indefinite?” (I8).....	474
8.1.4. Linear Equation Systems for Lines (L12)	479
8.2. R Scripts	482
8.2.1. Script for Data Import.....	482
8.2.2. Script for Base PCS4-Models	486
8.2.3. Script to Calculate PV and Theta Values	493
8.2.4. Script for DIF Analyses	501
8.2.5. Script for True Score Equating	504

1. Introduction and Overview of the Math Test WINT-Check

1.1. Test Description

This report details psychometric analyses based on item-response theory (IRT) models for all items included in the most recent revision of the so-called **WINT-Check**, an online math self-test for students interested in pursuing a postsecondary degree in math-related fields (i.e., economics, engineering, computer science, the natural sciences, and other technology-related disciplines). The test is available in the **orca.nrw** portal of the state of North Rhine-Westphalia (NRW; orca.nrw/assessments/wint-check).

The **test version used to validate the WINT-Check** initially included **119** math problems across **11** subscales in **10** math content areas. The ten math content areas were selected by representatives of all public universities and universities of applied sciences in NRW and the Ministry of Culture and Science of the State of NRW in 2015 (see WINT-Check Mathematik: Handreichung, 2017). These content areas are described in the so-called “WINT-Catalogue” as standards for mathematical knowledge (i.e., math prerequisites) for students interested in pursuing a postsecondary degree in math-intensive study programs in NRW.

Most math problems include multiple parts and thus require **partial credit scoring**. Four scoring versions, explained in greater detail in **Section 1.4**, were implemented to account for interdependencies in the students' responses to different parts of the same math problem. Partial credit scoring version 1 (**PCS1**) included a maximum of 283 partial credit points (0 = incorrect response, 1 = correct response to a math problem part). Version 2 (**PCS2**) reduced the number of partial credit points to 259, and version 3 (**PCS3**) further reduced it to 242; these reductions were guided by psychometric analyses that identified redundancies in the scoring. In the final partial credit scoring version 4 (**PCS4**), two math problems were removed due to poor psychometric properties, and two additional math problems were shortened (i.e., parts were removed due to redundancy), which reduced the total number of math problems to **117** and the total number of partial credit points to **235** (see **Section 1.4** for further details).

Table 1 shows an overview of the 10 math content areas, 11 subscales, and the number of items across the four partial credit scoring versions. Each of the 11 subscales takes about 20 minutes to complete.

Table 1. Number of Math Problems and Points for Each Subscale and Domain for PCS1–4

Subscale	Math Content Area	# Math Problems (PCS1–3)	# Math Problems (PCS4)	# Points (PCS1)	# Points (PCS2)	# Points (PCS3)	# Points (PCS4)
1. Basic Arithmetic Operations	Basic Arithmetic Operations	13	12	37	27	27	25
2. Exponents, Roots, Logarithms	Exponents, Roots, Logarithms	10	10	22	19	19	19
3. Terms and Equations	Terms and Equations	10	10	21	19	17	17
4. Elementary Functions	Functions	10	10	22	19	19	19
5. Elementary Geometry	Elementary Geometry	10	10	24	24	24	24
6. Trigonometry	Trigonometry	10	10	19	19	19	19
7. Higher Functions	Functions	10	10	25	25	25	25
8. Differential Calculus	Differential Calculus	11	11	21	21	18	18
9. Integral Calculus	Integral Calculus	10	10	24	24	20	18
10. Linear Equation Systems	Linear Equation Systems	12	11	27	26	20	19
11. Vectors and Analytical Geometry	Vectors and Analytical Geometry	13	13	41	36	31	31
Total		119	117	283	259	239	234

Note. The math content area “Functions” is represented by two subscales: elementary and higher functions.

Due to the number of math problems, subscales, and related time constraints, a **multi-matrix design** was implemented (e.g., see Adams & Gonzalez, 1996), which we describe in greater detail in the following section. We created **22 booklets**, each of which covered only some of the math problems. This allowed for completing a test booklet in approximately **45-60 minutes**, including questions about demographics and subjective evaluations of the math problems (e.g., level of interest, perceived relevance of math content for the study program). The 11 subscales were distributed across multiple booklets in a consistent pattern (see **Section 1.2**).

Note that **7 out of the 117 math problems were modified** for the final implementation of the WINT-Check in orca.nrw. These changes were deemed necessary by content experts. Qualitative interviews with students from the target population were conducted using cognitive pretesting (Karabenick et al., 2007) to evaluate whether the interpretation of these seven math problems differed before and after the implemented modifications (e.g., did changes in terminology or typos affect students' interpretation of the math problems). These qualitative analyses are described in **Section 5** and indicated that students interpreted the seven math problems as intended, regardless of the modifications, but agreed that the modifications (e.g., adjusted instructions, corrected typos) make the interpretation more straightforward. All changes are described in **Section 5**.

1.2. Multi-Matrix Design

As shown in **Table 2** and **Table 3**, a multi-matrix design was used to create **22 booklets** with partly overlapping math content that were assigned to participants at random (see Adams & Gonzalez, 1996). Data from previous versions of the WINT-Check were relied on to create booklets of approximately equal duration and difficulty. We used expert ratings (collaborators in Project Test-M-II) for newly developed items to determine the expected item difficulty and amount of test time required.

First, based on this information, each subscale was divided into halves of approximately equal length and difficulty using the "Solver.xlam" in Microsoft Excel (Parts A and B, see **Table 3**). The "Solver.xlam" is an add-in for Microsoft Excel that provides optimization and equation-solving capabilities. A key constraint for splitting the subscales was that neither half could exceed 10 minutes of expected test time. Second, the "Solver.xlam" tool was then used to create 22 booklets with a similar average difficulty and duration, each containing four subscale halves (Parts 1-4, **Table 2**). The content of the booklets partly overlapped in a systematic pattern (see **Table 2**) to allow for linking students' performance across booklets. Finally, the booklets were modified to allow for effective icebreaker questions, so none started with advanced math content (e.g., calculus). That is, items from subscales 6 through 11, which capture comparatively more advanced content (see **Table 3**), were moved to a later position within the same booklet, and a less advanced subscale half from that same booklet (i.e., items from subscales 1 through 5) was moved to the first position. This adjustment ensured that all students started the test with a less advanced math content area as a means to reduce test dropout.

The final booklet design is shown in **Table 2**, and an overview of the scale halves is presented in **Table 3**. Half of each subscale was included in 4 to 5 booklets, and each participant worked on content from 2 to 3 subscales.

Table 2. Multi-Matrix Design With 22 Booklets

Booklet	Booklet Part 1	Booklet Part 2	Booklet Part 3	Booklet Part 4
#1	Elementary Geometry A	Elementary Geometry B	Integral Calculus A	Integral Calculus B
#2	Elementary Geometry B	Integral Calculus A	Integral Calculus B	Terms and Equations A
#3	Terms and Equations A	Integral Calculus A	Integral Calculus B	Terms and Equations B
#4	Terms and Equations A	Integral Calculus B	Terms and Equations B	Differential Calculus A
#5	Terms and Equations A	Terms and Equations B	Differential Calculus A	Differential Calculus B
#6	Terms and Equations B	Differential Calculus A	Differential Calculus B	Basic Arithmetic Operations A
#7	Basic Arithmetic Operations A	Differential Calculus A	Differential Calculus B	Basic Arithmetic Operations B
#8	Basic Arithmetic Operations A	Differential Calculus B	Basic Arithmetic Operations B	Linear Equation Systems A
#9	Basic Arithmetic Operations A	Basic Arithmetic Operations B	Linear Equation Systems A	Linear Equation Systems B
#10	Basic Arithmetic Operations B	Linear Equation Systems A	Linear Equation Systems B	Elementary Functions A
#11	Elementary Functions A	Linear Equation Systems A	Linear Equation Systems B	Elementary Functions B
#12	Elementary Functions A	Linear Equation Systems B	Elementary Functions B	Vectors and Analytical Geometry A
#13	Elementary Functions A	Elementary Functions B	Vectors and Analytical Geometry A	Vectors and Analytical Geometry B
#14	Elementary Functions B	Vectors and Analytical Geometry A	Vectors and Analytical Geometry B	Higher Functions A
#15	Higher Functions A	Vectors and Analytical Geometry A	Vectors and Analytical Geometry B	Higher Functions B
#16	Exponents, Roots, Logarithms A	Vectors and Analytical Geometry B	Higher Functions A	Higher Functions B
#17	Exponents, Roots, Logarithms A	Higher Functions A	Higher Functions B	Exponents, Roots, Logarithms B
#18	Exponents, Roots, Logarithms A	Higher Functions B	Exponents, Roots, Logarithms B	Trigonometry A
#19	Exponents, Roots, Logarithms A	Exponents, Roots, Logarithms B	Trigonometry A	Trigonometry B
#20	Exponents, Roots, Logarithms B	Trigonometry A	Trigonometry B	Elementary Geometry A
#21	Elementary Geometry A	Trigonometry A	Trigonometry B	Elementary Geometry B
#22	Elementary Geometry A	Trigonometry B	Elementary Geometry B	Integral Calculus A

Note. “A” and “B” each refer to separate halves of the same subscale. See **Section 1.2** for more information about the splitting of subscales.

Table 3. Overview of Scale Halves and Order in Which the Problems Were Presented

Subscale	Scale Half A		Scale Half B	
	Problem ID	Problem Name	Problem ID	Problem Name
Basic Arithmetic Operations	GR6	Comparing Sales, Calculations With Percent	GR9	Lowest Common Denominator in Fractions
	GR2	Fractions and Decimal Fractions	GR3	Fractions, Decimal Numbers, Percent
	GR1	Conversion of Fractions to Decimal Fractions	GR4	Decimal Fractions
	GR7	Price and Weight	GR5	Calculations With Fractions
	GR8	Work and Time Requirements	GR10	Conversions Between Fraction Representations
	GR11	Decimal Representation	GR13	Estimation / Rough Calculations
	GR12	Sets		
Exponents, Roots, Logarithms	P6	Compound Interest	P2	Power-of-ten Notation
	P1	Simplification and Calculating Rational Denominators	P4	Calculating Exponents
	P7	Inverse Operations	P5	Calculations With Exponents
	P3	Simplifying Exponents	P8	Equation With Exponents
	P10	Laws of Logarithms	P9	Root Equations
Terms and Equations	TG7	Fractional Equations	TG1	Binomial Formulas
	TG4	Equivalent Transformations	TG2	Simplifying Terms
	TG6	Equation With a Parameter	TG3	Volume of a Prism
	TG8	Graphical Representation of Solution Sets	TG5	Simple Equations
	TG9	Sign Questions	TG10	Matchstick Figure
Elementary Functions	EF4	Lines	EF1	Function Values
	EF6	Intersection Points	EF2	Domain and Value Sets
	EF7	Slope Properties	EF3	Point Symmetry
	EF8	Value Tables for Graphs of a Function	EF9	Argument and Function Values
	EF10	Simple and Double Null States	EF5	Parabolas

Subscale	Scale Half A		Scale Half B	
	Problem ID	Problem Name	Problem ID	Problem Name
Elementary Geometry	G2	Determining Angle Sizes	G1	Measurement Units
	G4	Volumes of Standard Figures	G3	Areas
	G5	Volume	G9	Symmetry
	G6	Tangents of Circles	G8	Statements About Congruence
	G10	Homothety	G7	Similarity and Radius Ratios
Trigonometry	TR5	Trigonometric Pythagoras	TR1	Aspect Ratios in a Right Triangle
	TR2	Sine and Cosine in the Unit Circle	TR9	Reading on the Unit Circle
	TR3	Angle Measurements	TR4	Sine Values
	TR7	Side Lengths in Triangles	TR8	Sine and Cosine
	TR10	Symmetry of Sine and Cosine	TR6	Interrelationships in Right Triangles
Higher Functions	HF1	Graphs of Known Functions	HF2	Transformation of Graphs
	HF3	Null States	HF4	Important Limits
	HF7	Composite Functions	HF8	Functions in Applied Contexts
	HF10	Domain and Value Sets of Higher Functions	HF9	Domain of a Function
	HF5	Parameters of a Sine Function	HF6	Value Tables
Differential Calculus	D9	Difference Quotient	D10	Average Slopes
	D11	Statements About Derivatives	D1	First Derivative of Polynomial Functions
	D3	Meaning of the First and Second Derivative	D2	Laws of Derivatives
	D4	Derivative Function	D5	Tangent Slope
	D6	Tangent Equation	D7	Curve Sketching (Extreme and Inflection Points)
Integral Calculus	I9	Integrations of a Monomial	I10	Antiderivative
	I2	Antiderivative of Known Functions	I6	Totals and Integrals
	I5	Areas	I4	Integration Bounds
	I3	Graphs and Antiderivatives	I8	“Area – Indefinite?”
	I7	Oriented Areas and Interval Additivity	I1	Main Theorem of Differential and Integral Calculus

Subscale	Scale Half A		Scale Half B	
	Problem ID	Problem Name	Problem ID	Problem Name
Linear Equation Systems	L8	Choosing Appropriate Procedures to Solve a Linear Equation System	L10	Graphic Interpretation of a Solution Set
	L9	Conversions in Linear Equation Systems	L7	Matrix and Vector Notation
	L12	Linear Equation Systems for Lines	L11	Concept of Linear Equation Systems
	L1	Verifying Solutions	L3	Parameter Based Solutions of Linear Equation Systems
	L2	2x2 With a Parameter	L4	Specifying Coefficients
	L6	Graphically Solving Linear Equation Systems	L5	Matrix and Vector
Vectors and Analytical Geometry	V12	Orthogonality	V10	Determination of a Plane
	V13	Linear Dependence	V11	Positional Relationship of Lines and Planes
	V1	Linear Combination	V2	Vectors and Scalars
	V5	Normal Vector	V3	Calculating Scalar Products
	V8	Linking Vector and Length of a Vector	V4	Interpreting Scalar Products
	V9	Position Problems	V6	Angle Between two Lines
			V7	Reading a Position Vector

1.3. Model Specifications

We report analyses from four types of models based on item response theory (IRT, see **Figure 1**): First, we tested 11 separate unidimensional models (**Models A1-A11**) for each of the 11 subscales. Second, we tested a unidimensional model (**Model B**) that estimates students' overall math ability (theta, θ) across all 117 math problems and disregards the potentially multidimensional structure in the data based on the 11 subscales. Third, **Model C** is a variation of **Model B**, where the subscale-specific sums of factor loadings are constrained to be equal in all subscales. Due to this constraint, the 11 subscales contribute equal amounts of information to the estimation of the overall θ , even though the subscales had different numbers of problems and problem parts. Fourth, we tested a second-order, multidimensional model (**Model D**). **Model D** is a multidimensional IRT model that evaluates 11 interrelated ability dimensions representing the 11 subscales. The 11 ability estimates are then combined with equal weights into a second-order factor representing students' overall math ability. This model best represents the presumed 11-dimensional structure of the data, as well as the interrelations between the 11 subscales. However, it is also by far the most complex model and thus poses several estimation challenges (e.g., software and hardware limitations).

We report **Models A1-A11, B, C, and D** for the sake of comparison. Their results are generally consistent. **Figure 1** shows all types of models. Note that **Model D** incorporates the same modeling structure for each subdimension as **Models A1-A11**, but models the second-order factor as a formative factor (i.e., the single-order factors predict the second-order factor). For further information on this type of model, see Robitzsch and Steinfield (2018).

In all cases, the estimated math ability parameter (θ) was standardized with a mean of zero and a standard deviation of 1.

Figure 1. A Schematic Representation of the Four Types of Models

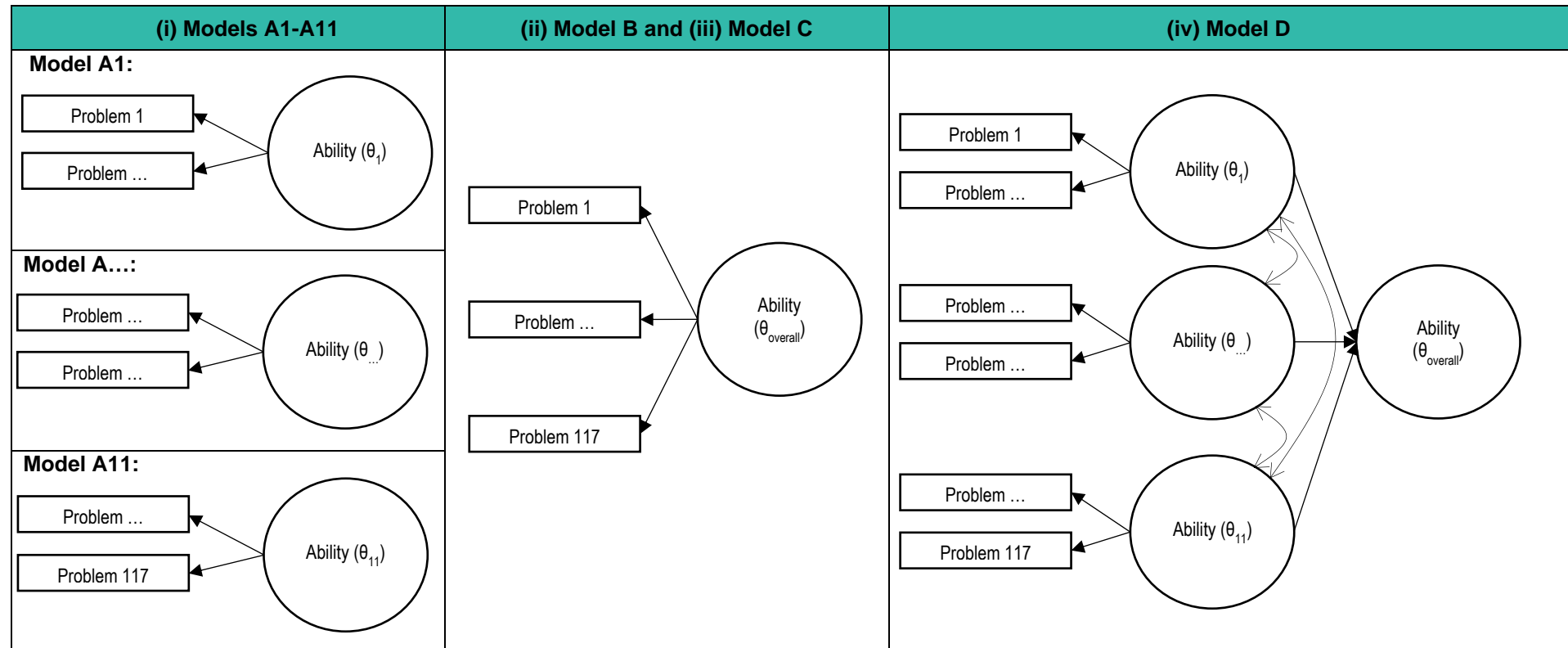

Note. **Models A1-A11** (i) are 11 separate unidimensional models. **Model B** (ii) is a unidimensional model with no restrictions on the factor loadings, and **Model C** (iii) introduces restrictions on the factor loadings so that the sum of the loadings for each subscale is equal to each other. Consequently, each subscale in Model C provides the same amount of information for the estimation of students' overall ability ($\theta_{overall}$) despite differing numbers of items across subscales. **Model D** (iv) is a multidimensional, second-order factor model including 11 interrelated subscales.

All reported IRT models (**Models A1-A11, B, C, and D**) are based on a 2PL generalized partial credit model (GPCM). In a GPCM, the probability of earning a specific number of points on a given math problem depends on three parameters: β is the difficulty parameter of a given math problem (i.e., how challenging it is to solve), α is the discrimination parameter (i.e., how well an item differentiates between participants with varying ability levels), and θ is the ability level of the participant. The model's probability equation is

$$P_{jk}(\theta) = \frac{\exp[\sum_{v=1}^k Z_{jv}(\theta)]}{\sum_{c=1}^{m_j} \exp[\sum_{v=1}^c Z_{jv}(\theta)]}$$

and

$$Z_{jk}(\theta) = D\alpha_j(\theta - \beta_{jk}) = D\alpha_j(\theta - \beta_j + d_k),$$

where D is a scaling constant equal to 1.7, to enable θ estimation on a logit scale, β_{jk} is an item category based on the partial credit for a given math problem, β_j is an item location parameter indicating the level of difficulty, α_j is the slope (i.e., the discrimination parameter representing the strength of the association between a given item and theta), and d_k is the category parameter (Muraki, 1992, 1997). For example, for a problem with four answer categories (i.e., up to 4 points can be earned by responding correctly to four math problem parts), the probability of category d_k (e.g., 3 points) depends on the ability of the responder (θ), the difficulty of the problem (β), and the discriminatory power of the problem (α).

The final unidimensional GPCM **Models A1-A11** and **B** were compared against a 1PL partial credit model, as reported in **Table 4**. In each case, the 2PL model had a superior fit to the data and was retained for subsequent analyses. Alternative models, such as a graded response model, had a comparable fit to the data and are not reported (also see Cook et al., 1999). The syntax for all tested models is presented in **Appendix 8.2**.

Table 4. Likelihood Ratio Tests Comparing 1PL Partial Credit and 2PL Generalized Partial Credit Models

Model	Subscale(s)	AIC (1PL)	AIC (2PL)	χ^2	df	p
Model A1	1. Basic Arithmetic Operations	10444	10410	56	11	< .001
Model A2	2. Exponents, Roots, Logarithms	8908	8795	131	9	< .001
Model A3	3. Terms and Equations	8162	8129	51	9	< .001
Model A4	4. Elementary Functions	8847	8769	96	9	< .001
Model A5	5. Elementary Geometry	10032	9977	72	9	< .001
Model A6	6. Trigonometry	8636	8582	72	9	< .001
Model A7	7. Higher Functions	10207	10142	83	9	< .001
Model A8	8. Differential Calculus	9333	9240	112	10	< .001
Model A9	9. Integral Calculus	8329	8208	139	9	< .001
Model A10	10. Linear Equation Systems	8571	8536	55	10	< .001
Model A11	11. Vectors and Analytical Geometry	11334	11146	212	12	< .001
Model B	All	100856	99586	1502	116	< .001

1.4. Partial Credit Scoring

Initial partial credit scoring (**Partial Credit Scoring Version 1; PCS1**) was done by counting each discrete text entry field as a separate response for all text entry problems. Each multiple-choice item for which respondents could choose only one response was counted as a single point. For each multiple-choice item, where the participants could choose one or more answers, the math problem was worth a number of points equal to the answer options; i.e., each correct response or correct rejection was worth one point unless the respondent did not choose any options (i.e., skipped the math problem). In this case, they earned 0 points. Otherwise, the total points for the problem were summed for each question part. If a problem contained multiple question types, all parts were summed based on the rules for each question part (e.g., multiple-choice vs. single-choice).

Partial credit scoring version 2 (PCS2) used **PCS1** as a base but combined text-entry answers that reflected a single response split across multiple blanks (e.g., if two blanks were used to reflect the numerator and the denominator of a single fraction, these two blanks were counted as a single answer, even though a fraction requires two responses for the numerator and the denominator, respectively; if two or more blanks were used to represent the digits of a vector, all blanks were counted as a single answer that describes the vector). Further, problem GR12 had too many possible points relative to other problems (12 text-entry fields in total). It was rescaled to include only 3 points, i.e., one point for 100% correct responses on each of the three question parts shown in **Section 3**.

Partial credit scoring version 3 (PCS3) used **PCS2** as a base but combined multiple-choice answer options that were mutually exclusive as a single answer (e.g., if one answer choice refers to a data point as a “local maximum,” and the other as a “local minimum,” these two answer options are mutually exclusive); participants were awarded only one point if both answers are correct (i.e., only one of these answers was chosen as correct) and zero points otherwise. After an initial screening of two coders, expert ratings were used to determine which answers were mutually exclusive (**87%** agreement between the expert rater and problems identified by the coders). Additionally, math problems requiring a specific number of responses (e.g., a matched pair) were also altered to reflect the specific number of responses required (e.g., if a matched pair is required, that pair is a single response; if only 3 responses are allowed, only 3 points can be awarded in total).

Partial credit scoring version 4 (PCS4) used **PCS3** as a base, but some math problems and problem parts were removed after initial analyses due to poor psychometric properties and after a review by math content specialists. The removed and altered math problems are listed in **Section 4**. Descriptions of the removed and altered problems, along with a rationale for each change, are listed in **Appendix 8.1**.

We use PCS4 as the basis for this report on item functioning because it is most plausible and produces the best model fit. All math problems that were changed based on **PCS2**, **PCS3**, and **PCS4** are listed in **Table 5**.

Table 5. List of Problems With Changes in the Different Partial Credit Scoring Versions

Problem ID	Subscale	Changed in	Old # Points	New # Points	Comments
GR9	1. Basic Arithmetic Operations	PCS4	5	4	
GR10	1. Basic Arithmetic Operations	PCS2	5	4	
GR11	1. Basic Arithmetic Operations	PCS4	1	0	
GR12	1. Basic Arithmetic Operations	PCS2	12	3	
P1	2. Exponents, Roots, Logarithms	PCS2	5	2	
TG5	3. Terms and Equations	PCS2	5	3	
TG9	3. Terms and Equations	PCS3	3	1	
EF5	4. Elementary Functions	PCS2	4	2	
EF6	4. Elementary Functions	PCS2	2	1	
G10	5. Elementary Geometry	PCS2	4/1	1	The problem was programmed as a single-choice item in some data collections and a multiple-choice item in others. It was scored as a single-choice item in all analyses.
HF3	7. Higher Functions	PCS3	3	3	A special rule was used in grading this problem. If participants did not enter the correct solution in the required format, 1 point was deducted.
D7	8. Differential Calculus	PCS3	4	2	
D11	8. Differential Calculus	PCS3	4	3	
I1	9. Integral Calculus	PCS3	4	2	
I8	9. Integral Calculus	PCS3	5	3	
I8	9. Integral Calculus	PCS4	3	1	
L2	10. Linear Equation Systems	PCS3	3/4	1	The problem was changed after the pilot study; see different versions in Section 4.
L4	10. Linear Equation Systems	PCS3	6	3	
L5	10. Linear Equation Systems	PCS2	2	1	
L12	10. Linear Equation Systems	PCS4	1	0	
V1	11. Vectors and Analytical Geometry	PCS2	2	1	
V4	11. Vectors and Analytical Geometry	PCS3	4	1	
V5	11. Vectors and Analytical Geometry	PCS2	3/2	1	The problem was changed after the pilot study; see different versions in Section 4.
V7	11. Vectors and Analytical Geometry	PCS2	3	1	
V8	11. Vectors and Analytical Geometry	PCS2	3	2	
V11	11. Vectors and Analytical Geometry	PCS3	4	2	

1.5. Sample Description

Participants came from an initial sample of 4,423 university or university-of-applied-sciences students enrolled in study programs in North Rhine-Westphalia. Data collections took place in 36 courses (e.g., math courses, preparatory math courses, other quantitative courses) and was supervised by research assistants. Due to the COVID-19 pandemic, most students took the test online during class time but parts of the sample completed a pen-and-paper version of the test. Of the initial 4,423 participations, 4 cases were out of sample (e.g., an instructor), 660 cases had insufficient data (i.e., dropped out prior to reaching the math problems), 160 cases were duplicates (i.e., the same student took the test multiple times or attended multiple courses), and 386 participants did not answer any math problems correctly so that their data could not be fitted to any IRT models. This data cleaning resulted in a **final sample of 3,213 participants**. The demographic background of the final sample is summarized in **Table 6**.

Table 6. Demographic Characteristics of Participants in the Final Sample

Category	Percentage
<u>Gender</u>	
Male	66.0%
Female	32.4%
Nonbinary	0.8%
No response	0.9%
<u>Age</u>	
≤17	2.1%
18-21	78.1%
22-25	14.0%
26-30	3.9%
>30	1.3%
No response	0.5%
<u>Primary language at home</u>	
German as primary language	75.1%
Other language as primary language	24.2%
No response	0.8%
<u>Country of secondary school completion</u>	
Completed secondary school in Germany	89.4%
Completed secondary school abroad	10.0%
No response	0.6%
<u>Math attended as an advanced course in high school ("Leistungskurs")</u>	
Math was taken as an advanced course	54.9%
Math was not taken as an advanced course	35.9%
Math was not available as an advanced course	7.5%
No response	1.7%
<u>Type of secondary school</u>	
Gymnasium	73.9%
Comprehensive school ("Gesamtschule")	10.8%
Other type	13.3%
No response	2.0%
<u>Type of postsecondary institution</u>	
University	74.6%
University of applied sciences ("Fachhochschule")	25.4%
<u>Math preparatory course before the start of postsecondary education</u>	
Math preparatory course taken	52.6%
Math preparatory course not taken	46.0%
No response	1.4%
<u>Test modality</u>	
Online	71.0%
Pen-and-paper	29.0%
<u>Semester</u>	
1. Semester	77.7%
2. Semester	9.5%
3. Semester	3.9%
4. Semester	2.5%
5. Semester	1.0%
6. Semester	1.1%
> 6. Semester	2.3%
No response	2.1%
<u>Area of major^a</u>	
Economics (W irtschaftswissenschaften)	14.9%
Computer science (I nformatik)	32.6%
Natural sciences (N aturwissenschaften)	31.0%
Technology (T echnik einschl. Ingenieurwissenschaften)	52.8%
Other/No response	2.6%

Note. Percentages may not add to 100% due to rounding.

^a Percentages do not add up to 100% due to multidisciplinary majors covering multiple areas.

2. Reliability Estimates and Basic Information for the Overall Test

This section includes information pertinent to the overall performance of all IRT models tested (i.e., **Models A1-A11, B, C, and D**). See **Section 1.3** for the specification of these models and **Section 1.4** for details on the alternate partial credit scoring versions.

2.1. Marginal Estimates of Reliability Based on Weighted Likelihood Estimates (WLE) of Ability

The weighted likelihood estimate of ability (WLE) reliability is a single-value estimate of the reliability of the test (i.e., a marginal reliability estimate). It can be interpreted similarly to classic measures of reliability (Penfield & Bergeron, 2005; Shu & Schwarz, 2014) and is calculated using Warm's (1989) method. Similar to reliability in classical test theory, marginal estimates above 0.7 are desirable. However, values above 0.5 may still be acceptable for individual subscales, especially given their shorter lengths (compare to Yilmaz, 2019's interpretation of reliability in GPCM, and see Taber, 2018, regarding the interpretation of reliability measures in classical test theory). However, unlike classical test theory, it is important to note that the reliability in IRT models varies by participant ability (see Green et al., 1984), which is discussed in greater detail in **Section 2.2**.

Tables 7, 8, 9, and 10 show a general overview of the marginal reliability of the test for **Models A1-A11, B, C, and D**, and for **PCS1, PCS2, PCS3, and PCS4**. Also shown are some other basic features of each model, including the number of responses, Akaike information criterion (AIC), Bayesian information criterion (BIC), and the number of parameters for each model. Smaller AIC and BIC values generally indicate better model fit.

Table 7. An Overview of the Model Characteristics for Partial Credit Scoring Version 1 (PCS1)

Model	Subscale(s)	WLE Reliability	# Cases	AIC	BIC	# Parameters
Model A1	1. Basic Arithmetic Operations	.502	731	12379	12609	50
Model A2	2. Exponents, Roots, Logarithms	.564	738	9324	9472	32
Model A3	3. Terms and Equations	.601	696	8968	9109	31
Model A4	4. Elementary Functions	.677	698	9307	9452	32
Model A5	5. Elementary Geometry	.615	718	9977	10133	34
Model A6	6. Trigonometry	.638	687	8582	8713	29
Model A7	7. Higher Functions	.772	692	10142	10301	35
Model A8	8. Differential Calculus	.581	695	9764	9909	32
Model A9	9. Integral Calculus	.680	692	9634	9788	34
Model A10	10. Linear Equation Systems	.621	683	10621	10797	39
Model A11	11. Vectors and Analytical Geometry	.758	676	12898	13141	54
Model B	All	.810	3213	109380	111822	402
Model C	All	.824	3213	111168	113549	392
Model D	All	NA	3213	108960	111736	457
Model D	1. Basic Arithmetic Operations	.520	731	NA	NA	NA
Model D	2. Exponents, Roots, Logarithms	.541	738	NA	NA	NA
Model D	3. Terms and Equations	.595	696	NA	NA	NA
Model D	4. Elementary Functions	.679	698	NA	NA	NA
Model D	5. Elementary Geometry	.614	718	NA	NA	NA
Model D	6. Trigonometry	.641	687	NA	NA	NA
Model D	7. Higher Functions	.772	692	NA	NA	NA
Model D	8. Differential Calculus	.585	695	NA	NA	NA
Model D	9. Integral Calculus	.678	692	NA	NA	NA
Model D	10. Linear Equation Systems	.621	683	NA	NA	NA
Model D	11. Vectors and Analytical Geometry	.761	676	NA	NA	NA

Table 8. An Overview of the Model Characteristics for Partial Credit Scoring Version 2 (PCS2)

Model	Subscale(s)	WLE Reliability	# Cases	AIC	BIC	# Parameters
Model A1	1. Basic Arithmetic Operations	.556	731	11419	11603	40
Model A2	2. Exponents, Roots, Logarithms	.570	738	8795	8928	29
Model A3	3. Terms and Equations	.602	696	8709	8841	29
Model A4	4. Elementary Functions	.682	698	8769	8901	29
Model A5	5. Elementary Geometry	.615	718	9977	10133	34
Model A6	6. Trigonometry	.638	687	8582	8713	29
Model A7	7. Higher Functions	.772	692	10142	10301	35
Model A8	8. Differential Calculus	.581	695	9764	9909	32
Model A9	9. Integral Calculus	.680	692	9634	9788	34
Model A10	10. Linear Equation Systems	.622	683	10510	10682	38
Model A11	11. Vectors and Analytical Geometry	.757	676	12059	12281	49
Model B	All	.812	3213	106130	108426	378
Model C	All	.822	3213	107394	109629	368
Model D	All	NA	3213	105713	108343	433
Model D	1. Basic Arithmetic Operations	.573	731	NA	NA	NA
Model D	2. Exponents, Roots, Logarithms	.570	738	NA	NA	NA
Model D	3. Terms and Equations	.596	696	NA	NA	NA
Model D	4. Elementary Functions	.684	698	NA	NA	NA
Model D	5. Elementary Geometry	.614	718	NA	NA	NA
Model D	6. Trigonometry	.644	687	NA	NA	NA
Model D	7. Higher Functions	.772	692	NA	NA	NA
Model D	8. Differential Calculus	.582	695	NA	NA	NA
Model D	9. Integral Calculus	.678	692	NA	NA	NA
Model D	10. Linear Equation Systems	.623	683	NA	NA	NA
Model D	11. Vectors and Analytical Geometry	.760	676	NA	NA	NA

Table 9. An Overview of the Model Characteristics for Partial Credit Scoring Version 3 (PCS3)

Model	Subscale(s)	WLE Reliability	# Cases	AIC	BIC	# Parameters
Model A1	1. Basic Arithmetic Operations	.556	731	11419	11603	40
Model A2	2. Exponents, Roots, Logarithms	.570	738	8795	8928	29
Model A3	3. Terms and Equations	.599	696	8129	8252	27
Model A4	4. Elementary Functions	.682	698	8769	8901	29
Model A5	5. Elementary Geometry	.615	718	9977	10133	34
Model A6	6. Trigonometry	.638	687	8582	8713	29
Model A7	7. Higher Functions	.772	692	10142	10301	35
Model A8	8. Differential Calculus	.584	695	9240	9372	29
Model A9	9. Integral Calculus	.694	692	8931	9067	30
Model A10	10. Linear Equation Systems	.632	683	9275	9420	32
Model A11	11. Vectors and Analytical Geometry	.746	676	11146	11345	44
Model B	All	.814	3213	102099	104274	358
Model C	All	.823	3213	102998	105112	348
Model D	All	NA	3213	101722	104231	413
Model D	1. Basic Arithmetic Operations	.574	731	NA	NA	NA
Model D	2. Exponents, Roots, Logarithms	.570	738	NA	NA	NA
Model D	3. Terms and Equations	.594	696	NA	NA	NA
Model D	4. Elementary Functions	.685	698	NA	NA	NA
Model D	5. Elementary Geometry	.614	718	NA	NA	NA
Model D	6. Trigonometry	.644	687	NA	NA	NA
Model D	7. Higher Functions	.772	692	NA	NA	NA
Model D	8. Differential Calculus	.584	695	NA	NA	NA
Model D	9. Integral Calculus	.696	692	NA	NA	NA
Model D	10. Linear Equation Systems	.635	683	NA	NA	NA
Model D	11. Vectors and Analytical Geometry	.750	676	NA	NA	NA

Table 10. An Overview of the Model Characteristics for Partial Credit Scoring Version 4 (PCS4)

Model	Subscale(s)	WLE Reliability	# Cases	AIC	BIC	# Parameters
Model A1	1. Basic Arithmetic Operations	.544	731	10410	10580	37
Model A2	2. Exponents, Roots, Logarithms	.570	738	8795	8928	29
Model A3	3. Terms and Equations	.599	696	8129	8252	27
Model A4	4. Elementary Functions	.682	698	8769	8901	29
Model A5	5. Elementary Geometry	.615	718	9977	10133	34
Model A6	6. Trigonometry	.638	687	8582	8713	29
Model A7	7. Higher Functions	.772	692	10142	10301	35
Model A8	8. Differential Calculus	.584	695	9240	9372	29
Model A9	9. Integral Calculus	.678	692	8208	8335	28
Model A10	10. Linear Equation Systems	.628	683	8536	8672	30
Model A11	11. Vectors and Analytical Geometry	.746	676	11146	11345	44
Model B	All	.814	3213	99586	101718	351
Model C	All	.822	3213	100450	102521	341
Model D	All	NA	3213	99230	101697	406
Model D	1. Basic Arithmetic Operations	.561	731	NA	NA	NA
Model D	2. Exponents, Roots, Logarithms	.571	738	NA	NA	NA
Model D	3. Terms and Equations	.594	696	NA	NA	NA
Model D	4. Elementary Functions	.685	698	NA	NA	NA
Model D	5. Elementary Geometry	.614	718	NA	NA	NA
Model D	6. Trigonometry	.645	687	NA	NA	NA
Model D	7. Higher Functions	.772	692	NA	NA	NA
Model D	8. Differential Calculus	.584	695	NA	NA	NA
Model D	9. Integral Calculus	.675	692	NA	NA	NA
Model D	10. Linear Equation Systems	.631	683	NA	NA	NA
Model D	11. Vectors and Analytical Geometry	.749	676	NA	NA	NA

2.2. Test Information Function

The same test can be more or less informative and reliable for individuals with different ability levels. For instance, the test may be highly informative for individuals with below average-to-average ability who can reliably identify potential knowledge gaps but less informative for individuals with very high ability who may be able to solve nearly all math problems and thus gain very little insight into their level of ability compared to other high-achieving individuals. The test information curve shows how informative and reliable a given test is for different ability levels. The test information function shows the amount of diagnostic information that can be gained from different math problems depending on the ability level of the responder. Each problem has its own problem information curve, defined by the function

$$I_{problem} = \sum_{j=0}^{c_i-1} I_{ij} (Var),$$

where, I_{ij} is a variance parameter reflecting the ratio of the unstandardized factor loading to the error variance, for a specific problem (i) and response category (j). Thus, $I_{problem}$ shows the information provided by that problem at different levels of θ . When this problem-specific information is summed across all math problems of the test, i.e.,

$$I_{test} = \sum I_{problem},$$

we obtain an information curve reflecting the amount of diagnostic information available across all math problems on the test. The utility of math problems in providing diagnostic information depends on how well the problem's difficulty level matches the responder's ability. Math problems targeted at a higher or a lower ability than a given responder's ability level provide less information for that responder because they are either very likely or very unlikely to respond correctly. The test information is linked to its reliability, where:

$$Reliability = \frac{1}{I + 1}$$

Accordingly, when the test provides at least 4 units of information (as shown by the area under the test information curve), the test's reliability exceeds 80% ($4/5 = 0.8$). When the test information is greater than 2.33 units, the reliability is above 70% ($2.33/3.33 = 0.7$).

Figures 2, 3, 4, and 5 show the test information curves for **Models A1-A11, B, C, and D**, respectively. Approximate ranges of θ values with reliability greater than 0.8 and 0.7 are shown in **Table 11**. As noted earlier, θ was standardized such that its mean is 0 (average ability) and its standard deviation is 1 (i.e., a θ of 1 means that the estimated ability is at one standard deviation above the mean, and a θ of 2 means that the estimated ability is at two standard deviations above the mean).

Figure 2. Test Information Curves for Models A1-A11

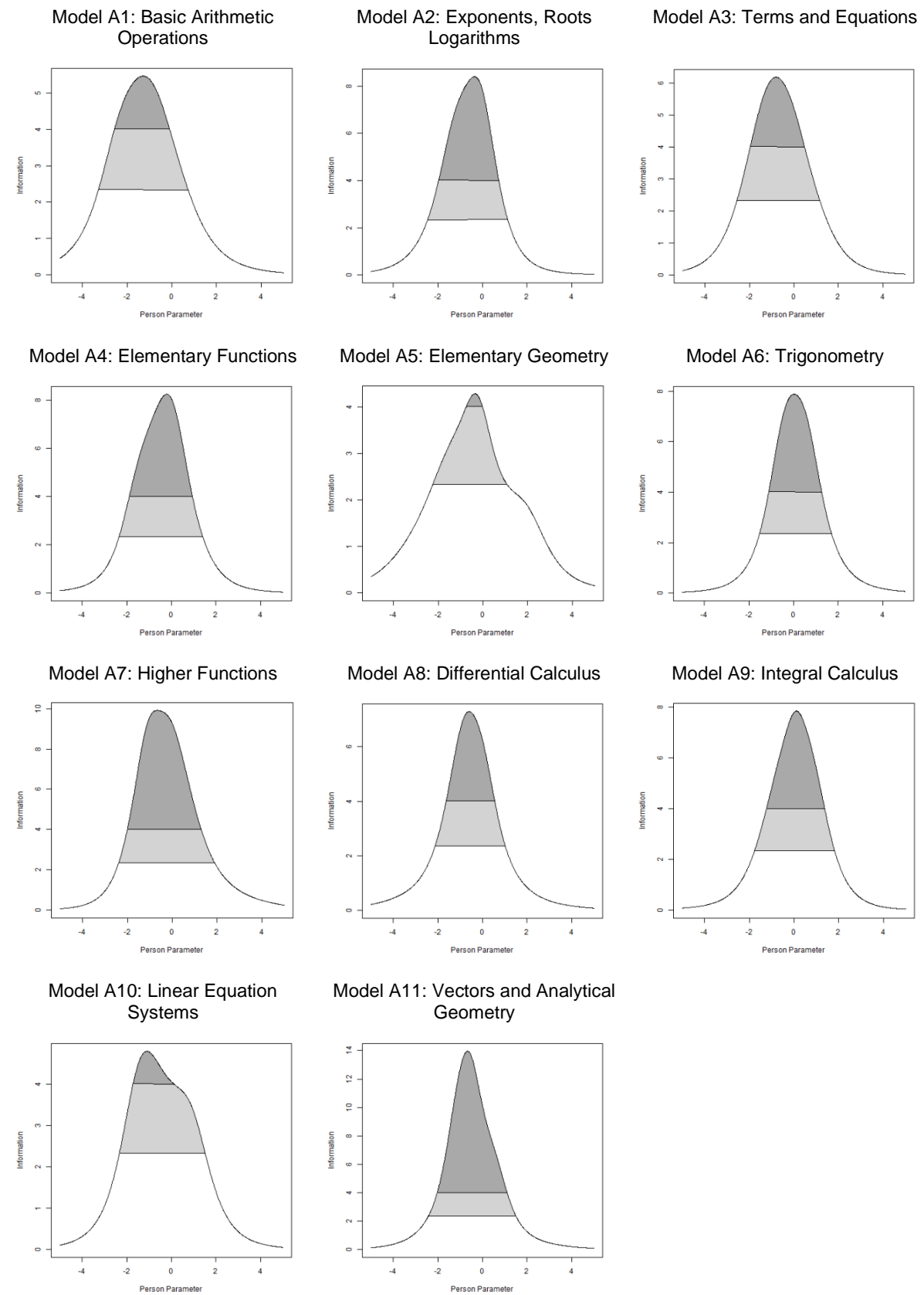

Note. The x-axis shows the person parameter (θ), and the y-axis shows how much information is available at each level of θ . Regions of the plot where the reliability ($\frac{1}{I+1}$) is over 80% are shaded in dark gray, and regions where it is over 70% are shaded in light gray.

Figure 3. Test Information Curve for Model B

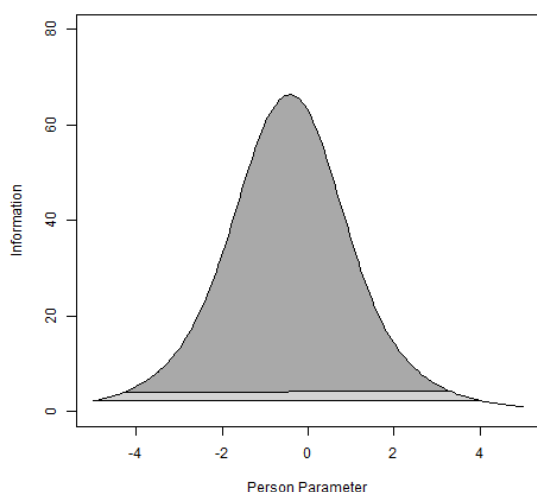

Note. The x-axis shows the person parameter (θ), and the y-axis shows how much information is available at each level of θ . Regions of the plot where the reliability ($\frac{1}{I+1}$) is over 80% are shaded in dark gray, and regions where it is over 70% are shaded in light gray.

Figure 4. Test Information Curve for Model C

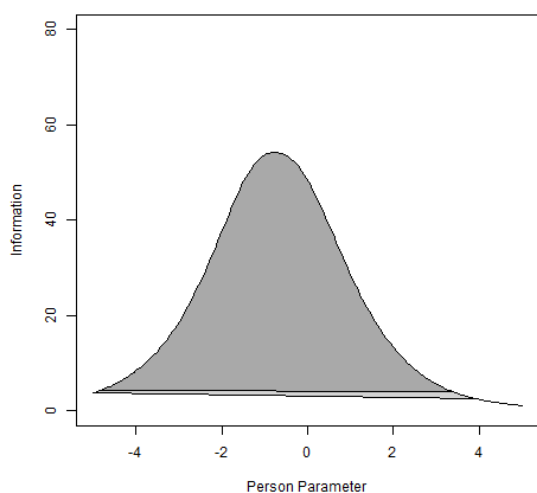

Note. The x-axis shows the person parameter (θ), and the y-axis shows how much information is available at each level of θ . Regions of the plot where the reliability ($\frac{1}{I+1}$) is over 80% are shaded in dark gray, and regions where it is over 70% are shaded in light gray.

Figure 5. Test Information Curves for Model D

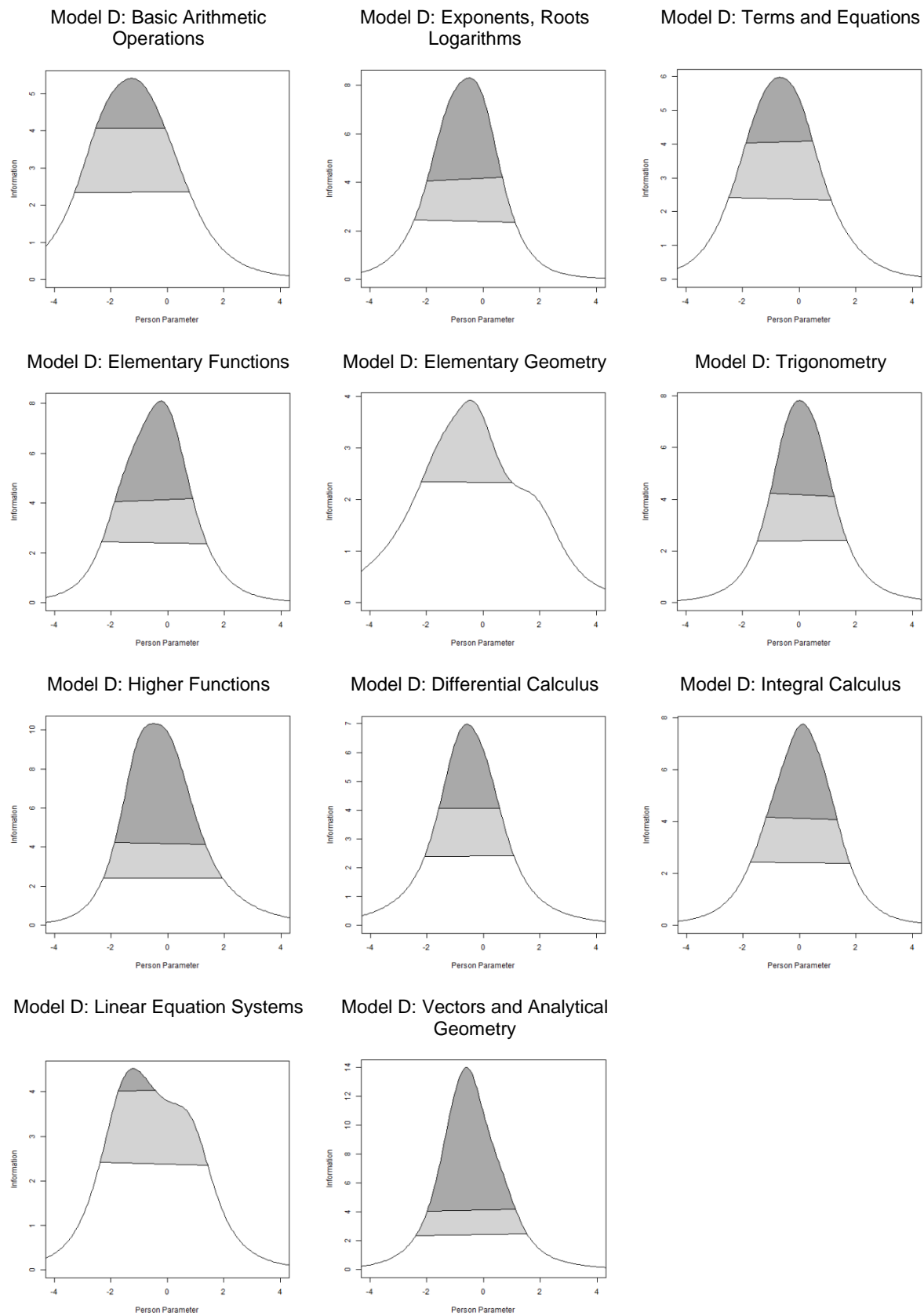

Note. The x-axis shows the person parameter (θ), and the y-axis shows how much information is available at each different level of θ . Regions of the plot where the reliability ($\frac{1}{I+1}$) is over 80% are shaded in dark gray, and regions where it is over 70% are shaded in light gray.

Table 11. Approximate Ranges of Reliable θ -Values for Each Subscale and Model

Model	Subscale(s)	Approximate θ Ranges ($M = 0, SD = 1$)	
		Reliability > 0.80	Reliability > 0.70
Model A1	1. Basic Arithmetic Operations	[-2.6, -0.1]	[-3.3, 0.7]
Model A2	2. Exponents, Roots, Logarithms	[-2.0, 0.7]	[-2.5, 1.1]
Model A3	3. Terms and Equations	[-2.0, 0.5]	[-2.6, 1.2]
Model A4	4. Elementary Functions	[-1.9, 0.9]	[-2.3, 1.4]
Model A5	5. Elementary Geometry	[-0.7, 0.0]	[-2.2, 1.1]
Model A6	6. Trigonometry	[-1.1, 1.3]	[-1.5, 1.7]
Model A7	7. Higher Functions	[-2.0, 1.3]	[-2.4, 1.9]
Model A8	8. Differential Calculus	[-1.6, 0.6]	[-2.1, 1.0]
Model A9	9. Integral Calculus	[-1.2, 1.4]	[-1.8, 1.8]
Model A10	10. Linear Equation Systems	[-1.7, 0.1]	[-2.3, 1.5]
Model A11	11. Vectors and Analytical Geometry	[-2.0, 1.1]	[-2.4, 1.5]
Model B	All	[-4.2, 3.3]	[-4.9, 4.0]
Model C	All	[-4.8, 3.4]	[-5.0, 4.0]
Model D	1. Basic Arithmetic Operations	[-2.5, -0.1]	[-3.3, 0.8]
Model D	2. Exponents, Roots, Logarithms	[-2.0, 0.7]	[-2.4, 1.1]
Model D	3. Terms and Equations	[-1.9, 0.5]	[-2.5, 1.1]
Model D	4. Elementary Functions	[-1.9, 0.9]	[-2.3, 1.4]
Model D	5. Elementary Geometry	\emptyset	[-2.2, 1.0]
Model D	6. Trigonometry	[-1.0, 1.2]	[-1.5, 1.7]
Model D	7. Higher Functions	[-1.9, 1.3]	[-2.3, 1.9]
Model D	8. Differential Calculus	[-1.6, 0.6]	[-2.1, 1.1]
Model D	9. Integral Calculus	[-1.2, 1.3]	[-1.7, 1.8]
Model D	10. Linear Equation Systems	[-1.7, -0.4]	[-2.4, 1.4]
Model D	11. Vectors and Analytical Geometry	[-2.0, 1.1]	[-2.4, 1.5]

Note. Ranges are approximated to one decimal place based on integration ranges of θ values to create plots. Integration is used to calculate the total amount of test information available for different intervals (or ranges) of θ . These ranges can be thought of as segments or bins of ability levels, and the integration is performed within these segments to generate data points for the test information curve.

It is evident that if one were to answer all questions of the test (see **Figures 3 and 4**), the reliability would be very high across all ability levels; however, some participants may only pick specific subscales, as reflected by the separate analyses for **Models A1-A11** and **Model D** (see **Figures 2 and 5**). Each subscale captures mathematical content that can vary in complexity and difficulty and thus has different

regions of high reliability. The test taker may wish to take subscales appropriate for their ability level to gain a more complete and reliable estimation of their ability level.

Overall, **the test is highly reliable for a broad range of ability levels**, which supports its broad applicability.

2.3. Residual Correlations (Q₃ Statistics)

We calculate residual correlations between items based on Yen's (1984) Q₃ statistic. Values above **0.20** and below **-0.20** are likely to indicate a violation of local independence (see Christensen et al., 2017). That is, individual math problems have notable residual associations that go beyond their shared underlying latent factor (theta). This may be because they capture similar content, have similar format, or share some other type of similarity beyond their associations with theta. Because Q₃ values may only be calculated for problems that occur together in the same booklet, we only show the Q₃ values within each subscale and only for **Models A1-A11** due to computational limitations (the R package used does not produce the required estimates in multidimensional models). Q₃ values are reported in the sections detailing each individual subscale.

2.4. Differential Item Functioning (DIF)

Problems were assessed for differential item functioning (DIF) across the seven comparison groups of: gender (male vs. female), primary language at home (German vs. other), attendance of math as an advanced course in high school (attended "Leistungskurs" vs. not attended or not available), participation in a preparatory math course prior to higher education (attended vs. not attended), type of institution (university vs. university of applied sciences), test modality (online vs. pen-and-paper), and type of secondary school (whether students attended a Gymnasium vs. other secondary schools).

In traditional DIF analyses, anchor problems that are assumed to have no DIF are required; however, because of the multi-matrix design of our test, no math problems are available that were answered by every person. As a result, multiple anchor problems would be required to cover each test booklet and subscale. An alternative procedure was adapted from Suh and Cho (2014; also see Schnick-Vollmer et al., 2020, for an implementation example) that allowed for DIF testing without anchor problems.

First, omnibus tests were conducted that compared the model fits when separate alpha and beta parameters were calculated for each comparison group, compared to when both parameters were fixed across both groups. This test was corrected with a Bonferroni correction (117 items were tested across 7 comparison groups), resulting in an adjusted *p*-value of approximately .00006. If this test was significant, the problem was considered to have DIF and was further explored by a test of DIF in the alpha parameter and beta parameter with separate follow-up tests. In the first test, the fit of the problem with a fixed alpha parameter across both groups and a freed beta parameter was examined (i.e., a test for uniform DIF). In the second, both parameters were freed and tested against the model in which the alpha parameter was fixed (i.e., a test for nonuniform DIF). These tests were not corrected via Bonferroni so that the influence of each parameter on the overall χ^2 of the model comparison could be properly explored. DIF was tested using the individual **Models A1-A11** instead of **Model D** to reduce processing time.

Significant DIF indicated that the discrimination parameter (α), the difficulty parameter (β), or both differed significantly across the compared groups. In this case, the problem was more or less difficult based on group membership and/or was more or less discriminating based on group membership. A list of all problems with significant DIF is detailed in **Table 12**. The nature of the DIF is described in the item-specific psychometric analyses reported below (see **Section 3.3**). As shown in **Table 12**, most differences occurred for students' participation in advanced placement math courses and students' primary language. Both group variables imply somewhat different learning opportunities and self-selection processes.

Table 12. Problems With Differential Item Functioning (DIF)

Problem ID	Subscale	Gender	Primary Language	Math Taken as Advanced Course in School	School Type	Preparatory Course Taken	Type of Higher Education Institution	Test Modality
GR9	1. Basic Arithmetic Operations		α, β					
GR10	1. Basic Arithmetic Operations			α, β				
P8	2. Exponents, Roots, Logarithms		α, β					
TG2	3. Terms and Equations		α					
EF1	4. Elementary Functions				α			
EF7	4. Elementary Functions		α, β					
G3	5. Elementary Geometry			α, β				
TR3	6. Trigonometry			α, β				
TR7	6. Trigonometry		α, β					
HF4	7. Higher Functions			β				
D4	8. Differential Calculus					α, β		
I2	9. Integral Calculus			α, β			α	
L9	10. Linear Equation Systems		β					
V10	11. Vectors and Analytical Geometry			α, β				
V11	11. Vectors and Analytical Geometry		α, β					

Note. Only problems with DIF are listed. A blank square means there was no DIF for that group comparison. α indicates DIF in the discrimination parameter (α) between groups, and β indicates DIF in the difficulty parameter (β) between comparison groups.

2.5. Subscale Correlation Matrices

Model D allowed the 11 subscale-specific estimates of students’ abilities to covary. **Table 13** shows the correlation matrix for **Model D** across all subscales. The subscales that appeared together in the multi-matrix design are bolded (see **Section 1.2** on the multi-matrix design for details on which subscales appeared together). Correlations that are not bolded were estimated based on the multi-matrix design and booklet linkage, even though there was no overlap between these subscales in the booklets. Therefore, caveats regarding the interpretation of these non-bolded effect sizes apply. As shown in **Table 13**, the subscales are highly interrelated.

Table 13. Subscale Correlation Matrix of Ability Estimates (θ) for Model D

	1	2	3	4	5	6	7	8	9	10	11
1. Basic Arithmetic Operations	-										
2. Exponents, Roots, Logarithms	.69	-									
3. Terms and Equations	.82	.76	-								
4. Elementary Functions	.82	.87	.80	-							
5. Elementary Geometry	.61	.75	.77	.74	-						
6. Trigonometry	.68	.92	.80	.85	.77	-					
7. Higher Functions	.71	.90	.81	.91	.72	.88	-				
8. Differential Calculus	.76	.83	.87	.87	.77	.87	.87	-			
9. Integral Calculus	.75	.78	.88	.87	.85	.82	.85	.91	-		
10. Linear Equation Systems	.81	.92	.83	.93	.77	.90	.91	.86	.85	-	
11. Vectors and Analytical Geometry	.64	.73	.69	.87	.60	.71	.87	.81	.82	.78	-

Note. Bolded values indicate the two subscales appeared together in the same booklet(s).

2.6. Difficulty Ranges of Thurstonian Thresholds

Thurstonian thresholds were calculated to evaluate the difficulty of all math problems (also see **Section 3.3.2**). These indicate at what ability level (θ) a person has a 50% chance to earn a given number of points for the problem. In the case of a single-point problem, this is equal to the item parameter.

As seen in **Figures 6, 7, 8, and 9**, the range of thresholds is roughly normally distributed, with a peak between -1 and -0.5. This shows a good range of problem difficulties consistent with our findings based on the item information curves and reliabilities across different ability levels (see **Sections 2.1 and 2.2**).

Figure 6. Histograms of Difficulties for Models A1-A11

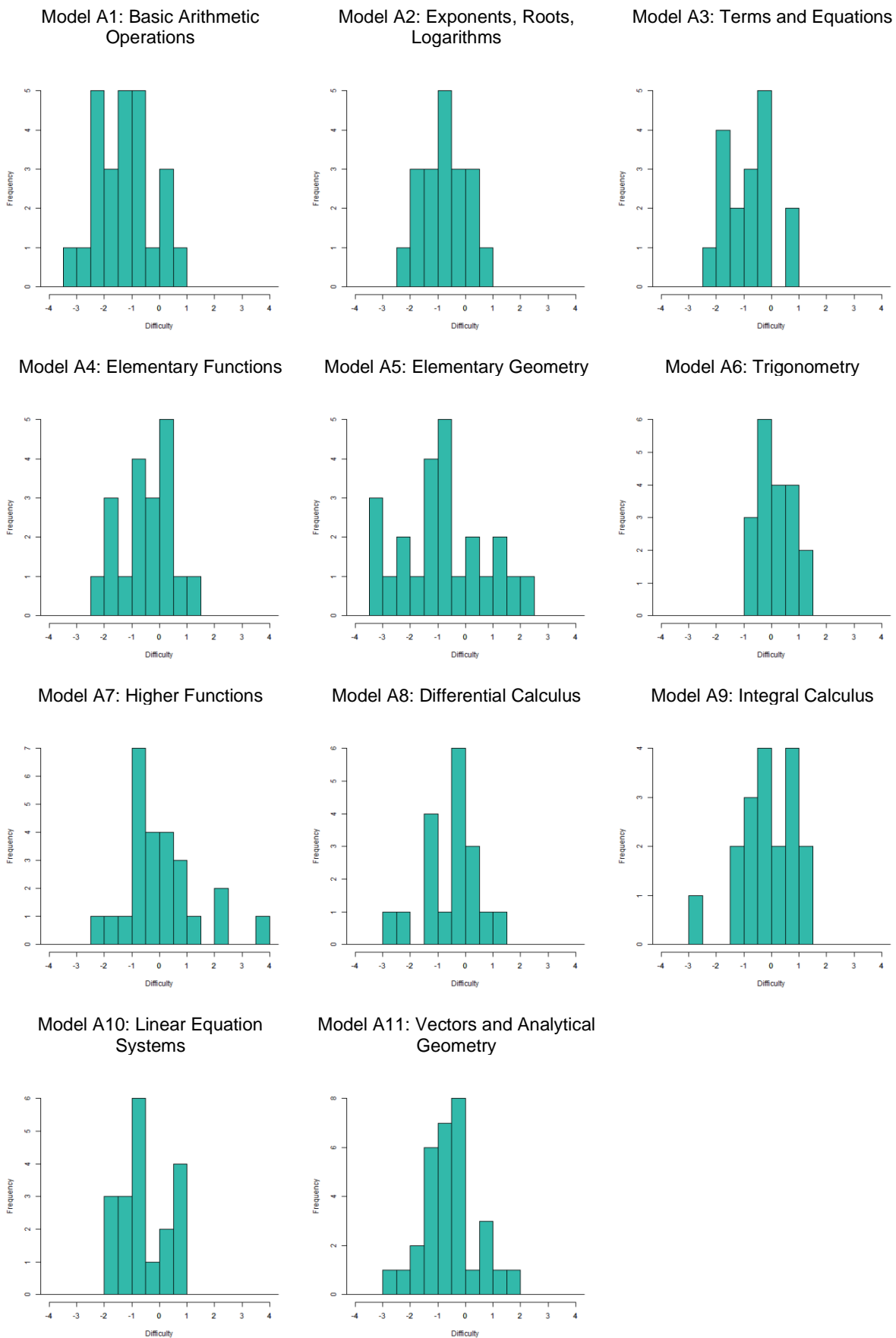

Note. Difficulties are all Thurstonian thresholds for the relevant subscale.

Figure 7. Histograms of Difficulties for Model B

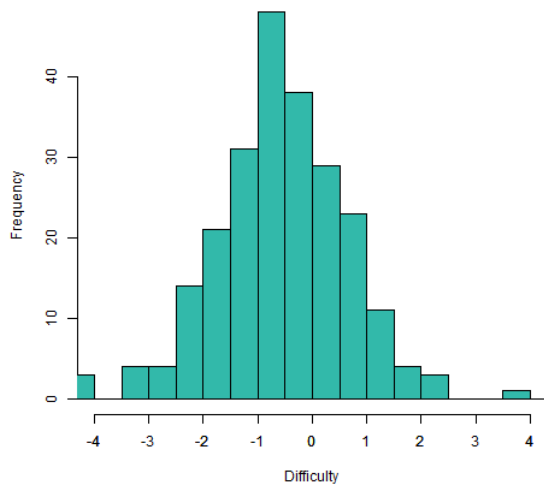

Note. Difficulties are all Thurstonian thresholds.

Figure 8. Histograms of Difficulties for Model C

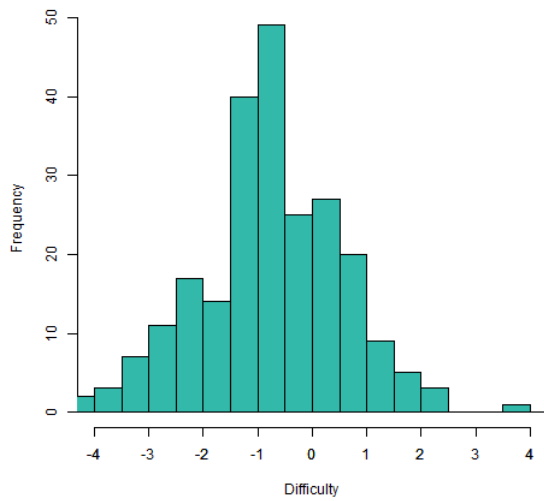

Note. Difficulties are all Thurstonian thresholds.

Figure 9. Histograms of Difficulties for Model D

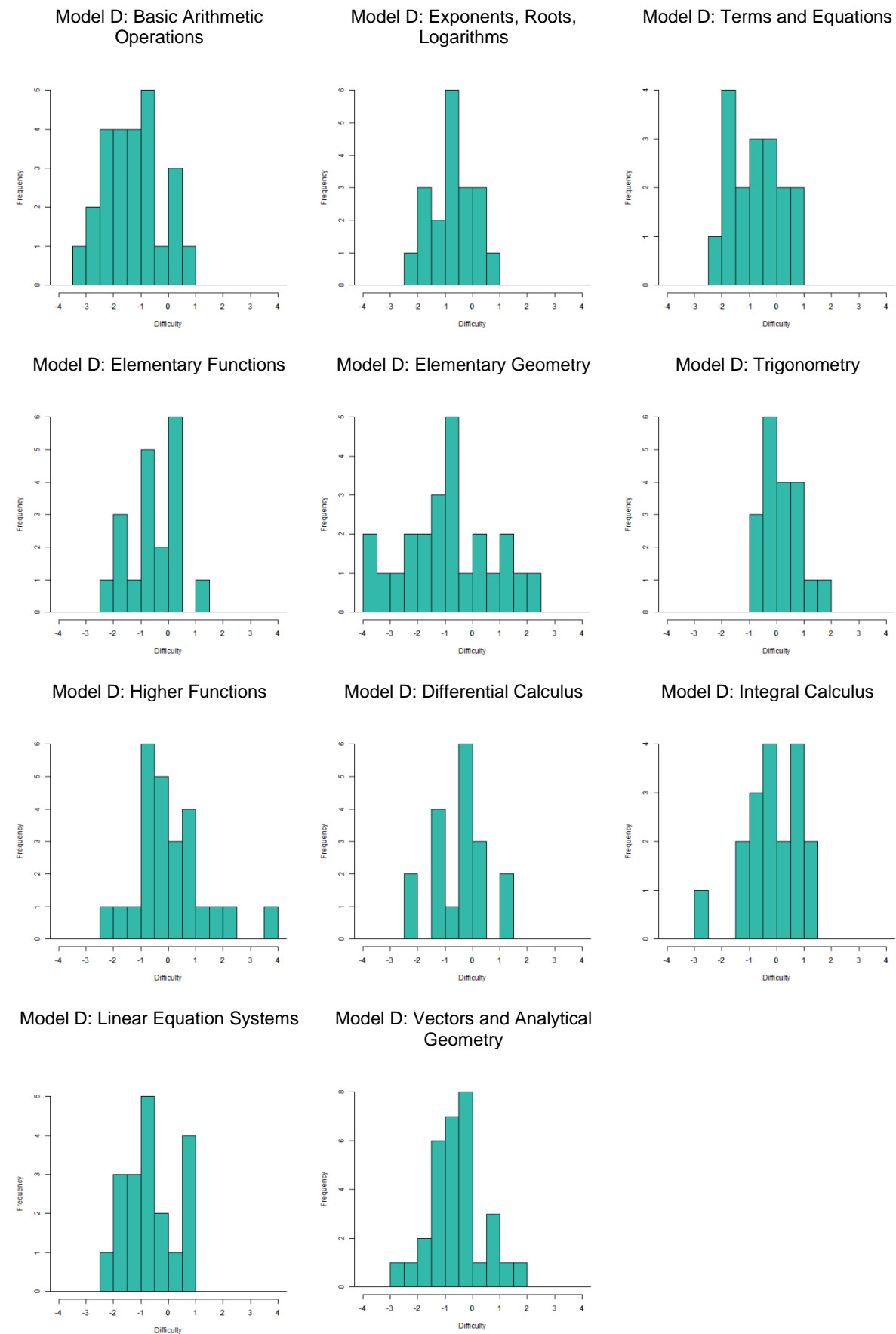

Note. Difficulties are all Thurstonian thresholds for the relevant subscale.

3. Overview of Psychometric Information Provided for Each Subscale and Item

This section describes the psychometric properties and additional statistics of the individual subscales and math problems that are reported in **Section 4**. Included are general information for each math problem, measures of item difficulty, and statistics describing how participants in our sample performed on each math problem.

3.1. Q₃ Statistics

At the beginning of each subscale, we include the Q₃ statistics, which reflect the residual correlations between different math problems on the subscale based on the relevant **Model A** (i.e., A1 to A11, see **Section 2.3**). Values with an absolute value greater than 0.2 may indicate local dependence between the two math problems (Christensen et al., 2017); i.e., residual associations between individual items that are not explained by the underlying latent ability factor theta.

3.2. Problem-Specific Information

A screenshot of each problem is given along with its unique item identifier, a table describing the correct response(s) to the problem, and how often those responses were given in the complete sample. The scoring rules applicable to the problem using **PCS4** are also described.

The response was treated as incorrect if a math problem was seen but not answered. If the problem was not reached, the response was treated as missing. If the problem answer was invalid (e.g., marking of multiple responses when only one was allowed in the pen-and-paper version of the test), the response was treated as incorrect. In the event that no responses were made on a multiple-choice question that allows for multiple responses, the entire problem was treated as skipped (i.e., all parts were graded as incorrect).

3.3. Psychometric Characteristics

Psychometric characteristics that are reported for each item and scale in Section 4 are listed below. Each table includes values for all **Models (A1-A11, B, C, and D)** using **PCS4**.

3.3.1. Discrimination

Two discrimination values are given. First, "correlation with participant ability" is the pairwise-complete correlation between performance on the item and ability level, as estimated by θ (i.e., a point-biserial correlation using WLE of θ). For **Models B, C, and D**, this is the overall θ , and for **Models A1-A11**, this is the corresponding value for the appropriate model. In general, the correlation to participant ability level should be above 0.20 (Bazaldua et al., 2017). Second, the α -parameter discrimination is the IRT value for the formula reported in **Section 1.3**. It is desirable to have an α -parameter above 1.00, with a value of 1.35 indicating good discrimination and values under 0.65 indicating that an item should be potentially revised. Problems with α -parameters under 0.35 may indicate that the math problem should be removed or completely rewritten (Ayala, 2009; Bichi & Talib, 2018). Content specialists need to evaluate the substantive fit of such items.

3.3.2. Difficulty

The difficulty is based on the item-parameter (sigma) for a given math problem and the point total on that problem. It represents the level of ability required to have a 50% chance of answering a specific item (question) correctly or, for a partial credit model, of earning a specific number of points (e.g., 4 out of 4). A participant whose ability parameter (θ) matches the Thurstonian threshold of a math problem's point total has a 50% chance of earning that many points on that math problem. More difficult problems will have a higher threshold and be correctly solved by fewer participants.

This report shows raw difficulty estimates without rescaling. As noted previously, the scale used for theta is $M = 0$ and $SD = 1$. Accordingly, a respondent whose ability is in the 50th percentile of our sample has a 50% chance of earning a point total with a difficulty value of 0. In subsequent tables showing difficulty, separate columns give values for **Models A1-A11, B, C, and D**. It is important to note that since **Model D** estimates the participants' math ability across all 11 subscales, we assume an average ability (i.e., 50th percentile) for each subscale for all **Model D** estimates to report the corresponding level of difficulty.

3.3.3. Cumulative Probability for an Average Participant

The cumulative probability of a responder of average ability in our sample (i.e., one with a mean-level ability) to earn a given number of points or better on the math problem is given for **Models A1-A11, B, C, and D**. For instance, a value of 50% would mean that the average participant would have a 50% chance of earning that number of points or better (e.g., at least 3 points out of 4). Again, it is important to note that since Model D estimates math ability across all 11 subscales, we assume an average ability (50th percentile) for each subscale for all **Model D** estimates of difficulty.

3.3.4. Frequencies of Attained Points

The percentage of participants in our sample who achieved a given point total on the math problem is also reported. Group-specific percentages describe participants in our sample who belong to the given group and achieved a specific point total on the math problem.

Unlike the cumulative percent values shown in the difficulty portion of the table, these values show **observed** percentages for each separate category. This differs from the predictive probability because it reflects observed distributions in our dataset. These values **do not** reflect predicted differences or differential item functioning between groups because each group may have a different average ability level (theta value).

We report the frequencies and percentages of responses earning each point total for each of the following groups:

- Gender (male or female): Participants self-reported their gender as female, male, or nonbinary. Because only a small percentage of the sample (0.8%) reported the category “nonbinary,” group-specific psychometric analyses were limited to the two categories “female” and “male.”
- Primary language at home (German or other): Participants self-reported whether their primary language at home was German or another language.
- Country of secondary school completion (Germany or abroad): Participants self-reported whether they have completed their secondary school education in Germany vs. outside of Germany.
- Type of secondary school (Gymnasium or other): Participants self-reported the type of secondary school where students received their higher education entrance certificate. For the group-specific psychometric analyses, students who attended comprehensive schools were combined with students who attended other school types and compared to students who received their certificate at a Gymnasium.
- Math taken as an advanced course in high school (yes or no): Participants self-reported whether they had attended math as a regular or an advanced course in secondary school. Participants with no advanced course available in their (home) state (7.5%) were excluded from group-specific psychometric analyses.
- Participation in math preparatory courses (yes or no): Participants self-reported whether they have participated (or are participating at the time of measurement) in a math preparatory course before starting their postsecondary education.
- Type of postsecondary institution (university or university of applied sciences): Students' type of postsecondary institution was recorded by a research assistant during the data collection.
- Test modality (online or pen-and-paper participation): A research assistant recorded the test modality during the data cleaning process.

3.3.5. Graphs

Graphs showing the item information curve, expected item performance, and probabilities of earning each possible point total are presented.

3.3.6. Differential Item Functioning (DIF)

If a problem shows DIF, it is described in detail, and the item performance curve for each group is detailed. See **Section 2.4** for details on DIF testing, including comparison groups.

4. Performance of Each Scale and Item

4.1. Basic Arithmetic Operations (Grundrechenarten und Zahlbereiche; GR)

Q₃ Statistics for Basic Arithmetic Operations

	GR1	GR2	GR3	GR4	GR5	GR6	GR7	GR8	GR9	GR10	GR12	GR13
GR1	-											
GR2	-.127	-										
GR3	-.066	-.074	-									
GR4	-.007	-.148	-.100	-								
GR5	-.086	-.115	-.181	-.027	-							
GR6	-.014	-.003	-.100	-.032	-.085	-						
GR7	-.143	-.068	-.079	.000	-.125	-.020	-					
GR8	-.089	-.082	-.098	-.089	-.070	-.108	.046	-				
GR9	-.079	-.163	-.180	-.236	-.030	-.005	-.149	.017	-			
GR10	-.106	-.261	-.295	-.163	-.174	-.132	-.152	-.043	-.060	-		
GR12	-.155	-.081	-.285	-.292	-.152	-.111	-.242	-.158	.100	-.012	-	
GR13	.001	-.109	-.128	.139	-.021	-.017	-.011	-.007	-.091	-.090	-.109	-

Note. Q₃ statistics above the critical absolute value of 0.20 are bolded. For details see **Section 3.1**.

4.1.1. Conversion of Fractions to Decimal Fractions (GR1)

Umwandeln von Brüchen in Dezimalbrüche

Welcher Dezimalzahl entsprechen die folgenden Brüche?

Wählen Sie jeweils die richtige Antwort.

a)

$$\frac{25}{9}$$

A 2,7̄ B 2,5̄ C 0,83̄ D 0,81̄

b)

$$\frac{5}{6}$$

A 2,7̄ B 2,5̄ C 0,83̄ D 0,81̄

Math Problem ID

GR1

Correct Answers and Answer Frequencies

Math Problem Part	Correct Answer	Number Correct Answers	Number Incorrect Answers ^a	Answer Frequencies			
				A	B	C	D
a)	blinded	blinded	blinded	blinded	blinded	blinded	blinded
b)	blinded	blinded	blinded	blinded	blinded	blinded	blinded

Note. Scoring (PCS4): Every correct response is worth one point (up to 2 points possible).

^a Includes cases, where the problem was seen but not answered.

Item Characteristics

Discrimination					
Measurement Type		Model A1	Model B	Model C	Model D
Correlation to participant ability (θ)		0.46	0.33	0.34	0.35
Discrimination Parameter (α)		0.94	0.66	0.92	0.84
Difficulty					
Measurement Type	Points	Model A1	Model B	Model C	Model D
Difficulty for participant of average ability level	2	-1.53	-1.89	-1.74	-1.63
	1	-2.48	-3.04	-3.02	-2.63
	0	NA	NA	NA	NA
Cumulative probability for participant of average ability level	2	85.9%	84.1%	86.8%	85.3%
	1	98.0%	96.8%	98.9%	97.6%
	0	100%	100%	100%	100%
Frequencies					
Groups	Points	Frequencies		Percent (%)	
Complete sample for this math problem (n = 579)	2	471		81.2%	
	1	78		13.4%	
	0	31		5.3%	
Female (n = 189)	2	148		78.3%	
	1	22		11.6%	
	0	19		10.1%	
Male (n = 380)	2	313		82.4%	
	1	56		14.7%	
	0	11		2.9%	
German as primary language at home (n = 431)	2	347		80.5%	
	1	60		13.9%	
	0	24		5.6%	
Other language as primary language at home (n = 142)	2	118		83.1%	
	1	18		12.7%	
	0	6		4.2%	
Secondary school completed in Germany (n = 510)	2	413		81.0%	
	1	70		13.7%	
	0	27		5.3%	
Secondary school completed abroad (n = 65)	2	54		83.1%	
	1	8		12.3%	
	0	3		4.6%	
Math not attended as advanced course in secondary school (n = 193)	2	153		79.3%	
	1	25		13.0%	
	0	15		7.8%	
Math attended as advanced course in secondary school (n = 323)	2	264		81.7%	
	1	48		14.9%	
	0	11		3.4%	

Frequencies			
Groups	Points	Frequencies	Percent (%)
No math preparatory course attended (n = 273)	2	222	81.3%
	1	31	11.4%
	0	20	7.3%
Math preparatory course attended (n = 298)	2	240	80.5%
	1	47	15.8%
	0	11	3.7%
University of applied sciences (n = 146)	2	116	79.5%
	1	15	10.3%
	0	15	10.3%
University (n = 434)	2	355	81.8%
	1	63	14.5%
	0	16	3.7%
Online Participation (n = 412)	2	342	83.0%
	1	52	12.6%
	0	18	4.4%
Pen-and-Paper Participation (n = 168)	2	129	76.8%
	1	26	15.5%
	0	13	7.7%
Attended Gymnasium (n = 420)	2	349	83.1%
	1	55	13.1%
	0	16	3.8%
Attended Other Secondary School (n = 141)	2	105	74.5%
	1	22	15.6%
	0	14	9.9%

Note. Due to missing values on demographics questions, frequencies within groups may not add up to the total number of responses.

Plots

All plots are generated from **Model A1**.

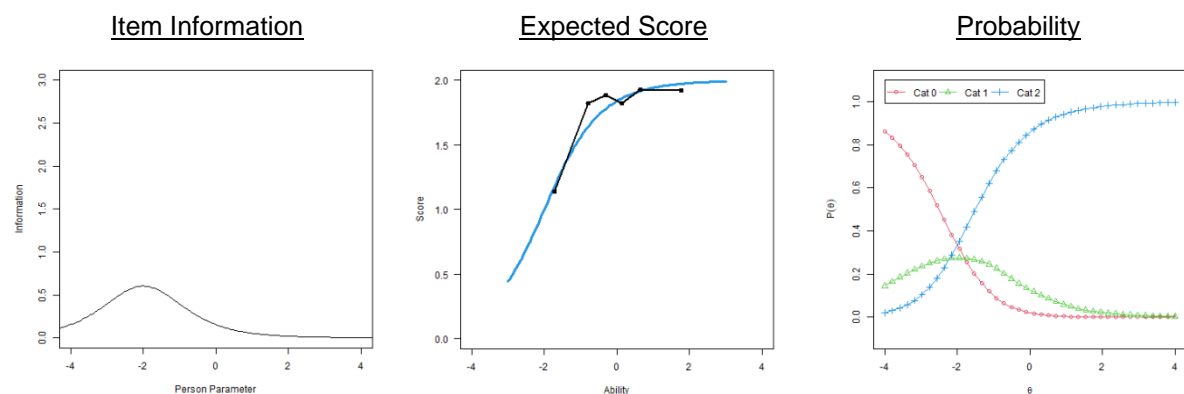

Note. The blue line represents expected performance, and the black line represents actual performance.

Note. Cat n = probability of receiving n points.

4.1.2. Fractions and Decimal Fractions (GR2)

Brüche und Dezimalbrüche

Geben Sie an welche Zahl jeweils größer ist.

Ergänzen Sie die freien Felder.

Beachten Sie: Nutzen Sie folgende Zeichen: < (kleiner als), > (größer als).

2,56	<input style="width: 100%; height: 20px;" type="text"/>	2,506
-7,45	<input style="width: 100%; height: 20px;" type="text"/>	-7,4
$\frac{2}{5}$	<input style="width: 100%; height: 20px;" type="text"/>	$\frac{7}{11}$

Math Problem ID

GR2

Correct Answers and Answer Frequencies

Blank	Correct Answer(s)	Number Correct Answers	Number Incorrect Answers
1	blinded	blinded	blinded
2	blinded	blinded	blinded
3	blinded	blinded	blinded

Note. Scoring (PCS4): Every correct response is worth one point (up to 3 points possible).

Item Characteristics

Discrimination					
Measurement Type		Model A1	Model B	Model C	Model D
Correlation to participant ability (θ)		0.53	0.43	0.45	0.45
Discrimination Parameter (α)		1.16	0.95	1.26	1.17
Difficulty					
Measurement Type	Points	Model A1	Model B	Model C	Model D
Difficulty for participant of average ability level	3	-1.28	-1.41	-1.35	-1.28
	2	-2.33	-2.44	-2.52	-2.29
	1	-2.98	-3.10	-3.72	-2.92
	0	NA	NA	NA	NA
Cumulative probability for participant of average ability level	3	84.2%	83.1%	86.7%	84.4%
	2	99.2%	98.7%	99.5%	99.2%
	1	100%	99.9%	100%	100%
	0	100%	100%	100%	100%

Frequencies			
Groups	Points	Frequencies	Percent (%)
Complete sample for this math problem (n = 582)	3	457	78.5%
	2	101	17.4%
	1	17	2.9%
	0	7	1.2%
Female (n = 189)	3	123	65.1%
	2	51	27.0%
	1	11	5.8%
	0	4	2.1%
Male (n = 381)	3	324	85.0%
	2	49	12.9%
	1	6	1.6%
	0	2	0.5%
German as primary language at home (n = 432)	3	344	79.6%
	2	76	17.6%
	1	8	1.9%
	0	4	0.9%
Other language as primary language at home (n = 142)	3	108	76.1%
	2	23	16.2%
	1	9	6.3%
	0	2	1.4%
Secondary school completed in Germany (n = 511)	3	399	78.1%
	2	92	18.0%
	1	14	2.7%
	0	6	1.2%
Secondary school completed abroad (n = 65)	3	53	81.5%
	2	9	13.8%
	1	3	4.6%
	0	0	0.0%
Math not attended as advanced course in secondary school (n = 194)	3	128	66.0%
	2	52	26.8%
	1	11	5.7%
	0	3	1.5%
Math attended as advanced course in secondary school (n = 323)	3	279	86.4%
	2	39	12.1%
	1	2	0.6%
	0	3	0.9%
No math preparatory course attended (n = 273)	3	210	76.9%
	2	46	16.8%
	1	11	4.0%
	0	6	2.2%
Math preparatory course attended (n = 299)	3	237	79.3%
	2	55	18.4%
	1	6	2.0%
	0	1	0.3%

Frequencies			
Groups	Points	Frequencies	Percent (%)
University of applied sciences (n = 147)	3	95	64.6%
	2	39	26.5%
	1	11	7.5%
	0	2	1.4%
University (n = 435)	3	362	83.2%
	2	62	14.3%
	1	6	1.4%
	0	5	1.1%
Online Participation (n = 414)	3	324	78.3%
	2	77	18.6%
	1	8	1.9%
	0	5	1.2%
Pen-and-Paper Participation (n = 168)	3	133	79.2%
	2	24	14.3%
	1	9	5.4%
	0	2	1.2%
Attended Gymnasium (n = 420)	3	347	82.6%
	2	63	15.0%
	1	7	1.7%
	0	3	0.7%
Attended Other Secondary School (n = 142)	3	94	66.2%
	2	35	24.6%
	1	10	7.0%
	0	3	2.1%

Note. Due to missing values on demographics questions, frequencies within groups may not add up to the total number of responses.

Plots

All plots are generated from **Model A1**.

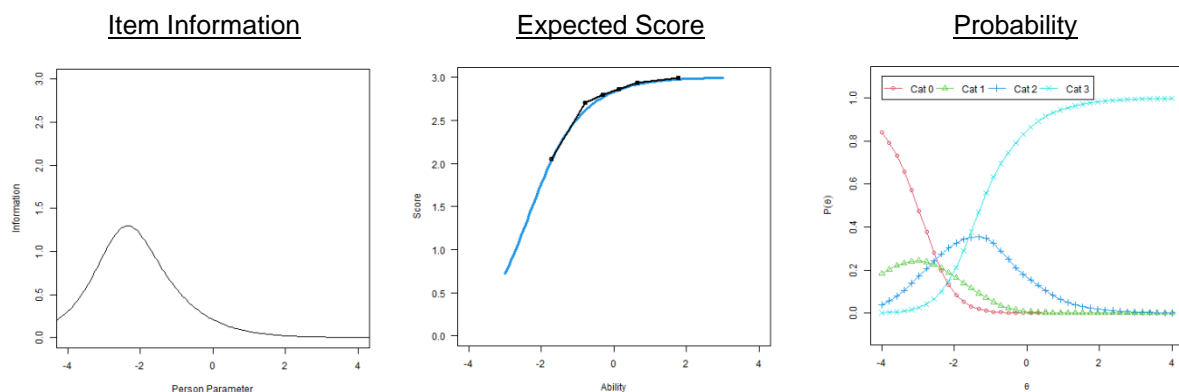

Note. The blue line represents expected performance, and the black line represents actual performance.

Note. Cat n = probability of receiving n points.

4.1.3. Fractions, Decimal Numbers, Percent (GR3)

Brüche, Dezimalzahlen, Prozent

Rechnen Sie um.

Ergänzen Sie die freien Felder.

Beachten Sie: Nutzen Sie zum Ausdruck von Brüchen das Zeichen / (Division).

In eine Dezimalzahl: $\frac{5}{8} =$

In Prozent: $\frac{4}{5} =$ %

In einen vollständig gekürzten Bruch: $0,6 =$

Math Problem ID

GR3

Correct Answers and Answer Frequencies

Blank	Correct Answer(s)	Number Correct Answers	Number Incorrect Answers
1	blinded	blinded	blinded
2	blinded	blinded	blinded
3	blinded	blinded	blinded

Note. Scoring (PCS4): Every correct response is worth one point (up to 3 points possible).

Item Characteristics

Discrimination					
Measurement Type		Model A1	Model B	Model C	Model D
Correlation to participant ability (θ)		0.68	0.59	0.59	0.59
Discrimination Parameter (α)		1.18	0.93	1.07	1.14
Difficulty					
Measurement Type	Points	Model A1	Model B	Model C	Model D
Difficulty for participant of average ability level	3	0.12	0.08	-0.06	0.08
	2	-1.09	-1.28	-1.35	-1.15
	1	-2.10	-2.41	-2.52	-2.18
	0	NA	NA	NA	NA
Cumulative probability for participant of average ability level	3	45.6%	47.7%	52.0%	47.1%
	2	88.0%	87.4%	90.6%	88.6%
	1	98.8%	98.4%	99.2%	98.8%
	0	100%	100%	100%	100%

Frequencies			
Groups	Points	Frequencies	Percent (%)
Complete sample for this math problem (n = 564)	3	255	45.2%
	2	189	33.5%
	1	85	15.1%
	0	35	6.2%
Female (n = 201)	3	69	34.3%
	2	74	36.8%
	1	40	19.9%
	0	18	9.0%
Male (n = 348)	3	174	50.0%
	2	115	33.0%
	1	45	12.9%
	0	14	4.0%
German as primary language at home (n = 407)	3	199	48.9%
	2	131	32.2%
	1	55	13.5%
	0	22	5.4%
Other language as primary language at home (n = 149)	3	51	34.2%
	2	58	38.9%
	1	30	20.1%
	0	10	6.7%
Secondary school completed in Germany (n = 492)	3	224	45.5%
	2	161	32.7%
	1	76	15.4%
	0	31	6.3%
Secondary school completed abroad (n = 67)	3	29	43.3%
	2	28	41.8%
	1	9	13.4%
	0	1	1.5%
Math not attended as advanced course in secondary school (n = 204)	3	57	27.9%
	2	78	38.2%
	1	47	23.0%
	0	22	10.8%
Math attended as advanced course in secondary school (n = 300)	3	170	56.7%
	2	91	30.3%
	1	30	10.0%
	0	9	3.0%
No math preparatory course attended (n = 250)	3	91	36.4%
	2	98	39.2%
	1	41	16.4%
	0	20	8.0%
Math preparatory course attended (n = 304)	3	159	52.3%
	2	88	28.9%
	1	44	14.5%
	0	13	4.3%

Frequencies			
Groups	Points	Frequencies	Percent (%)
University of applied sciences (n = 146)	3	50	34.2%
	2	51	34.9%
	1	33	22.6%
	0	12	8.2%
University (n = 418)	3	205	49.0%
	2	138	33.0%
	1	52	12.4%
	0	23	5.5%
Online Participation (n = 397)	3	188	47.4%
	2	132	33.2%
	1	56	14.1%
	0	21	5.3%
Pen-and-Paper Participation (n = 167)	3	67	40.1%
	2	57	34.1%
	1	29	17.4%
	0	14	8.4%
Attended Gymnasium (n = 402)	3	191	47.5%
	2	137	34.1%
	1	58	14.4%
	0	16	4.0%
Attended Other Secondary School (n = 143)	3	58	40.6%
	2	48	33.6%
	1	24	16.8%
	0	13	9.1%

Note. Due to missing values on demographics questions, frequencies within groups may not add up to the total number of responses.

Plots

All plots are generated from **Model A1**.

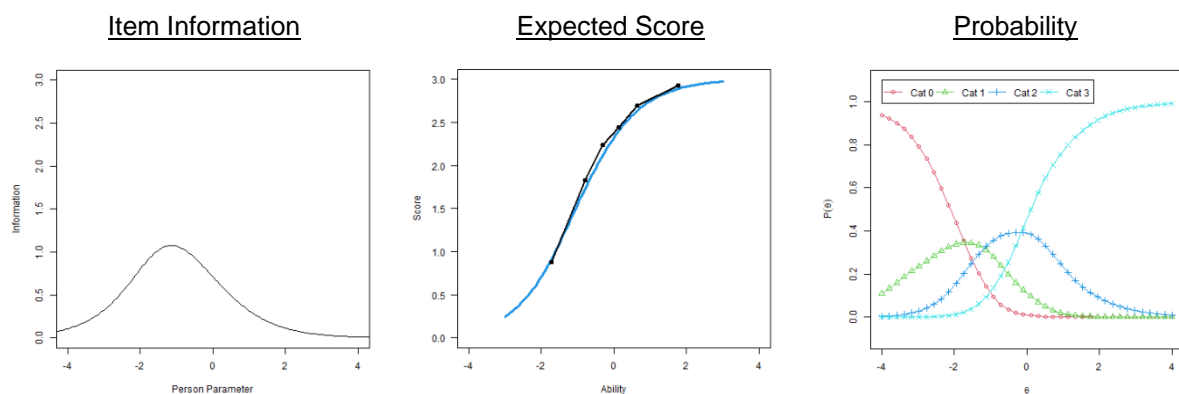

Note. The blue line represents expected performance, and the black line represents actual performance.

Note. Cat n = probability of receiving n points.

4.1.4. Decimal Fractions (GR4)

Dezimalbrüche

Berechnen Sie ohne Taschenrechner oder andere technische Hilfsmittel.
Geben Sie das Ergebnis als Dezimalzahl an.

Ergänzen Sie das freie Feld.

$3,2 \cdot 0,125 =$

Math Problem ID

GR4

Correct Answers and Answer Frequencies

Correct Answer(s)	Number Correct Answers	Number Incorrect Answers
blinded	blinded	blinded

Note. Scoring (PCS4): Every correct response is worth one point (up to 1 point possible).

Item Characteristics

Discrimination					
Measurement Type		Model A1	Model B	Model C	Model D
Correlation to participant ability (θ)		0.49	0.40	0.39	0.40
Discrimination Parameter (α)		1.26	0.97	0.98	1.14
Difficulty					
Measurement Type	Points	Model A1	Model B	Model C	Model D
Difficulty for participant of average ability level	1	-0.90	-1.16	-1.28	-1.01
	0	NA	NA	NA	NA
Cumulative probability for participant of average ability level	1	75.8%	75.4%	77.8%	76.0%
	0	100%	100%	100%	100%
Frequencies					
Groups	Points	Frequencies		Percent (%)	
Complete sample for this math problem (n = 563)	1	398		70.7%	
	0	165		29.3%	
Female (n = 200)	1	128		64.0%	
	0	72		36.0%	
Male (n = 348)	1	261		75.0%	
	0	87		25.0%	
German as primary language at home (n = 407)	1	295		72.5%	
	0	112		27.5%	

Frequencies			
Groups	Points	Frequencies	Percent (%)
Other language as primary language at home (n = 148)	1	97	65.5%
	0	51	34.5%
Secondary school completed in Germany (n = 491)	1	342	69.7%
	0	149	30.3%
Secondary school completed abroad (n = 67)	1	53	79.1%
	0	14	20.9%
Math not attended as advanced course in secondary school (n = 204)	1	132	64.7%
	0	72	35.3%
Math attended as advanced course in secondary school (n = 299)	1	225	75.3%
	0	74	24.7%
No math preparatory course attended (n = 249)	1	167	67.1%
	0	82	32.9%
Math preparatory course attended (n = 304)	1	224	73.7%
	0	80	26.3%
University of applied sciences (n = 146)	1	90	61.6%
	0	56	38.4%
University (n = 417)	1	308	73.9%
	0	109	26.1%
Online Participation (n = 396)	1	303	76.5%
	0	93	23.5%
Pen-and-Paper Participation (n = 167)	1	95	56.9%
	0	72	43.1%
Attended Gymnasium (n = 402)	1	298	74.1%
	0	104	25.9%
Attended Other Secondary School (n = 142)	1	89	62.7%
	0	53	37.3%

Note. Due to missing values on demographics questions, frequencies within groups may not add up to the total number of responses.

Plots

All plots are generated from **Model A1**.

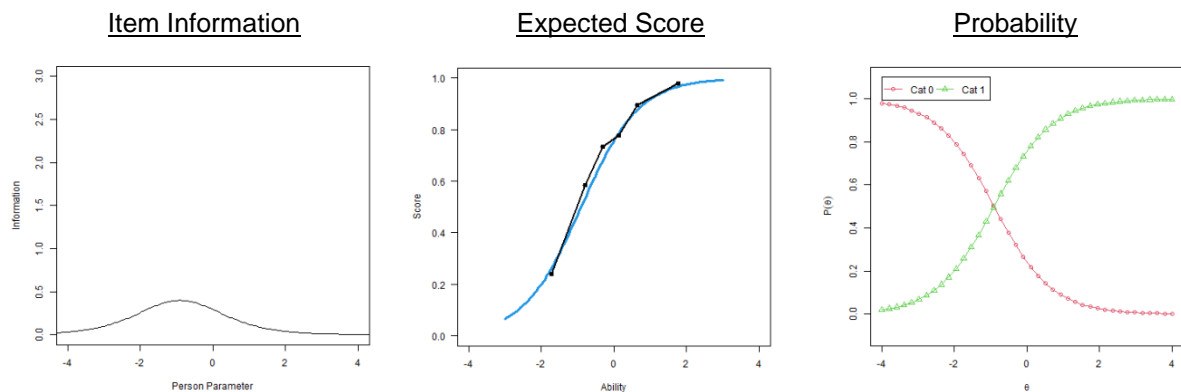

Note. The blue line represents expected performance, and the black line represents actual performance.

Note. Cat n = probability of receiving n points.

4.1.5. Calculations With Fractions (GR5)

Rechnen mit Brüchen

Berechnen Sie. Geben Sie das Ergebnis als vollständig gekürzten Bruch oder als Dezimalzahl an.

Ergänzen Sie das freie Feld.

$$\left(\frac{4}{3} - \frac{1}{2}\right) : \frac{-5}{12} = \square$$

Math Problem ID

GR5

Correct Answers and Answer Frequencies

Correct Answer(s)	Number Correct Answers	Number Incorrect Answers
blinded	blinded	blinded

Note. Scoring (PCS4): Every correct response is worth one point (up to 1 point possible).

Item Characteristics

Discrimination					
Measurement Type		Model A1	Model B	Model C	Model D
Correlation to participant ability (θ)		0.51	0.46	0.45	0.46
Discrimination Parameter (α)		1.20	1.10	1.10	1.20
Difficulty					
Measurement Type	Points	Model A1	Model B	Model C	Model D
Difficulty for participant of average ability level	1	-0.54	-0.65	-0.78	-0.59
	0	NA	NA	NA	NA
Cumulative probability for participant of average ability level	1	65.8%	67.1%	70.3%	67.0%
	0	100%	100%	100%	100%
Frequencies					
Groups	Points	Frequencies		Percent (%)	
Complete sample for this math problem (n = 560)	1	350		62.5%	
	0	210		37.5%	
Female (n = 199)	1	129		64.8%	
	0	70		35.2%	
Male (n = 346)	1	211		61.0%	
	0	135		39.0%	
German as primary language at home (n = 405)	1	259		64.0%	
	0	146		36.0%	

Frequencies			
Groups	Points	Frequencies	Percent (%)
Other language as primary language at home (n = 147)	1	88	59.9%
	0	59	40.1%
Secondary school completed in Germany (n = 488)	1	296	60.7%
	0	192	39.3%
Secondary school completed abroad (n = 67)	1	52	77.6%
	0	15	22.4%
Math not attended as advanced course in secondary school (n = 203)	1	102	50.2%
	0	101	49.8%
Math attended as advanced course in secondary school (n = 297)	1	206	69.4%
	0	91	30.6%
No math preparatory course attended (n = 247)	1	143	57.9%
	0	104	42.1%
Math preparatory course attended (n = 303)	1	201	66.3%
	0	102	33.7%
University of applied sciences (n = 146)	1	68	46.6%
	0	78	53.4%
University (n = 414)	1	282	68.1%
	0	132	31.9%
Online Participation (n = 394)	1	250	63.5%
	0	144	36.5%
Pen-and-Paper Participation (n = 166)	1	100	60.2%
	0	66	39.8%
Attended Gymnasium (n = 399)	1	259	64.9%
	0	140	35.1%
Attended Other Secondary School (n = 142)	1	81	57.0%
	0	61	43.0%

Note. Due to missing values on demographics questions, frequencies within groups may not add up to the total number of responses.

Plots

All plots are generated from **Model A1**.

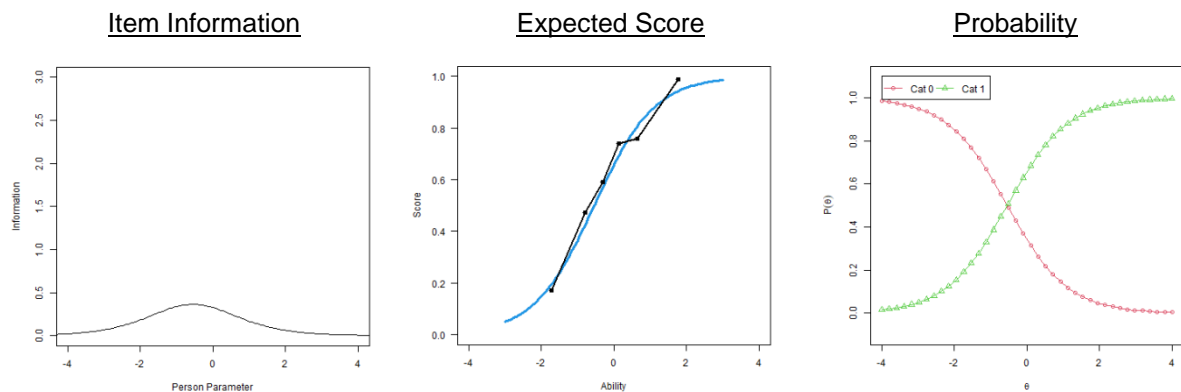

Note. The blue line represents expected performance, and the black line represents actual performance.

Note. Cat n = probability of receiving n points.

4.1.6. Comparing Sales, Calculations With Percent (GR6)

Angebote vergleichen, Prozentrechnung

Was ist günstiger: Angebot 1, in dem die Ware für 120€ abzüglich 20% angeboten wird, oder Angebot 2, dieselbe Ware für 97€?

Wählen Sie die richtige Antwort.

Angebot 1 A

Angebot 2 B

Beides kostet gleich viel C

Math Problem ID

GR6

Correct Answers and Answer Frequencies

Correct Answer	Number Correct Answers	Number Incorrect Answers ^a	Answer Frequencies		
			A	B	C
blinded	blinded	blinded	blinded	blinded	blinded

Note. Scoring (PCS4): Every correct response is worth one point (up to 1 point possible).

^a Includes cases, where the problem was seen but not answered.

Item Characteristics

Discrimination					
Measurement Type		Model	Model	Model	Model
		A1	B	C	D
Correlation to participant ability (θ)		0.33	0.25	0.25	0.26
Discrimination Parameter (α)		0.93	0.77	0.78	0.88
Difficulty					
Measurement Type	Points	Model	Model	Model	Model
		A1	B	C	D
Difficulty for participant of average ability level	1	-2.38	-2.77	-2.86	-2.48
	0	NA	NA	NA	NA
Cumulative probability for participant of average ability level	1	90.2%	89.4%	90.2%	90.0%
	0	100%	100%	100%	100%

Frequencies			
Groups	Points	Frequencies	Percent (%)
Complete sample for this math problem (n = 583)	1	510	87.5%
	0	73	12.5%
Female (n = 189)	1	148	78.3%
	0	41	21.7%
Male (n = 382)	1	350	91.6%
	0	32	8.4%
German as primary language at home (n = 433)	1	381	88.0%
	0	52	12.0%
Other language as primary language at home (n = 142)	1	121	85.2%
	0	21	14.8%
Secondary school completed in Germany (n = 512)	1	447	87.3%
	0	65	12.7%
Secondary school completed abroad (n = 65)	1	57	87.7%
	0	8	12.3%
Math not attended as advanced course in secondary school (n = 194)	1	162	83.5%
	0	32	16.5%
Math attended as advanced course in secondary school (n = 324)	1	294	90.7%
	0	30	9.3%
No math preparatory course attended (n = 274)	1	236	86.1%
	0	38	13.9%
Math preparatory course attended (n = 299)	1	265	88.6%
	0	34	11.4%
University of applied sciences (n = 147)	1	121	82.3%
	0	26	17.7%
University (n = 436)	1	389	89.2%
	0	47	10.8%
Online Participation (n = 415)	1	366	88.2%
	0	49	11.8%
Pen-and-Paper Participation (n = 168)	1	144	85.7%
	0	24	14.3%
Attended Gymnasium (n = 420)	1	368	87.6%
	0	52	12.4%
Attended Other Secondary School (n = 143)	1	123	86.0%
	0	20	14.0%

Note. Due to missing values on demographics questions, frequencies within groups may not add up to the total number of responses.

Plots

All plots are generated from **Model A1**.

Item Information

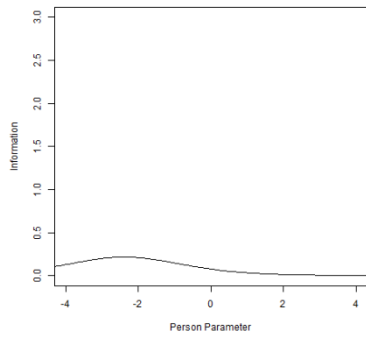

Expected Score

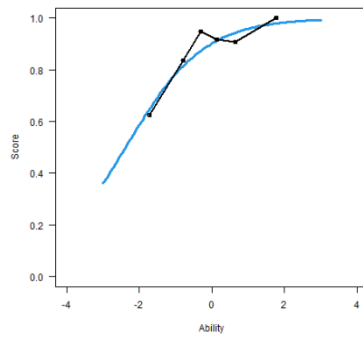

Probability

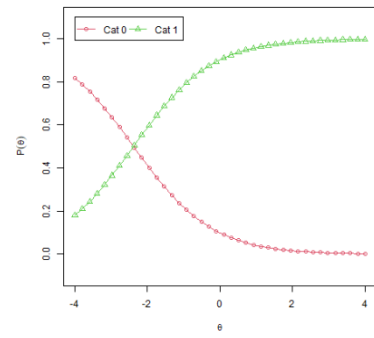

Note. The blue line represents expected performance, and the black line represents actual performance.

Note. Cat n = probability of receiving n points.

4.1.7. Price and Weight (GR7)

Preis und Gewicht

Berechnen Sie ohne Taschenrechner oder andere technische Hilfsmittel.

Ergänzen Sie das freie Feld.

Wenn 4 kg Äpfel 14€ kosten, was ergibt sich dann bei gleichem Grundpreis in folgender Situation?

Für 10,50€ können bis zu kg Äpfel gekauft werden.

Math Problem ID

GR7

Correct Answers and Answer Frequencies

Correct Answer(s)	Number Correct Answers	Number Incorrect Answers
blinded	blinded	blinded

Note. Scoring (PCS4): Every correct response is worth one point (up to 1 point possible).

Item Characteristics

Discrimination					
Measurement Type		Model A1	Model B	Model C	Model D
Correlation to participant ability (θ)		0.45	0.33	0.33	0.34
Discrimination Parameter (α)		1.33	0.97	0.97	1.20
Difficulty					
Measurement Type	Points	Model A1	Model B	Model C	Model D
Difficulty for participant of average ability level	1	-1.59	-1.97	-2.09	-1.70
	0	NA	NA	NA	NA
Cumulative probability for participant of average ability level	1	89.2%	87.2%	88.4%	88.5%
	0	100%	100%	100%	100%
Frequencies					
Groups	Points	Frequencies		Percent (%)	
Complete sample for this math problem (n = 579)	1	486		83.9%	
	0	93		16.1%	
Female (n = 189)	1	142		75.1%	
	0	47		24.9%	
Male (n = 379)	1	335		88.4%	
	0	44		11.6%	

Frequencies			
Groups	Points	Frequencies	Percent (%)
German as primary language at home (n = 430)	1	359	83.5%
	0	71	16.5%
Other language as primary language at home (n = 142)	1	122	85.9%
	0	20	14.1%
Secondary school completed in Germany (n = 509)	1	428	84.1%
	0	81	15.9%
Secondary school completed abroad (n = 65)	1	56	86.2%
	0	9	13.8%
Math not attended as advanced course in secondary school (n = 192)	1	147	76.6%
	0	45	23.4%
Math attended as advanced course in secondary school (n = 323)	1	283	87.6%
	0	40	12.4%
No math preparatory course attended (n = 273)	1	219	80.2%
	0	54	19.8%
Math preparatory course attended (n = 297)	1	259	87.2%
	0	38	12.8%
University of applied sciences (n = 146)	1	114	78.1%
	0	32	21.9%
University (n = 433)	1	372	85.9%
	0	61	14.1%
Online Participation (n = 411)	1	360	87.6%
	0	51	12.4%
Pen-and-Paper Participation (n = 168)	1	126	75.0%
	0	42	25.0%
Attended Gymnasium (n = 419)	1	365	87.1%
	0	54	12.9%
Attended Other Secondary School (n = 141)	1	108	76.6%
	0	33	23.4%

Note. Due to missing values on demographics questions, frequencies within groups may not add up to the total number of responses.

Plots

All plots are generated from **Model A1**.

Item Information

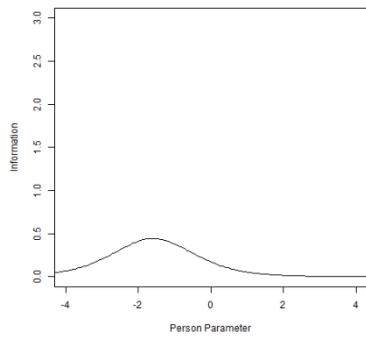

Expected Score

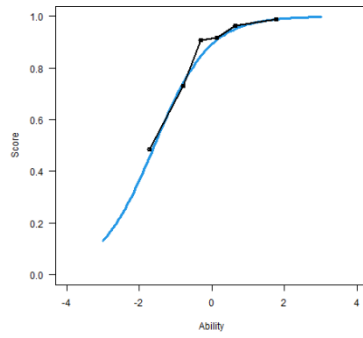

Probability

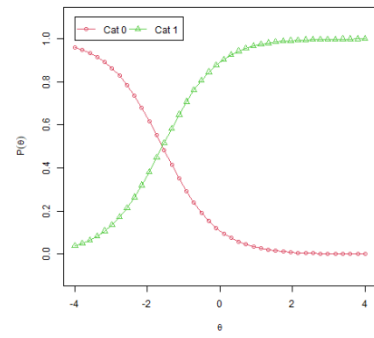

Note. The blue line represents expected performance, and the black line represents actual performance.

Note. Cat n = probability of receiving n points.

4.1.8. Work and Time Requirements (GR8)

Arbeit und Zeitbedarf

Berechnen Sie ohne Taschenrechner oder andere technische Hilfsmittel.

Ergänzen Sie das freie Feld.

Drei Maler benötigen zusammen 8 Stunden, um eine Wohnung zu streichen. Was ergibt sich dann bei Malern mit dem gleichen Arbeitstempo in der folgenden Situation?

4 Maler würden Stunden benötigen.

Math Problem ID

GR8

Correct Answers and Answer Frequencies

Correct Answer(s)	Number Correct Answers	Number Incorrect Answers
blinded	blinded	blinded

Note. Scoring (PCS4): Every correct response is worth one point (up to 1 point possible).

Item Characteristics

Discrimination					
Measurement Type		Model A1	Model B	Model C	Model D
Correlation to participant ability (θ)		0.41	0.35	0.35	0.36
Discrimination Parameter (α)		0.77	0.73	0.73	0.77
Difficulty					
Measurement Type	Points	Model A1	Model B	Model C	Model D
Difficulty for participant of average ability level	1	-0.43	-0.46	-0.57	-0.43
	0	NA	NA	NA	NA
Cumulative probability for participant of average ability level	1	58.1%	58.3%	60.3%	58.3%
	0	100%	100%	100%	100%
Frequencies					
Groups	Points	Frequencies		Percent (%)	
Complete sample for this math problem (n = 578)	1	334		57.8%	
	0	244		42.2%	
Female (n = 189)	1	93		49.2%	
	0	96		50.8%	
Male (n = 379)	1	237		62.5%	
	0	142		37.5%	

Frequencies			
Groups	Points	Frequencies	Percent (%)
German as primary language at home (n = 429)	1	256	59.7%
	0	173	40.3%
Other language as primary language at home (n = 142)	1	75	52.8%
	0	67	47.2%
Secondary school completed in Germany (n = 508)	1	296	58.3%
	0	212	41.7%
Secondary school completed abroad (n = 65)	1	37	56.9%
	0	28	43.1%
Math not attended as advanced course in secondary school (n = 191)	1	96	50.3%
	0	95	49.7%
Math attended as advanced course in secondary school (n = 323)	1	201	62.2%
	0	122	37.8%
No math preparatory course attended (n = 272)	1	141	51.8%
	0	131	48.2%
Math preparatory course attended (n = 297)	1	188	63.3%
	0	109	36.7%
University of applied sciences (n = 146)	1	79	54.1%
	0	67	45.9%
University (n = 432)	1	255	59.0%
	0	177	41.0%
Online Participation (n = 410)	1	243	59.3%
	0	167	40.7%
Pen-and-Paper Participation (n = 168)	1	91	54.2%
	0	77	45.8%
Attended Gymnasium (n = 418)	1	245	58.6%
	0	173	41.4%
Attended Other Secondary School (n = 141)	1	80	56.7%
	0	61	43.3%

Note. Due to missing values on demographics questions, frequencies within groups may not add up to the total number of responses.

Plots

All plots are generated from **Model A1**.

Item Information

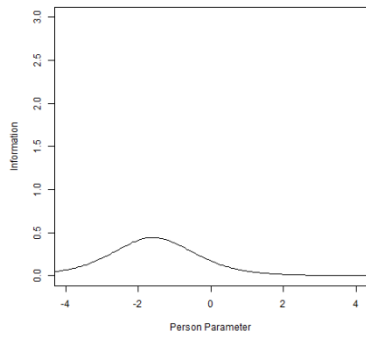

Expected Score

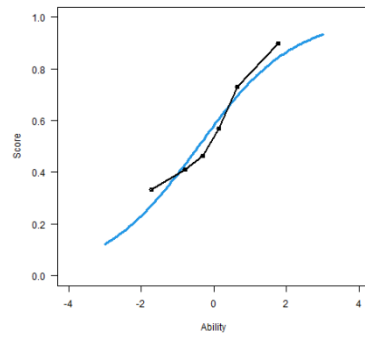

Note. The blue line represents expected performance, and the black line represents actual performance.

Probability

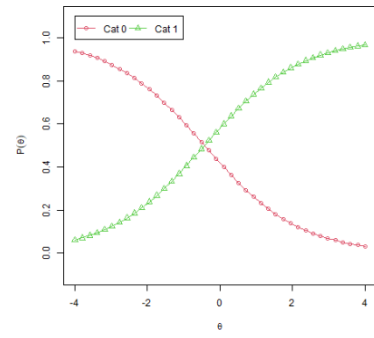

Note. Cat n = probability of receiving n points.

4.1.9. Lowest Common Denominator in Fractions (GR9)

Kleinster gemeinsamer Nenner in Brüchen

Bei welchen der folgenden Fragestellungen innerhalb der Bruchrechnung ist das Bestimmen von kleinsten gemeinsamen Nennern notwendig?

Wählen Sie eine oder mehrere richtige Antworten.

- Multiplikation von Brüchen
- Kehrwertbestimmung
- Division von Brüchen
- Subtraktion von Brüchen
- Größenvergleich von Brüchen

Note. This problem was changed during the final revision of the scoring rules, resulting in the removal of the last distractor. The reason for the change and an overview of the psychometric properties of the problem using the previous scoring rules can be found in **Appendix 8.1**.

Math Problem ID

GR9

Changes to the Problem After the Main Study

This problem was changed after the main study. The reason for the implemented changes and results of qualitative interviews testing the revised version are reported in **Section 5**.

Correct Answers and Answer Frequencies

Answer	Correct Answer(s)	Number Correct Answers	Number Incorrect Answers
Multiplikation von Brüchen	blinded	blinded	blinded
Kehrwertbestimmung	blinded	blinded	blinded
Division von Brüchen	blinded	blinded	blinded
Subtraktion von Brüchen	blinded	blinded	blinded

Note. Scoring (PCS4): Every correct response and correct rejection is worth one point (up to 4 points possible). Answer option “Größenvergleich von Brüchen” was removed from the analyses in PCS4.

Item Characteristics

Discrimination					
Measurement Type		Model A1	Model B	Model C	Model D
Correlation to participant ability (θ)		0.47	0.47	0.50	0.47
Discrimination Parameter (α)		0.47	0.52	0.90	0.53
Difficulty					
Measurement Type	Points	Model A1	Model B	Model C	Model D
Difficulty for participant of average ability level	4	-0.74	-0.78	-0.77	-0.74
	3	-1.30	-1.31	-1.25	-1.26
	2	-2.21	-2.18	-2.06	-2.11
	1	-3.26	-3.16	-3.36	-3.08
	0	NA	NA	NA	NA
Cumulative probability for participant of average ability level	4	66.4%	68.3%	75.2%	67.9%
	3	80.7%	82.7%	90.5%	82.4%
	2	93.9%	95.0%	98.5%	94.9%
	1	98.2%	98.6%	99.9%	98.6%
	0	100%	100%	100%	100%
Frequencies					
Groups	Points	Frequencies		Percent (%)	
Complete sample for this math problem (n = 565)	4	356		63.0%	
	3	74		13.1%	
	2	78		13.8%	
	1	34		6.0%	
	0	23		4.1%	
Female (n = 202)	4	122		60.4%	
	3	29		14.4%	
	2	24		11.9%	
	1	17		8.4%	
	0	10		5.0%	
Male (n = 348)	4	227		65.2%	
	3	42		12.1%	
	2	49		14.1%	
	1	17		4.9%	
	0	13		3.7%	
German as primary language at home (n = 407)	4	281		69.0%	
	3	50		12.3%	
	2	47		11.5%	
	1	16		3.9%	
	0	13		3.2%	

Frequencies			
Groups	Points	Frequencies	Percent (%)
Other language as primary language at home (n = 150)	4	71	47.3%
	3	23	15.3%
	2	28	18.7%
	1	18	12.0%
	0	10	6.7%
Secondary school completed in Germany (n = 492)	4	320	65.0%
	3	68	13.8%
	2	61	12.4%
	1	26	5.3%
	0	17	3.5%
Secondary school completed abroad (n = 68)	4	35	51.5%
	3	5	7.4%
	2	14	20.6%
	1	8	11.8%
	0	6	8.8%
Math not attended as advanced course in secondary school (n = 204)	4	105	51.5%
	3	29	14.2%
	2	41	20.1%
	1	19	9.3%
	0	10	4.9%
Math attended as advanced course in secondary school (n = 300)	4	223	74.3%
	3	36	12.0%
	2	23	7.7%
	1	10	3.3%
	0	8	2.7%
No math preparatory course attended (n = 251)	4	130	51.8%
	3	37	14.7%
	2	46	18.3%
	1	22	8.8%
	0	16	6.4%
Math preparatory course attended (n = 304)	4	222	73.0%
	3	36	11.8%
	2	28	9.2%
	1	12	3.9%
	0	6	2.0%
University of applied sciences (n = 146)	4	71	48.6%
	3	24	16.4%
	2	23	15.8%
	1	17	11.6%
	0	11	7.5%
University (n = 419)	4	285	68.0%
	3	50	11.9%
	2	55	13.1%
	1	17	4.1%
	0	12	2.9%

Frequencies			
Groups	Points	Frequencies	Percent (%)
Online Participation (n = 398)	4	247	62.1%
	3	53	13.3%
	2	61	15.3%
	1	23	5.8%
	0	14	3.5%
Pen-and-Paper Participation (n = 167)	4	109	65.3%
	3	21	12.6%
	2	17	10.2%
	1	11	6.6%
	0	9	5.4%
Attended Gymnasium (n = 403)	4	278	69.0%
	3	52	12.9%
	2	44	10.9%
	1	16	4.0%
	0	13	3.2%
Attended Other Secondary School (n = 143)	4	73	51.0%
	3	18	12.6%
	2	29	20.3%
	1	14	9.8%
	0	9	6.3%

Note. Due to missing values on demographics questions, frequencies within groups may not add up to the total number of responses.

Plots

All plots are generated from **Model A1**.

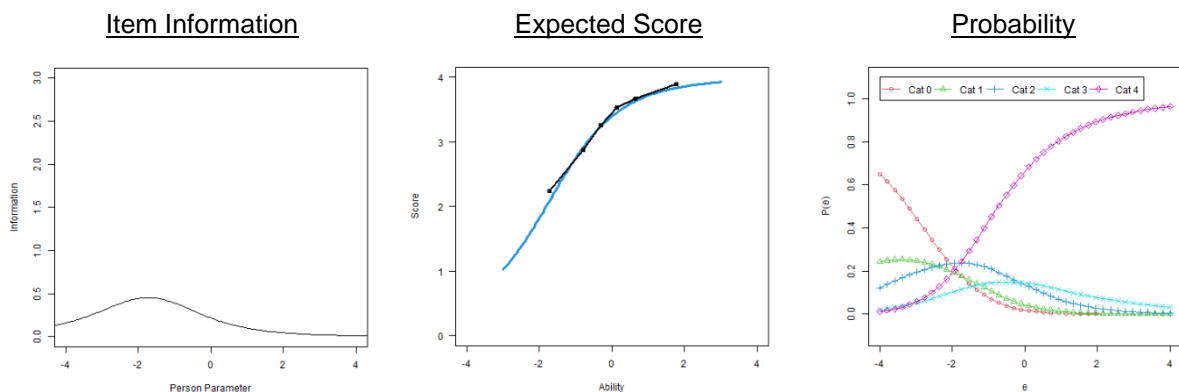

Note. The blue line represents expected performance, and the black line represents actual performance.

Note. Cat n = probability of receiving n points.

Differential Item Functioning (DIF)

This problem shows DIF across primary language. The difficulty (β) parameter was significantly higher for those who spoke a different language than German as their primary language at home. Meanwhile, the discrimination (α) parameter was significantly lower for those who spoke a different language than German at home. This shows that the problem was significantly easier and more informative for those who spoke German at home.

Expected Score (German as primary language)

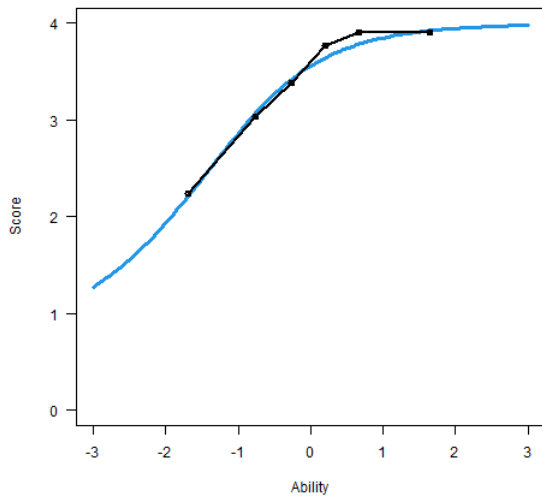

Expected Score (other primary language)

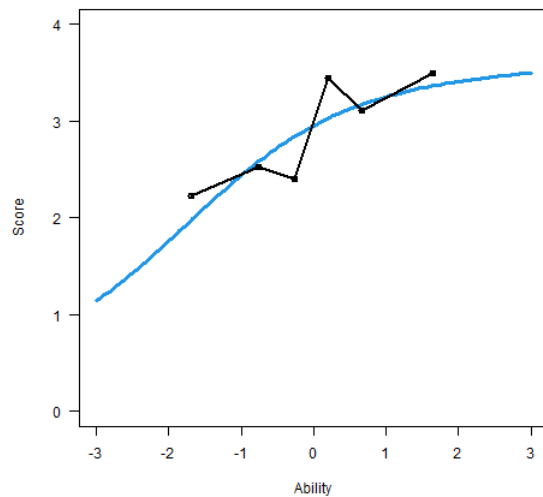

Note. The blue line represents expected performance, and the black line represents actual performance.

4.1.10. Conversions Between Fraction Representations (GR10)

Umwandeln zwischen Bruchdarstellungen

Welche der folgenden Angaben beschreiben denselben Anteil?

Wählen Sie eine oder mehrere Antworten.

Hinweis: Mindestens zwei der Antwortmöglichkeiten beschreiben denselben Anteil.

$\frac{9}{63}$

5 von 35

7%

0,7

Jeder Siebte

Math Problem ID

GR10

Correct Answers and Answer Frequencies

Answer	Correct Answer(s)	Number Correct Answers	Number Incorrect Answers
$\frac{9}{63}$	blinded	blinded	blinded
5 von 35	blinded	blinded	blinded
7%	blinded	blinded	blinded
0,7	blinded	blinded	blinded
Jeder Siebte	blinded	blinded	blinded

Note. Scoring (PCS4): The first two correct responses and/or correct rejections are worth one point, each additional correct response or correct rejection is worth one additional point (up to 4 points possible).

Item Characteristics

Discrimination					
Measurement Type		Model A1	Model B	Model C	Model D
Correlation to participant ability (θ)		0.67	0.59	0.60	0.60
Discrimination Parameter (α)		0.73	0.61	0.85	0.75
Difficulty					
Measurement Type	Points	Model A1	Model B	Model C	Model D
Difficulty for participant of average ability level	4	0.49	0.49	0.27	0.44
	3	-0.69	-0.82	-0.88	-0.73
	2	-0.91	-1.07	-1.19	-0.96
	1	-1.87	-2.14	-2.18	-1.90
	0	NA	NA	NA	NA
Cumulative probability for participant of average ability level	4	36.8%	38.6%	42.0%	37.9%
	3	76.7%	77.2%	83.3%	78.5%
	2	84.4%	84.5%	91.9%	86.0%
	1	95.7%	95.5%	98.6%	96.4%
	0	100%	100%	100%	100%
Frequencies					
Groups	Points	Frequencies	Percent (%)		
Complete sample for this math problem (n = 559)	4	207	37.0%		
	3	176	31.5%		
	2	37	6.6%		
	1	80	14.3%		
	0	59	10.6%		
Female (n = 199)	4	59	29.6%		
	3	61	30.7%		
	2	15	7.5%		
	1	38	19.1%		
	0	26	13.1%		
Male (n = 345)	4	142	41.2%		
	3	110	31.9%		
	2	20	5.8%		
	1	41	11.9%		
	0	32	9.3%		
German as primary language at home (n = 404)	4	157	38.9%		
	3	114	28.2%		
	2	28	6.9%		
	1	63	15.6%		
	0	42	10.4%		

Frequencies			
Groups	Points	Frequencies	Percent (%)
Other language as primary language at home (n = 147)	4	47	32.0%
	3	59	40.1%
	2	9	6.1%
	1	16	10.9%
	0	16	10.9%
Secondary school completed in Germany (n = 487)	4	177	36.3%
	3	151	31.0%
	2	32	6.6%
	1	75	15.4%
	0	52	10.7%
Secondary school completed abroad (n = 67)	4	28	41.8%
	3	23	34.3%
	2	5	7.5%
	1	5	7.5%
	0	6	9.0%
Math not attended as advanced course in secondary school (n = 203)	4	35	17.2%
	3	71	35.0%
	2	20	9.9%
	1	46	22.7%
	0	31	15.3%
Math attended as advanced course in secondary school (n = 296)	4	152	51.4%
	3	86	29.1%
	2	13	4.4%
	1	28	9.5%
	0	17	5.7%
No math preparatory course attended (n = 247)	4	77	31.2%
	3	84	34.0%
	2	15	6.1%
	1	37	15.0%
	0	34	13.8%
Math preparatory course attended (n = 302)	4	127	42.1%
	3	87	28.8%
	2	22	7.3%
	1	43	14.2%
	0	23	7.6%
University of applied sciences (n = 146)	4	28	19.2%
	3	54	37.0%
	2	11	7.5%
	1	33	22.6%
	0	20	13.7%
University (n = 413)	4	179	43.3%
	3	122	29.5%
	2	26	6.3%
	1	47	11.4%
	0	39	9.4%

Frequencies			
Groups	Points	Frequencies	Percent (%)
Online Participation (n = 393)	4	146	37.2%
	3	131	33.3%
	2	21	5.3%
	1	54	13.7%
	0	41	10.4%
Pen-and-Paper Participation (n = 166)	4	61	36.7%
	3	45	27.1%
	2	16	9.6%
	1	26	15.7%
	0	18	10.8%
Attended Gymnasium (n = 399)	4	162	40.6%
	3	123	30.8%
	2	25	6.3%
	1	53	13.3%
	0	36	9.0%
Attended Other Secondary School (n = 141)	4	41	29.1%
	3	45	31.9%
	2	9	6.4%
	1	25	17.7%
	0	21	14.9%

Note. Due to missing values on demographics questions, frequencies within groups may not add up to the total number of responses.

Plots

All plots are generated from **Model A1**.

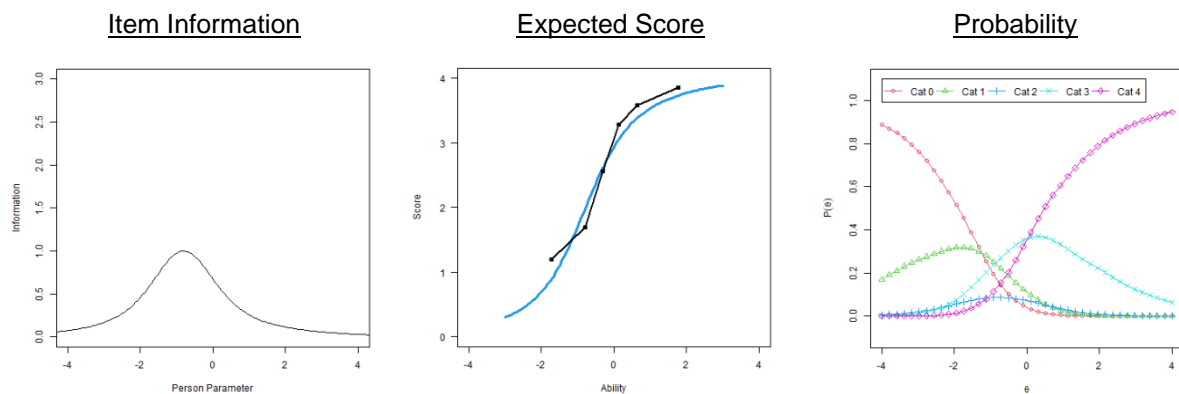

Note. The blue line represents expected performance, and the black line represents actual performance.

Note. Cat n = probability of receiving n points.

Differential Item Functioning (DIF)

This problem shows DIF based on attending math as an advanced or regular course in high school. The difficulty (β) parameter was significantly lower for those who attended math as an advanced course. Meanwhile, the discrimination (α) parameter was significantly higher for the same group. This shows that the problem was significantly easier and more informative for those who took math as an advanced course in high school.

Expected Score (math attended as advanced course in high school)

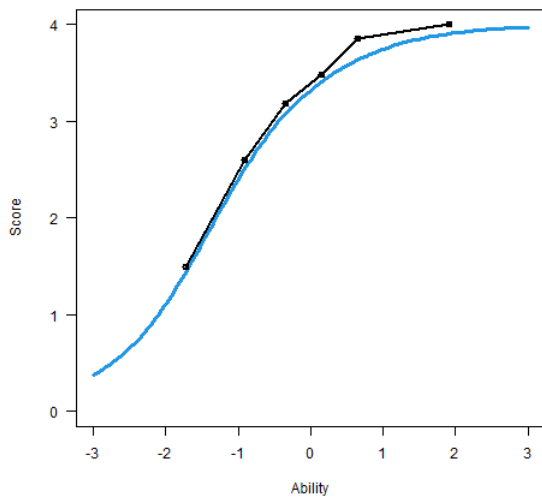

Expected Score (math not attended as advanced course in high school)

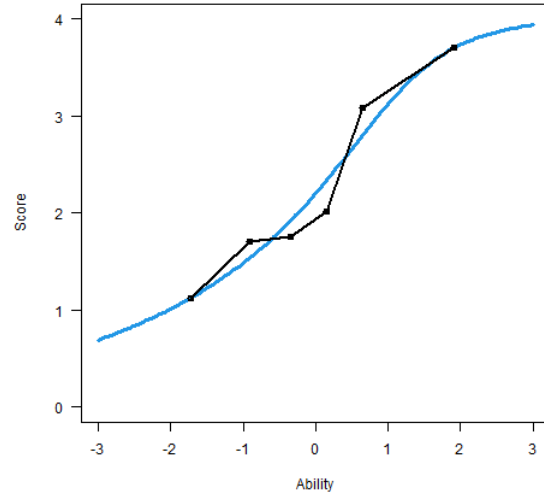

Note. The blue line represents expected performance, and the black line represents actual performance.

4.1.11. Decimal Representation (GR11)

Dezimaldarstellung

Welche der folgenden Zahlen ist die Dezimaldarstellung von $\frac{12}{55}$?

Wählen Sie die richtige Antwort.

0,0218	0,218	0,218	0,218	0,0218
--------	-------	-------	-------	--------

Note. This problem was removed during the final revision of the scoring. The reason for the change and an overview of the psychometric properties of the problem using the previous scoring rules can be found in **Appendix 8.1**.

Math Problem ID

GR11

Problem Cut

4.1.12. Sets (GR12)

Mengen

Entscheiden Sie in jeder Zelle der Tabelle, ob das jeweilige Element in der jeweiligen Menge enthalten ist. Kreuzen Sie an, falls es enthalten ist.

	Z	Q	R
-2	<input type="checkbox"/>	<input type="checkbox"/>	<input type="checkbox"/>
$\frac{1}{2}$	<input type="checkbox"/>	<input type="checkbox"/>	<input type="checkbox"/>
$\sqrt{2}$	<input type="checkbox"/>	<input type="checkbox"/>	<input type="checkbox"/>
$0,\bar{3}$	<input type="checkbox"/>	<input type="checkbox"/>	<input type="checkbox"/>

Math Problem ID

GR12

Changes to the Problem After the Main Study

This problem was changed after the main study. The reason for the implemented changes and results of qualitative interviews testing the revised version are reported in **Section 5**.

Correct Answers and Answer Frequencies

Answer	Correct Answer(s)	Number Correct Answers	Number Incorrect Answers
$-2 \in \mathbb{Z}$	blinded	blinded	blinded
$-2 \in \mathbb{Q}$	blinded	blinded	blinded
$-2 \in \mathbb{R}$	blinded	blinded	blinded
$\frac{1}{2} \in \mathbb{Z}$	blinded	blinded	blinded
$\frac{1}{2} \in \mathbb{Q}$	blinded	blinded	blinded
$\frac{1}{2} \in \mathbb{R}$	blinded	blinded	blinded
$\sqrt{2} \in \mathbb{Z}$	blinded	blinded	blinded
$\sqrt{2} \in \mathbb{Q}$	blinded	blinded	blinded
$\sqrt{2} \in \mathbb{R}$	blinded	blinded	blinded
$0,\bar{3} \in \mathbb{Z}$	blinded	blinded	blinded
$0,\bar{3} \in \mathbb{Q}$	blinded	blinded	blinded
$0,\bar{3} \in \mathbb{R}$	blinded	blinded	blinded

Note. Scoring (PCS4): Answer options for each set of numbers were evaluated together. That is, if all answer options for a given set of numbers (one column) were correctly chosen or correctly not chosen, one point was earned (up to 3 points possible).

Item Characteristics

Discrimination					
Measurement Type		Model A1	Model B	Model C	Model D
Correlation to participant ability (θ)		0.72	0.66	0.67	0.67
Discrimination Parameter (α)		0.85	0.90	0.97	1.02
Difficulty					
Measurement Type	Points	Model A1	Model B	Model C	Model D
Difficulty for participant of average ability level	3	0.97	0.92	0.80	0.88
	2	0.10	0.08	-0.04	0.08
	1	-1.06	-1.04	-1.14	-0.98
	0	NA	NA	NA	NA
Cumulative probability for participant of average ability level	3	19.9%	19.8%	22.0%	18.4%
	2	46.3%	46.9%	51.7%	46.4%
	1	80.4%	81.2%	85.0%	82.1%
	0	100%	100%	100%	100%
Frequencies					
Groups	Points	Frequencies	Percent (%)		
Complete sample for this math problem (n = 574)	3	153	26.7%		
	2	126	22.0%		
	1	157	27.4%		
	0	138	24.0%		
Female (n = 188)	3	37	19.7%		
	2	38	20.2%		
	1	57	30.3%		
	0	56	29.8%		
Male (n = 377)	3	110	29.2%		
	2	86	22.8%		
	1	99	26.3%		
	0	82	21.8%		
German as primary language at home (n = 425)	3	117	27.5%		
	2	95	22.4%		
	1	106	24.9%		
	0	107	25.2%		
Other language as primary language at home (n = 142)	3	32	22.5%		
	2	31	21.8%		
	1	48	33.8%		
	0	31	21.8%		
Secondary school completed in Germany (n = 504)	3	130	25.8%		
	2	106	21.0%		
	1	137	27.2%		
	0	131	26.0%		

Frequencies			
Groups	Points	Frequencies	Percent (%)
Secondary school completed abroad (n = 65)	3	19	29.2%
	2	19	29.2%
	1	20	30.8%
	0	7	10.8%
Math not attended as advanced course in secondary school (n = 188)	3	29	15.4%
	2	33	17.6%
	1	58	30.9%
	0	68	36.2%
Math attended as advanced course in secondary school (n = 323)	3	108	33.4%
	2	76	23.5%
	1	82	25.4%
	0	57	17.6%
No math preparatory course attended (n = 270)	3	52	19.3%
	2	51	18.9%
	1	78	28.9%
	0	89	33.0%
Math preparatory course attended (n = 295)	3	96	32.5%
	2	74	25.1%
	1	76	25.8%
	0	49	16.6%
University of applied sciences (n = 145)	3	17	11.7%
	2	23	15.9%
	1	48	33.1%
	0	57	39.3%
University (n = 429)	3	136	31.7%
	2	103	24.0%
	1	109	25.4%
	0	81	18.9%
Online Participation (n = 406)	3	108	26.6%
	2	91	22.4%
	1	114	28.1%
	0	93	22.9%
Pen-and-Paper Participation (n = 168)	3	45	26.8%
	2	35	20.8%
	1	43	25.6%
	0	45	26.8%
Attended Gymnasium (n = 414)	3	121	29.2%
	2	98	23.7%
	1	113	27.3%
	0	82	19.8%
Attended Other Secondary School (n = 141)	3	27	19.1%
	2	23	16.3%
	1	42	29.8%
	0	49	34.8%

Note. Due to missing values on demographics questions, frequencies within groups may not add up to the total number of responses.

Plots

All plots are generated from **Model A1**.

Item Information

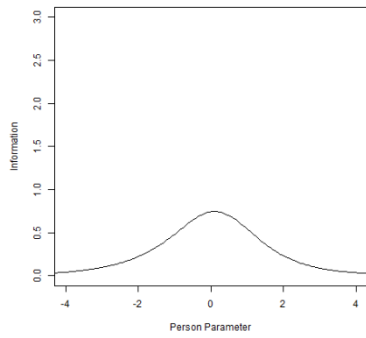

Expected Score

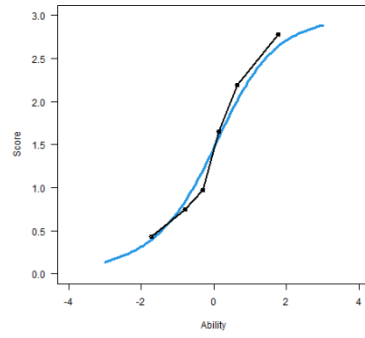

Note. The blue line represents expected performance, and the black line represents actual performance.

Probability

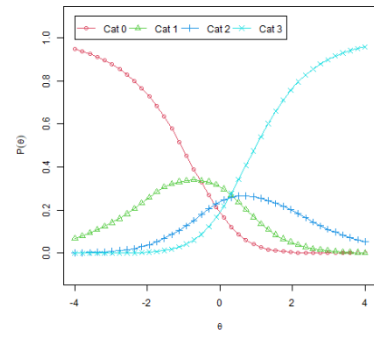

Note. Cat n = probability of receiving n points.

4.1.13. Estimation / Rough Calculations (GR13)

Überschlag / Größenvorstellung

Überschlagen Sie, wie viele Sekunden ein Monat hat.

Wählen Sie die richtige Antwort.

2 500 000	A
500 000	B
1 500 000	C
10 000 000	D
45 000	E

Math Problem ID

GR13

Correct Answers and Answer Frequencies

Correct Answer	Number Correct Answers	Number Incorrect Answers ^a	Answer Frequencies				
			A	B	C	D	E
blinded	blinded	blinded	blinded	blinded	blinded	blinded	blinded

Note. Scoring (PCS4): Every correct response is worth one point (up to 1 point possible).

^a Includes cases, where the problem was seen but not answered.

Item Characteristics

Discrimination					
Measurement Type		Model A1	Model B	Model C	Model D
Correlation to participant ability (θ)		0.32	0.22	0.22	0.23
Discrimination Parameter (α)		0.66	0.46	0.48	0.56
Difficulty					
Measurement Type	Points	Model A1	Model B	Model C	Model D
Difficulty for participant of average ability level	1	-1.33	-1.91	-1.97	-1.57
	0	NA	NA	NA	NA
Cumulative probability for participant of average ability level	1	70.6%	70.5%	71.9%	70.7%
	0	100%	100%	100%	100%

Frequencies			
Groups	Points	Frequencies	Percent (%)
Complete sample for this math problem (n = 557)	1	385	69.1%
	0	172	30.9%
Female (n = 198)	1	130	65.7%
	0	68	34.3%
Male (n = 345)	1	243	70.4%
	0	102	29.6%
German as primary language at home (n = 404)	1	279	69.1%
	0	125	30.9%
Other language as primary language at home (n = 146)	1	101	69.2%
	0	45	30.8%
Secondary school completed in Germany (n = 486)	1	331	68.1%
	0	155	31.9%
Secondary school completed abroad (n = 67)	1	51	76.1%
	0	16	23.9%
Math not attended as advanced course in secondary school (n = 202)	1	132	65.3%
	0	70	34.7%
Math attended as advanced course in secondary school (n = 295)	1	208	70.5%
	0	87	29.5%
No math preparatory course attended (n = 246)	1	164	66.7%
	0	82	33.3%
Math preparatory course attended (n = 301)	1	215	71.4%
	0	86	28.6%
University of applied sciences (n = 145)	1	94	64.8%
	0	51	35.2%
University (n = 412)	1	291	70.6%
	0	121	29.4%
Online Participation (n = 391)	1	286	73.1%
	0	105	26.9%
Pen-and-Paper Participation (n = 166)	1	99	59.6%
	0	67	40.4%
Attended Gymnasium (n = 398)	1	279	70.1%
	0	119	29.9%
Attended Other Secondary School (n = 141)	1	91	64.5%
	0	50	35.5%

Note. Due to missing values on demographics questions, frequencies within groups may not add up to the total number of responses.

Plots

All plots are generated from **Model A1**.

Item Information

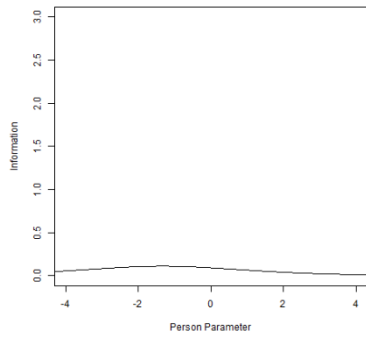

Expected Score

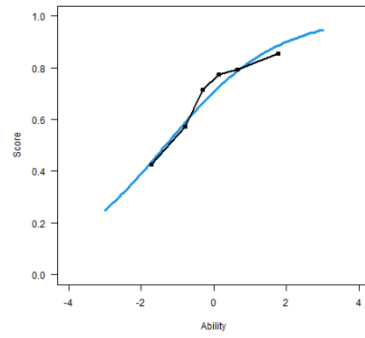

Probability

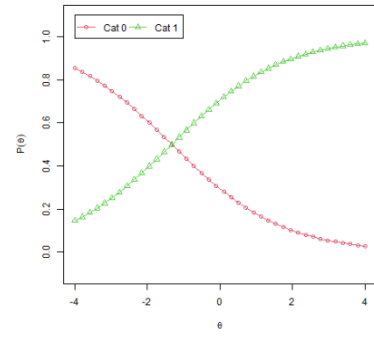

Note. The blue line represents expected performance, and the black line represents actual performance.

Note. Cat n = probability of receiving n points.

4.2. Exponents, Roots, Logarithms (Potenzen, Wurzeln, Logarithmen; P)

Q₃ Statistics for Exponents, Roots, Logarithms

	P1	P2	P3	P4	P5	P6	P7	P8	P9	P10
P1	-									
P2	-.171	-								
P3	.037	-.073	-							
P4	.215	-.094	.335	-						
P5	-.013	-.143	.055	.334	-					
P6	-.212	.030	-.063	-.105	-.125	-				
P7	-.177	.078	-.027	-.031	-.152	.013	-			
P8	.064	-.118	.077	.295	.082	-.144	-.116	-		
P9	.064	-.078	.293	.435	.173	-.015	.017	.259	-	
P10	-.296	.035	-.259	-.348	-.159	-.047	-.062	-.234	-.263	-

Note. Q₃ statistics above the critical absolute value of 0.20 are bolded. For details see **Section 3.1**.

4.2.1. Simplification and Calculating Rational Denominators (P1)

Teilweise radizieren und Nenner rational machen

Wandeln Sie in ein Produkt um, dessen Restwurzel man nicht mehr weiter vereinfachen kann. Machen Sie bei dem Bruch den Nenner rational und geben Sie das Ergebnis vollständig gekürzt an.

Beispiel: $\sqrt{50} = \sqrt{25 \cdot 2} = 5 \cdot \sqrt{2}$

Ergänzen Sie die freien Felder.

a)

$$\sqrt{28} = \square \cdot \sqrt{\square}$$

b)

$$\frac{2}{\sqrt{3}} = \frac{\square}{\square} \cdot \sqrt{\square}$$

Math Problem ID

P1

Correct Answers and Answer Frequencies

Math Problem Part	Blank	Correct Answer(s)	Number Correct Answers	Number Incorrect Answers
a)	1	blinded	blinded	blinded
	2	blinded	blinded	blinded
b)	1	blinded	blinded	blinded
	2	blinded	blinded	blinded
	3	blinded	blinded	blinded

Note. Scoring (PCS4): For Part a), both blanks must be correct to earn 1 point. For Part b), all three blanks must be correct to earn one point (up to 2 points possible for the whole problem).

Item Characteristics

Discrimination					
Measurement Type		Model A2	Model B	Model C	Model D
Correlation to participant ability (θ)		0.74	0.68	0.67	0.70
Discrimination Parameter (α)		1.43	1.47	1.17	1.53
Difficulty					
Measurement Type	Points	Model A2	Model B	Model C	Model D
Difficulty for participant of average ability level	2	0.45	0.42	0.40	0.42
	1	-0.65	-0.66	-0.90	-0.65
	0	NA	NA	NA	NA
Cumulative probability for participant of average ability level	2	30.7%	31.3%	35.7%	30.7%
	1	76.8%	77.8%	80.1%	78.1%
	0	100%	100%	100%	100%
Frequencies					
Groups	Points	Frequencies		Percent (%)	
Complete sample for this math problem (n = 586)	2	209		35.7%	
	1	192		32.8%	
	0	185		31.6%	
Female (n = 188)	2	58		30.9%	
	1	62		33.0%	
	0	68		36.2%	
Male (n = 389)	2	149		38.3%	
	1	126		32.4%	
	0	114		29.3%	
German as primary language at home (n = 435)	2	134		30.8%	
	1	155		35.6%	
	0	146		33.6%	
Other language as primary language at home (n = 144)	2	74		51.4%	
	1	34		23.6%	
	0	36		25.0%	
Secondary school completed in Germany (n = 518)	2	161		31.1%	
	1	180		34.7%	
	0	177		34.2%	
Secondary school completed abroad (n = 62)	2	47		75.8%	
	1	10		16.1%	
	0	5		8.1%	
Math not attended as advanced course in secondary school (n = 214)	2	34		15.9%	
	1	59		27.6%	
	0	121		56.5%	
Math attended as advanced course in secondary school (n = 319)	2	144		45.1%	
	1	123		38.6%	
	0	52		16.3%	

Frequencies			
Groups	Points	Frequencies	Percent (%)
No math preparatory course attended (n = 259)	2	76	29.3%
	1	83	32.0%
	0	100	38.6%
Math preparatory course attended (n = 318)	2	130	40.9%
	1	106	33.3%
	0	82	25.8%
University of applied sciences (n = 146)	2	31	21.2%
	1	42	28.8%
	0	73	50.0%
University (n = 440)	2	178	40.5%
	1	150	34.1%
	0	112	25.5%
Online Participation (n = 407)	2	150	36.9%
	1	119	29.2%
	0	138	33.9%
Pen-and-Paper Participation (n = 179)	2	59	33.0%
	1	73	40.8%
	0	47	26.3%
Attended Gymnasium (n = 420)	2	158	37.6%
	1	150	35.7%
	0	112	26.7%
Attended Other Secondary School (n = 151)	2	48	31.8%
	1	36	23.8%
	0	67	44.4%

Note. Due to missing values on demographics questions, frequencies within groups may not add up to the total number of responses.

Plots

All plots are generated from **Model A2**.

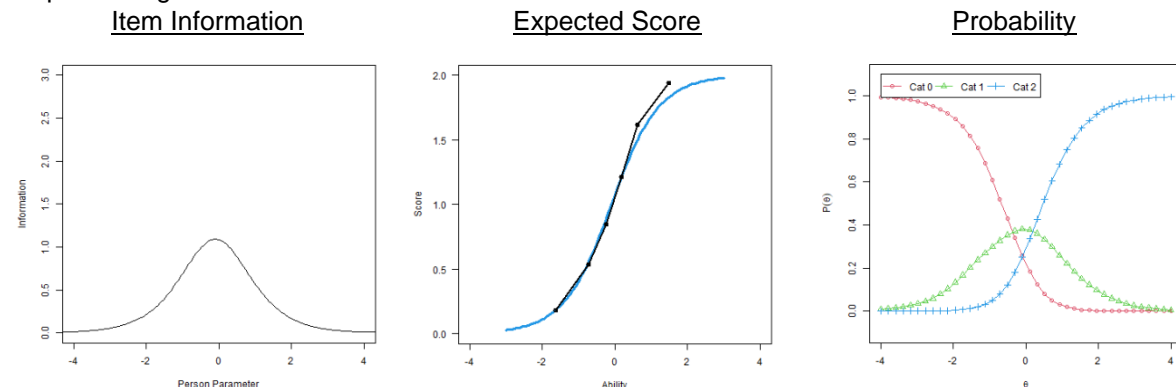

Note. The blue line represents expected performance, and the black line represents actual performance.

Note. Cat n = probability of receiving n points.

4.2.2. Power-of-ten Notation (P2)

Zehnerpotenz-Schreibweise

Wandeln Sie in ein Produkt um, das aus einer Dezimalzahl zwischen 1 und 9,9 und einer Zehnerpotenz besteht. Geben Sie beim letzten Feld die zugehörige Dezimalzahl auf der linken Seite ein.

Beispiel: $87\,000 = 8,7 \cdot 10^4$ (als Eingabe: $8,7*10^4$)

Ergänzen Sie die freien Felder.

Schreibweise:
Nutzen Sie folgende Zeichen: + (Addition), - (Subtraktion), * (Multiplikation), / (Division), ^ (Potenz), () Klammern.

5 Millionen =

= $4,4 \cdot 10^{-4}$

Math Problem ID

P2

Correct Answers and Answer Frequencies

Blank	Correct Answer(s)	Number Correct Answers	Number Incorrect Answers
1	blinded	blinded	blinded
2	blinded	blinded	blinded

Note. Scoring (PCS4): Every correct response is worth one point (up to 2 points possible).

Item Characteristics

Discrimination					
Measurement Type		Model A2	Model B	Model C	Model D
Correlation to participant ability (θ)		0.55	0.48	0.49	0.48
Discrimination Parameter (α)		1.02	0.97	0.89	1.02
Difficulty					
Measurement Type	Points	Model A2	Model B	Model C	Model D
Difficulty for participant of average ability level	2	-0.86	-0.89	-1.12	-0.86
	1	-1.84	-1.89	-2.37	-1.83
	0	NA	NA	NA	NA
Cumulative probability for participant of average ability level	2	75.4%	75.2%	77.4%	75.6%
	1	95.2%	94.9%	96.6%	95.2%
	0	100%	100%	100%	100%

Frequencies			
Groups	Points	Frequencies	Percent (%)
Complete sample for this math problem (n = 550)	2	384	69.8%
	1	108	19.6%
	0	58	10.5%
Female (n = 172)	2	105	61.0%
	1	39	22.7%
	0	28	16.3%
Male (n = 371)	2	275	74.1%
	1	68	18.3%
	0	28	7.5%
German as primary language at home (n = 410)	2	291	71.0%
	1	73	17.8%
	0	46	11.2%
Other language as primary language at home (n = 134)	2	91	67.9%
	1	33	24.6%
	0	10	7.5%
Secondary school completed in Germany (n = 493)	2	341	69.2%
	1	98	19.9%
	0	54	11.0%
Secondary school completed abroad (n = 52)	2	41	78.8%
	1	9	17.3%
	0	2	3.8%
Math not attended as advanced course in secondary school (n = 199)	2	110	55.3%
	1	48	24.1%
	0	41	20.6%
Math attended as advanced course in secondary school (n = 304)	2	240	78.9%
	1	52	17.1%
	0	12	3.9%
No math preparatory course attended (n = 255)	2	164	64.3%
	1	55	21.6%
	0	36	14.1%
Math preparatory course attended (n = 288)	2	216	75.0%
	1	52	18.1%
	0	20	6.9%
University of applied sciences (n = 139)	2	73	52.5%
	1	40	28.8%
	0	26	18.7%
University (n = 411)	2	311	75.7%
	1	68	16.5%
	0	32	7.8%
Online Participation (n = 371)	2	245	66.0%
	1	76	20.5%
	0	50	13.5%
Pen-and-Paper Participation (n = 179)	2	139	77.7%
	1	32	17.9%
	0	8	4.5%

Frequencies			
Groups	Points	Frequencies	Percent (%)
Attended Gymnasium (n = 401)	2	303	75.6%
	1	69	17.2%
	0	29	7.2%
Attended Other Secondary School (n = 139)	2	75	54.0%
	1	37	26.6%
	0	27	19.4%

Note. Due to missing values on demographics questions, frequencies within groups may not add up to the total number of responses.

Plots

All plots are generated from **Model A2**.

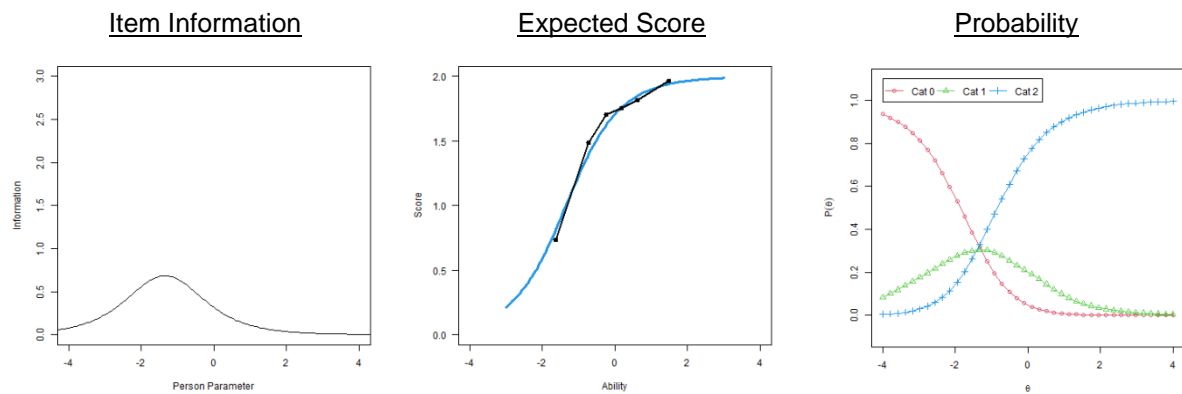

Note. The blue line represents expected performance, and the black line represents actual performance.

Note. Cat n = probability of receiving n points.

4.2.3. Simplifying Exponents (P3)

Potenzen vereinfachen

Vereinfachen Sie den folgenden Ausdruck, sodass ein vollständig gekürzter Ausdruck mit ausschließlich positiven Exponenten vorliegt. Es gilt $a, b, c > 0$.

Ergänzen Sie das freie Feld.

Beachten Sie: Nutzen Sie Klammern, um zwischen Zähler und Nenner zu trennen.

Schreibweise:
 Nutzen Sie folgende Zeichen: + (Addition), - (Subtraktion), * (Multiplikation), / (Division), ^ (Potenz), () Klammern.

$$\frac{a^2 \cdot b^3 \cdot c}{a^3 \cdot b} = \text{[]}$$

Math Problem ID

P3

Correct Answers and Answer Frequencies

Correct Answer(s)	Number Correct Answers	Number Incorrect Answers
blinded	blinded	blinded

Note. Scoring (PCS4): Every correct response is worth one point (up to 1 point possible).

Item Characteristics

Discrimination					
Measurement Type		Model A2	Model B	Model C	Model D
Correlation to participant ability (θ)		0.59	0.52	0.52	0.53
Discrimination Parameter (α)		1.74	1.69	1.30	1.78
Difficulty					
Measurement Type	Points	Model A2	Model B	Model C	Model D
Difficulty for participant of average ability level	1	-0.94	-0.97	-1.30	-0.94
	0	NA	NA	NA	NA
Cumulative probability for participant of average ability level	1	83.7%	83.6%	84.3%	84.3%
	0	100%	100%	100%	100%

Frequencies			
Groups	Points	Frequencies	Percent (%)
Complete sample for this math problem (n = 578)	1	430	74.4%
	0	148	25.6%
Female (n = 185)	1	128	69.2%
	0	57	30.8%
Male (n = 386)	1	296	76.7%
	0	90	23.3%
German as primary language at home (n = 430)	1	315	73.3%
	0	115	26.7%
Other language as primary language at home (n = 143)	1	112	78.3%
	0	31	21.7%
Secondary school completed in Germany (n = 512)	1	368	71.9%
	0	144	28.1%
Secondary school completed abroad (n = 62)	1	59	95.2%
	0	3	4.8%
Math not attended as advanced course in secondary school (n = 211)	1	114	54.0%
	0	97	46.0%
Math attended as advanced course in secondary school (n = 316)	1	278	88.0%
	0	38	12.0%
No math preparatory course attended (n = 256)	1	172	67.2%
	0	84	32.8%
Math preparatory course attended (n = 315)	1	253	80.3%
	0	62	19.7%
University of applied sciences (n = 146)	1	86	58.9%
	0	60	41.1%
University (n = 432)	1	344	79.6%
	0	88	20.4%
Online Participation (n = 399)	1	281	70.4%
	0	118	29.6%
Pen-and-Paper Participation (n = 179)	1	149	83.2%
	0	30	16.8%
Attended Gymnasium (n = 415)	1	338	81.4%
	0	77	18.6%
Attended Other Secondary School (n = 150)	1	81	54.0%
	0	69	46.0%

Note. Due to missing values on demographics questions, frequencies within groups may not add up to the total number of responses.

Plots

All plots are generated from **Model A2**.

Item Information

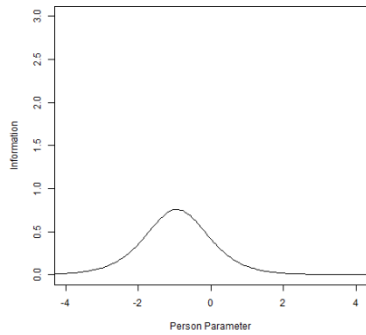

Expected Score

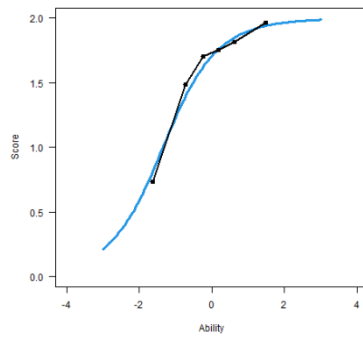

Note. The blue line represents expected performance, and the black line represents actual performance.

Probability

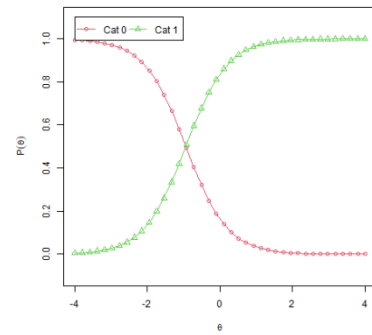

Note. Cat n = probability of receiving n points.

4.2.4. Calculating Exponents (P4)

Potenzen berechnen

Berechnen Sie und geben Sie das Ergebnis vollständig gekürzt oder als Dezimalzahl an.

Ergänzen Sie die freien Felder.

Beachten Sie: Nutzen Sie zum Ausdruck von Brüchen das Zeichen / (Division).

$$(-4)^{-2} = \text{[]}$$

$$\left(\frac{27}{125}\right)^{\frac{1}{3}} = \text{[]}$$

Math Problem ID

P4

Correct Answers and Answer Frequencies

Blank	Correct Answer(s)	Number Correct Answers	Number Incorrect Answers
1	blinded	blinded	blinded
2	blinded	blinded	blinded

Note. Scoring (PCS4): Every correct response is worth one point (up to 2 points possible).

Item Characteristics

Discrimination					
Measurement Type		Model A2	Model B	Model C	Model D
Correlation to participant ability (θ)		0.82	0.73	0.72	0.73
Discrimination Parameter (α)		2.43	1.82	1.47	2.13
Difficulty					
Measurement Type	Points	Model A2	Model B	Model C	Model D
Difficulty for participant of average ability level	2	0.29	0.29	0.22	0.29
	1	-0.42	-0.46	-0.64	-0.44
	0	NA	NA	NA	NA
Cumulative probability for participant of average ability level	2	29.4%	33.1%	39.4%	31.5%
	1	78.3%	75.4%	78.8%	77.1%
	0	100%	100%	100%	100%

Frequencies			
Groups	Points	Frequencies	Percent (%)
Complete sample for this math problem (n = 547)	2	216	39.5%
	1	144	26.3%
	0	187	34.2%
Female (n = 170)	2	59	34.7%
	1	47	27.6%
	0	64	37.6%
Male (n = 370)	2	155	41.9%
	1	96	25.9%
	0	119	32.2%
German as primary language at home (n = 407)	2	147	36.1%
	1	114	28.0%
	0	146	35.9%
Other language as primary language at home (n = 134)	2	68	50.7%
	1	28	20.9%
	0	38	28.4%
Secondary school completed in Germany (n = 490)	2	178	36.3%
	1	133	27.1%
	0	179	36.5%
Secondary school completed abroad (n = 52)	2	37	71.2%
	1	10	19.2%
	0	5	9.6%
Math not attended as advanced course in secondary school (n = 197)	2	35	17.8%
	1	47	23.9%
	0	115	58.4%
Math attended as advanced course in secondary school (n = 303)	2	154	50.8%
	1	87	28.7%
	0	62	20.5%
No math preparatory course attended (n = 253)	2	79	31.2%
	1	62	24.5%
	0	112	44.3%
Math preparatory course attended (n = 287)	2	134	46.7%
	1	81	28.2%
	0	72	25.1%
University of applied sciences (n = 138)	2	34	24.6%
	1	27	19.6%
	0	77	55.8%
University (n = 409)	2	182	44.5%
	1	117	28.6%
	0	110	26.9%
Online Participation (n = 368)	2	145	39.4%
	1	100	27.2%
	0	123	33.4%
Pen-and-Paper Participation (n = 179)	2	71	39.7%
	1	44	24.6%
	0	64	35.8%

Frequencies			
Groups	Points	Frequencies	Percent (%)
Attended Gymnasium (n = 398)	2	169	42.5%
	1	116	29.1%
	0	113	28.4%
Attended Other Secondary School (n = 139)	2	42	30.2%
	1	27	19.4%
	0	70	50.4%

Note. Due to missing values on demographics questions, frequencies within groups may not add up to the total number of responses.

Plots

All plots are generated from **Model A2**.

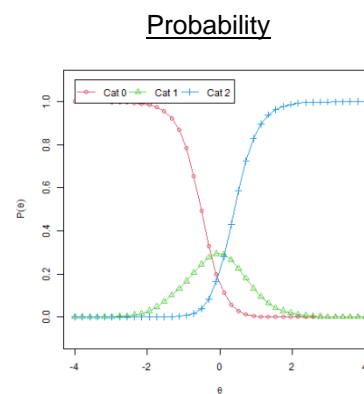
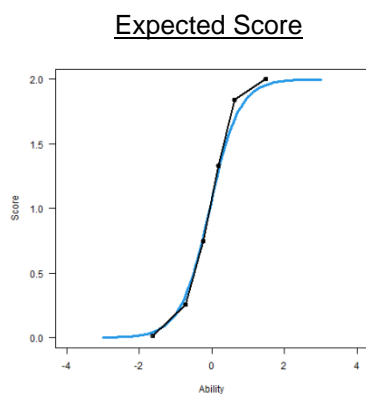
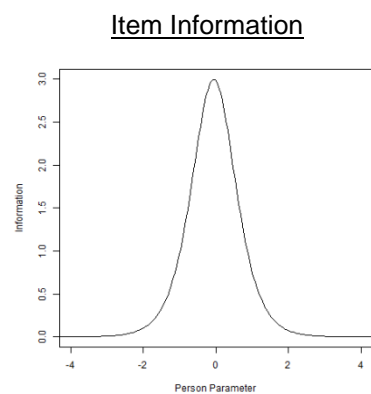

Note. The blue line represents expected performance, and the black line represents actual performance.

Note. Cat n = probability of receiving n points.

4.2.5. Calculations With Exponents (P5)

Rechnen mit Potenzen

Vervollständigen Sie die Formeln mit den entsprechenden Rechenzeichen für $a > 0$, $a \neq 1$ und $m, n \in \mathbb{N}$.

Wählen Sie jeweils die richtige Operation, die die Formel ergänzt.

a)

$$a^n \cdot a^m = a^n \square m$$

A + B - C * D / E Keine Eingabe möglich

b)

$$a^n - a^m = a^n \square m$$

A + B - C * D / E Keine Eingabe möglich

c)

$$(a^n)^m = a^n \square m$$

A + B - C * D / E Keine Eingabe möglich

Math Problem ID

P5

Correct Answers and Answer Frequencies

Math Problem Part	Correct Answer	Number Correct Answers	Number Incorrect Answers ^a	Answer Frequencies				
				A	B	C	D	E
a)	blinded	blinded	blinded	blinded	blinded	blinded	blinded	blinded
b)	blinded	blinded	blinded	blinded	blinded	blinded	blinded	blinded
c)	blinded	blinded	blinded	blinded	blinded	blinded	blinded	blinded

Note. Scoring (PCS4): Every correct response is worth one point (up to 3 points possible).

^a Includes cases, where the problem was seen but not answered.

Item Characteristics

Discrimination					
Measurement Type		Model A2	Model B	Model C	Model D
Correlation to participant ability (θ)		0.73	0.66	0.66	0.67
Discrimination Parameter (α)		1.54	1.42	1.18	1.55
Discrimination (Detailed)					
Measurement Type	Points	Model A2	Model B	Model C	Model D
Difficulty for participant of average ability level	3	-0.13	-0.15	-0.29	-0.14
	2	-1.16	-1.18	-1.46	-1.16
	1	-1.71	-1.73	-2.23	-1.70
	0	NA	NA	NA	NA
Cumulative probability for participant of average ability level	3	55.7%	56.3%	59.9%	56.2%
	2	94.7%	94.3%	94.5%	94.9%
	1	99.4%	99.3%	99.5%	99.5%
	0	100%	100%	100%	100%
Frequencies					
Groups	Points	Frequencies		Percent (%)	
Complete sample for this math problem (n = 544)	3	288		52.9%	
	2	165		30.3%	
	1	51		9.4%	
	0	40		7.4%	
Female (n = 169)	3	71		42.0%	
	2	65		38.5%	
	1	17		10.1%	
	0	16		9.5%	
Male (n = 369)	3	213		57.7%	
	2	100		27.1%	
	1	33		8.9%	
	0	23		6.2%	
German as primary language at home (n = 405)	3	211		52.1%	
	2	128		31.6%	
	1	38		9.4%	
	0	28		6.9%	
Other language as primary language at home (n = 133)	3	73		54.9%	
	2	37		27.8%	
	1	12		9.0%	
	0	11		8.3%	
Secondary school completed in Germany (n = 488)	3	245		50.2%	
	2	155		31.8%	
	1	49		10.0%	
	0	39		8.0%	

Frequencies			
Groups	Points	Frequencies	Percent (%)
Secondary school completed abroad (n = 51)	3	40	78.4%
	2	10	19.6%
	1	1	2.0%
	0	0	0.0%
Math not attended as advanced course in secondary school (n = 195)	3	58	29.7%
	2	74	37.9%
	1	35	17.9%
	0	28	14.4%
Math attended as advanced course in secondary school (n = 303)	3	197	65.0%
	2	84	27.7%
	1	14	4.6%
	0	8	2.6%
No math preparatory course attended (n = 252)	3	107	42.5%
	2	89	35.3%
	1	27	10.7%
	0	29	11.5%
Math preparatory course attended (n = 285)	3	177	62.1%
	2	75	26.3%
	1	23	8.1%
	0	10	3.5%
University of applied sciences (n = 137)	3	42	30.7%
	2	51	37.2%
	1	23	16.8%
	0	21	15.3%
University (n = 407)	3	246	60.4%
	2	114	28.0%
	1	28	6.9%
	0	19	4.7%
Online Participation (n = 367)	3	183	49.9%
	2	114	31.1%
	1	39	10.6%
	0	31	8.4%
Pen-and-Paper Participation (n = 177)	3	105	59.3%
	2	51	28.8%
	1	12	6.8%
	0	9	5.1%
Attended Gymnasium (n = 396)	3	230	58.1%
	2	124	31.3%
	1	27	6.8%
	0	15	3.8%
Attended Other Secondary School (n = 138)	3	52	37.7%
	2	39	28.3%
	1	23	16.7%
	0	24	17.4%

Note. Due to missing values on demographics questions, frequencies within groups may not add up to the total number of responses.

Plots

All plots are generated from **Model A2**.

Item Information

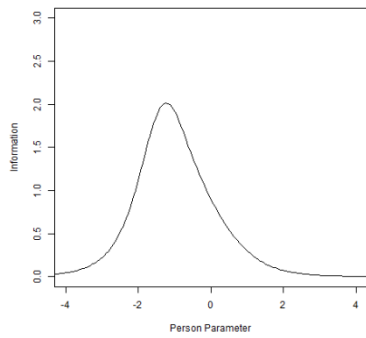

Expected Score

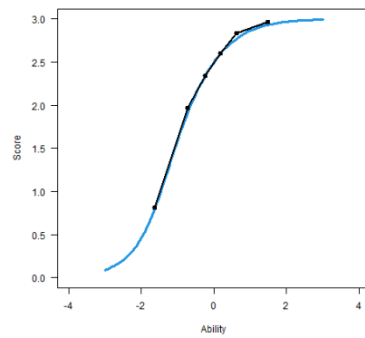

Probability

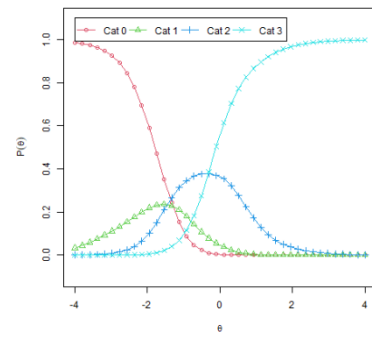

Note. The blue line represents expected performance, and the black line represents actual performance.

Note. Cat n = probability of receiving n points.

4.2.6. Compound Interest (P6)

Zinseszins

Ein Guthaben von 2000€ wird zu einem jährlichen Zinssatz von 1% angelegt. Welcher Betrag befindet sich nach 2 Jahren auf dem Sparkonto?
Geben Sie die Lösung auf **eine Nachkommastelle** gerundet an.

Ergänzen Sie das freie Feld.

Das Guthaben beträgt nach 2 Jahren €.

Math Problem ID

P6

Correct Answers and Answer Frequencies

Correct Answer(s)	Number Correct Answers	Number Incorrect Answers
blinded	blinded	blinded

Note. Scoring (PCS4): Every correct response is worth one point (up to 1 point possible).

Item Characteristics

Discrimination					
Measurement Type		Model A2	Model B	Model C	Model D
Correlation to participant ability (θ)		0.44	0.37	0.36	0.38
Discrimination Parameter (α)		0.90	0.82	0.65	0.85
Difficulty					
Measurement Type	Points	Model A2	Model B	Model C	Model D
Difficulty for participant of average ability level	1	-0.62	-0.68	-0.95	-0.66
	0	NA	NA	NA	NA
Cumulative probability for participant of average ability level	1	63.6%	63.5%	64.9%	63.6%
	0	100%	100%	100%	100%
Frequencies					
Groups	Points	Frequencies		Percent (%)	
Complete sample for this math problem (n = 592)	1	363		61.3%	
	0	229		38.7%	
Female (n = 189)	1	95		50.3%	
	0	94		49.7%	
Male (n = 394)	1	262		66.5%	
	0	132		33.5%	
German as primary language at home (n = 441)	1	278		63.0%	
	0	163		37.0%	

Frequencies			
Groups	Points	Frequencies	Percent (%)
Other language as primary language at home (n = 144)	1	81	56.3%
	0	63	43.8%
Secondary school completed in Germany (n = 524)	1	322	61.5%
	0	202	38.5%
Secondary school completed abroad (n = 62)	1	37	59.7%
	0	25	40.3%
Math not attended as advanced course in secondary school (n = 218)	1	108	49.5%
	0	110	50.5%
Math attended as advanced course in secondary school (n = 321)	1	220	68.5%
	0	101	31.5%
No math preparatory course attended (n = 262)	1	139	53.1%
	0	123	46.9%
Math preparatory course attended (n = 320)	1	216	67.5%
	0	104	32.5%
University of applied sciences (n = 147)	1	69	46.9%
	0	78	53.1%
University (n = 445)	1	294	66.1%
	0	151	33.9%
Online Participation (n = 413)	1	243	58.8%
	0	170	41.2%
Pen-and-Paper Participation (n = 179)	1	120	67.0%
	0	59	33.0%
Attended Gymnasium (n = 424)	1	281	66.3%
	0	143	33.7%
Attended Other Secondary School (n = 153)	1	73	47.7%
	0	80	52.3%

Note. Due to missing values on demographics questions, frequencies within groups may not add up to the total number of responses.

Plots

All plots are generated from **Model A2**.

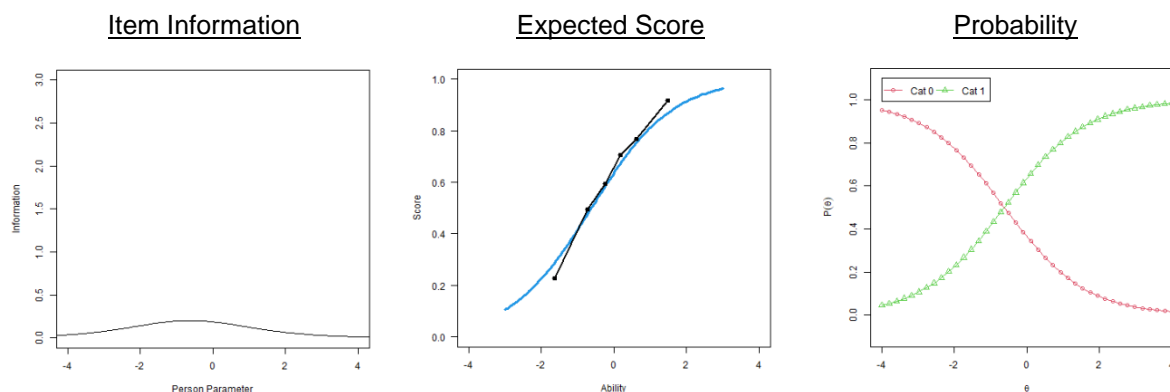

Note. The blue line represents expected performance, and the black line represents actual performance.

Note. Cat n = probability of receiving n points.

4.2.7. Inverse Operations (P7)

Umkehroperationen

Welche Operationen benötigt man zur Bestimmung der Unbekannten?

Wählen Sie jeweils die richtige Antwort.

a)

$x^3 = 8$

b)

$3^x = 8$

Math Problem ID

P7

Answer Options

Answer Code	Answer Text
A	achte Wurzel
B	dritte Wurzel
C	Potenzierung mit 3
D	Potenzierung mit -3
E	Logarithmus zur Basis 3
F	Logarithmus zur Basis 10
G	Logarithmus zur Basis 8
H	Subtraktion von 8

Correct Answers and Answer Frequencies

Math Problem Part	Correct Answer	Number Correct Answers	Number Incorrect Answers ^a	Answer Frequencies							
				A	B	C	D	E	F	G	H
a)	blinded	blinded	blinded	blinded	blinded
b)	blinded	blinded	blinded	blinded	blinded

Note. Scoring (PCS4): Every correct response is worth one point (up to 2 points possible).

^a Includes cases, where the problem was seen but not answered.

Item Characteristics

Discrimination					
Measurement Type		Model A2	Model B	Model C	Model D
Correlation to participant ability (θ)		0.54	0.50	0.50	0.52
Discrimination Parameter (α)		1.06	1.15	0.95	1.14
Difficulty					
Measurement Type	Points	Model A2	Model B	Model C	Model D
Difficulty for participant of average ability level	2	-1.02	-0.99	-1.30	-1.00
	1	-2.39	-2.28	-2.93	-2.31
	0	NA	NA	NA	NA
Cumulative probability for participant of average ability level	2	77.8%	78.7%	80.2%	78.7%
	1	97.9%	98.2%	98.6%	98.2%
	0	100%	100%	100%	100%
Frequencies					
Groups	Points	Frequencies	Percent (%)		
Complete sample for this math problem (n = 586)	2	420	71.7%		
	1	129	22.0%		
	0	37	6.3%		
Female (n = 188)	2	126	67.0%		
	1	42	22.3%		
	0	20	10.6%		
Male (n = 389)	2	288	74.0%		
	1	85	21.9%		
	0	16	4.1%		
German as primary language at home (n = 435)	2	322	74.0%		
	1	89	20.5%		
	0	24	5.5%		
Other language as primary language at home (n = 144)	2	94	65.3%		
	1	38	26.4%		
	0	12	8.3%		
Secondary school completed in Germany (n = 518)	2	376	72.6%		
	1	109	21.0%		
	0	33	6.4%		
Secondary school completed abroad (n = 62)	2	41	66.1%		
	1	18	29.0%		
	0	3	4.8%		
Math not attended as advanced course in secondary school (n = 214)	2	122	57.0%		
	1	64	29.9%		
	0	28	13.1%		
Math attended as advanced course in secondary school (n = 319)	2	264	82.8%		
	1	50	15.7%		
	0	5	1.6%		

Frequencies			
Groups	Points	Frequencies	Percent (%)
No math preparatory course attended (n = 259)	2	170	65.6%
	1	63	24.3%
	0	26	10.0%
Math preparatory course attended (n = 318)	2	245	77.0%
	1	63	19.8%
	0	10	3.1%
University of applied sciences (n = 146)	2	77	52.7%
	1	50	34.2%
	0	19	13.0%
University (n = 440)	2	343	78.0%
	1	79	18.0%
	0	18	4.1%
Online Participation (n = 407)	2	280	68.8%
	1	93	22.9%
	0	34	8.4%
Pen-and-Paper Participation (n = 179)	2	140	78.2%
	1	36	20.1%
	0	3	1.7%
Attended Gymnasium (n = 420)	2	327	77.9%
	1	75	17.9%
	0	18	4.3%
Attended Other Secondary School (n = 151)	2	85	56.3%
	1	50	33.1%
	0	16	10.6%

Note. Due to missing values on demographics questions, frequencies within groups may not add up to the total number of responses.

Plots

All plots are generated from **Model A2**.

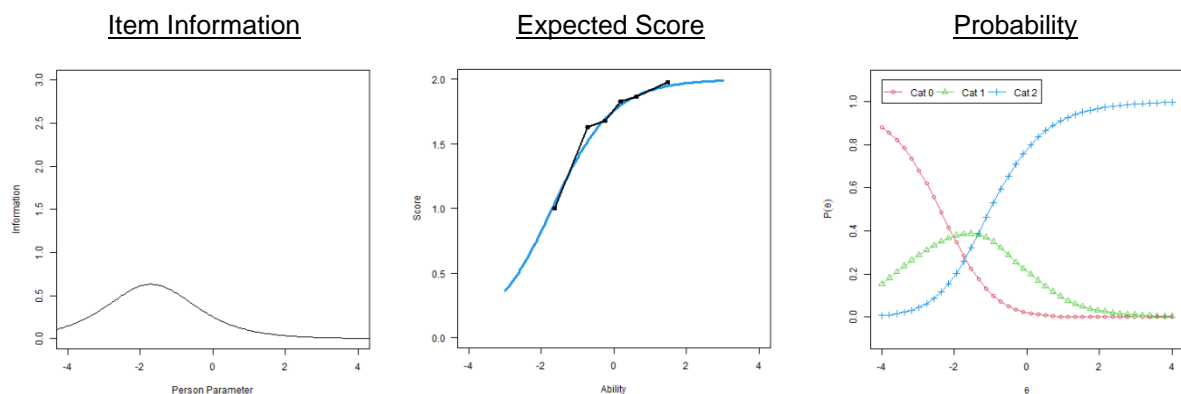

Note. The blue line represents expected performance, and the black line represents actual performance.

Note. Cat n = probability of receiving n points.

4.2.8. Equation With Exponents (P8)

Gleichung mit Exponenten

Lösen Sie die Gleichung nach $x \in \mathbb{R}$ auf.

Ergänzen Sie das freie Feld.

Beachten Sie: Nutzen Sie zum Ausdruck von Brüchen das Zeichen / (Division).

$$2^{5x-1} = 8 \iff x = \text{[]}$$

Math Problem ID

P8

Correct Answers and Answer Frequencies

Correct Answer(s)	Number Correct Answers	Number Incorrect Answers
blinded	blinded	blinded

Note. Scoring (PCS4): Every correct response is worth one point (up to 1 point possible).

Item Characteristics

Discrimination					
Measurement Type		Model A2	Model B	Model C	Model D
Correlation to participant ability (θ)		0.62	0.57	0.57	0.57
Discrimination Parameter (α)		1.73	1.64	1.38	1.73
Difficulty					
Measurement Type	Points	Model A2	Model B	Model C	Model D
Difficulty for participant of average ability level	1	0.13	0.12	0.02	0.12
	0	NA	NA	NA	NA
Cumulative probability for participant of average ability level	1	44.3%	45.0%	49.2%	44.8%
	0	100%	100%	100%	100%
Frequencies					
Groups	Points	Frequencies		Percent (%)	
Complete sample for this math problem (n = 539)	1	253		46.9%	
	0	286		53.1%	
Female (n = 169)	1	58		34.3%	
	0	111		65.7%	
Male (n = 364)	1	193		53.0%	
	0	171		47.0%	

Frequencies			
Groups	Points	Frequencies	Percent (%)
German as primary language at home (n = 400)	1	169	42.3%
	0	231	57.8%
Other language as primary language at home (n = 133)	1	83	62.4%
	0	50	37.6%
Secondary school completed in Germany (n = 483)	1	210	43.5%
	0	273	56.5%
Secondary school completed abroad (n = 51)	1	42	82.4%
	0	9	17.6%
Math not attended as advanced course in secondary school (n = 192)	1	56	29.2%
	0	136	70.8%
Math attended as advanced course in secondary school (n = 301)	1	165	54.8%
	0	136	45.2%
No math preparatory course attended (n = 251)	1	105	41.8%
	0	146	58.2%
Math preparatory course attended (n = 281)	1	146	52.0%
	0	135	48.0%
University of applied sciences (n = 137)	1	33	24.1%
	0	104	75.9%
University (n = 402)	1	220	54.7%
	0	182	45.3%
Online Participation (n = 362)	1	178	49.2%
	0	184	50.8%
Pen-and-Paper Participation (n = 177)	1	75	42.4%
	0	102	57.6%
Attended Gymnasium (n = 393)	1	200	50.9%
	0	193	49.1%
Attended Other Secondary School (n = 136)	1	48	35.3%
	0	88	64.7%

Note. Due to missing values on demographics questions, frequencies within groups may not add up to the total number of responses.

Plots

All plots are generated from **Model A2**.

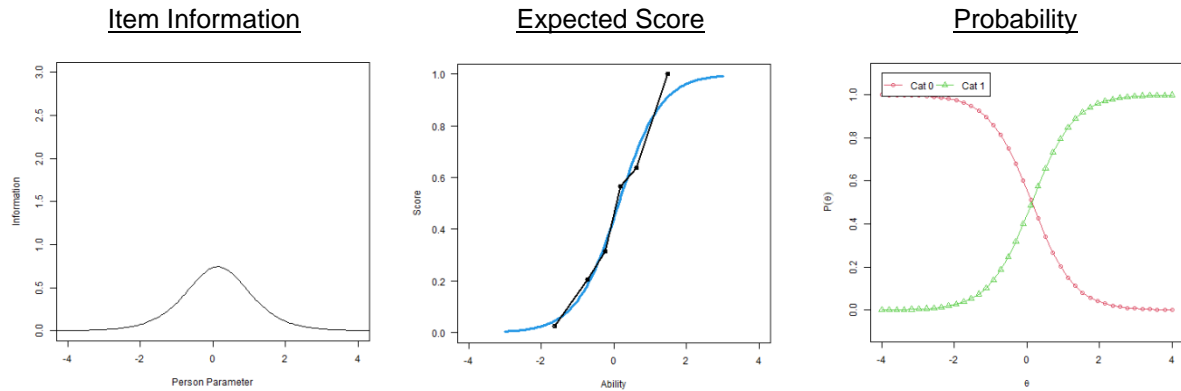

Note. The blue line represents expected performance, and the black line represents actual performance.

Note. Cat n = probability of receiving n points.

Differential Item Functioning (DIF)

This problem shows DIF across primary language. The difficulty (β) parameter was significantly lower for those who spoke a different language than German as their primary language at home. Meanwhile, the discrimination (α) parameter was significantly higher for those who spoke a different language than German at home. This shows that the problem was significantly harder and less informative for those who spoke German at home.

Expected Score (German as primary language)

Expected Score (other primary language)

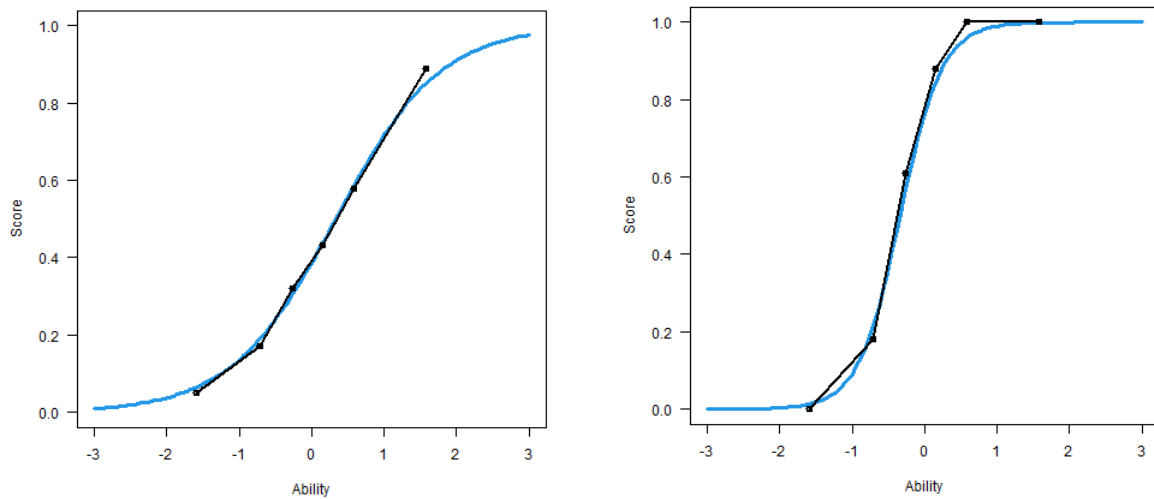

Note. The blue line represents expected performance, and the black line represents actual performance.

4.2.9. Root Equations (P9)

Wurzelgleichungen

Geben Sie die Lösung an.

Ergänzen Sie das freie Feld.

$$\sqrt{2x + 8} = 4 \iff x = \text{[]}$$

Math Problem ID

P9

Correct Answers and Answer Frequencies

Correct Answer(s)	Number Correct Answers	Number Incorrect Answers
blinded	blinded	blinded

Note. Scoring (PCS4): Every correct response is worth one point (up to 1 point possible).

Item Characteristics

Discrimination					
Measurement Type		Model A2	Model B	Model C	Model D
Correlation to participant ability (θ)		0.61	0.54	0.54	0.54
Discrimination Parameter (α)		2.00	1.87	1.47	1.99
Difficulty					
Measurement Type	Points	Model A2	Model B	Model C	Model D
Difficulty for participant of average ability level	1	-0.86	-0.89	-1.17	-0.87
	0	NA	NA	NA	NA
Cumulative probability for participant of average ability level	1	84.7%	84.2%	84.9%	84.8%
	0	100%	100%	100%	100%
Frequencies					
Groups	Points	Frequencies		Percent (%)	
Complete sample for this math problem (n = 537)	1	402		74.9%	
	0	135		25.1%	
Female (n = 168)	1	112		66.7%	
	0	56		33.3%	
Male (n = 363)	1	286		78.8%	
	0	77		21.2%	
German as primary language at home (n = 398)	1	294		73.9%	
	0	104		26.1%	

Frequencies			
Groups	Points	Frequencies	Percent (%)
Other language as primary language at home (n = 133)	1	104	78.2%
	0	29	21.8%
Secondary school completed in Germany (n = 481)	1	353	73.4%
	0	128	26.6%
Secondary school completed abroad (n = 51)	1	46	90.2%
	0	5	9.8%
Math not attended as advanced course in secondary school (n = 191)	1	107	56.0%
	0	84	44.0%
Math attended as advanced course in secondary school (n = 300)	1	259	86.3%
	0	41	13.7%
No math preparatory course attended (n = 250)	1	166	66.4%
	0	84	33.6%
Math preparatory course attended (n = 280)	1	231	82.5%
	0	49	17.5%
University of applied sciences (n = 136)	1	71	52.2%
	0	65	47.8%
University (n = 401)	1	331	82.5%
	0	70	17.5%
Online Participation (n = 360)	1	269	74.7%
	0	91	25.3%
Pen-and-Paper Participation (n = 177)	1	133	75.1%
	0	44	24.9%
Attended Gymnasium (n = 392)	1	316	80.6%
	0	76	19.4%
Attended Other Secondary School (n = 135)	1	78	57.8%
	0	57	42.2%

Note. Due to missing values on demographics questions, frequencies within groups may not add up to the total number of responses.

Plots

All plots are generated from **Model A2**.

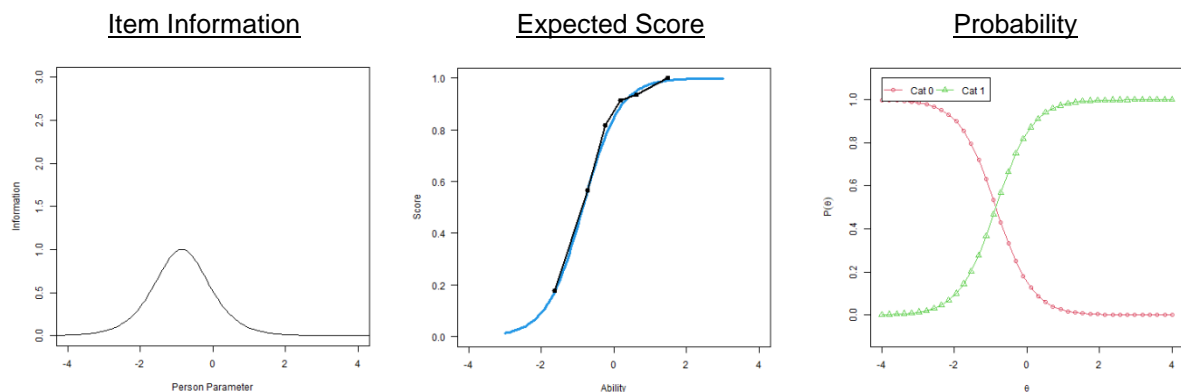

Note. The blue line represents expected performance, and the black line represents actual performance.

Note. Cat n = probability of receiving n points.

4.2.10. Laws of Logarithms (P10)

Logarithmusgesetze

Welche dieser Gleichungen gelten für alle $a > 0, b > 0$?

Wählen Sie eine oder mehrere richtige Antworten.

$\log_2(a \cdot b) = \log_2(a) + \log_2(b)$

$\log_a(b) = \log_b(a)$

$\log_a(2 \cdot a) = 2$

$\log_a\left(\frac{1}{b}\right) = -\log_a(b)$

Math Problem ID

P10

Correct Answers and Answer Frequencies

Answer	Correct Answer(s)	Number Correct Answers	Number Incorrect Answers
$\log_2(a \cdot b) = \log_2(a) + \log_2(b)$	blinded	blinded	blinded
$\log_a(b) = \log_b(a)$	blinded	blinded	blinded
$\log_a(2 \cdot a) = 2$	blinded	blinded	blinded
$\log_a\left(\frac{1}{b}\right) = -\log_a(b)$	blinded	blinded	blinded

Note. Scoring (PCS4): Every correct response and correct rejection is worth one point (up to 4 points possible).

Item Characteristics

Discrimination					
Measurement Type		Model A2	Model B	Model C	Model D
Correlation to participant ability (θ)		0.61	0.57	0.57	0.59
Discrimination Parameter (α)		0.53	0.58	0.54	0.60
Difficulty					
Measurement Type	Points	Model A2	Model B	Model C	Model D
Difficulty for participant of average ability level	4	0.68	0.62	0.59	0.61
	3	-0.37	-0.37	-0.54	-0.36
	2	-1.12	-1.07	-1.42	-1.05
	1	-1.89	-1.78	-2.66	-1.77
	0	NA	NA	NA	NA
Cumulative probability for participant of average ability level	4	34.2%	34.4%	36.7%	34.2%
	3	61.0%	61.8%	65.0%	61.9%
	2	81.4%	82.4%	85.5%	82.6%
	1	91.5%	92.2%	95.8%	92.4%
	0	100%	100%	100%	100%
Frequencies					
Groups	Points	Frequencies		Percent (%)	
Complete sample for this math problem (n = 554)	4	197		35.6%	
	3	127		22.9%	
	2	97		17.5%	
	1	59		10.6%	
	0	74		13.4%	
Female (n = 174)	4	59		33.9%	
	3	35		20.1%	
	2	37		21.3%	
	1	15		8.6%	
	0	28		16.1%	
Male (n = 374)	4	135		36.1%	
	3	91		24.3%	
	2	60		16.0%	
	1	43		11.5%	
	0	45		12.0%	
German as primary language at home (n = 413)	4	137		33.2%	
	3	88		21.3%	
	2	80		19.4%	
	1	46		11.1%	
	0	62		15.0%	

Frequencies			
Groups	Points	Frequencies	Percent (%)
Other language as primary language at home (n = 136)	4	59	43.4%
	3	38	27.9%
	2	17	12.5%
	1	11	8.1%
	0	11	8.1%
Secondary school completed in Germany (n = 490)	4	160	32.7%
	3	111	22.7%
	2	93	19.0%
	1	54	11.0%
	0	72	14.7%
Secondary school completed abroad (n = 60)	4	36	60.0%
	3	15	25.0%
	2	4	6.7%
	1	4	6.7%
	0	1	1.7%
Math not attended as advanced course in secondary school (n = 198)	4	39	19.7%
	3	46	23.2%
	2	34	17.2%
	1	32	16.2%
	0	47	23.7%
Math attended as advanced course in secondary school (n = 311)	4	136	43.7%
	3	70	22.5%
	2	58	18.6%
	1	23	7.4%
	0	24	7.7%
No math preparatory course attended (n = 248)	4	68	27.4%
	3	53	21.4%
	2	47	19.0%
	1	35	14.1%
	0	45	18.1%
Math preparatory course attended (n = 299)	4	126	42.1%
	3	73	24.4%
	2	50	16.7%
	1	23	7.7%
	0	27	9.0%
University of applied sciences (n = 130)	4	26	20.0%
	3	40	30.8%
	2	24	18.5%
	1	19	14.6%
	0	21	16.2%
University (n = 424)	4	171	40.3%
	3	87	20.5%
	2	73	17.2%
	1	40	9.4%
	0	53	12.5%

Frequencies			
Groups	Points	Frequencies	Percent (%)
Online Participation (n = 375)	4	128	34.1%
	3	72	19.2%
	2	73	19.5%
	1	44	11.7%
	0	58	15.5%
Pen-and-Paper Participation (n = 179)	4	69	38.5%
	3	55	30.7%
	2	24	13.4%
	1	15	8.4%
	0	16	8.9%
Attended Gymnasium (n = 403)	4	161	40.0%
	3	89	22.1%
	2	69	17.1%
	1	34	8.4%
	0	50	12.4%
Attended Other Secondary School (n = 139)	4	31	22.3%
	3	35	25.2%
	2	28	20.1%
	1	23	16.5%
	0	22	15.8%

Note. Due to missing values on demographics questions, frequencies within groups may not add up to the total number of responses.

Plots

All plots are generated from **Model A2**.

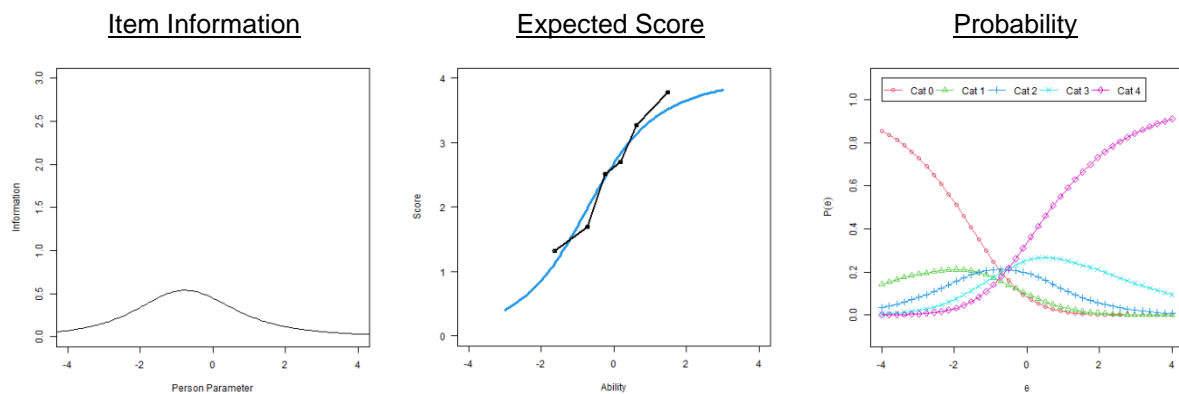

Note. The blue line represents expected performance, and the black line represents actual performance.

Note. Cat n = probability of receiving n points.

4.3. Terms and Equations (Terme und Gleichungen; TG)

Q₃ Statistics for Terms and Equations

	TG1	TG2	TG3	TG4	TG5	TG6	TG7	TG8	TG9	TG10
TG1	-									
TG2	.059	-								
TG3	-.021	.129	-							
TG4	-.182	-.182	-.082	-						
TG5	-.132	-.016	-.125	-.127	-					
TG6	-.045	-.052	-.025	-.098	-.133	-				
TG7	-.072	-.049	-.138	-.078	-.113	.008	-			
TG8	-.184	-.183	-.106	-.105	-.110	-.142	-.154	-		
TG9	-.068	-.125	.001	-.104	-.200	-.092	-.079	-.054	-	
TG10	.063	.122	.325	-.068	-.084	.003	-.109	-.165	.039	-

Note. Q₃ Statistics above the critical absolute value of 0.20 are bolded. For details see **Section 3.1**.

4.3.1. Binomial Formulas (TG1)

Binomische Formeln

Lösen Sie die Klammern auf.

Wählen Sie jeweils die richtige Antwort.

a)

$$\left(\frac{1}{2}x + 4y\right)^2 =$$

$\frac{1}{4}x^2 + 4xy + 16y^2$ A

$\frac{1}{2}x^2 + 4xy + 4y^2$ B

$\frac{1}{4}x^2 + 8xy + 16y^2$ C

$\frac{1}{4}x^2 + 16y^2$ D

b)

$$(2a - b) \cdot (2a + b) =$$

$4a^2 + b^2$ A

$4a^2 - b^2$ B

$4a^2 - 2ab - b^2$ C

$4a^2 + 4ab - b^2$ D

Math Problem ID

TG1

Correct Answers and Answer Frequencies

Math Problem Part	Correct Answer	Number Correct Answers	Number Incorrect Answers ^a	Answer Frequencies			
				A	B	C	D
a)	blinded	blinded	blinded	blinded	blinded	blinded	blinded
b)	blinded	blinded	blinded	blinded	blinded	blinded	blinded

Note. Scoring (PCS4): Every correct response is worth one point (up to 2 points possible).

^a Includes cases, where the problem was seen but not answered.

Item Characteristics

Discrimination					
Measurement Type		Model A3	Model B	Model C	Model D
Correlation to participant ability (θ)		0.64	0.57	0.58	0.57
Discrimination Parameter (α)		1.44	1.29	1.12	1.40
Difficulty					
Measurement Type	Points	Model A3	Model B	Model C	Model D
Difficulty for participant of average ability level	2	-0.42	-0.40	-0.55	-0.38
	1	-1.71	-1.77	-2.12	-1.70
	0	NA	NA	NA	NA
Cumulative probability for participant of average ability level	2	66.3%	64.1%	66.9%	64.7%
	1	96.9%	96.0%	96.7%	96.5%
	0	100%	100%	100%	100%
Frequencies					
Groups	Points	Frequencies		Percent (%)	
Complete sample for this math problem (n = 548)	2	338		61.7%	
	1	158		28.8%	
	0	52		9.5%	
Female (n = 182)	2	105		57.7%	
	1	60		33.0%	
	0	17		9.3%	
Male (n = 358)	2	227		63.4%	
	1	97		27.1%	
	0	34		9.5%	
German as primary language at home (n = 414)	2	243		58.7%	
	1	133		32.1%	
	0	38		9.2%	
Other language as primary language at home (n = 134)	2	95		70.9%	
	1	25		18.7%	
	0	14		10.4%	
Secondary school completed in Germany (n = 497)	2	292		58.8%	
	1	156		31.4%	
	0	49		9.9%	
Secondary school completed abroad (n = 49)	2	45		91.8%	
	1	1		2.0%	
	0	3		6.1%	
Math not attended as advanced course in secondary school (n = 188)	2	67		35.6%	
	1	79		42.0%	
	0	42		22.3%	
Math attended as advanced course in secondary school (n = 316)	2	236		74.7%	
	1	73		23.1%	
	0	7		2.2%	

Frequencies			
Groups	Points	Frequencies	Percent (%)
No math preparatory course attended (n = 237)	2	130	54.9%
	1	76	32.1%
	0	31	13.1%
Math preparatory course attended (n = 305)	2	203	66.6%
	1	81	26.6%
	0	21	6.9%
University of applied sciences (n = 135)	2	65	48.1%
	1	48	35.6%
	0	22	16.3%
University (n = 413)	2	273	66.1%
	1	110	26.6%
	0	30	7.3%
Online Participation (n = 380)	2	222	58.4%
	1	118	31.1%
	0	40	10.5%
Pen-and-Paper Participation (n = 168)	2	116	69.0%
	1	40	23.8%
	0	12	7.1%
Attended Gymnasium (n = 422)	2	275	65.2%
	1	117	27.7%
	0	30	7.1%
Attended Other Secondary School (n = 120)	2	59	49.2%
	1	40	33.3%
	0	21	17.5%

Note. Due to missing values on demographics questions, frequencies within groups may not add up to the total number of responses.

Plots

All plots are generated from **Model A3**.

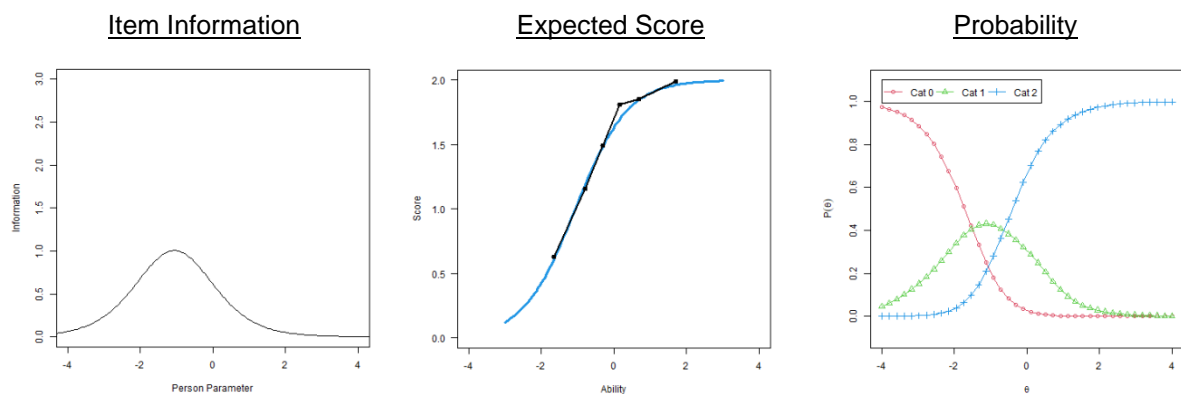

Note. The blue line represents expected performance, and the black line represents actual performance.

Note. Cat n = probability of receiving n points.

4.3.2. Simplifying Terms (TG2)

Terme vereinfachen

Vereinfachen Sie die folgenden Terme soweit wie möglich. Die Variablen a und b seien dabei stets so gewählt, dass die Terme definiert sind. Wenn man einen der Terme nicht vereinfachen kann, geben Sie den Buchstaben k ein.

Ergänzen Sie die freien Felder.

Schreibweise:
 Nutzen Sie folgende Zeichen: + (Addition), - (Subtraktion), * (Multiplikation), / (Division), ^ (Potenz), () Klammern.

$$\frac{8a + 12b}{4} = \text{[]}$$

$$\frac{a^2 - b^2}{2 \cdot (a - b)} = \text{[]}$$

Math Problem ID

TG2

Correct Answers and Answer Frequencies

Blank	Correct Answer(s)	Number Correct Answers	Number Incorrect Answers
1	blinded	blinded	blinded
2	blinded	blinded	blinded

Note. Scoring (PCS4): Every correct response is worth one point (up to 2 points possible).

Item Characteristics

Discrimination					
Measurement Type		Model A3	Model B	Model C	Model D
Correlation to participant ability (θ)		0.74	0.60	0.61	0.61
Discrimination Parameter (α)		1.67	1.21	1.08	1.42
Difficulty					
Measurement Type	Points	Model A3	Model B	Model C	Model D
Difficulty for participant of average ability level	2	0.88	1.07	1.11	0.99
	1	-1.03	-1.16	-1.40	-1.07
	0	NA	NA	NA	NA
Cumulative probability for participant of average ability level	2	16.8%	18.8%	20.8%	17.4%
	1	86.8%	83.0%	84.8%	84.4%
	0	100%	100%	100%	100%

Frequencies			
Groups	Points	Frequencies	Percent (%)
Complete sample for this math problem (n = 544)	2	144	26.5%
	1	284	52.2%
	0	116	21.3%
Female (n = 182)	2	45	24.7%
	1	88	48.4%
	0	49	26.9%
Male (n = 354)	2	96	27.1%
	1	193	54.5%
	0	65	18.4%
German as primary language at home (n = 411)	2	90	21.9%
	1	232	56.4%
	0	89	21.7%
Other language as primary language at home (n = 133)	2	54	40.6%
	1	52	39.1%
	0	27	20.3%
Secondary school completed in Germany (n = 493)	2	113	22.9%
	1	269	54.6%
	0	111	22.5%
Secondary school completed abroad (n = 49)	2	29	59.2%
	1	15	30.6%
	0	5	10.2%
Math not attended as advanced course in secondary school (n = 186)	2	25	13.4%
	1	94	50.5%
	0	67	36.0%
Math attended as advanced course in secondary school (n = 314)	2	96	30.6%
	1	176	56.1%
	0	42	13.4%
No math preparatory course attended (n = 234)	2	52	22.2%
	1	124	53.0%
	0	58	24.8%
Math preparatory course attended (n = 304)	2	88	28.9%
	1	160	52.6%
	0	56	18.4%
University of applied sciences (n = 135)	2	28	20.7%
	1	64	47.4%
	0	43	31.9%
University (n = 409)	2	116	28.4%
	1	220	53.8%
	0	73	17.8%
Online Participation (n = 376)	2	96	25.5%
	1	197	52.4%
	0	83	22.1%
Pen-and-Paper Participation (n = 168)	2	48	28.6%
	1	87	51.8%
	0	33	19.6%

Frequencies			
Groups	Points	Frequencies	Percent (%)
Attended Gymnasium (n = 419)	2	117	27.9%
	1	225	53.7%
	0	77	18.4%
Attended Other Secondary School (n = 119)	2	22	18.5%
	1	59	49.6%
	0	38	31.9%

Note. Due to missing values on demographics questions, frequencies within groups may not add up to the total number of responses.

Plots

All plots are generated from **Model A3**.

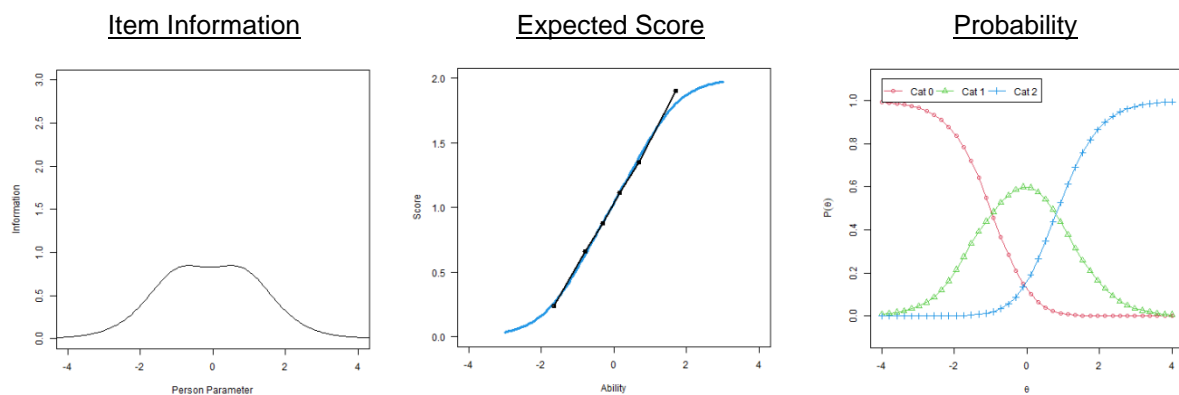

Note. The blue line represents expected performance, and the black line represents actual performance.

Note. Cat n = probability of receiving n points.

Differential Item Functioning (DIF)

This problem shows DIF across primary language. The discrimination (α) parameter was significantly higher for those who spoke a different language than German at home. This shows that the problem is less informative for those who spoke German at home.

Expected Score (German as primary language)

Expected Score (other primary language)

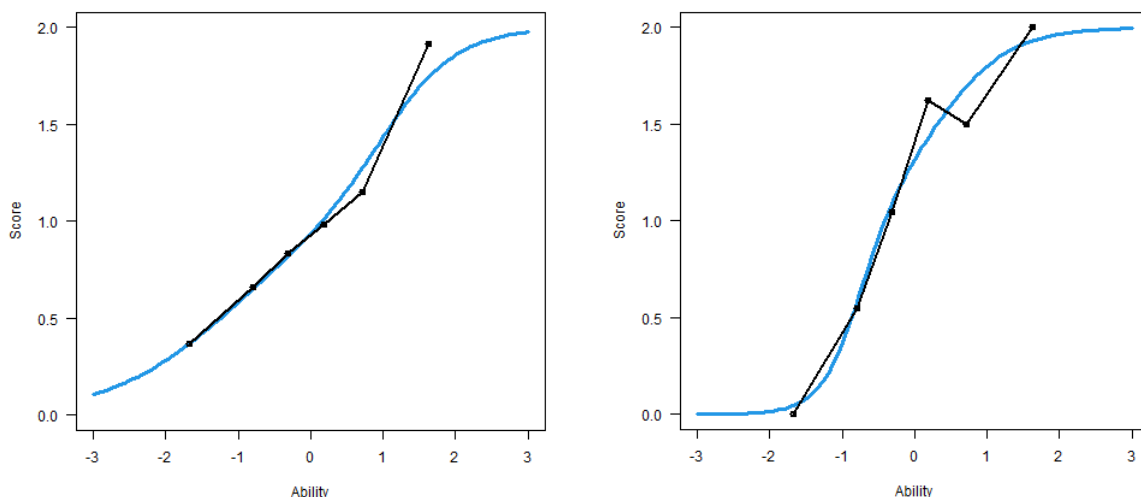

Note. The blue line represents expected performance, and the black line represents actual performance.

4.3.3. Volume of a Prism (TG3)

Volumen eines Prismas

Welcher Term beschreibt das Volumen des Prismas mit den Maßen a , b und c ?

Wählen Sie die richtige Antwort.

A $2a^2 - 2b^2 + 4ac$

B $2abc - 2b^2c$

C $2a^2c - 2abc$

D $a^2c - b^2c$

Math Problem ID

TG3

Correct Answers and Answer Frequencies

Correct Answer	Number Correct Answers	Number Incorrect Answers ^a	Answer Frequencies			
			A	B	C	D
blinded	blinded	blinded	blinded	blinded	blinded	blinded

Note. Scoring (PCS4): Every correct response is worth one point (up to 1 point possible).

^a Includes cases, where the problem was seen but not answered.

Item Characteristics

Discrimination					
Measurement Type		Model A3	Model B	Model C	Model D
Correlation to participant ability (θ)		0.59	0.54	0.55	0.56
Discrimination Parameter (α)		1.89	1.76	1.53	1.92
Difficulty					
Measurement Type	Points	Model A3	Model B	Model C	Model D
Difficulty for participant of average ability level	1	-0.77	-0.75	-0.94	-0.72
	0	NA	NA	NA	NA
Cumulative probability for participant of average ability level	1	80.9%	78.9%	80.9%	79.9%
	0	100%	100%	100%	100%

Frequencies			
Groups	Points	Frequencies	Percent (%)
Complete sample for this math problem (n = 540)	1	393	72.8%
	0	147	27.2%
Female (n = 179)	1	121	67.6%
	0	58	32.4%
Male (n = 353)	1	266	75.4%
	0	87	24.6%
German as primary language at home (n = 408)	1	308	75.5%
	0	100	24.5%
Other language as primary language at home (n = 132)	1	85	64.4%
	0	47	35.6%
Secondary school completed in Germany (n = 489)	1	354	72.4%
	0	135	27.6%
Secondary school completed abroad (n = 49)	1	37	75.5%
	0	12	24.5%
Math not attended as advanced course in secondary school (n = 184)	1	97	52.7%
	0	87	47.3%
Math attended as advanced course in secondary school (n = 312)	1	261	83.7%
	0	51	16.3%
No math preparatory course attended (n = 234)	1	159	67.9%
	0	75	32.1%
Math preparatory course attended (n = 300)	1	231	77.0%
	0	69	23.0%
University of applied sciences (n = 134)	1	79	59.0%
	0	55	41.0%
University (n = 406)	1	314	77.3%
	0	92	22.7%
Online Participation (n = 374)	1	273	73.0%
	0	101	27.0%
Pen-and-Paper Participation (n = 166)	1	120	72.3%
	0	46	27.7%
Attended Gymnasium (n = 416)	1	324	77.9%
	0	92	22.1%
Attended Other Secondary School (n = 118)	1	64	54.2%
	0	54	45.8%

Note. Due to missing values on demographics questions, frequencies within groups may not add up to the total number of responses.

Plots

All plots are generated from **Model A3**.

Item Information

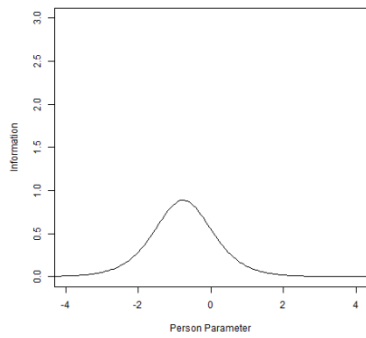

Expected Score

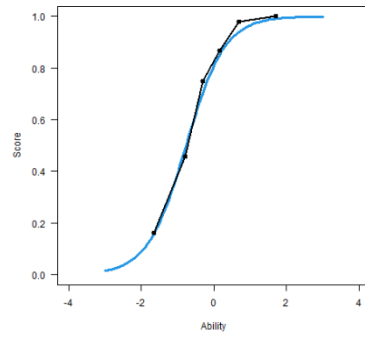

Note. The blue line represents expected performance, and the black line represents actual performance.

Probability

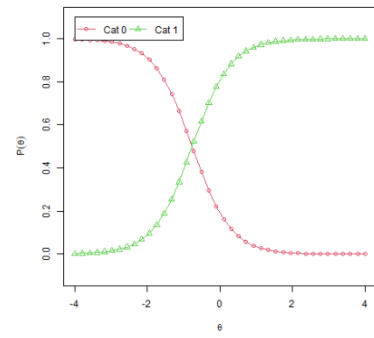

Note. Cat n = probability of receiving n points.

4.3.4. Equivalent Transformations (TG4)

Äquivalenzumformungen

Geben Sie an, ob die Äquivalenzumformungen korrekt durchgeführt wurden.

Wählen Sie jeweils die richtige Antwort.

	Richtig	Falsch
$\frac{1}{3}x = 27 \iff x = 9$	<input type="radio"/>	<input type="radio"/>
$x^2 - 4x + 7 = 0 \iff (x - 2)^2 = -3$	<input type="radio"/>	<input type="radio"/>

Math Problem ID

TG4

Correct Answers and Answer Frequencies

Math Problem Part	Correct Answer(s)	Number Correct Answers	Number Incorrect Answers
1. Transformation	blinded	blinded	blinded
2. Transformation	blinded	blinded	blinded

Note. Scoring (PCS4): Every correct response is worth one point (up to 2 points possible).

Item Characteristics

Discrimination					
Measurement Type		Model A3	Model B	Model C	Model D
Correlation to participant ability (θ)		0.56	0.51	0.51	0.52
Discrimination Parameter (α)		0.91	0.88	0.82	0.94
Difficulty					
Measurement Type	Points	Model A3	Model B	Model C	Model D
Difficulty for participant of average ability level	2	-0.60	-0.53	-0.69	-0.53
	1	-1.84	-1.80	-2.20	-1.75
	0	NA	NA	NA	NA
Cumulative probability for participant of average ability level	2	66.5%	64.5%	66.8%	65.2%
	1	92.7%	91.7%	93.7%	92.3%
	0	100%	100%	100%	100%

Frequencies			
Groups	Points	Frequencies	Percent (%)
Complete sample for this math problem (n = 552)	2	339	61.4%
	1	139	25.2%
	0	74	13.4%
Female (n = 200)	2	110	55.0%
	1	57	28.5%
	0	33	16.5%
Male (n = 343)	2	224	65.3%
	1	81	23.6%
	0	38	11.1%
German as primary language at home (n = 411)	2	257	62.5%
	1	98	23.8%
	0	56	13.6%
Other language as primary language at home (n = 141)	2	82	58.2%
	1	41	29.1%
	0	18	12.8%
Secondary school completed in Germany (n = 494)	2	299	60.5%
	1	126	25.5%
	0	69	14.0%
Secondary school completed abroad (n = 57)	2	39	68.4%
	1	13	22.8%
	0	5	8.8%
Math not attended as advanced course in secondary school (n = 181)	2	78	43.1%
	1	55	30.4%
	0	48	26.5%
Math attended as advanced course in secondary school (n = 329)	2	229	69.6%
	1	77	23.4%
	0	23	7.0%
No math preparatory course attended (n = 245)	2	135	55.1%
	1	69	28.2%
	0	41	16.7%
Math preparatory course attended (n = 301)	2	201	66.8%
	1	68	22.6%
	0	32	10.6%
University of applied sciences (n = 137)	2	55	40.1%
	1	42	30.7%
	0	40	29.2%
University (n = 415)	2	284	68.4%
	1	97	23.4%
	0	34	8.2%
Online Participation (n = 388)	2	223	57.5%
	1	111	28.6%
	0	54	13.9%
Pen-and-Paper Participation (n = 164)	2	116	70.7%
	1	28	17.1%
	0	20	12.2%

Frequencies			
Groups	Points	Frequencies	Percent (%)
Attended Gymnasium (n = 425)	2	283	66.6%
	1	97	22.8%
	0	45	10.6%
Attended Other Secondary School (n = 121)	2	53	43.8%
	1	41	33.9%
	0	27	22.3%

Note. Due to missing values on demographics questions, frequencies within groups may not add up to the total number of responses.

Plots

All plots are generated from **Model A3**.

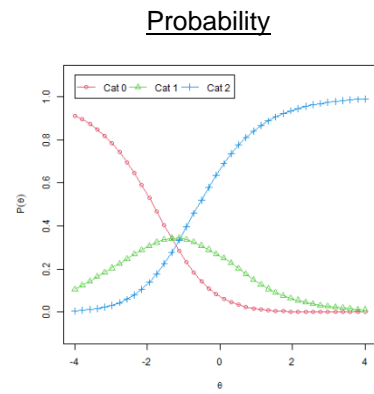
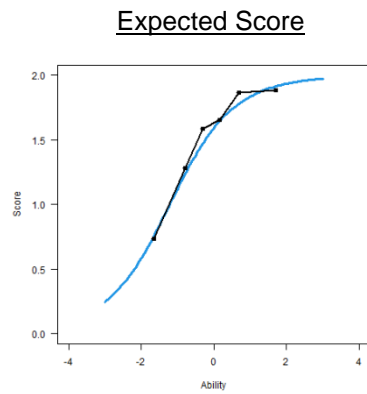
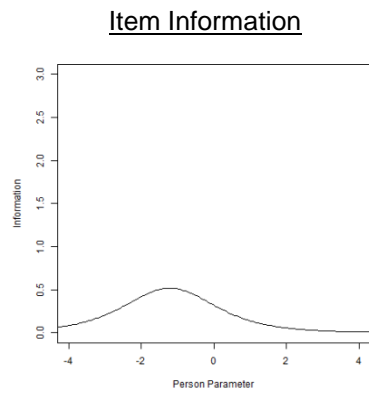

Note. The blue line represents expected performance, and the black line represents actual performance.

Note. Cat n = probability of receiving n points.

4.3.5. Simple Equations (TG5)

Einfache Gleichungen

Lösen Sie die folgenden Gleichungen nach x auf. Sollte keine Lösung existieren, geben Sie bitte den Buchstaben k ein.

Ergänzen Sie die freien Felder.

$$6 - 3x = 5x - 2 \iff x = \text{[]}$$

$$x^2 = 25 \iff x = \text{[]} \vee x = \text{[]}$$

$$2x^2 + 4x - 16 = 0 \iff x = \text{[]} \vee x = \text{[]}$$

Math Problem ID

TG5

Correct Answers and Answer Frequencies

Math Problem Part	Blank	Correct Answer(s)	Number Correct Answers	Number Incorrect Answers
1. Equation	1	blinded	blinded	blinded
2. Equation	1	blinded	blinded	blinded
	2	blinded	blinded	blinded
3. Equation	1	blinded	blinded	blinded
	2	blinded	blinded	blinded

Note. Scoring (PCS4): For each equation, all blanks must be answered correctly to earn one point (up to 3 points possible). The order in which the answers are given for Equations 2 and 3 is irrelevant.

Item Characteristics

Discrimination					
Measurement Type		Model A3	Model B	Model C	Model D
Correlation to participant ability (θ)		0.66	0.60	0.61	0.60
Discrimination Parameter (α)		1.15	1.05	1.04	1.13
Discrimination (continued)					
Measurement Type	Points	Model A3	Model B	Model C	Model D
Difficulty for participant of average ability level	3	-0.01	0.04	-0.05	0.03
	2	-1.25	-1.26	-1.49	-1.23
	1	-1.99	-2.03	-2.56	-1.98
	0	NA	NA	NA	NA
Cumulative probability for participant of average ability level	3	50.3%	48.7%	51.5%	48.8%
	2	91.4%	90.1%	91.9%	90.7%
	1	98.8%	98.4%	99.3%	98.6%
	0	100%	100%	100%	100%
Frequencies					
Groups	Points	Frequencies		Percent (%)	
Complete sample for this math problem (n = 539)	3	269		49.9%	
	2	180		33.4%	
	1	57		10.6%	
	0	33		6.1%	
Female (n = 179)	3	89		49.7%	
	2	59		33.0%	
	1	18		10.1%	
	0	13		7.3%	
Male (n = 352)	3	176		50.0%	
	2	118		33.5%	
	1	38		10.8%	
	0	20		5.7%	
German as primary language at home (n = 408)	3	199		48.8%	
	2	145		35.5%	
	1	45		11.0%	
	0	19		4.7%	
Other language as primary language at home (n = 131)	3	70		53.4%	
	2	35		26.7%	
	1	12		9.2%	
	0	14		10.7%	
Secondary school completed in Germany (n = 488)	3	238		48.8%	
	2	166		34.0%	
	1	53		10.9%	
	0	31		6.4%	

Frequencies			
Groups	Points	Frequencies	Percent (%)
Secondary school completed abroad (n = 49)	3	30	61.2%
	2	14	28.6%
	1	3	6.1%
	0	2	4.1%
Math not attended as advanced course in secondary school (n = 184)	3	57	31.0%
	2	69	37.5%
	1	30	16.3%
	0	28	15.2%
Math attended as advanced course in secondary school (n = 311)	3	188	60.5%
	2	98	31.5%
	1	22	7.1%
	0	3	1.0%
No math preparatory course attended (n = 234)	3	112	47.9%
	2	73	31.2%
	1	31	13.2%
	0	18	7.7%
Math preparatory course attended (n = 299)	3	154	51.5%
	2	106	35.5%
	1	25	8.4%
	0	14	4.7%
University of applied sciences (n = 134)	3	51	38.1%
	2	40	29.9%
	1	25	18.7%
	0	18	13.4%
University (n = 405)	3	218	53.8%
	2	140	34.6%
	1	32	7.9%
	0	15	3.7%
Online Participation (n = 373)	3	189	50.7%
	2	126	33.8%
	1	33	8.8%
	0	25	6.7%
Pen-and-Paper Participation (n = 166)	3	80	48.2%
	2	54	32.5%
	1	24	14.5%
	0	8	4.8%
Attended Gymnasium (n = 415)	3	213	51.3%
	2	143	34.5%
	1	42	10.1%
	0	17	4.1%
Attended Other Secondary School (n = 118)	3	52	44.1%
	2	36	30.5%
	1	14	11.9%
	0	16	13.6%

Note. Due to missing values on demographics questions, frequencies within groups may not add up to the total number of responses.

Plots

All plots are generated from **Model A3**.

Item Information

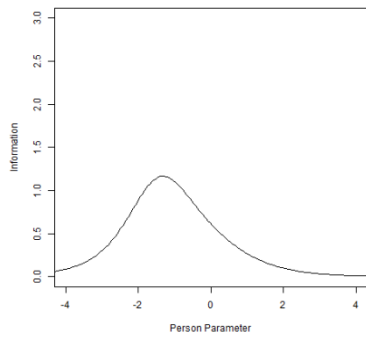

Expected Score

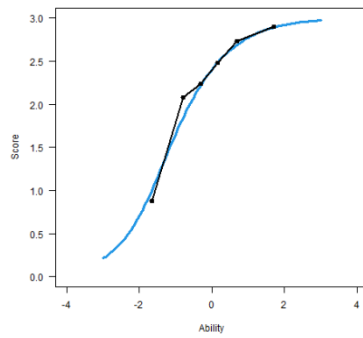

Probability

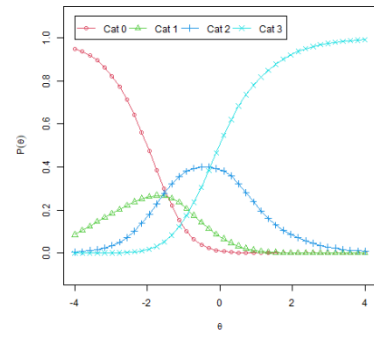

Note. The blue line represents expected performance, and the black line represents actual performance.

Note. Cat n = probability of receiving n points.

4.3.6. Equation With a Parameter (TG6)

Gleichung mit Parameter

Lösen Sie nach x auf.

Wählen Sie die richtige Antwort.

$(x - 6) \cdot (a - 3) = 10 \iff$

A $x = 6a - \frac{8}{3}$

B $x = \frac{10}{a - 3}$

C $x = \frac{6a - 8}{a - 3}$

D $x = 9 - \frac{8}{a}$

Math Problem ID

TG6

Correct Answers and Answer Frequencies

Correct Answer	Number Correct Answers	Number Incorrect Answers ^a	Answer Frequencies			
			A	B	C	D
blinded	blinded	blinded	blinded	blinded	blinded	blinded

Note. Scoring (PCS4): Every correct response is worth one point (up to 1 point possible).

^a Includes cases, where the problem was seen but not answered.

Item Characteristics

Discrimination					
Measurement Type		Model A3	Model B	Model C	Model D
Correlation to participant ability (θ)		0.52	0.45	0.45	0.47
Discrimination Parameter (α)		1.24	1.13	1.00	1.23
Difficulty					
Measurement Type	Points	Model A3	Model B	Model C	Model D
Difficulty for participant of average ability level	1	-0.90	-0.87	-1.09	-0.84
	0	NA	NA	NA	NA
Cumulative probability for participant of average ability level	1	75.3%	72.9%	74.9%	73.9%
	0	100%	100%	100%	100%
Frequencies					
Groups	Points	Frequencies		Percent (%)	
Complete sample for this math problem (n = 545)	1	378		69.4%	
	0	167		30.6%	
Female (n = 196)	1	141		71.9%	
	0	55		28.1%	

Frequencies			
Groups	Points	Frequencies	Percent (%)
Male (n = 340)	1	230	67.6%
	0	110	32.4%
German as primary language at home (n = 405)	1	280	69.1%
	0	125	30.9%
Other language as primary language at home (n = 140)	1	98	70.0%
	0	42	30.0%
Secondary school completed in Germany (n = 487)	1	328	67.4%
	0	159	32.6%
Secondary school completed abroad (n = 57)	1	49	86.0%
	0	8	14.0%
Math not attended as advanced course in secondary school (n = 179)	1	101	56.4%
	0	78	43.6%
Math attended as advanced course in secondary school (n = 324)	1	243	75.0%
	0	81	25.0%
No math preparatory course attended (n = 238)	1	150	63.0%
	0	88	37.0%
Math preparatory course attended (n = 301)	1	223	74.1%
	0	78	25.9%
University of applied sciences (n = 136)	1	76	55.9%
	0	60	44.1%
University (n = 409)	1	302	73.8%
	0	107	26.2%
Online Participation (n = 381)	1	258	67.7%
	0	123	32.3%
Pen-and-Paper Participation (n = 164)	1	120	73.2%
	0	44	26.8%
Attended Gymnasium (n = 419)	1	306	73.0%
	0	113	27.0%
Attended Other Secondary School (n = 120)	1	68	56.7%
	0	52	43.3%

Note. Due to missing values on demographics questions, frequencies within groups may not add up to the total number of responses.

Plots

All plots are generated from **Model A3**.

Item Information

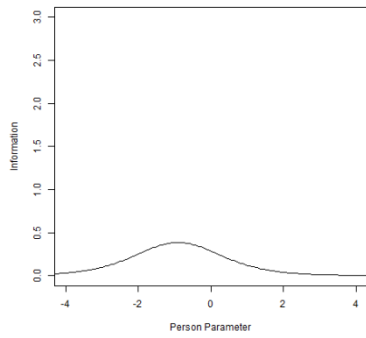

Expected Score

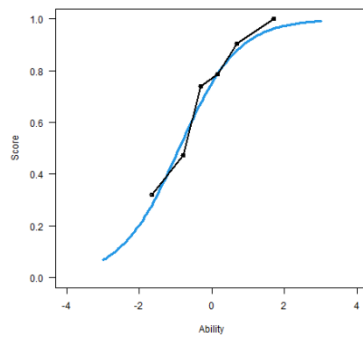

Probability

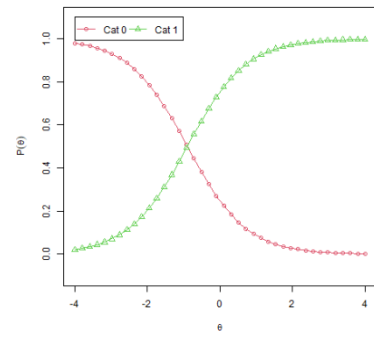

Note. The blue line represents expected performance, and the black line represents actual performance.

Note. Cat n = probability of receiving n points.

4.3.7. Fractional Equations (TG7)

Bruchgleichungen

Lösen Sie die Gleichung nach x auf. Werte von x , für welche der Term nicht definiert ist, sind ausgeschlossen.

Ergänzen Sie das freie Feld.

$$\frac{2x - 8}{x + 8} = -2 \iff x = \text{[]}$$

Math Problem ID

TG7

Correct Answers and Answer Frequencies

Correct Answer(s)	Number Correct Answers	Number Incorrect Answers
blinded	blinded	blinded

Note. Scoring (PCS4): Every correct response is worth one point (up to 1 point possible).

Item Characteristics

Discrimination					
Measurement Type		Model A3	Model B	Model C	Model D
Correlation to participant ability (θ)		0.51	0.42	0.42	0.44
Discrimination Parameter (α)		1.10	0.93	0.82	1.04
Difficulty					
Measurement Type	Points	Model A3	Model B	Model C	Model D
Difficulty for participant of average ability level	1	-0.32	-0.28	-0.42	-0.27
	0	NA	NA	NA	NA
Cumulative probability for participant of average ability level	1	58.8%	56.5%	58.5%	57.1%
	0	100%	100%	100%	100%
Frequencies					
Groups	Points	Frequencies		Percent (%)	
Complete sample for this math problem (n = 553)	1	310		56.1%	
	0	243		43.9%	
Female (n = 201)	1	108		53.7%	
	0	93		46.3%	
Male (n = 343)	1	196		57.1%	
	0	147		42.9%	
German as primary language at home (n = 412)	1	223		54.1%	
	0	189		45.9%	

Frequencies			
Groups	Points	Frequencies	Percent (%)
Other language as primary language at home (n = 141)	1	87	61.7%
	0	54	38.3%
Secondary school completed in Germany (n = 495)	1	265	53.5%
	0	230	46.5%
Secondary school completed abroad (n = 57)	1	44	77.2%
	0	13	22.8%
Math not attended as advanced course in secondary school (n = 182)	1	77	42.3%
	0	105	57.7%
Math attended as advanced course in secondary school (n = 329)	1	205	62.3%
	0	124	37.7%
No math preparatory course attended (n = 245)	1	132	53.9%
	0	113	46.1%
Math preparatory course attended (n = 302)	1	174	57.6%
	0	128	42.4%
University of applied sciences (n = 138)	1	61	44.2%
	0	77	55.8%
University (n = 415)	1	249	60.0%
	0	166	40.0%
Online Participation (n = 389)	1	218	56.0%
	0	171	44.0%
Pen-and-Paper Participation (n = 164)	1	92	56.1%
	0	72	43.9%
Attended Gymnasium (n = 425)	1	248	58.4%
	0	177	41.6%
Attended Other Secondary School (n = 122)	1	57	46.7%
	0	65	53.3%

Note. Due to missing values on demographics questions, frequencies within groups may not add up to the total number of responses.

Plots

All plots are generated from **Model A3**.

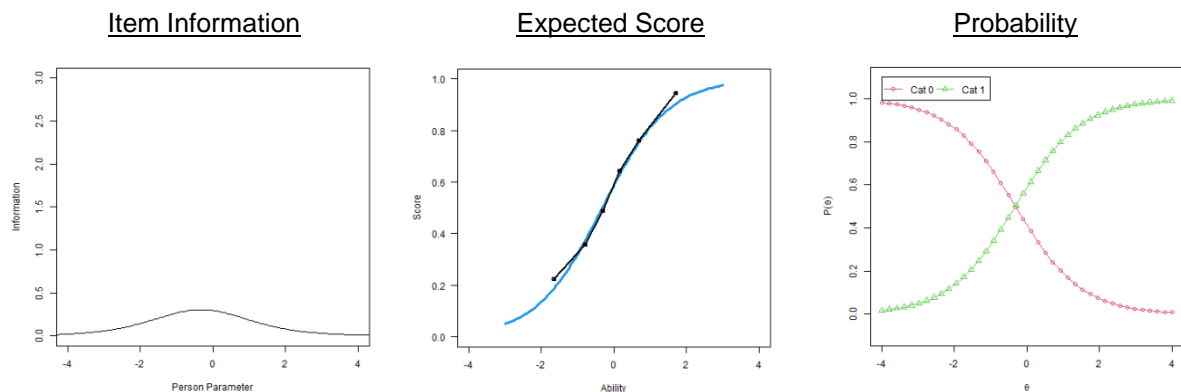

Note. The blue line represents expected performance, and the black line represents actual performance.

Note. Cat n = probability of receiving n points.

4.3.8. Graphical Representation of Solution Sets (TG8)

Graphische Darstellung von Lösungsmengen

Wählen Sie für jeden Zahlenstrahl jeweils diejenige Ungleichung, deren Lösungsmenge der Zahlenstrahl abbildet.

a)



A $x \leq -3$
B $x \leq 3$
C $x^2 \leq 9$
D $x \geq 3$
E $x \geq -3$
F $x^2 \geq 9$

b)



A $x \leq -3$
B $x \leq 3$
C $x^2 \leq 9$
D $x \geq 3$
E $x \geq -3$
F $x^2 \geq 9$

c)



A $x \leq -3$
B $x \leq 3$
C $x^2 \leq 9$
D $x \geq 3$
E $x \geq -3$
F $x^2 \geq 9$

Math Problem ID

TG8

Correct Answers and Answer Frequencies

Math Problem Part	Correct Answer	Number Correct Answers	Number Incorrect Answers ^a	Answer Frequencies					
				A	B	C	D	E	F
a)	blinded	blinded	blinded	blinded	blinded	blinded	blinded
b)	blinded	blinded	blinded	blinded	blinded	blinded	blinded
c)	blinded	blinded	blinded	blinded	blinded	blinded	blinded

Note. Scoring (PCS4): Every correct response is worth one point (up to 3 points possible).

^a Includes cases, where the problem was seen but not answered.

Item Characteristics

Discrimination					
Measurement Type		Model A3	Model B	Model C	Model D
Correlation to participant ability (θ)		0.59	0.52	0.53	0.53
Discrimination Parameter (α)		0.85	0.78	0.84	0.85
Difficulty					
Measurement Type	Points	Model A3	Model B	Model C	Model D
Difficulty for participant of average ability level	3	-0.08	-0.01	-0.10	-0.03
	2	-1.70	-1.70	-1.95	-1.65
	1	-2.32	-2.36	-3.08	-2.27
	0	NA	NA	NA	NA
Cumulative probability for participant of average ability level	3	52.1%	50.2%	52.5%	50.7%
	2	92.8%	91.6%	93.2%	92.3%
	1	98.3%	97.7%	99.3%	98.1%
	0	100%	100%	100%	100%
Frequencies					
Groups	Points	Frequencies	Percent (%)		
Complete sample for this math problem (n = 542)	3	269	49.6%		
	2	198	36.5%		
	1	42	7.7%		
	0	33	6.1%		
Female (n = 194)	3	84	43.3%		
	2	79	40.7%		
	1	19	9.8%		
	0	12	6.2%		
Male (n = 339)	3	183	54.0%		
	2	116	34.2%		
	1	22	6.5%		
	0	18	5.3%		
German as primary language at home (n = 402)	3	197	49.0%		
	2	151	37.6%		
	1	29	7.2%		
	0	25	6.2%		
Other language as primary language at home (n = 140)	3	72	51.4%		
	2	47	33.6%		
	1	13	9.3%		
	0	8	5.7%		
Secondary school completed in Germany (n = 484)	3	229	47.3%		
	2	187	38.6%		
	1	38	7.9%		
	0	30	6.2%		

Frequencies			
Groups	Points	Frequencies	Percent (%)
Secondary school completed abroad (n = 57)	3	39	68.4%
	2	11	19.3%
	1	4	7.0%
	0	3	5.3%
Math not attended as advanced course in secondary school (n = 178)	3	52	29.2%
	2	75	42.1%
	1	25	14.0%
	0	26	14.6%
Math attended as advanced course in secondary school (n = 322)	3	195	60.6%
	2	106	32.9%
	1	15	4.7%
	0	6	1.9%
No math preparatory course attended (n = 237)	3	104	43.9%
	2	88	37.1%
	1	27	11.4%
	0	18	7.6%
Math preparatory course attended (n = 299)	3	161	53.8%
	2	109	36.5%
	1	14	4.7%
	0	15	5.0%
University of applied sciences (n = 134)	3	41	30.6%
	2	60	44.8%
	1	15	11.2%
	0	18	13.4%
University (n = 408)	3	228	55.9%
	2	138	33.8%
	1	27	6.6%
	0	15	3.7%
Online Participation (n = 379)	3	207	54.6%
	2	114	30.1%
	1	33	8.7%
	0	25	6.6%
Pen-and-Paper Participation (n = 163)	3	62	38.0%
	2	84	51.5%
	1	9	5.5%
	0	8	4.9%
Attended Gymnasium (n = 418)	3	219	52.4%
	2	147	35.2%
	1	30	7.2%
	0	22	5.3%
Attended Other Secondary School (n = 118)	3	48	40.7%
	2	47	39.8%
	1	12	10.2%
	0	11	9.3%

Note. Due to missing values on demographics questions, frequencies within groups may not add up to the total number of responses.

Plots

All plots are generated from **Model A3**.

Item Information

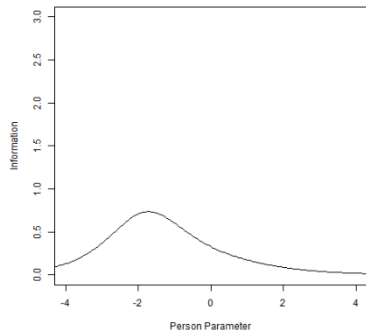

Expected Score

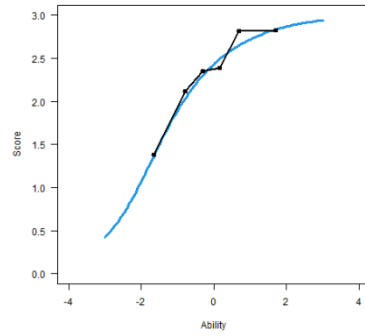

Note. The blue line represents expected performance, and the black line represents actual performance.

Probability

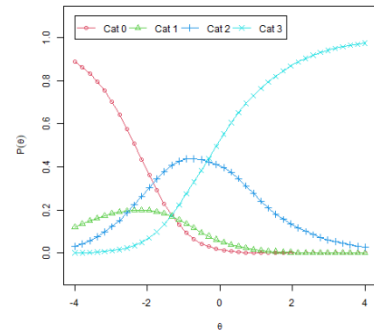

Note. Cat n = probability of receiving n points.

4.3.9. Sign Questions (TG9)

Vorzeichenfragen

Für welche der untenstehenden Bedingungen an $x \in \mathbb{R}$ ist folgender Zusammenhang erfüllt?

Wählen Sie eine oder mehrere richtige Antworten.

$$(x + 2) \cdot (x + 5) > 0$$

$x = -2$

$-5 < x < -2$

$x < -5$

Math Problem ID

TG9

Correct Answers and Answer Frequencies

Answer	Correct Answer(s)	Number Correct Answers	Number Incorrect Answers
$x = -2$	blinded	blinded	blinded
$-5 < x < -2$	blinded	blinded	blinded
$x < -5$	blinded	blinded	blinded

Note. Scoring (PCS4): All response options must be correctly chosen or correctly rejected to earn one points (up to 1 point possible).

Item Characteristics

Discrimination					
Measurement Type		Model A3	Model B	Model C	Model D
Correlation to participant ability (θ)		0.53	0.45	0.45	0.46
Discrimination Parameter (α)		1.11	1.03	0.91	1.11
Difficulty					
Measurement Type	Points	Model A3	Model B	Model C	Model D
Difficulty for participant of average ability level	1	0.52	0.62	0.60	0.57
	0	NA	NA	NA	NA
Cumulative probability for participant of average ability level	1	36.0%	34.6%	36.7%	34.6%
	0	100%	100%	100%	100%

Frequencies			
Groups	Points	Frequencies	Percent (%)
Complete sample for this math problem (n = 540)	1	205	38.0%
	0	335	62.0%
Female (n = 192)	1	68	35.4%
	0	124	64.6%
Male (n = 339)	1	134	39.5%
	0	205	60.5%
German as primary language at home (n = 402)	1	150	37.3%
	0	252	62.7%
Other language as primary language at home (n = 138)	1	55	39.9%
	0	83	60.1%
Secondary school completed in Germany (n = 482)	1	173	35.9%
	0	309	64.1%
Secondary school completed abroad (n = 57)	1	32	56.1%
	0	25	43.9%
Math not attended as advanced course in secondary school (n = 176)	1	44	25.0%
	0	132	75.0%
Math attended as advanced course in secondary school (n = 322)	1	140	43.5%
	0	182	56.5%
No math preparatory course attended (n = 235)	1	82	34.9%
	0	153	65.1%
Math preparatory course attended (n = 299)	1	120	40.1%
	0	179	59.9%
University of applied sciences (n = 132)	1	32	24.2%
	0	100	75.8%
University (n = 408)	1	173	42.4%
	0	235	57.6%
Online Participation (n = 377)	1	136	36.1%
	0	241	63.9%
Pen-and-Paper Participation (n = 163)	1	69	42.3%
	0	94	57.7%
Attended Gymnasium (n = 417)	1	168	40.3%
	0	249	59.7%
Attended Other Secondary School (n = 117)	1	33	28.2%
	0	84	71.8%

Note. Due to missing values on demographics questions, frequencies within groups may not add up to the total number of responses.

Plots

All plots are generated from **Model A3**.

Item Information

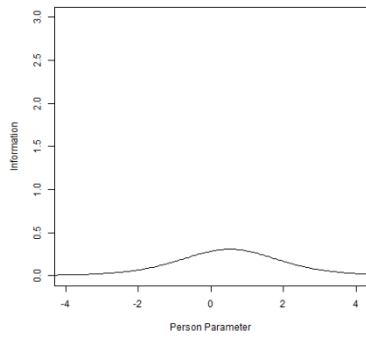

Expected Score

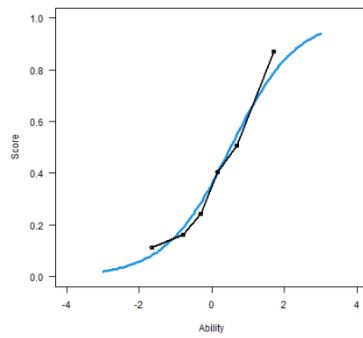

Probability

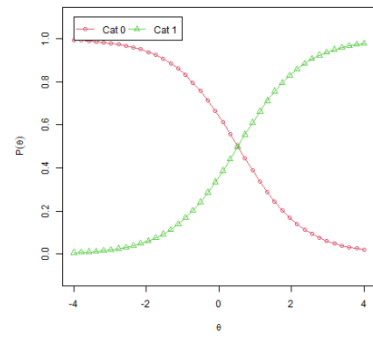

Note. The blue line represents expected performance, and the black line represents actual performance.

Note. Cat n = probability of receiving n points.

4.3.10. Matchstick Figure (TG10)

Streichholzfigur

Figur 1 Figur 2 Figur 3 Figur 4

Sei n die Nummer der Streichholzfigur. Geben Sie einen Term an, der die Anzahl der Streichhölzer in Abhängigkeit von n ausdrückt.

Ergänzen Sie das freie Feld.

Schreibweise:
 Nutzen Sie folgende Zeichen: + (Addition), - (Subtraktion), * (Multiplikation), / (Division), ^ (Potenz), () Klammern.

Term:

Math Problem ID

TG10

Correct Answers and Answer Frequencies

Correct Answer(s)	Number Correct Answers	Number Incorrect Answers
blinded	blinded	blinded

Note. Scoring (PCS4): Every correct response is worth one point (up to 1 point possible).

Item Characteristics

Discrimination					
Measurement Type		Model A3	Model B	Model C	Model D
Correlation to participant ability (θ)		0.68	0.64	0.64	0.65
Discrimination Parameter (α)		2.11	2.08	1.83	2.32
Difficulty					
Measurement Type	Points	Model A3	Model B	Model C	Model D
Difficulty for participant of average ability level	1	0.00	0.06	-0.04	0.05
	0	NA	NA	NA	NA
Cumulative probability for participant of average ability level	1	50.2%	47.1%	51.7%	47.1%
	0	100%	100%	100%	100%

Frequencies			
Groups	Points	Frequencies	Percent (%)
Complete sample for this math problem (n = 523)	1	273	52.2%
	0	250	47.8%
Female (n = 172)	1	72	41.9%
	0	100	58.1%
Male (n = 343)	1	197	57.4%
	0	146	42.6%
German as primary language at home (n = 397)	1	217	54.7%
	0	180	45.3%
Other language as primary language at home (n = 126)	1	56	44.4%
	0	70	55.6%
Secondary school completed in Germany (n = 472)	1	240	50.8%
	0	232	49.2%
Secondary school completed abroad (n = 49)	1	31	63.3%
	0	18	36.7%
Math not attended as advanced course in secondary school (n = 171)	1	44	25.7%
	0	127	74.3%
Math attended as advanced course in secondary school (n = 308)	1	200	64.9%
	0	108	35.1%
No math preparatory course attended (n = 232)	1	106	45.7%
	0	126	54.3%
Math preparatory course attended (n = 285)	1	164	57.5%
	0	121	42.5%
University of applied sciences (n = 120)	1	39	32.5%
	0	81	67.5%
University (n = 403)	1	234	58.1%
	0	169	41.9%
Online Participation (n = 357)	1	187	52.4%
	0	170	47.6%
Pen-and-Paper Participation (n = 166)	1	86	51.8%
	0	80	48.2%
Attended Gymnasium (n = 407)	1	230	56.5%
	0	177	43.5%
Attended Other Secondary School (n = 110)	1	39	35.5%
	0	71	64.5%

Note. Due to missing values on demographics questions, frequencies within groups may not add up to the total number of responses.

Plots

All plots are generated from **Model A3**.

Item Information

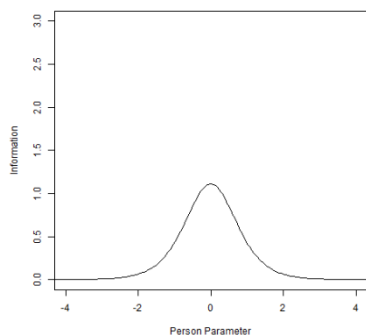

Expected Score

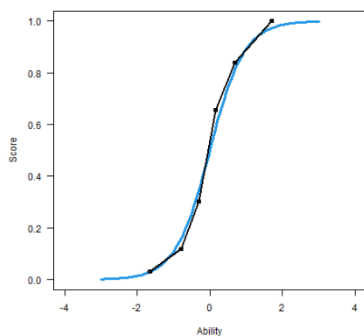

Note. The blue line represents expected performance, and the black line represents actual performance.

Probability

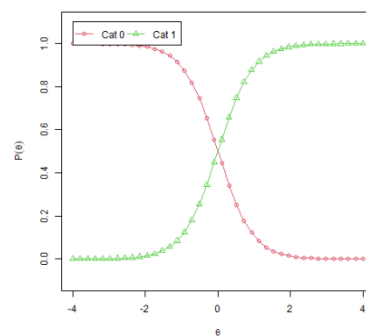

Note. Cat n = probability of receiving n points.

4.4. Elementary Functions (Elementare Funktionen; EF)

Q₃ Statistics for Elementary Functions

	EF1	EF2	EF3	EF4	EF5	EF6	EF7	EF8	EF9	EF10
EF1	-									
EF2	.070	-								
EF3	.042	.151	-							
EF4	-.093	.090	.074	-						
EF5	-.104	-.030	-.042	-.108	-					
EF6	.076	.261	.121	.171	.063	-				
EF7	-.201	-.233	-.094	-.108	-.232	-.177	-			
EF8	.017	-.183	-.164	-.180	-.153	-.172	-.047	-		
EF9	.012	.036	.078	.016	-.072	.144	-.097	-.098	-	
EF10	.013	.192	.132	-.040	-.002	.241	-.132	-.144	.047	-

Note. Q₃ statistics above the critical absolute value of 0.20 are bolded. For details see **Section 3.1**.

4.4.1. Function Values (EF1)

Funktionswerte

Gegeben sei die Funktion f mit der Funktionsvorschrift $f(x) = 3x + 2$.

Ergänzen Sie die freien Felder.

a)

$f(2) =$

b)

$f(f(2)) =$

c)

x	<input style="width: 50px; height: 20px;" type="text"/>
$f(x)$	-1

Math Problem ID

EF1

Correct Answers and Answer Frequencies

Math Problem Part	Correct Answer(s)	Number Correct Answers	Number Incorrect Answers
a)	blinded	blinded	blinded
b)	blinded	blinded	blinded
c)	blinded	blinded	blinded

Note. Scoring (PCS4): Every correct response is worth one point (up to 3 points possible).

Item Characteristics

Discrimination					
Measurement Type		Model A4	Model B	Model C	Model D
Correlation to participant ability (θ)		0.63	0.55	0.55	0.56
Discrimination Parameter (α)		1.34	1.15	1.04	1.26
Difficulty					
Measurement Type	Points	Model A4	Model B	Model C	Model D
Difficulty for participant of average ability level	3	-0.77	-0.89	-1.16	-0.84
	2	-1.55	-1.70	-2.20	-1.62
	1	-2.03	-2.19	-3.13	-2.10
	0	NA	NA	NA	NA
Cumulative probability for participant of average ability level	3	77.4%	78.0%	80.8%	78.2%
	2	97.8%	97.6%	98.2%	97.9%
	1	99.8%	99.7%	99.9%	99.7%
	0	100%	100%	100%	100%
Frequencies					
Groups	Points	Frequencies		Percent (%)	
Complete sample for this math problem (n = 530)	3	378		71.3%	
	2	104		19.6%	
	1	27		5.1%	
	0	21		4.0%	
Female (n = 166)	3	111		66.9%	
	2	40		24.1%	
	1	8		4.8%	
	0	7		4.2%	
Male (n = 359)	3	265		73.8%	
	2	62		17.3%	
	1	19		5.3%	
	0	13		3.6%	
German as primary language at home (n = 416)	3	296		71.2%	
	2	87		20.9%	
	1	22		5.3%	
	0	11		2.6%	
Other language as primary language at home (n = 112)	3	81		72.3%	
	2	17		15.2%	
	1	5		4.5%	
	0	9		8.0%	
Secondary school completed in Germany (n = 484)	3	341		70.5%	
	2	99		20.5%	
	1	26		5.4%	
	0	18		3.7%	

Frequencies			
Groups	Points	Frequencies	Percent (%)
Secondary school completed abroad (n = 45)	3	37	82.2%
	2	5	11.1%
	1	1	2.2%
	0	2	4.4%
Math not attended as advanced course in secondary school (n = 191)	3	101	52.9%
	2	58	30.4%
	1	20	10.5%
	0	12	6.3%
Math attended as advanced course in secondary school (n = 287)	3	236	82.2%
	2	40	13.9%
	1	6	2.1%
	0	5	1.7%
No math preparatory course attended (n = 239)	3	153	64.0%
	2	59	24.7%
	1	13	5.4%
	0	14	5.9%
Math preparatory course attended (n = 287)	3	222	77.4%
	2	45	15.7%
	1	14	4.9%
	0	6	2.1%
University of applied sciences (n = 135)	3	75	55.6%
	2	35	25.9%
	1	13	9.6%
	0	12	8.9%
University (n = 395)	3	303	76.7%
	2	69	17.5%
	1	14	3.5%
	0	9	2.3%
Online Participation (n = 359)	3	245	68.2%
	2	80	22.3%
	1	18	5.0%
	0	16	4.5%
Pen-and-Paper Participation (n = 171)	3	133	77.8%
	2	24	14.0%
	1	9	5.3%
	0	5	2.9%
Attended Gymnasium (n = 402)	3	298	74.1%
	2	81	20.1%
	1	19	4.7%
	0	4	1.0%
Attended Other Secondary School (n = 119)	3	75	63.0%
	2	22	18.5%
	1	8	6.7%
	0	14	11.8%

Note. Due to missing values on demographics questions, frequencies within groups may not add up to the total number of responses.

Plots

All plots are generated from **Model A4**.

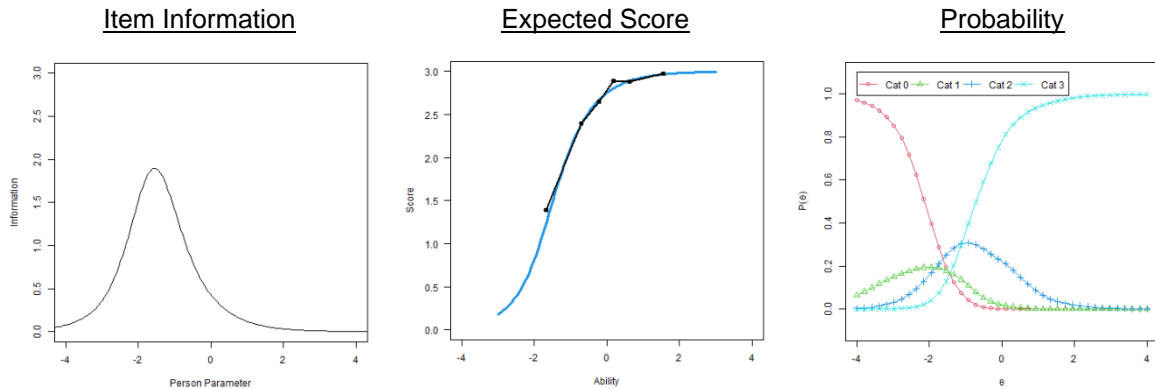

Note. The blue line represents expected performance, and the black line represents actual performance.

Note. Cat n = probability of receiving n points.

Differential Item Functioning (DIF)

This problem shows DIF across secondary school type. The discrimination (α) parameter was significantly lower for those who attended a Gymnasium. This shows that the problem was significantly less informative for those who attended a Gymnasium compared to another secondary school type.

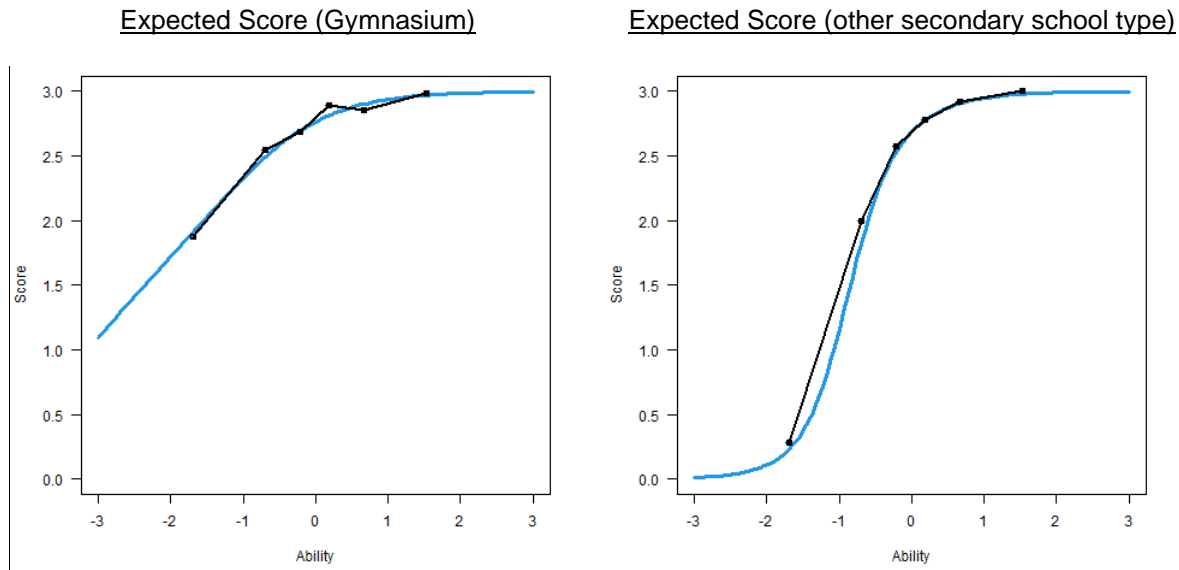

Note. The blue line represents expected performance, and the black line represents actual performance.

4.4.2. Domain and Value Sets (EF2)

Definitions- und Wertemengen

Ordnen Sie den folgenden Funktionstermen die korrekte Aussage über die maximale Definitionsmenge D und Wertemenge W zu.

Wählen Sie jeweils die richtige Antwort.

a)

$$f(x) = -5x^2:$$

$D = \mathbb{R}^{>0}$ und $W = \mathbb{R}$ A

$D = \mathbb{R} \setminus \{0\}$ und $W = \mathbb{R} \setminus \{0\}$ B

$D = \mathbb{R} \setminus \{0\}$ und $W = \mathbb{R}$ C

$D = \mathbb{R}$ und $W = \mathbb{R}$ D

$D = \mathbb{R}$ und $W = \mathbb{R}^{\leq 0}$ E

b)

$$f(x) = \frac{1}{x}:$$

$D = \mathbb{R}^{>0}$ und $W = \mathbb{R}$ A

$D = \mathbb{R} \setminus \{0\}$ und $W = \mathbb{R} \setminus \{0\}$ B

$D = \mathbb{R} \setminus \{0\}$ und $W = \mathbb{R}$ C

$D = \mathbb{R}$ und $W = \mathbb{R}$ D

$D = \mathbb{R}$ und $W = \mathbb{R}^{\leq 0}$ E

Math Problem ID

EF2

Correct Answers and Answer Frequencies

Math Problem Part	Correct Answer	Number Correct Answers	Number Incorrect Answers ^a	Answer Frequencies				
				A	B	C	D	E
a)	blinded	blinded	blinded	blinded	blinded	blinded	blinded	blinded
b)	blinded	blinded	blinded	blinded	blinded	blinded	blinded	blinded

Note. Scoring (PCS4): Every correct response is worth one point (up to 2 points possible).

^a Includes cases, where the problem was seen but not answered.

Item Characteristics

Discrimination					
Measurement Type		Model A4	Model B	Model C	Model D
Correlation to participant ability (θ)		0.75	0.72	0.71	0.72
Discrimination Parameter (α)		1.74	1.64	1.32	1.82
Difficulty					
Measurement Type	Points	Model A4	Model B	Model C	Model D
Difficulty for participant of average ability level	2	0.36	0.33	0.29	0.33
	1	-0.37	-0.44	-0.66	-0.41
	0	NA	NA	NA	NA
Cumulative probability for participant of average ability level	2	29.9%	32.4%	37.6%	31.0%
	1	70.4%	72.8%	77.0%	73.1%
	0	100%	100%	100%	100%
Frequencies					
Groups	Points	Frequencies		Percent (%)	
Complete sample for this math problem (n = 529)	2	209		39.5%	
	1	138		26.1%	
	0	182		34.4%	
Female (n = 165)	2	61		37.0%	
	1	38		23.0%	
	0	66		40.0%	
Male (n = 359)	2	148		41.2%	
	1	98		27.3%	
	0	113		31.5%	
German as primary language at home (n = 415)	2	165		39.8%	
	1	109		26.3%	
	0	141		34.0%	
Other language as primary language at home (n = 112)	2	43		38.4%	
	1	29		25.9%	
	0	40		35.7%	
Secondary school completed in Germany (n = 483)	2	186		38.5%	
	1	128		26.5%	
	0	169		35.0%	

Frequencies			
Groups	Points	Frequencies	Percent (%)
Secondary school completed abroad (n = 45)	2	23	51.1%
	1	10	22.2%
	0	12	26.7%
Math not attended as advanced course in secondary school (n = 191)	2	37	19.4%
	1	52	27.2%
	0	102	53.4%
Math attended as advanced course in secondary school (n = 286)	2	148	51.7%
	1	75	26.2%
	0	63	22.0%
No math preparatory course attended (n = 239)	2	79	33.1%
	1	57	23.8%
	0	103	43.1%
Math preparatory course attended (n = 286)	2	130	45.5%
	1	79	27.6%
	0	77	26.9%
University of applied sciences (n = 135)	2	22	16.3%
	1	38	28.1%
	0	75	55.6%
University (n = 394)	2	187	47.5%
	1	100	25.4%
	0	107	27.2%
Online Participation (n = 358)	2	141	39.4%
	1	90	25.1%
	0	127	35.5%
Pen-and-Paper Participation (n = 171)	2	68	39.8%
	1	48	28.1%
	0	55	32.2%
Attended Gymnasium (n = 401)	2	177	44.1%
	1	104	25.9%
	0	120	29.9%
Attended Other Secondary School (n = 119)	2	29	24.4%
	1	32	26.9%
	0	58	48.7%

Note. Due to missing values on demographics questions, frequencies within groups may not add up to the total number of responses.

Plots

All plots are generated from **Model A4**.

Item Information

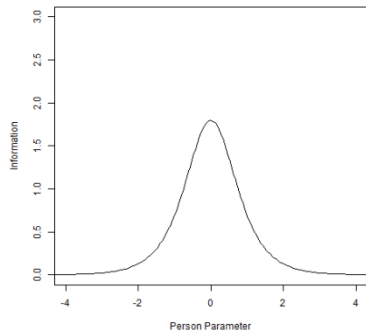

Expected Score

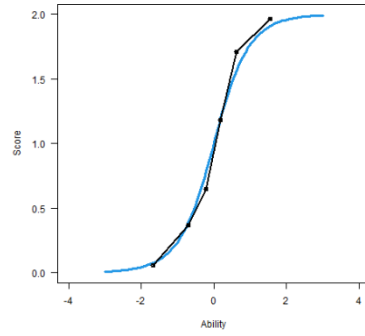

Probability

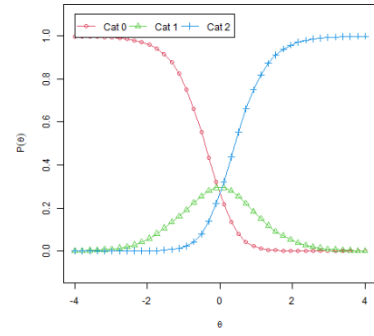

Note. The blue line represents expected performance, and the black line represents actual performance.

Note. Cat n = probability of receiving n points.

4.4.3. Point Symmetry (EF3)

Punktsymmetrie

Welche Eigenschaft muss bei einer Funktion f für alle x aus dem Definitionsbereich gelten, damit der Graph von f punktsymmetrisch zum Ursprung ist?

Ergänzen Sie das freie Feld.

$f(-x) =$

Math Problem ID

EF3

Correct Answers and Answer Frequencies

Correct Answer(s)	Number Correct Answers	Number Incorrect Answers
blinded	blinded	blinded

Note. Scoring (PCS4): Every correct response is worth one point (up to 1 point possible).

Item Characteristics

Discrimination					
Measurement Type		Model A4	Model B	Model C	Model D
Correlation to participant ability (θ)		0.61	0.58	0.58	0.58
Discrimination Parameter (α)		1.75	1.65	1.33	1.73
Difficulty					
Measurement Type	Points	Model A4	Model B	Model C	Model D
Difficulty for participant of average ability level	1	0.15	0.11	0.02	0.12
	0	NA	NA	NA	NA
Cumulative probability for participant of average ability level	1	43.3%	45.4%	49.5%	44.7%
	0	100%	100%	100%	100%
Frequencies					
Groups	Points	Frequencies		Percent (%)	
Complete sample for this math problem (n = 526)	1	252		47.9%	
	0	274		52.1%	
Female (n = 164)	1	75		45.7%	
	0	89		54.3%	
Male (n = 357)	1	176		49.3%	
	0	181		50.7%	
German as primary language at home (n = 412)	1	211		51.2%	
	0	201		48.8%	

Frequencies			
Groups	Points	Frequencies	Percent (%)
Other language as primary language at home (n = 112)	1	41	36.6%
	0	71	63.4%
Secondary school completed in Germany (n = 480)	1	239	49.8%
	0	241	50.2%
Secondary school completed abroad (n = 45)	1	13	28.9%
	0	32	71.1%
Math not attended as advanced course in secondary school (n = 190)	1	57	30.0%
	0	133	70.0%
Math attended as advanced course in secondary school (n = 285)	1	183	64.2%
	0	102	35.8%
No math preparatory course attended (n = 237)	1	94	39.7%
	0	143	60.3%
Math preparatory course attended (n = 285)	1	157	55.1%
	0	128	44.9%
University of applied sciences (n = 134)	1	44	32.8%
	0	90	67.2%
University (n = 392)	1	208	53.1%
	0	184	46.9%
Online Participation (n = 357)	1	173	48.5%
	0	184	51.5%
Pen-and-Paper Participation (n = 169)	1	79	46.7%
	0	90	53.3%
Attended Gymnasium (n = 398)	1	210	52.8%
	0	188	47.2%
Attended Other Secondary School (n = 119)	1	41	34.5%
	0	78	65.5%

Note. Due to missing values on demographics questions, frequencies within groups may not add up to the total number of responses.

Plots

All plots are generated from **Model A4**.

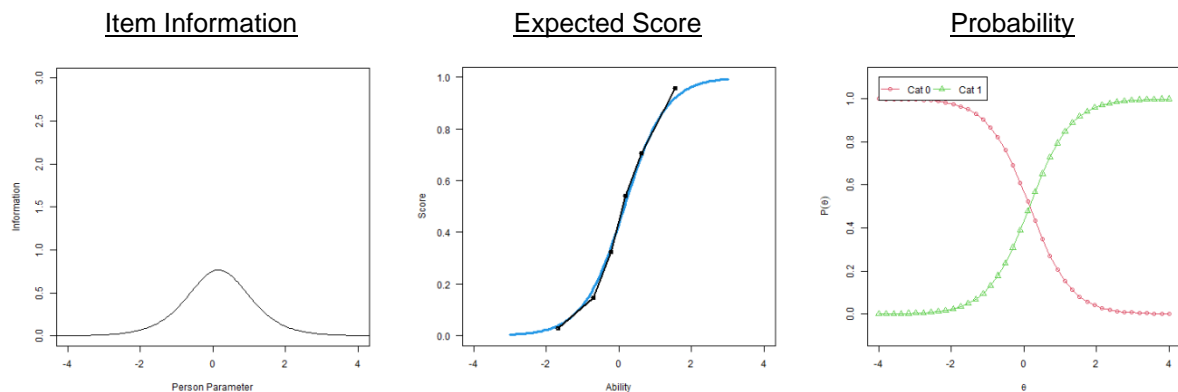

Note. The blue line represents expected performance, and the black line represents actual performance.

Note. Cat n = probability of receiving n points.

4.4.4. Lines (EF4)

Geraden

Gegeben sei die Gerade g mit $g(x) = 2 \cdot x - 4$.

Ergänzen Sie die freien Felder.

- Geben Sie die Steigung m_p jeder Geraden an, die zu g parallel liegt:

$m_p =$

- Geben Sie die Steigung m_s jeder Geraden an, die auf g senkrecht steht:

$m_s =$

- Geben Sie an, wo $g(x)$ die y -Achse schneidet:

$y =$

Math Problem ID

EF4

Changes to the Problem After the Main Study

This problem was changed after the main study. The reason for the implemented changes and results of qualitative interviews testing the revised version are reported in **Section 5**.

Correct Answers and Answer Frequencies

Blank	Correct Answer(s)	Number Correct Answers	Number Incorrect Answers
1	blinded	blinded	blinded
2	blinded	blinded	blinded
3	blinded	blinded	blinded

Note. Scoring (PCS4): Every correct response is worth one point (up to 3 points possible).

Item Characteristics

Discrimination					
Measurement Type		Model A4	Model B	Model C	Model D
Correlation to participant ability (θ)		0.76	0.70	0.68	0.70
Discrimination Parameter (α)		1.37	1.27	1.06	1.37
Difficulty					
Measurement Type	Points	Model A4	Model B	Model C	Model D
Difficulty for participant of average ability level	3	1.04	1.07	1.14	1.03
	2	-0.76	-0.82	-1.07	-0.78
	1	-1.45	-1.52	-1.94	-1.46
	0	NA	NA	NA	NA
Cumulative probability for participant of average ability level	3	16.6%	17.6%	20.2%	16.7%
	2	81.3%	81.7%	83.4%	82.0%
	1	96.6%	96.4%	97.2%	96.8%
	0	100%	100%	100%	100%
Frequencies					
Groups	Points	Frequencies		Percent (%)	
Complete sample for this math problem (n = 548)	3	129		23.5%	
	2	260		47.4%	
	1	87		15.9%	
	0	72		13.1%	
Female (n = 174)	3	37		21.3%	
	2	79		45.4%	
	1	28		16.1%	
	0	30		17.2%	
Male (n = 362)	3	90		24.9%	
	2	177		48.9%	
	1	58		16.0%	
	0	37		10.2%	
German as primary language at home (n = 416)	3	92		22.1%	
	2	216		51.9%	
	1	65		15.6%	
	0	43		10.3%	
Other language as primary language at home (n = 129)	3	37		28.7%	
	2	44		34.1%	
	1	22		17.1%	
	0	26		20.2%	
Secondary school completed in Germany (n = 495)	3	108		21.8%	
	2	245		49.5%	
	1	78		15.8%	
	0	64		12.9%	

Frequencies			
Groups	Points	Frequencies	Percent (%)
Secondary school completed abroad (n = 50)	3	21	42.0%
	2	15	30.0%
	1	9	18.0%
	0	5	10.0%
Math not attended as advanced course in secondary school (n = 198)	3	17	8.6%
	2	91	46.0%
	1	46	23.2%
	0	44	22.2%
Math attended as advanced course in secondary school (n = 285)	3	97	34.0%
	2	141	49.5%
	1	30	10.5%
	0	17	6.0%
No math preparatory course attended (n = 252)	3	52	20.6%
	2	117	46.4%
	1	42	16.7%
	0	41	16.3%
Math preparatory course attended (n = 286)	3	75	26.2%
	2	140	49.0%
	1	45	15.7%
	0	26	9.1%
University of applied sciences (n = 142)	3	20	14.1%
	2	61	43.0%
	1	30	21.1%
	0	31	21.8%
University (n = 406)	3	109	26.8%
	2	199	49.0%
	1	57	14.0%
	0	41	10.1%
Online Participation (n = 384)	3	97	25.3%
	2	173	45.1%
	1	63	16.4%
	0	51	13.3%
Pen-and-Paper Participation (n = 164)	3	32	19.5%
	2	87	53.0%
	1	24	14.6%
	0	21	12.8%
Attended Gymnasium (n = 399)	3	103	25.8%
	2	200	50.1%
	1	59	14.8%
	0	37	9.3%
Attended Other Secondary School (n = 137)	3	24	17.5%
	2	60	43.8%
	1	24	17.5%
	0	29	21.2%

Note. Due to missing values on demographics questions, frequencies within groups may not add up to the total number of responses.

Plots

All plots are generated from **Model A4**.

Item Information

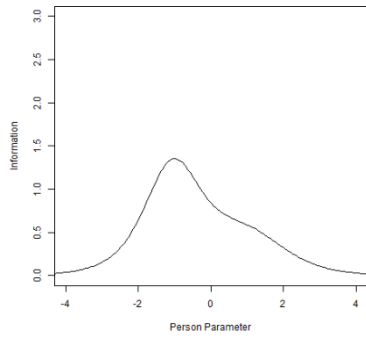

Expected Score

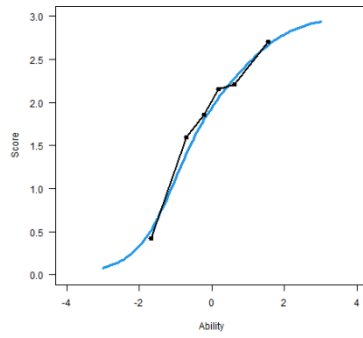

Note. The blue line represents expected performance, and the black line represents actual performance.

Probability

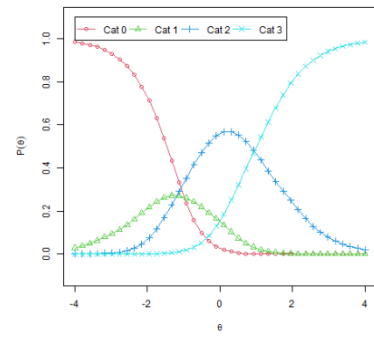

Note. Cat n = probability of receiving n points.

4.4.5. Parabels (EF5)

Parabeln

Bestimmen Sie den Scheitelpunkt und die Scheitelpunktform der folgenden Parabeln.

Ergänzen Sie die freien Felder.

a)
 $(x - 2)^2 + 3$:

Scheitelpunkt: (,)

b)
 $x^2 + 4x + 8$:

Scheitelpunktform: $(x + \text{})^2 + \text{}$

Math Problem ID

EF5

Correct Answers and Answer Frequencies

Math Problem Part	Blank	Correct Answer(s)	Number Correct Answers	Number Incorrect Answers
a)	1	blinded	blinded	blinded
	2	blinded	blinded	blinded
b)	1	blinded	blinded	blinded
	2	blinded	blinded	blinded

Note. Scoring (PCS4): For each part, both blanks must be correct to earn one point (up to 2 points possible).

Item Characteristics

Discrimination					
Measurement Type		Model A4	Model B	Model C	Model D
Correlation to participant ability (θ)		0.68	0.64	0.63	0.64
Discrimination Parameter (α)		1.30	1.18	0.94	1.28
Difficulty					
Measurement Type	Points	Model A4	Model B	Model C	Model D
Difficulty for participant of average ability level	2	0.30	0.27	0.21	0.27
	1	-0.48	-0.56	-0.82	-0.53
	0	NA	NA	NA	NA
Cumulative probability for participant of average ability level	2	36.5%	38.8%	43.0%	38.0%
	1	70.9%	72.5%	75.8%	72.5%
	0	100%	100%	100%	100%
Frequencies					
Groups	Points	Frequencies		Percent (%)	
Complete sample for this math problem (n = 519)	2	221		42.6%	
	1	130		25.0%	
	0	168		32.4%	
Female (n = 162)	2	68		42.0%	
	1	45		27.8%	
	0	49		30.2%	
Male (n = 352)	2	152		43.2%	
	1	85		24.1%	
	0	115		32.7%	
German as primary language at home (n = 407)	2	166		40.8%	
	1	101		24.8%	
	0	140		34.4%	
Other language as primary language at home (n = 110)	2	55		50.0%	
	1	29		26.4%	
	0	26		23.6%	
Secondary school completed in Germany (n = 474)	2	196		41.4%	
	1	122		25.7%	
	0	156		32.9%	
Secondary school completed abroad (n = 44)	2	25		56.8%	
	1	8		18.2%	
	0	11		25.0%	
Math not attended as advanced course in secondary school (n = 186)	2	49		26.3%	
	1	48		25.8%	
	0	89		47.8%	
Math attended as advanced course in secondary school (n = 282)	2	153		54.3%	
	1	66		23.4%	
	0	63		22.3%	

Frequencies			
Groups	Points	Frequencies	Percent (%)
No math preparatory course attended (n = 235)	2	83	35.3%
	1	63	26.8%
	0	89	37.9%
Math preparatory course attended (n = 280)	2	137	48.9%
	1	66	23.6%
	0	77	27.5%
University of applied sciences (n = 133)	2	32	24.1%
	1	40	30.1%
	0	61	45.9%
University (n = 386)	2	189	49.0%
	1	90	23.3%
	0	107	27.7%
Online Participation (n = 350)	2	156	44.6%
	1	88	25.1%
	0	106	30.3%
Pen-and-Paper Participation (n = 169)	2	65	38.5%
	1	42	24.9%
	0	62	36.7%
Attended Gymnasium (n = 392)	2	177	45.2%
	1	104	26.5%
	0	111	28.3%
Attended Other Secondary School (n = 118)	2	40	33.9%
	1	25	21.2%
	0	53	44.9%

Note. Due to missing values on demographics questions, frequencies within groups may not add up to the total number of responses.

Plots

All plots are generated from **Model A4**.

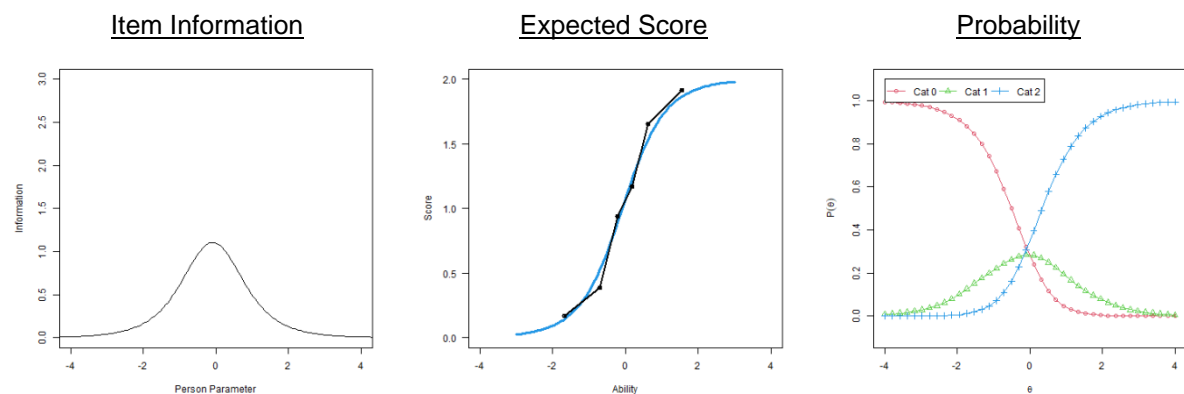

Note. The blue line represents expected performance, and the black line represents actual performance.

Note. Cat n = probability of receiving n points.

4.4.6. Intersection Points (EF6)

Schnittpunkte

Bei welchen x -Werten schneiden sich die durch $g(x) = 2 \cdot x + 4$ gegebene Gerade und die durch $p(x) = (x - 3)^2 + 2$ bestimmte Parabel?

Ergänzen Sie die x -Werte der Schnittpunkte.

Beachten Sie: Die Eingabereihenfolge der Werte hat keine Auswirkung auf die Auswertung der Aufgabe.

$P_1 : \quad x =$

$P_2 : \quad x =$

Math Problem ID

EF6

Correct Answers and Answer Frequencies

Blank	Correct Answer(s)	Number Correct Answers	Number Incorrect Answers
1	blinded	blinded	blinded
2	blinded	blinded	blinded

Note. Scoring (PCS4): Both blanks must be correct to earn one point (up to 1 point possible). The order in which the answers are given is irrelevant.

Item Characteristics

Discrimination					
Measurement Type		Model A4	Model B	Model C	Model D
Correlation to participant ability (θ)		0.66	0.62	0.61	0.62
Discrimination Parameter (α)		2.11	1.82	1.56	1.98
Difficulty					
Measurement Type	Points	Model A4	Model B	Model C	Model D
Difficulty for participant of average ability level	1	0.13	0.11	0.01	0.12
	0	NA	NA	NA	NA
Cumulative probability for participant of average ability level	1	43.4%	45.0%	49.5%	44.2%
	0	100%	100%	100%	100%

Frequencies			
Groups	Points	Frequencies	Percent (%)
Complete sample for this math problem (n = 539)	1	248	46.0%
	0	291	54.0%
Female (n = 170)	1	75	44.1%
	0	95	55.9%
Male (n = 357)	1	170	47.6%
	0	187	52.4%
German as primary language at home (n = 409)	1	183	44.7%
	0	226	55.3%
Other language as primary language at home (n = 127)	1	65	51.2%
	0	62	48.8%
Secondary school completed in Germany (n = 486)	1	213	43.8%
	0	273	56.2%
Secondary school completed abroad (n = 50)	1	35	70.0%
	0	15	30.0%
Math not attended as advanced course in secondary school (n = 193)	1	48	24.9%
	0	145	75.1%
Math attended as advanced course in secondary school (n = 281)	1	165	58.7%
	0	116	41.3%
No math preparatory course attended (n = 248)	1	110	44.4%
	0	138	55.6%
Math preparatory course attended (n = 282)	1	135	47.9%
	0	147	52.1%
University of applied sciences (n = 141)	1	35	24.8%
	0	106	75.2%
University (n = 398)	1	213	53.5%
	0	185	46.5%
Online Participation (n = 375)	1	181	48.3%
	0	194	51.7%
Pen-and-Paper Participation (n = 164)	1	67	40.9%
	0	97	59.1%
Attended Gymnasium (n = 391)	1	191	48.8%
	0	200	51.2%
Attended Other Secondary School (n = 136)	1	53	39.0%
	0	83	61.0%

Note. Due to missing values on demographics questions, frequencies within groups may not add up to the total number of responses.

Plots

All plots are generated from **Model A4**.

Item Information

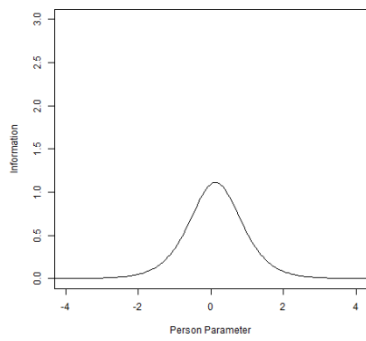

Expected Score

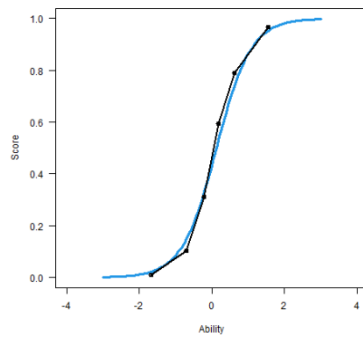

Note. The blue line represents expected performance, and the black line represents actual performance.

Probability

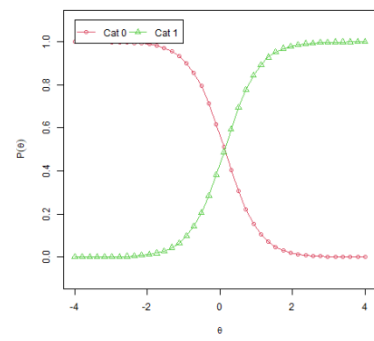

Note. Cat n = probability of receiving n points.

4.4.7. Slope Properties (EF7)

Steigungsverhalten

Bei welcher der folgenden Funktionen hat der Graph der Funktion auf dem ganzen Definitionsbereich eine Steigung entweder echt größer 0 oder echt kleiner 0?

Wählen Sie eine oder mehrere richtige Antworten.

$f(x) = 2 \cdot x$

$g(x) = x^4$

$u(x) = \sqrt{x}$

Math Problem ID

EF7

Correct Answers and Answer Frequencies

Answer	Correct Answer(s)	Number Correct Answers	Number Incorrect Answers
$f(x) = 2 \cdot x$	blinded	blinded	blinded
$g(x) = x^4$	blinded	blinded	blinded
$u(x) = \sqrt{x}$	blinded	blinded	blinded

Note. Scoring (PCS4): Every correct response and correct rejection is worth one point (up to 3 points possible).

Item Characteristics

Discrimination					
Measurement Type		Model A4	Model B	Model C	Model D
Correlation to participant ability (θ)		0.68	0.63	0.62	0.63
Discrimination Parameter (α)		0.93	0.92	0.82	0.95
Difficulty					
Measurement Type	Points	Model A4	Model B	Model C	Model D
Difficulty for participant of average ability level	3	0.46	0.44	0.39	0.44
	2	-0.69	-0.72	-0.95	-0.70
	1	-1.61	-1.65	-2.13	-1.61
	0	NA	NA	NA	NA
Cumulative probability for participant of average ability level	3	35.5%	36.2%	39.3%	35.7%
	2	75.1%	75.9%	78.8%	75.7%
	1	93.6%	93.8%	95.7%	93.8%
	0	100%	100%	100%	100%

Frequencies			
Groups	Points	Frequencies	Percent (%)
Complete sample for this math problem (n = 539)	3	201	37.3%
	2	165	30.6%
	1	98	18.2%
	0	75	13.9%
Female (n = 170)	3	45	26.5%
	2	57	33.5%
	1	33	19.4%
	0	35	20.6%
Male (n = 357)	3	152	42.6%
	2	107	30.0%
	1	62	17.4%
	0	36	10.1%
German as primary language at home (n = 409)	3	173	42.3%
	2	120	29.3%
	1	70	17.1%
	0	46	11.2%
Other language as primary language at home (n = 127)	3	28	22.0%
	2	44	34.6%
	1	27	21.3%
	0	28	22.0%
Secondary school completed in Germany (n = 486)	3	190	39.1%
	2	144	29.6%
	1	86	17.7%
	0	66	13.6%
Secondary school completed abroad (n = 50)	3	11	22.0%
	2	20	40.0%
	1	11	22.0%
	0	8	16.0%
Math not attended as advanced course in secondary school (n = 193)	3	39	20.2%
	2	65	33.7%
	1	44	22.8%
	0	45	23.3%
Math attended as advanced course in secondary school (n = 281)	3	149	53.0%
	2	77	27.4%
	1	37	13.2%
	0	18	6.4%
No math preparatory course attended (n = 248)	3	72	29.0%
	2	81	32.7%
	1	55	22.2%
	0	40	16.1%
Math preparatory course attended (n = 282)	3	128	45.4%
	2	81	28.7%
	1	41	14.5%
	0	32	11.3%

Frequencies			
Groups	Points	Frequencies	Percent (%)
University of applied sciences (n = 141)	3	24	17.0%
	2	54	38.3%
	1	34	24.1%
	0	29	20.6%
University (n = 398)	3	177	44.5%
	2	111	27.9%
	1	64	16.1%
	0	46	11.6%
Online Participation (n = 375)	3	138	36.8%
	2	119	31.7%
	1	74	19.7%
	0	44	11.7%
Pen-and-Paper Participation (n = 164)	3	63	38.4%
	2	46	28.0%
	1	24	14.6%
	0	31	18.9%
Attended Gymnasium (n = 391)	3	168	43.0%
	2	113	28.9%
	1	62	15.9%
	0	48	12.3%
Attended Other Secondary School (n = 136)	3	32	23.5%
	2	48	35.3%
	1	32	23.5%
	0	24	17.6%

Note. Due to missing values on demographics questions, frequencies within groups may not add up to the total number of responses.

Plots

All plots are generated from **Model A4**.

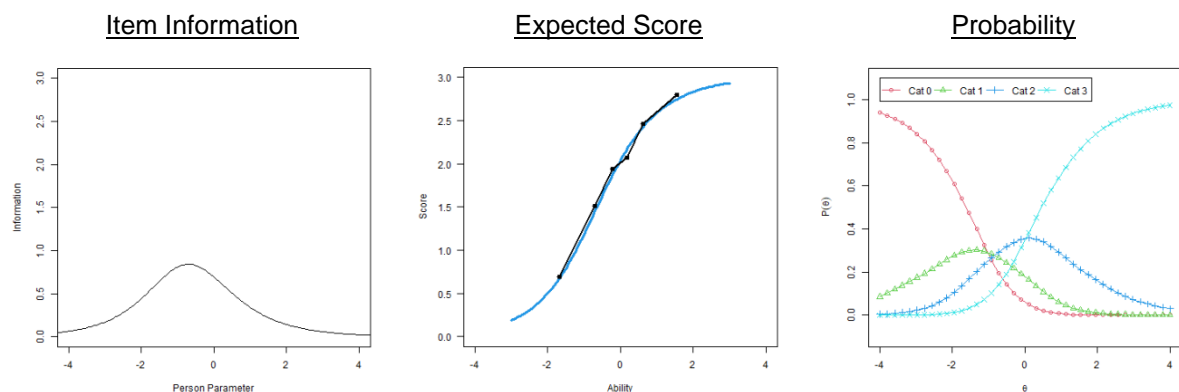

Note. The blue line represents expected performance, and the black line represents actual performance.

Note. Cat n = probability of receiving n points.

Differential Item Functioning (DIF)

This problem shows DIF across primary language. The difficulty (β) parameter was significantly higher for those who spoke a different language than German as their primary language at home. Meanwhile, the discrimination (α) parameter was significantly lower for those who spoke a different language than German at home. This shows that the problem was significantly easier and more informative for those who spoke German at home.

Expected Score (German as primary language)

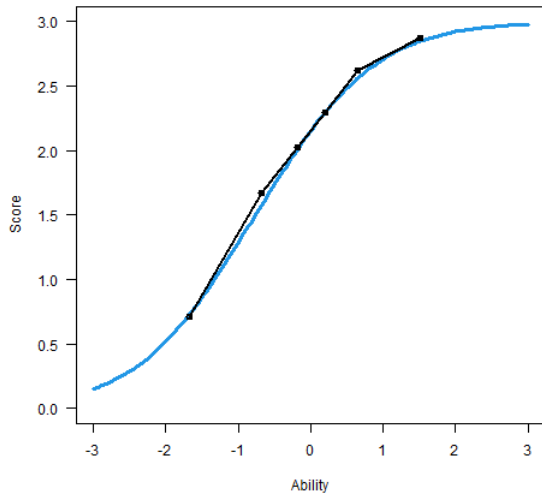

Expected Score (other primary language)

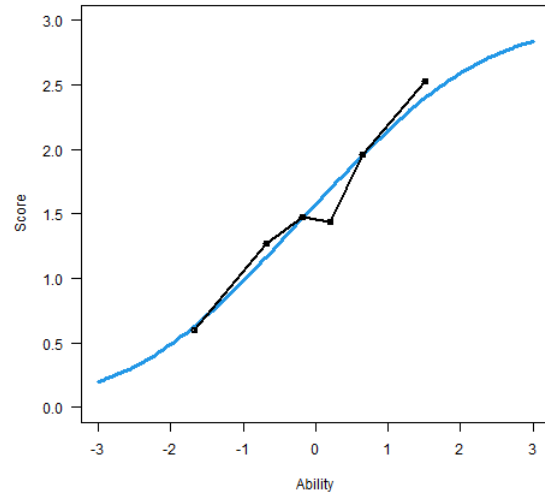

Note. The blue line represents expected performance, and the black line represents actual performance.

4.4.8. Value Tables for Graphs of a Function (EF8)

Wertetabellen zu Funktionsgraphen

Welche Wertetabellen könnten jeweils unter Wahl einer bestimmten linearen Achsenskalierung einen Ausschnitt der abgebildeten Funktionen darstellen?

Wählen Sie jeweils die richtige Antwort.

Hinweis: Die Koordinaten-Achsen schneiden sich bei $(0|0)$.

a)

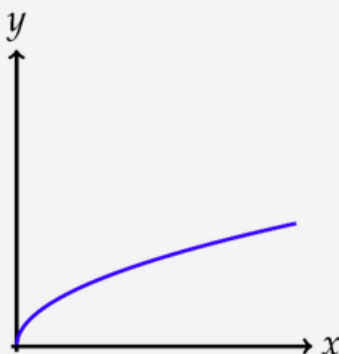

x	2	4	6
y	2	8	18

A

x	0,5	1	3
y	12	6	2

B

x	1	4	9
y	0,1	0,2	0,3

C

x	1	4	8
y	8	5	1

D

b)

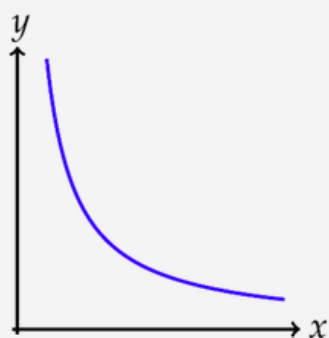

x	2	4	6
y	2	8	18

A

x	0,5	1	3
y	12	6	2

B

x	1	4	9
y	0,1	0,2	0,3

C

x	1	4	8
y	8	5	1

D

Math Problem ID

EF8

Correct Answers and Answer Frequencies

Math Problem Part	Correct Answer	Number Correct Answers	Number Incorrect Answers ^a	Answer Frequencies			
				A	B	C	D
a)	blinded	blinded	blinded	blinded	blinded	blinded	blinded
b)	blinded	blinded	blinded	blinded	blinded	blinded	blinded

Note. Scoring (PCS4): Every correct response is worth one point (up to 2 points possible).

^a Includes cases, where the problem was seen but not answered.

Item Characteristics

Discrimination					
Measurement Type		Model A4	Model B	Model C	Model D
Correlation to participant ability (θ)		0.45	0.42	0.41	0.43
Discrimination Parameter (α)		0.59	0.59	0.50	0.61
Difficulty					
Measurement Type	Points	Model A4	Model B	Model C	Model D
Difficulty for participant of average ability level	2	0.52	0.50	0.48	0.50
	1	-1.74	-1.75	-2.17	-1.70
	0	NA	NA	NA	NA
Cumulative probability for participant of average ability level	2	40.2%	40.5%	42.4%	40.3%
	1	80.3%	80.7%	81.9%	80.6%
	0	100%	100%	100%	100%
Frequencies					
Groups	Points	Frequencies		Percent (%)	
Complete sample for this math problem (n = 528)	2	217		40.6%	
	1	198		37.0%	
	0	120		22.4%	
Female (n = 169)	2	64		37.9%	
	1	65		38.5%	
	0	40		23.7%	
Male (n = 354)	2	147		41.5%	
	1	130		36.7%	
	0	77		21.8%	
German as primary language at home (n = 408)	2	177		43.4%	
	1	151		37.0%	
	0	80		19.6%	
Other language as primary language at home (n = 124)	2	39		31.5%	
	1	46		37.1%	
	0	39		31.5%	
Secondary school completed in Germany (n = 483)	2	197		40.8%	
	1	183		37.9%	
	0	103		21.3%	
Secondary school completed abroad (n = 49)	2	19		38.8%	
	1	14		28.6%	
	0	16		32.7%	
Math not attended as advanced course in secondary school (n = 192)	2	52		27.1%	
	1	79		41.1%	
	0	61		31.8%	
Math attended as advanced course in secondary school (n = 279)	2	145		52.0%	
	1	93		33.3%	
	0	41		14.7%	

Frequencies			
Groups	Points	Frequencies	Percent (%)
No math preparatory course attended (n = 245)	2	86	35.1%
	1	91	37.1%
	0	68	27.8%
Math preparatory course attended (n = 281)	2	127	45.2%
	1	105	37.4%
	0	49	17.4%
University of applied sciences (n = 139)	2	40	28.8%
	1	53	38.1%
	0	46	33.1%
University (n = 396)	2	177	44.7%
	1	145	36.6%
	0	74	18.7%
Online Participation (n = 373)	2	157	42.1%
	1	138	37.0%
	0	78	20.9%
Pen-and-Paper Participation (n = 162)	2	60	37.0%
	1	60	37.0%
	0	42	25.9%
Attended Gymnasium (n = 388)	2	170	43.8%
	1	142	36.6%
	0	76	19.6%
Attended Other Secondary School (n = 135)	2	42	31.1%
	1	52	38.5%
	0	41	30.4%

Note. Due to missing values on demographics questions, frequencies within groups may not add up to the total number of responses.

Plots

All plots are generated from **Model A4**.

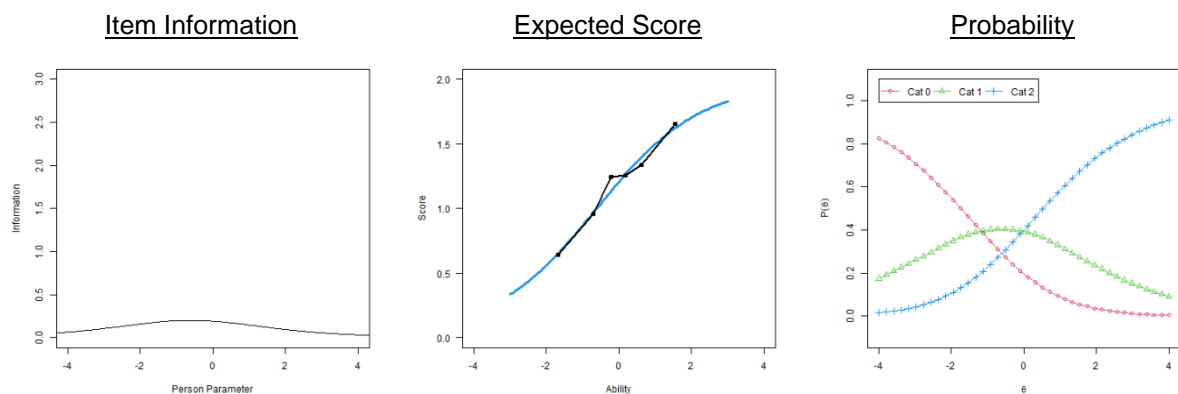

Note. The blue line represents expected performance, and the black line represents actual performance.

Note. Cat n = probability of receiving n points.

4.4.9. Argument and Function Values (EF9)

Argument und Funktionswert

Die Abbildung zeigt den Graphen einer Funktion f . Wählen Sie den korrekten Ausdruck für die auf der x-Achse markierte Stelle A .

Wählen Sie die richtige Antwort.

A $f(5)$

B $-f(5)$

C $f^{-1}(5)$

Math Problem ID

EF9

Correct Answers and Answer Frequencies

Correct Answer	Number Correct Answers	Number Incorrect Answers ^a	Answer Frequencies		
			A	B	C
blinded	blinded	blinded	blinded	blinded	blinded

Note. Scoring (PCS4): Every correct response is worth one point (up to 1 point possible).

^a Includes cases, where the problem was seen but not answered.

Item Characteristics

Discrimination					
Measurement Type	Points	Model A4	Model B	Model C	Model D
Correlation to participant ability (θ)		0.57	0.52	0.52	0.53
Discrimination Parameter (α)		1.57	1.40	1.15	1.52
Difficulty					
Measurement Type	Points	Model A4	Model B	Model C	Model D
Difficulty for participant of average ability level	1	-0.43	-0.52	-0.76	-0.48
	0	NA	NA	NA	NA
Cumulative probability for participant of average ability level	1	66.3%	67.5%	70.5%	67.4%
	0	100%	100%	100%	100%

Frequencies			
Groups	Points	Frequencies	Percent (%)
Complete sample for this math problem (n = 524)	1	335	63.9%
	0	189	36.1%
Female (n = 164)	1	97	59.1%
	0	67	40.9%
Male (n = 355)	1	235	66.2%
	0	120	33.8%
German as primary language at home (n = 411)	1	263	64.0%
	0	148	36.0%
Other language as primary language at home (n = 111)	1	72	64.9%
	0	39	35.1%
Secondary school completed in Germany (n = 478)	1	305	63.8%
	0	173	36.2%
Secondary school completed abroad (n = 45)	1	30	66.7%
	0	15	33.3%
Math not attended as advanced course in secondary school (n = 189)	1	83	43.9%
	0	106	56.1%
Math attended as advanced course in secondary school (n = 284)	1	221	77.8%
	0	63	22.2%
No math preparatory course attended (n = 237)	1	138	58.2%
	0	99	41.8%
Math preparatory course attended (n = 283)	1	194	68.6%
	0	89	31.4%
University of applied sciences (n = 134)	1	53	39.6%
	0	81	60.4%
University (n = 390)	1	282	72.3%
	0	108	27.7%
Online Participation (n = 355)	1	235	66.2%
	0	120	33.8%
Pen-and-Paper Participation (n = 169)	1	100	59.2%
	0	69	40.8%
Attended Gymnasium (n = 397)	1	263	66.2%
	0	134	33.8%
Attended Other Secondary School (n = 118)	1	70	59.3%
	0	48	40.7%

Note. Due to missing values on demographics questions, frequencies within groups may not add up to the total number of responses.

Plots

All plots are generated from **Model A4**.

Item Information

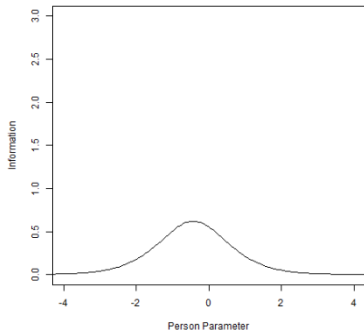

Expected Score

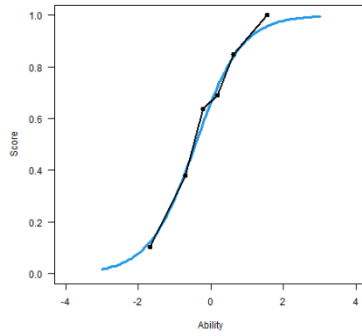

Probability

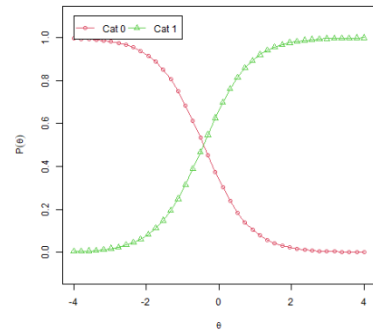

Note. The blue line represents expected performance, and the black line represents actual performance.

Note. Cat n = probability of receiving n points.

4.4.10. Simple and Double Null States (EF10)

Einfache und doppelte Nullstellen

Betrachten Sie die Funktion $f(x) = (x + 2) \cdot (x + 1)^2$. Welche der folgenden Aussagen über die Existenz von einfachen und doppelten Nullstellen von f ist richtig?

Wählen Sie die richtige Antwort.

Einfache Nullstelle bei $x = 1$, doppelte Nullstelle bei $x = 2$. A

Einfache Nullstelle bei $x = -1$, doppelte Nullstelle bei $x = -2$. B

Einfache Nullstelle bei $x = 2$, doppelte Nullstelle bei $x = 1$. C

Einfache Nullstelle bei $x = -2$, doppelte Nullstelle bei $x = -1$. D

Math Problem ID

EF10

Correct Answers and Answer Frequencies

Correct Answer	Number Correct Answers	Number Incorrect Answers ^a	Answer Frequencies			
			A	B	C	D
blinded	blinded	blinded	blinded	blinded	blinded	blinded

Note. Scoring (PCS4): Every correct response is worth one point (up to 1 point possible).

^a Includes cases, where the problem was seen but not answered.

Item Characteristics

Discrimination					
Measurement Type		Model A4	Model B	Model C	Model D
Correlation to participant ability (θ)		0.61	0.55	0.54	0.55
Discrimination Parameter (α)		1.72	1.49	1.28	1.63
Difficulty					
Measurement Type	Points	Model A4	Model B	Model C	Model D
Difficulty for participant of average ability level	1	-0.52	-0.58	-0.79	-0.54
	0	NA	NA	NA	NA
Cumulative probability for participant of average ability level	1	70.9%	70.3%	73.2%	70.7%
	0	100%	100%	100%	100%

Frequencies			
Groups	Points	Frequencies	Percent (%)
Complete sample for this math problem (n = 517)	1	335	64.5%
	0	184	35.5%
Female (n = 166)	1	107	64.5%
	0	59	35.5%
Male (n = 342)	1	222	64.9%
	0	120	35.1%
German as primary language at home (n = 396)	1	258	65.2%
	0	138	34.8%
Other language as primary language at home (n = 121)	1	76	62.8%
	0	45	37.2%
Secondary school completed in Germany (n = 469)	1	298	63.5%
	0	171	36.5%
Secondary school completed abroad (n = 48)	1	36	75.0%
	0	12	25.0%
Math not attended as advanced course in secondary school (n = 186)	1	80	43.0%
	0	106	57.0%
Math attended as advanced course in secondary school (n = 273)	1	212	77.7%
	0	61	22.3%
No math preparatory course attended (n = 242)	1	153	63.2%
	0	89	36.8%
Math preparatory course attended (n = 269)	1	178	66.2%
	0	91	33.8%
University of applied sciences (n = 123)	1	60	48.8%
	0	63	51.2%
University (n = 396)	1	275	69.4%
	0	121	30.6%
Online Participation (n = 357)	1	236	66.1%
	0	121	33.9%
Pen-and-Paper Participation (n = 162)	1	99	61.1%
	0	63	38.9%
Attended Gymnasium (n = 381)	1	260	68.2%
	0	121	31.8%
Attended Other Secondary School (n = 127)	1	69	54.3%
	0	58	45.7%

Note. Due to missing values on demographics questions, frequencies within groups may not add up to the total number of responses.

Plots

All plots are generated from **Model A4**.

Item Information

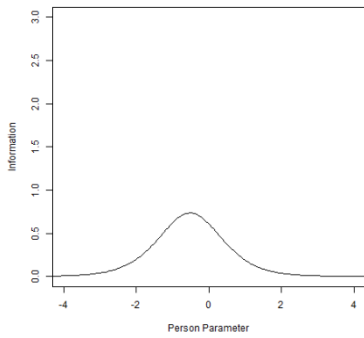

Expected Score

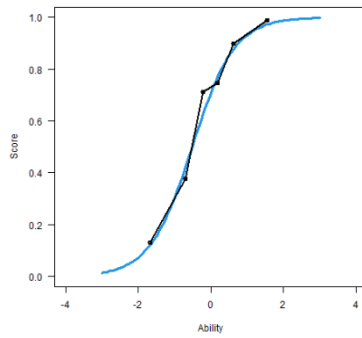

Probability

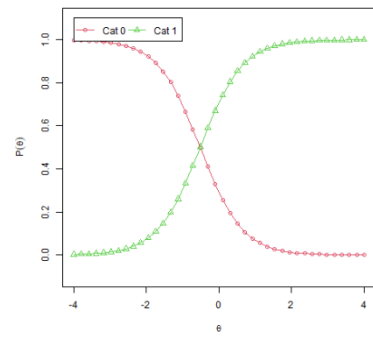

Note. The blue line represents expected performance, and the black line represents actual performance.

Note. Cat n = probability of receiving n points.

4.5. Elementary Geometry (Elementare Geometrie; G)

Q₃ Statistics for Elementary Geometry

	G1	G2	G3	G4	G5	G6	G7	G8	G9	G10
G1	-									
G2	-.022	-								
G3	-.386	-.341	-							
G4	.032	-.110	-.284	-						
G5	-.186	-.135	-.136	-.068	-					
G6	-.145	-.045	-.199	-.136	-.101	-				
G7	-.151	-.068	.058	-.190	-.013	-.156	-			
G8	.043	-.057	-.249	-.027	-.222	-.020	-.221	-		
G9	-.005	-.016	-.235	-.101	-.119	-.137	-.109	.063	-	
G10	-.212	-.197	-.156	-.124	-.069	-.120	-.031	.068	.009	-

Note. Q₃ statistics above the critical absolute value of 0.20 are bolded. For details see **Section 3.1**.

4.5.1. Measurement Units (G1)

Maßeinheiten

Tragen Sie die richtigen Umrechnungsfaktoren zwischen den Maßeinheiten ein.

Beispiel: $m \xrightarrow{\cdot 100} cm$

Ergänzen Sie die freien Felder.

$km \xrightarrow{\cdot} m$
 $m^2 \xrightarrow{\cdot} cm^2$
 $cm^3 \xrightarrow{\cdot} mm^3$

Math Problem ID

G1

Correct Answers and Answer Frequencies

Blank	Correct Answer(s)	Number Correct Answers	Number Incorrect Answers
1	blinded	blinded	blinded
2	blinded	blinded	blinded
3	blinded	blinded	blinded

Note. Scoring (PCS4): Every correct response is worth one point (up to 3 points possible).

Item Characteristics

Discrimination					
Measurement Type		Model A5	Model B	Model C	Model D
Correlation to participant ability (θ)		0.56	0.49	0.54	0.52
Discrimination Parameter (α)		0.62	0.57	0.96	0.65
Difficulty					
Measurement Type	Points	Model A5	Model B	Model C	Model D
Difficulty for participant of average ability level	3	0.25	0.24	0.06	0.22
	2	-0.96	-1.05	-0.93	-0.96
	1	-2.22	-2.41	-2.05	-2.20
	0	NA	NA	NA	NA
Cumulative probability for participant of average ability level	3	44.2%	44.8%	48.0%	44.5%
	2	75.2%	75.6%	82.2%	76.0%
	1	92.9%	93.0%	97.1%	93.4%
	0	100%	100%	100%	100%
Frequencies					
Groups	Points	Frequencies	Percent (%)		
Complete sample for this math problem (n = 555)	3	248	44.7%		
	2	150	27.0%		
	1	98	17.7%		
	0	59	10.6%		
Female (n = 169)	3	59	34.9%		
	2	40	23.7%		
	1	45	26.6%		
	0	25	14.8%		
Male (n = 379)	3	188	49.6%		
	2	107	28.2%		
	1	51	13.5%		
	0	33	8.7%		
German as primary language at home (n = 420)	3	188	44.8%		
	2	115	27.4%		
	1	76	18.1%		
	0	41	9.8%		
Other language as primary language at home (n = 133)	3	60	45.1%		
	2	34	25.6%		
	1	22	16.5%		
	0	17	12.8%		
Secondary school completed in Germany (n = 499)	3	216	43.3%		
	2	138	27.7%		
	1	91	18.2%		
	0	54	10.8%		

Frequencies			
Groups	Points	Frequencies	Percent (%)
Secondary school completed abroad (n = 55)	3	32	58.2%
	2	11	20.0%
	1	7	12.7%
	0	5	9.1%
Math not attended as advanced course in secondary school (n = 192)	3	57	29.7%
	2	51	26.6%
	1	57	29.7%
	0	27	14.1%
Math attended as advanced course in secondary school (n = 323)	3	169	52.3%
	2	91	28.2%
	1	36	11.1%
	0	27	8.4%
No math preparatory course attended (n = 267)	3	109	40.8%
	2	68	25.5%
	1	55	20.6%
	0	35	13.1%
Math preparatory course attended (n = 283)	3	137	48.4%
	2	81	28.6%
	1	42	14.8%
	0	23	8.1%
University of applied sciences (n = 145)	3	52	35.9%
	2	36	24.8%
	1	38	26.2%
	0	19	13.1%
University (n = 410)	3	196	47.8%
	2	114	27.8%
	1	60	14.6%
	0	40	9.8%
Online Participation (n = 402)	3	183	45.5%
	2	111	27.6%
	1	63	15.7%
	0	45	11.2%
Pen-and-Paper Participation (n = 153)	3	65	42.5%
	2	39	25.5%
	1	35	22.9%
	0	14	9.2%
Attended Gymnasium (n = 407)	3	187	45.9%
	2	112	27.5%
	1	68	16.7%
	0	40	9.8%
Attended Other Secondary School (n = 142)	3	60	42.3%
	2	37	26.1%
	1	28	19.7%
	0	17	12.0%

Note. Due to missing values on demographics questions, frequencies within groups may not add up to the total number of responses.

Plots

All plots are generated from **Model A5**.

Item Information

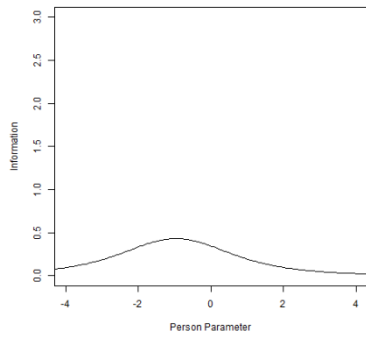

Expected Score

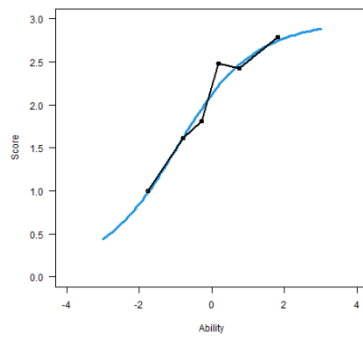

Note. The blue line represents expected performance, and the black line represents actual performance.

Probability

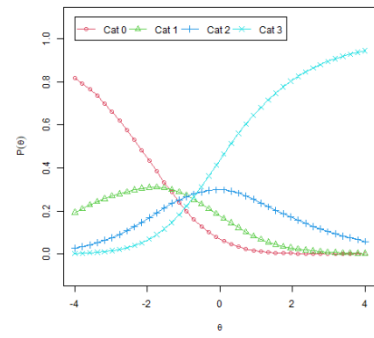

Note. Cat n = probability of receiving n points.

4.5.2. Determining Angle Sizes (G2)

Winkel bestimmen

In der folgenden Abbildung verlaufen zwei Geraden parallel, alle anderen schneiden sich jeweils.

Bestimmen Sie die eingezeichneten Winkel und ergänzen Sie die freien Felder.

$\alpha =$ °

$\beta =$ °

$\gamma =$ °

$\delta =$ °

Math Problem ID

G2

Correct Answers and Answer Frequencies

Blank	Correct Answer(s)	Number Correct Answers	Number Incorrect Answers
1	blinded	blinded	blinded
2	blinded	blinded	blinded
3	blinded	blinded	blinded
4	blinded	blinded	blinded

Note. Scoring (PCS4): Every correct response is worth one point (up to 4 points possible).

Item Characteristics

Discrimination					
Measurement Type		Model A5	Model B	Model C	Model D
Correlation to participant ability (θ)		0.58	0.50	0.56	0.52
Discrimination Parameter (α)		0.64	0.57	1.36	0.68
Difficulty					
Measurement Type	Points	Model A5	Model B	Model C	Model D
Difficulty for participant of average ability level	4	-0.86	-0.89	-0.78	-0.84
	3	-1.32	-1.37	-1.16	-1.29
	2	-1.81	-1.88	-1.57	-1.76
	1	-2.53	-2.63	-2.22	-2.45
	0	NA	NA	NA	NA
Cumulative probability for participant of average ability level	4	73.5%	72.5%	82.1%	73.9%
	3	88.3%	87.2%	96.1%	88.9%
	2	96.1%	95.3%	99.5%	96.5%
	1	98.9%	98.5%	100%	99.0%
	0	100%	100%	100%	100%
Frequencies					
Groups	Points	Frequencies	Percent (%)		
Complete sample for this math problem (n = 575)	4	387	67.3%		
	3	76	13.2%		
	2	52	9.0%		
	1	32	5.6%		
	0	28	4.9%		
Female (n = 173)	4	100	57.8%		
	3	27	15.6%		
	2	21	12.1%		
	1	11	6.4%		
	0	14	8.1%		
Male (n = 394)	4	285	72.3%		
	3	45	11.4%		
	2	31	7.9%		
	1	21	5.3%		
	0	12	3.0%		
German as primary language at home (n = 439)	4	306	69.7%		
	3	58	13.2%		
	2	36	8.2%		
	1	22	5.0%		
	0	17	3.9%		

Frequencies			
Groups	Points	Frequencies	Percent (%)
Other language as primary language at home (n = 134)	4	81	60.4%
	3	17	12.7%
	2	16	11.9%
	1	10	7.5%
	0	10	7.5%
Secondary school completed in Germany (n = 525)	4	354	67.4%
	3	69	13.1%
	2	45	8.6%
	1	30	5.7%
	0	27	5.1%
Secondary school completed abroad (n = 49)	4	33	67.3%
	3	7	14.3%
	2	7	14.3%
	1	2	4.1%
	0	0	0.0%
Math not attended as advanced course in secondary school (n = 214)	4	118	55.1%
	3	29	13.6%
	2	26	12.1%
	1	20	9.3%
	0	21	9.8%
Math attended as advanced course in secondary school (n = 315)	4	237	75.2%
	3	43	13.7%
	2	20	6.3%
	1	10	3.2%
	0	5	1.6%
No math preparatory course attended (n = 281)	4	173	61.6%
	3	37	13.2%
	2	29	10.3%
	1	24	8.5%
	0	18	6.4%
Math preparatory course attended (n = 288)	4	209	72.6%
	3	39	13.5%
	2	23	8.0%
	1	8	2.8%
	0	9	3.1%
University of applied sciences (n = 150)	4	76	50.7%
	3	24	16.0%
	2	15	10.0%
	1	20	13.3%
	0	15	10.0%
University (n = 425)	4	311	73.2%
	3	52	12.2%
	2	37	8.7%
	1	12	2.8%
	0	13	3.1%

Frequencies			
Groups	Points	Frequencies	Percent (%)
Online Participation (n = 412)	4	270	65.5%
	3	54	13.1%
	2	41	10.0%
	1	24	5.8%
	0	23	5.6%
Pen-and-Paper Participation (n = 163)	4	117	71.8%
	3	22	13.5%
	2	11	6.7%
	1	8	4.9%
	0	5	3.1%
Attended Gymnasium (n = 429)	4	309	72.0%
	3	58	13.5%
	2	34	7.9%
	1	15	3.5%
	0	13	3.0%
Attended Other Secondary School (n = 141)	4	74	52.5%
	3	18	12.8%
	2	18	12.8%
	1	17	12.1%
	0	14	9.9%

Note. Due to missing values on demographics questions, frequencies within groups may not add up to the total number of responses.

Plots

All plots are generated from **Model A5**.

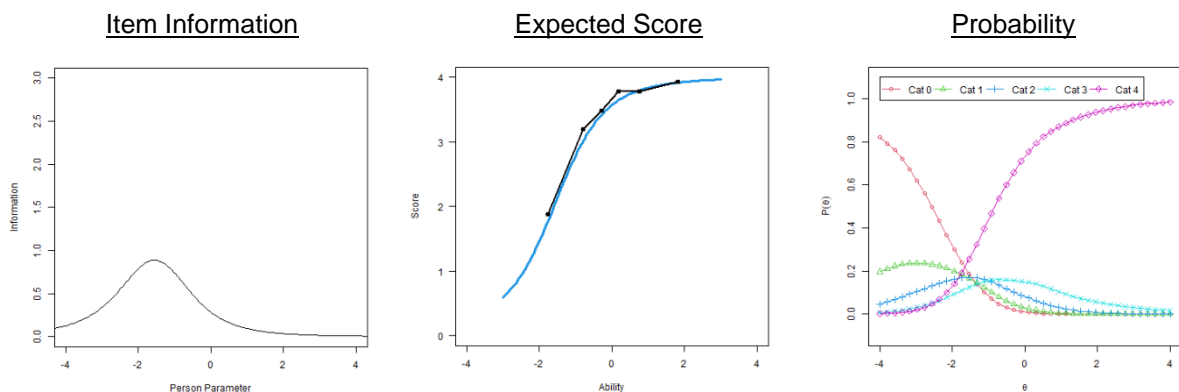

Note. The blue line represents expected performance, and the black line represents actual performance.

Note. Cat n = probability of receiving n points.

4.5.3. Areas (G3)

Flächeninhalte

Berechnen Sie die Flächeninhalte der folgenden Figuren. Geben Sie bei der ersten Figur zusätzlich die Länge der Strecke h an.

Ergänzen Sie die freien Felder.

Beachten Sie: π wird als pi eingegeben.

Schreibweise:

Nutzen Sie folgende Zeichen: + (Addition), - (Subtraktion), * (Multiplikation), / (Division), ^ (Potenz).

a)

Ein gleichschenkliges Dreieck mit Kantenlängen 8cm, 5cm, 5cm:

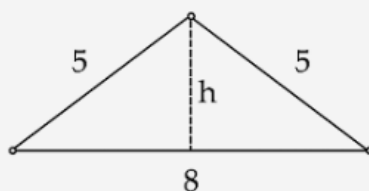

Höhe des Dreiecks: $h =$ cm

Flächeninhalt des Dreiecks: cm^2

b)

Ein Kreissektor mit Radius 9cm und Winkel 240° :

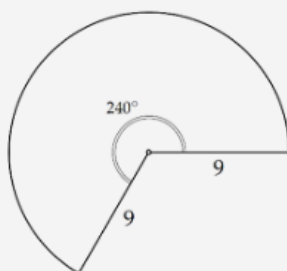

Hinweis: Flächeninhalt Kreis: $A_{\text{Kreis}} = \pi \cdot r^2$

Flächeninhalt des Kreissektors: cm^2

Correct Answers and Answer Frequencies

Math Problem Part	Blank	Correct Answer(s)	Number Correct Answers	Number Incorrect Answers
a)	1	blinded	blinded	blinded
	2	blinded	blinded	blinded
b)	1	blinded	blinded	blinded

Note. Scoring (PCS4): Every correct blank is worth one point (up to 3 points possible).

Item Characteristics

Discrimination					
Measurement Type		Model A5	Model B	Model C	Model D
Correlation to participant ability (θ)		0.82	0.67	0.71	0.73
Discrimination Parameter (α)		1.35	0.86	1.27	1.21
Difficulty					
Measurement Type	Points	Model A5	Model B	Model C	Model D
Difficulty for participant of average ability level	3	0.68	0.81	0.60	0.71
	2	-0.22	-0.29	-0.36	-0.24
	1	-0.54	-0.69	-0.74	-0.59
	0	NA	NA	NA	NA
Cumulative probability for participant of average ability level	3	20.7%	25.1%	25.6%	22.1%
	2	63.4%	62.3%	70.1%	63.6%
	1	79.9%	76.6%	85.6%	79.5%
	0	100%	100%	100%	100%
Frequencies					
Groups	Points	Frequencies		Percent (%)	
Complete sample for this math problem (n = 546)	3	164		30.0%	
	2	156		28.6%	
	1	62		11.4%	
	0	164		30.0%	
Female (n = 167)	3	43		25.7%	
	2	47		28.1%	
	1	16		9.6%	
	0	61		36.5%	
Male (n = 372)	3	121		32.5%	
	2	108		29.0%	
	1	46		12.4%	
	0	97		26.1%	
German as primary language at home (n = 411)	3	117		28.5%	
	2	118		28.7%	
	1	48		11.7%	
	0	128		31.1%	

Frequencies			
Groups	Points	Frequencies	Percent (%)
Other language as primary language at home (n = 133)	3	46	34.6%
	2	38	28.6%
	1	14	10.5%
	0	35	26.3%
Secondary school completed in Germany (n = 490)	3	141	28.8%
	2	139	28.4%
	1	57	11.6%
	0	153	31.2%
Secondary school completed abroad (n = 55)	3	22	40.0%
	2	17	30.9%
	1	5	9.1%
	0	11	20.0%
Math not attended as advanced course in secondary school (n = 188)	3	26	13.8%
	2	39	20.7%
	1	17	9.0%
	0	106	56.4%
Math attended as advanced course in secondary school (n = 319)	3	121	37.9%
	2	107	33.5%
	1	42	13.2%
	0	49	15.4%
No math preparatory course attended (n = 261)	3	66	25.3%
	2	60	23.0%
	1	29	11.1%
	0	106	40.6%
Math preparatory course attended (n = 280)	3	97	34.6%
	2	92	32.9%
	1	33	11.8%
	0	58	20.7%
University of applied sciences (n = 142)	3	22	15.5%
	2	29	20.4%
	1	17	12.0%
	0	74	52.1%
University (n = 404)	3	142	35.1%
	2	127	31.4%
	1	45	11.1%
	0	90	22.3%
Online Participation (n = 393)	3	129	32.8%
	2	106	27.0%
	1	39	9.9%
	0	119	30.3%
Pen-and-Paper Participation (n = 153)	3	35	22.9%
	2	50	32.7%
	1	23	15.0%
	0	45	29.4%

Frequencies			
Groups	Points	Frequencies	Percent (%)
Attended Gymnasium (n = 401)	3	121	30.2%
	2	125	31.2%
	1	48	12.0%
	0	107	26.7%
Attended Other Secondary School (n = 139)	3	40	28.8%
	2	30	21.6%
	1	14	10.1%
	0	55	39.6%

Note. Due to missing values on demographics questions, frequencies within groups may not add up to the total number of responses.

Plots

All plots are generated from **Model A5**.

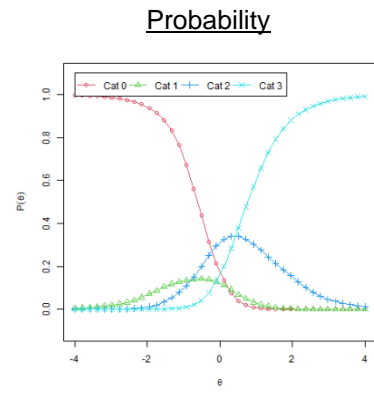
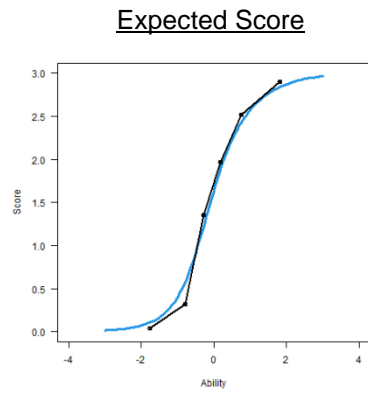
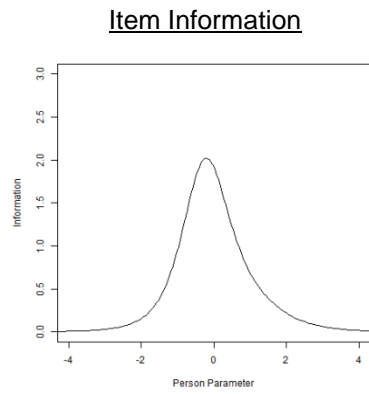

Note. The blue line represents expected performance, and the black line represents actual performance.

Note. Cat n = probability of receiving n points.

Differential Item Functioning (DIF)

This problem shows DIF based on attending math as an advanced or regular course in high school. The difficulty (β) and discrimination (α) parameters were significantly lower for those who attended math as an advanced course. This shows that the problem was significantly easier and less informative for those who took math as an advanced course in high school.

Expected Score (math attended as advanced course in high school)

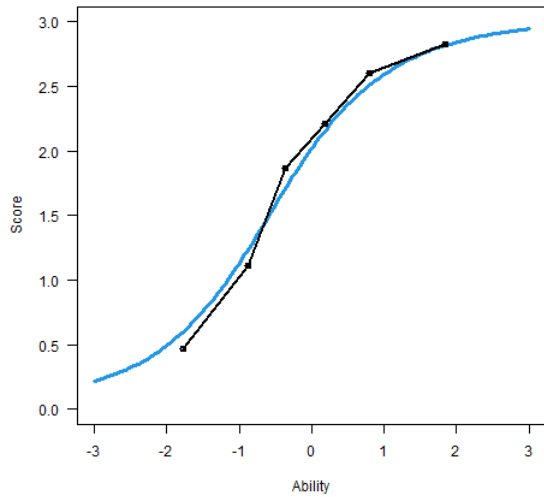

Expected Score (math not attended as advanced course in high school)

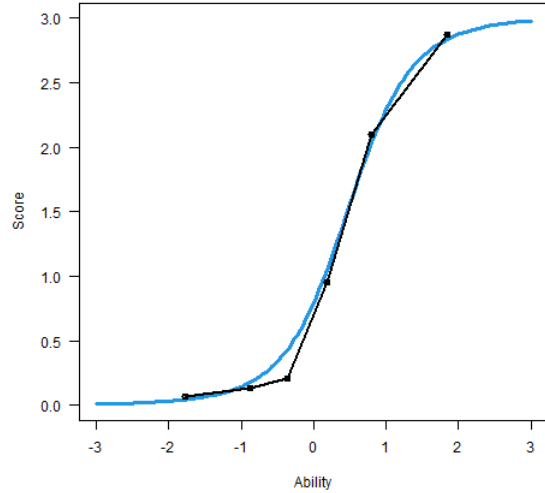

Note. The blue line represents expected performance, and the black line represents actual performance.

4.5.4. Volumes of Standard Figures (G4)

Volumina von Standardkörpern

Berechnen Sie die Volumina der folgenden geometrischen Figuren bzw. geben Sie den zugehörigen Term an.

Ergänzen Sie die freien Felder.

Beachten Sie: π wird als pi eingegeben.

Schreibweise:

*Nutzen Sie folgende Zeichen: + (Addition), - (Subtraktion), * (Multiplikation), / (Division), ^ (Potenz).*

a)

Ein Zylinder mit Durchmesser **2cm** und Höhe **7cm**:

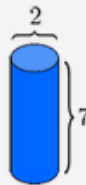

Volumen = cm^3

b)

Eine Kugel mit Radius r :

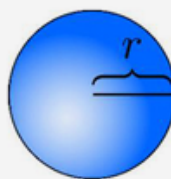

Volumen =

Math Problem ID

G4

Correct Answers and Answer Frequencies

Math Problem Part	Correct Answer(s)	Number Correct Answers	Number Incorrect Answers
a)	blinded	blinded	blinded
b)	blinded	blinded	blinded

Note. Scoring (PCS4): Every correct response is worth one point (up to 2 points possible).

Item Characteristics

Discrimination					
Measurement Type		Model A5	Model B	Model C	Model D
Correlation to participant ability (θ)		0.56	0.49	0.49	0.53
Discrimination Parameter (α)		0.79	0.73	0.92	0.83
Difficulty					
Measurement Type	Points	Model A5	Model B	Model C	Model D
Difficulty for participant of average ability level	2	1.43	1.53	1.22	1.40
	1	-0.64	-0.67	-0.68	-0.62
	0	NA	NA	NA	NA
Cumulative probability for participant of average ability level	2	18.7%	18.8%	19.4%	18.3%
	1	65.3%	64.7%	68.3%	65.3%
	0	100%	100%	100%	100%
Frequencies					
Groups	Points	Frequencies		Percent (%)	
Complete sample for this math problem (n = 572)	2	128		22.4%	
	1	234		40.9%	
	0	210		36.7%	
Female (n = 170)	2	33		19.4%	
	1	64		37.6%	
	0	73		42.9%	
Male (n = 394)	2	95		24.1%	
	1	169		42.9%	
	0	130		33.0%	
German as primary language at home (n = 436)	2	89		20.4%	
	1	189		43.3%	
	0	158		36.2%	
Other language as primary language at home (n = 134)	2	39		29.1%	
	1	45		33.6%	
	0	50		37.3%	
Secondary school completed in Germany (n = 522)	2	115		22.0%	
	1	214		41.0%	
	0	193		37.0%	
Secondary school completed abroad (n = 49)	2	13		26.5%	
	1	20		40.8%	
	0	16		32.7%	

Frequencies			
Groups	Points	Frequencies	Percent (%)
Math not attended as advanced course in secondary school (n = 213)	2	34	16.0%
	1	78	36.6%
	0	101	47.4%
Math attended as advanced course in secondary school (n = 313)	2	80	25.6%
	1	141	45.0%
	0	92	29.4%
No math preparatory course attended (n = 280)	2	58	20.7%
	1	99	35.4%
	0	123	43.9%
Math preparatory course attended (n = 286)	2	68	23.8%
	1	133	46.5%
	0	85	29.7%
University of applied sciences (n = 149)	2	23	15.4%
	1	57	38.3%
	0	69	46.3%
University (n = 423)	2	105	24.8%
	1	177	41.8%
	0	141	33.3%
Online Participation (n = 409)	2	102	24.9%
	1	175	42.8%
	0	132	32.3%
Pen-and-Paper Participation (n = 163)	2	26	16.0%
	1	59	36.2%
	0	78	47.9%
Attended Gymnasium (n = 426)	2	101	23.7%
	1	176	41.3%
	0	149	35.0%
Attended Other Secondary School (n = 141)	2	26	18.4%
	1	56	39.7%
	0	59	41.8%

Note. Due to missing values on demographics questions, frequencies within groups may not add up to the total number of responses.

Plots

All plots are generated from **Model A5**.

Item Information

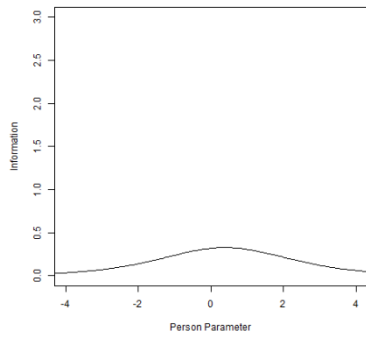

Expected Score

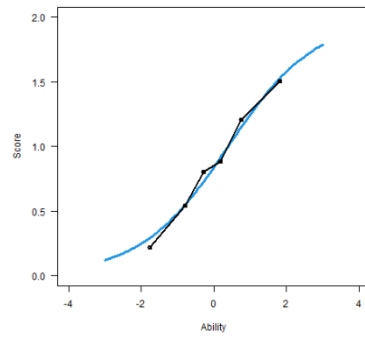

Note. The blue line represents expected performance, and the black line represents actual performance.

Probability

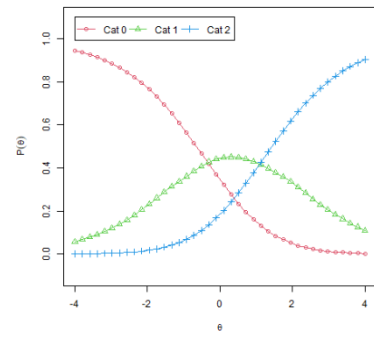

Note. Cat n = probability of receiving n points.

4.5.5. Volume (G5)

Volumen

Bestimmen Sie das Volumen der Figur und wählen Sie die richtige Antwort.

A 5,5
 B 3,5
 C 5,25
 D $4,5 + 1,5 \cdot \sqrt{2}$

Math Problem ID

G5

Correct Answers and Answer Frequencies

Correct Answer	Number Correct Answer	Number Incorrect Answers ^a	Answer Frequencies			
			A	B	C	D
blinded	blinded	blinded	blinded	blinded	blinded	blinded

Note. Scoring (PCS4): Every correct response is worth one point (up to 1 point possible).

^a Includes cases, where the problem was seen but not answered.

Item Characteristics

Discrimination					
Measurement Type		Model A5	Model B	Model C	Model D
Correlation to participant ability (θ)		0.50	0.39	0.40	0.43
Discrimination Parameter (α)		1.18	0.96	1.16	1.15
Difficulty					
Measurement Type	Points	Model A5	Model B	Model C	Model D
Difficulty for participant of average ability level	1	-1.06	-1.20	-1.17	-1.08
	0	NA	NA	NA	NA
Cumulative probability for participant of average ability level	1	77.8%	76.1%	79.5%	77.6%
	0	100%	100%	100%	100%

Frequencies			
Groups	Points	Frequencies	Percent (%)
Complete sample for this math problem (n = 570)	1	414	72.6%
	0	156	27.4%
Female (n = 168)	1	114	67.9%
	0	54	32.1%
Male (n = 394)	1	298	75.6%
	0	96	24.4%
German as primary language at home (n = 434)	1	324	74.7%
	0	110	25.3%
Other language as primary language at home (n = 134)	1	90	67.2%
	0	44	32.8%
Secondary school completed in Germany (n = 520)	1	382	73.5%
	0	138	26.5%
Secondary school completed abroad (n = 49)	1	32	65.3%
	0	17	34.7%
Math not attended as advanced course in secondary school (n = 211)	1	122	57.8%
	0	89	42.2%
Math attended as advanced course in secondary school (n = 313)	1	258	82.4%
	0	55	17.6%
No math preparatory course attended (n = 278)	1	185	66.5%
	0	93	33.5%
Math preparatory course attended (n = 286)	1	227	79.4%
	0	59	20.6%
University of applied sciences (n = 149)	1	79	53.0%
	0	70	47.0%
University (n = 421)	1	335	79.6%
	0	86	20.4%
Online Participation (n = 407)	1	300	73.7%
	0	107	26.3%
Pen-and-Paper Participation (n = 163)	1	114	69.9%
	0	49	30.1%
Attended Gymnasium (n = 425)	1	318	74.8%
	0	107	25.2%
Attended Other Secondary School (n = 140)	1	94	67.1%
	0	46	32.9%

Note. Due to missing values on demographics questions, frequencies within groups may not add up to the total number of responses.

Plots

All plots are generated from **Model A5**.

Item Information

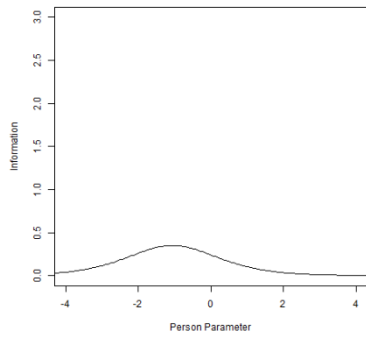

Expected Score

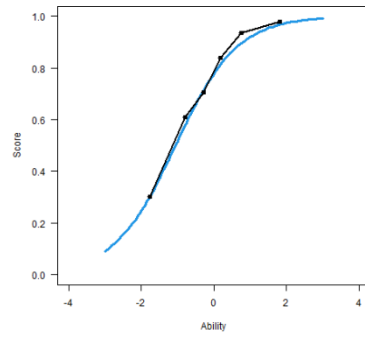

Note. The blue line represents expected performance, and the black line represents actual performance.

Probability

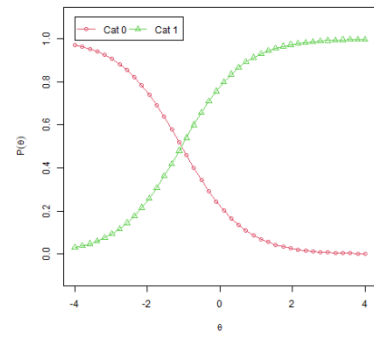

Note. Cat n = probability of receiving n points.

4.5.6. Tangents of Circles (G6)

Kreistangente

Gegeben sei das folgende Bild:

a)
Dass die Gerade BP eine Tangente an den Kreis mit Mittelpunkt M ist, folgt aus...

Wählen Sie die richtige Antwort.

...dem Satz des Pythagoras. A

...dem Satz des Thales. B

...dem Satz über die Innenwinkelsumme. C

...dem Satz von Bayes. D

b)
Berechnen Sie die Länge der Strecke \overline{BP} .

Ergänzen Sie das freie Feld.

Die Länge beträgt:

Math Problem ID

G6

Correct Answers and Answer Frequencies

Math Problem Part	Correct Answer(s)	Number Correct Answers	Number Incorrect Answers ^a	Answer Frequencies			
				A	B	C	D
a)	blinded	blinded	blinded	blinded	blinded	blinded	blinded
b)	blinded	blinded	blinded	-	-	-	-

Note. Scoring (PCS4): Every correct response is worth one point (up to 2 points possible).

^a Includes cases, where the problem was seen but not answered.

Item Characteristics

Discrimination					
Measurement Type		Model A5	Model B	Model C	Model D
Correlation to participant ability (θ)		0.58	0.46	0.48	0.50
Discrimination Parameter (α)		0.90	0.77	0.98	0.89
Difficulty					
Measurement Type	Points	Model A5	Model B	Model C	Model D
Difficulty for participant of average ability level	2	2.10	2.37	1.92	2.13
	1	-0.63	-0.69	-0.70	-0.63
	0	NA	NA	NA	NA
Cumulative probability for participant of average ability level	2	9.2%	9.8%	9.6%	9.2%
	1	65.4%	64.5%	68.0%	65.2%
	0	100%	100%	100%	100%
Frequencies					
Groups	Points	Frequencies		Percent (%)	
Complete sample for this math problem (n = 565)	2	74		13.1%	
	1	283		50.1%	
	0	208		36.8%	
Female (n = 166)	2	14		8.4%	
	1	82		49.4%	
	0	70		42.2%	
Male (n = 391)	2	60		15.3%	
	1	200		51.2%	
	0	131		33.5%	
German as primary language at home (n = 430)	2	61		14.2%	
	1	220		51.2%	
	0	149		34.7%	
Other language as primary language at home (n = 133)	2	13		9.8%	
	1	62		46.6%	
	0	58		43.6%	
Secondary school completed in Germany (n = 516)	2	70		13.6%	
	1	257		49.8%	
	0	189		36.6%	
Secondary school completed abroad (n = 48)	2	4		8.3%	
	1	26		54.2%	
	0	18		37.5%	
Math not attended as advanced course in secondary school (n = 208)	2	9		4.3%	
	1	101		48.6%	
	0	98		47.1%	
Math attended as advanced course in secondary school (n = 311)	2	58		18.6%	
	1	160		51.4%	
	0	93		29.9%	

Frequencies			
Groups	Points	Frequencies	Percent (%)
No math preparatory course attended (n = 274)	2	35	12.8%
	1	127	46.4%
	0	112	40.9%
Math preparatory course attended (n = 285)	2	38	13.3%
	1	153	53.7%
	0	94	33.0%
University of applied sciences (n = 149)	2	6	4.0%
	1	75	50.3%
	0	68	45.6%
University (n = 416)	2	68	16.3%
	1	208	50.0%
	0	140	33.7%
Online Participation (n = 402)	2	49	12.2%
	1	208	51.7%
	0	145	36.1%
Pen-and-Paper Participation (n = 163)	2	25	15.3%
	1	75	46.0%
	0	63	38.7%
Attended Gymnasium (n = 420)	2	65	15.5%
	1	215	51.2%
	0	140	33.3%
Attended Other Secondary School (n = 140)	2	7	5.0%
	1	66	47.1%
	0	67	47.9%

Note. Due to missing values on demographics questions, frequencies within groups may not add up to the total number of responses.

Plots

All plots are generated from **Model A5**.

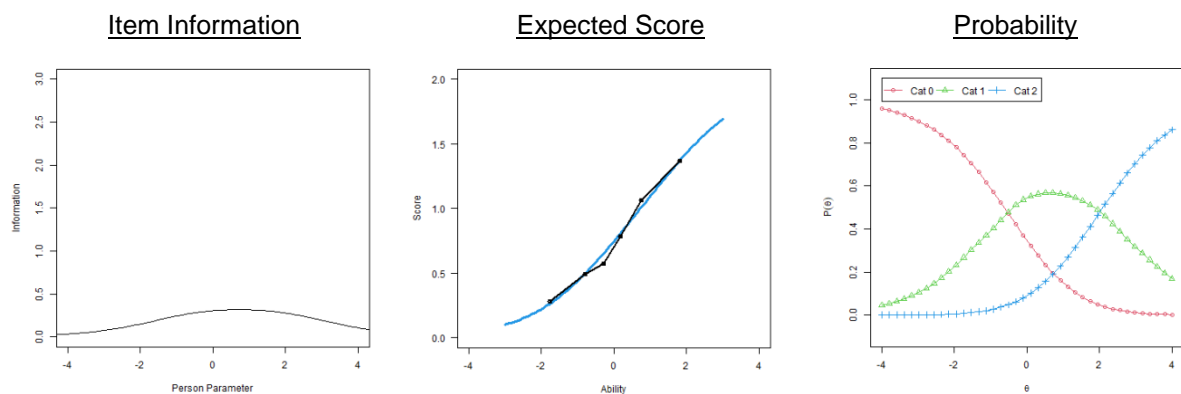

Note. The blue line represents expected performance, and the black line represents actual performance.

Note. Cat n = probability of receiving n points.

4.5.7. Similarity and Radius Ratios (G7)

Ähnlichkeit und Radiusverhältnisse

Ein gerader Kegel der Höhe a hat als Grundfläche einen Kreis mit Radius r . In Höhe von b liegt parallel ein weiterer kleiner Kreis (rot). Welchen Radius g hat der kleine (rote) Kreis?

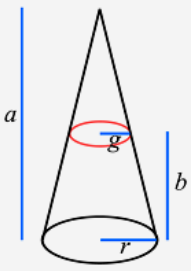

Ergänzen Sie das freie Feld.

Schreibweise:
Nutzen Sie folgende Zeichen: + (Addition), - (Subtraktion), * (Multiplikation), / (Division), ^ (Potenz).

$g =$

Math Problem ID

G7

Correct Answers and Answer Frequencies

Correct Answer(s)	Number Correct Answers	Number Incorrect Answers
blinded	blinded	blinded

Note. Scoring (PCS4): Every correct response is worth one point (up to 1 point possible).

Item Characteristics

Discrimination					
Measurement Type		Model A5	Model B	Model C	Model D
Correlation to participant ability (θ)		0.47	0.39	0.41	0.42
Discrimination Parameter (α)		1.83	1.57	1.88	1.93
Difficulty					
Measurement Type	Points	Model A5	Model B	Model C	Model D
Difficulty for participant of average ability level	1	1.95	2.13	1.87	1.91
	0	NA	NA	NA	NA
Cumulative probability for participant of average ability level	1	2.7%	3.4%	2.9%	2.4%
	0	100%	100%	100%	100%

Frequencies			
Groups	Points	Frequencies	Percent (%)
Complete sample for this math problem (n = 540)	1	45	8.3%
	0	495	91.7%
Female (n = 167)	1	11	6.6%
	0	156	93.4%
Male (n = 366)	1	34	9.3%
	0	332	90.7%
German as primary language at home (n = 410)	1	27	6.6%
	0	383	93.4%
Other language as primary language at home (n = 129)	1	18	14.0%
	0	111	86.0%
Secondary school completed in Germany (n = 487)	1	32	6.6%
	0	455	93.4%
Secondary school completed abroad (n = 53)	1	13	24.5%
	0	40	75.5%
Math not attended as advanced course in secondary school (n = 184)	1	9	4.9%
	0	175	95.1%
Math attended as advanced course in secondary school (n = 317)	1	29	9.1%
	0	288	90.9%
No math preparatory course attended (n = 258)	1	22	8.5%
	0	236	91.5%
Math preparatory course attended (n = 277)	1	22	7.9%
	0	255	92.1%
University of applied sciences (n = 141)	1	3	2.1%
	0	138	97.9%
University (n = 399)	1	42	10.5%
	0	357	89.5%
Online Participation (n = 389)	1	29	7.5%
	0	360	92.5%
Pen-and-Paper Participation (n = 151)	1	16	10.6%
	0	135	89.4%
Attended Gymnasium (n = 397)	1	29	7.3%
	0	368	92.7%
Attended Other Secondary School (n = 137)	1	15	10.9%
	0	122	89.1%

Note. Due to missing values on demographics questions, frequencies within groups may not add up to the total number of responses.

Plots

All plots are generated from **Model A5**.

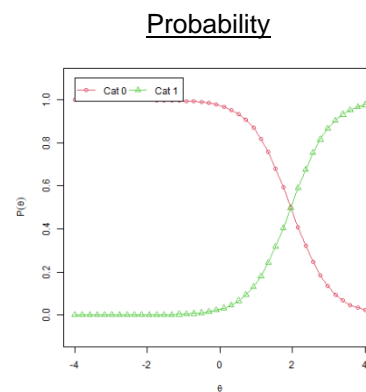
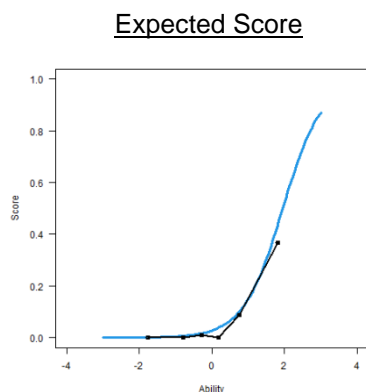
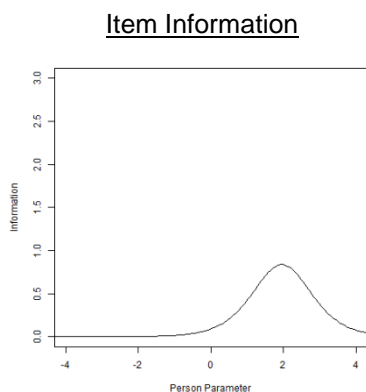

Note. The blue line represents expected performance, and the black line represents actual performance.

Note. Cat n = probability of receiving n points.

4.5.8. Statements About Congruence (G8)

Kongruenzsätze

Welche dieser Aussagen sind wahr?

Hinweis: Kongruent ist gleichbedeutend zu deckungsgleich und heißt: durch Verschiebungen, Drehungen, Spiegelungen oder Kombinationen hiervon auseinander hervorgehend.

Wählen Sie eine oder mehrere richtige Antworten.

Zwei Dreiecke, die in zwei Seitenlängen und dem eingeschlossenen Winkel übereinstimmen, sind kongruent.

Zwei Dreiecke, die in allen drei Seitenlängen übereinstimmen, sind kongruent.

Zwei Dreiecke, die in einer Seitenlänge und irgendwelchen zwei Winkeln übereinstimmen, sind kongruent.

Math Problem ID

G8

Correct Answers and Answer Frequencies

Answer	Correct Answer(s)	Number Correct Answers	Number Incorrect Answers
Zwei Dreiecke, die in zwei Seitenlängen und dem eingeschlossenen Winkel übereinstimmen, sind kongruent.	blinded	blinded	blinded
Zwei Dreiecke, die in allen drei Seitenlängen übereinstimmen, sind kongruent.	blinded	blinded	blinded
Zwei Dreiecke, die in einer Seitenlänge und irgendwelchen zwei Winkeln übereinstimmen, sind kongruent.	blinded	blinded	blinded

Note. Scoring (PCS4): Every correct response and correct rejection is worth one point (up to 3 points possible).

Item Characteristics

Discrimination					
Measurement Type		Model A5	Model B	Model C	Model D
Correlation to participant ability (θ)		0.39	0.29	0.32	0.32
Discrimination Parameter (α)		0.40	0.30	0.55	0.37
Difficulty					
Measurement Type	Points	Model A5	Model B	Model C	Model D
Difficulty for participant of average ability level	3	1.10	1.43	0.76	1.19
	2	-1.38	-1.84	-1.28	-1.52
	1	-3.29	-4.35	-3.24	-3.61
	0	NA	NA	NA	NA
Cumulative probability for participant of average ability level	3	34.5%	35.1%	36.0%	34.8%
	2	73.0%	72.7%	76.1%	73.0%
	1	91.7%	91.2%	95.5%	91.6%
	0	100%	100%	100%	100%
Frequencies					
Groups	Points	Frequencies	Percent (%)		
Complete sample for this math problem (n = 542)	3	193	35.6%		
	2	196	36.2%		
	1	100	18.5%		
	0	53	9.8%		
Female (n = 167)	3	59	35.3%		
	2	61	36.5%		
	1	29	17.4%		
	0	18	10.8%		
Male (n = 368)	3	131	35.6%		
	2	132	35.9%		
	1	71	19.3%		
	0	34	9.2%		
German as primary language at home (n = 410)	3	148	36.1%		
	2	155	37.8%		
	1	77	18.8%		
	0	30	7.3%		
Other language as primary language at home (n = 130)	3	44	33.8%		
	2	41	31.5%		
	1	22	16.9%		
	0	23	17.7%		
Secondary school completed in Germany (n = 487)	3	177	36.3%		
	2	175	35.9%		
	1	91	18.7%		
	0	44	9.0%		

Frequencies			
Groups	Points	Frequencies	Percent (%)
Secondary school completed abroad (n = 54)	3	15	27.8%
	2	21	38.9%
	1	9	16.7%
	0	9	16.7%
Math not attended as advanced course in secondary school (n = 185)	3	50	27.0%
	2	64	34.6%
	1	36	19.5%
	0	35	18.9%
Math attended as advanced course in secondary school (n = 318)	3	133	41.8%
	2	113	35.5%
	1	58	18.2%
	0	14	4.4%
No math preparatory course attended (n = 258)	3	88	34.1%
	2	93	36.0%
	1	42	16.3%
	0	35	13.6%
Math preparatory course attended (n = 279)	3	103	36.9%
	2	102	36.6%
	1	57	20.4%
	0	17	6.1%
University of applied sciences (n = 141)	3	40	28.4%
	2	48	34.0%
	1	27	19.1%
	0	26	18.4%
University (n = 401)	3	153	38.2%
	2	148	36.9%
	1	73	18.2%
	0	27	6.7%
Online Participation (n = 391)	3	141	36.1%
	2	147	37.6%
	1	68	17.4%
	0	35	9.0%
Pen-and-Paper Participation (n = 151)	3	52	34.4%
	2	49	32.5%
	1	32	21.2%
	0	18	11.9%
Attended Gymnasium (n = 399)	3	151	37.8%
	2	142	35.6%
	1	78	19.5%
	0	28	7.0%
Attended Other Secondary School (n = 137)	3	41	29.9%
	2	52	38.0%
	1	21	15.3%
	0	23	16.8%

Note. Due to missing values on demographics questions, frequencies within groups may not add up to the total number of responses.

Plots

All plots are generated from **Model A5**.

Item Information

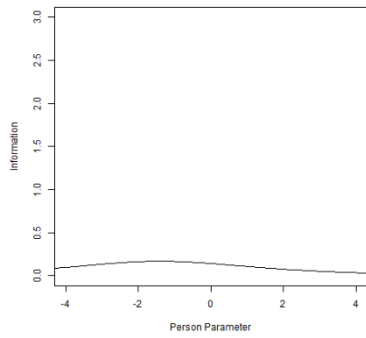

Expected Score

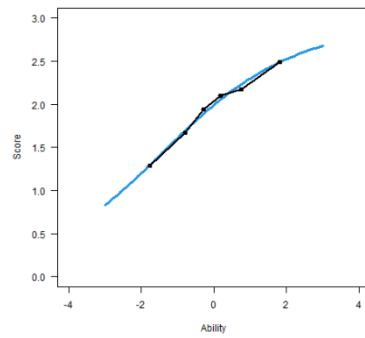

Note. The blue line represents expected performance, and the black line represents actual performance.

Probability

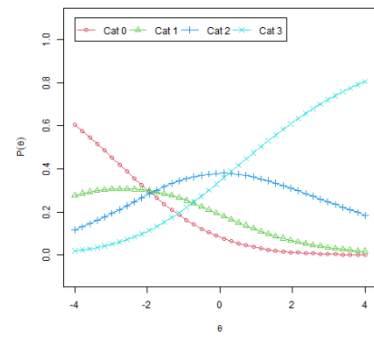

Note. Cat n = probability of receiving n points.

4.5.9. Symmetry (G9)



Math Problem ID

G9

Changes to the Problem After the Main Study

This problem was changed after the main study. The reason for the implemented changes and results of qualitative interviews testing the revised version are reported in **Section 5**.

Correct Answers and Answer Frequencies

Answer	Correct Answer(s)	Number Correct Answers	Number Incorrect Answers
1. Answer Option	blinded	blinded	blinded
2. Answer Option	blinded	blinded	blinded
3. Answer Option	blinded	blinded	blinded
4. Answer Option	blinded	blinded	blinded

Note. Scoring (PCS4): Every correct response and correct rejection is worth one point (up to 4 points possible).

Item Characteristics

Discrimination					
Measurement Type		Model A5	Model B	Model C	Model D
Correlation to participant ability (θ)		0.39	0.26	0.32	0.29
Discrimination Parameter (α)		0.45	0.31	0.76	0.40
Difficulty					
Measurement Type	Points	Model A5	Model B	Model C	Model D
Difficulty for participant of average ability level	4	0.23	0.30	0.06	0.24
	3	-2.35	-3.14	-2.17	-2.54
	2	-3.16	-4.20	-3.77	-3.41
	1	-3.30	-4.38	-4.91	-3.56
	0	NA	NA	NA	NA
Cumulative probability for participant of average ability level	4	46.9%	47.1%	48.7%	47.0%
	3	89.1%	88.3%	91.7%	88.9%
	2	98.4%	97.8%	99.6%	98.2%
	1	98.8%	98.3%	100%	98.7%
	0	100%	100%	100%	100%
Frequencies					
Groups	Points	Frequencies		Percent (%)	
Complete sample for this math problem (n = 526)	4	249		47.3%	
	3	210		39.9%	
	2	51		9.7%	
	1	3		0.6%	
	0	13		2.5%	
Female (n = 162)	4	79		48.8%	
	3	60		37.0%	
	2	17		10.5%	
	1	3		1.9%	
	0	3		1.9%	
Male (n = 357)	4	168		47.1%	
	3	146		40.9%	
	2	34		9.5%	
	1	0		0.0%	
	0	9		2.5%	
German as primary language at home (n = 400)	4	202		50.5%	
	3	150		37.5%	
	2	36		9.0%	
	1	1		0.3%	
	0	11		2.8%	

Frequencies			
Groups	Points	Frequencies	Percent (%)
Other language as primary language at home (n = 124)	4	46	37.1%
	3	59	47.6%
	2	15	12.1%
	1	2	1.6%
	0	2	1.6%
Secondary school completed in Germany (n = 471)	4	224	47.6%
	3	187	39.7%
	2	46	9.8%
	1	3	0.6%
	0	11	2.3%
Secondary school completed abroad (n = 54)	4	24	44.4%
	3	23	42.6%
	2	5	9.3%
	1	0	0.0%
	0	2	3.7%
Math not attended as advanced course in secondary school (n = 174)	4	66	37.9%
	3	80	46.0%
	2	23	13.2%
	1	0	0.0%
	0	5	2.9%
Math attended as advanced course in secondary school (n = 315)	4	166	52.7%
	3	115	36.5%
	2	26	8.3%
	1	3	1.0%
	0	5	1.6%
No math preparatory course attended (n = 255)	4	107	42.0%
	3	115	45.1%
	2	27	10.6%
	1	2	0.8%
	0	4	1.6%
Math preparatory course attended (n = 266)	4	138	51.9%
	3	95	35.7%
	2	23	8.6%
	1	1	0.4%
	0	9	3.4%
University of applied sciences (n = 124)	4	41	33.1%
	3	60	48.4%
	2	18	14.5%
	1	0	0.0%
	0	5	4.0%
University (n = 402)	4	208	51.7%
	3	150	37.3%
	2	33	8.2%
	1	3	0.7%
	0	8	2.0%

Frequencies			
Groups	Points	Frequencies	Percent (%)
Online Participation (n = 375)	4	171	45.6%
	3	159	42.4%
	2	33	8.8%
	1	2	0.5%
	0	10	2.7%
Pen-and-Paper Participation (n = 151)	4	78	51.7%
	3	51	33.8%
	2	18	11.9%
	1	1	0.7%
	0	3	2.0%
Attended Gymnasium (n = 392)	4	197	50.3%
	3	149	38.0%
	2	35	8.9%
	1	2	0.5%
	0	9	2.3%
Attended Other Secondary School (n = 128)	4	49	38.3%
	3	59	46.1%
	2	15	11.7%
	1	1	0.8%
	0	4	3.1%

Note. Due to missing values on demographics questions, frequencies within groups may not add up to the total number of responses.

Plots

All plots are generated from **Model A5**.

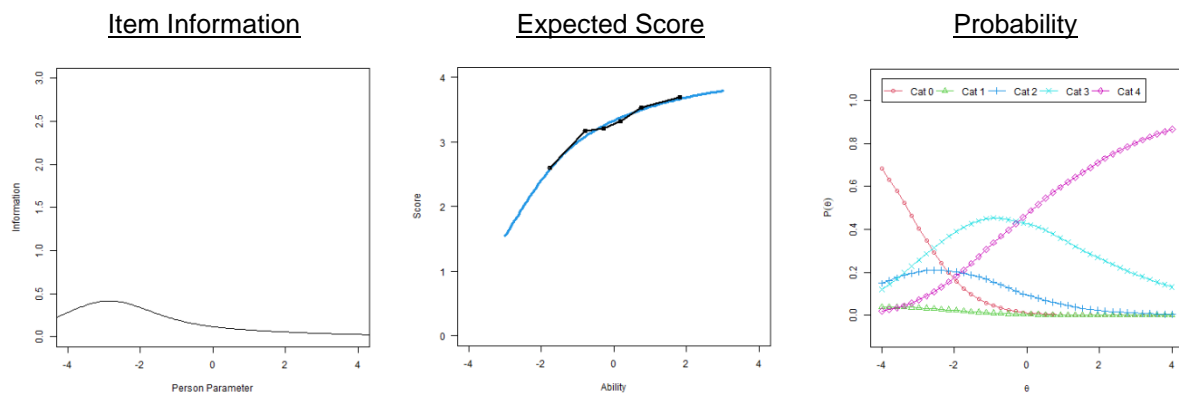

Note. The blue line represents expected performance, and the black line represents actual performance.

Note. Cat n = probability of receiving n points.

4.5.10. Homothety (G10)

Zentrische Streckung

Das Dreieck $A'B'C'$ ist durch zentrische Streckung des Dreiecks ABC um den Faktor $k > 1$ und das Zentrum Z gestreckt.
 Welche der folgenden Aussagen sind wahr?

Wählen Sie eine oder mehrere richtige Antworten.

Der Flächeninhalt des Dreiecks ABC ist k -mal so groß wie der vom Dreieck $A'B'C'$.

Die Strecke $\overline{A'B'}$ ist k -mal so lang wie die Strecke \overline{AB} .

Die zentrische Streckung ist nicht winkelgetreu, das heißt mindestens einer der Winkel an A, B oder C ist verschieden zu dem Winkel an A', B' beziehungsweise C' .

Math Problem ID

G10

Correct Answers and Answer Frequencies

Answer	Correct Answer(s)	Number Correct Answers	Number Incorrect Answers
Der Flächeninhalt des Dreiecks ABC ist k -mal so groß wie der vom Dreieck $A'B'C'$.	blinded	blinded	blinded
Die Strecke $\overline{A'B'}$ ist k -mal so lang wie die Strecke \overline{AB} .	blinded	blinded	blinded
Die zentrische Streckung ist nicht winkelgetreu, das heißt mindestens einer der Winkel an A, B oder C ist verschieden zu dem Winkel an A', B' beziehungsweise C' .	blinded	blinded	blinded

Note. Scoring (PCS4): A previous version of this problem was programmed as a single-choice item. To merge both versions, only the correct answer is evaluated. That is, correctly choosing Option 2 is worth 1 point (up to 1 point possible).

Item Characteristics

Discrimination					
Measurement Type		Model A5	Model B	Model C	Model D
Correlation to participant ability (θ)		0.50	0.36	0.38	0.40
Discrimination Parameter (α)		1.22	0.90	1.16	1.13
Difficulty					
Measurement Type	Points	Model A5	Model B	Model C	Model D
Difficulty for participant of average ability level	1	-1.21	-1.46	-1.33	-1.26
	0	NA	NA	NA	NA
Cumulative probability for participant of average ability level	1	81.3%	78.9%	82.3%	80.5%
	0	100%	100%	100%	100%
Frequencies					
Groups	Points	Frequencies		Percent (%)	
Complete sample for this math problem (n = 543)	1	414		76.2%	
	0	129		23.8%	
Female (n = 161)	1	120		74.5%	
	0	41		25.5%	
Male (n = 374)	1	292		78.1%	
	0	82		21.9%	
German as primary language at home (n = 416)	1	322		77.4%	
	0	94		22.6%	
Other language as primary language at home (n = 125)	1	92		73.6%	
	0	33		26.4%	
Secondary school completed in Germany (n = 495)	1	382		77.2%	
	0	113		22.8%	
Secondary school completed abroad (n = 47)	1	32		68.1%	
	0	15		31.9%	
Math not attended as advanced course in secondary school (n = 191)	1	131		68.6%	
	0	60		31.4%	
Math attended as advanced course in secondary school (n = 307)	1	253		82.4%	
	0	54		17.6%	
No math preparatory course attended (n = 269)	1	194		72.1%	
	0	75		27.9%	
Math preparatory course attended (n = 269)	1	218		81.0%	
	0	51		19.0%	
University of applied sciences (n = 129)	1	80		62.0%	
	0	49		38.0%	
University (n = 414)	1	334		80.7%	
	0	80		19.3%	
Online Participation (n = 380)	1	282		74.2%	
	0	98		25.8%	
Pen-and-Paper Participation (n = 163)	1	132		81.0%	
	0	31		19.0%	

Frequencies			
Groups	Points	Frequencies	Percent (%)
Attended Gymnasium (n = 408)	1	319	78.2%
	0	89	21.8%
Attended Other Secondary School (n = 130)	1	91	70.0%
	0	39	30.0%

Note. Due to missing values on demographics questions, frequencies within groups may not add up to the total number of responses.

Plots

All plots are generated from **Model A5**.

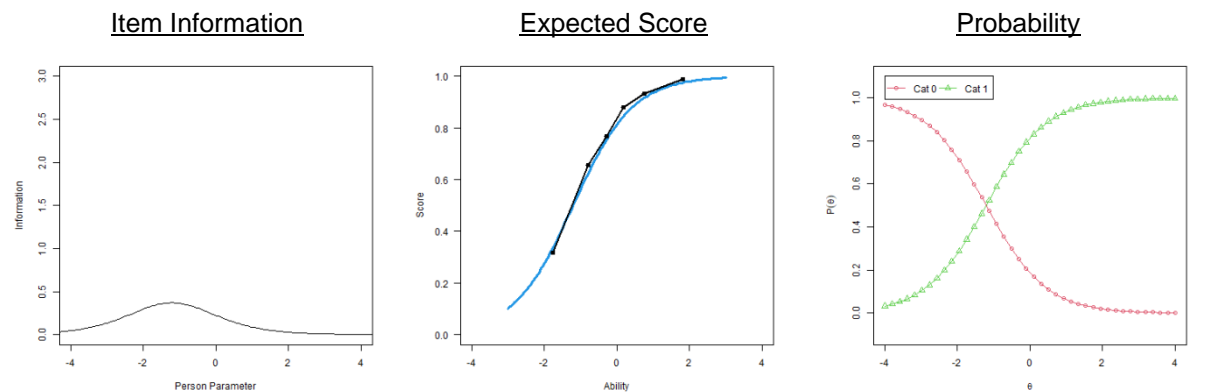

Note. The blue line represents expected performance, and the black line represents actual performance.

Note. Cat n = probability of receiving n points.

4.6. Trigonometry (Trigonometrie; TR)

Q₃ Statistics for Trigonometry

	TR1	TR2	TR3	TR4	TR5	TR6	TR7	TR8	TR9	TR10
TR1	-									
TR2	-.061	-								
TR3	-.287	-.165	-							
TR4	-.253	-.140	-.191	-						
TR5	-.234	-.013	-.164	-.185	-					
TR6	.024	-.165	-.151	-.272	-.042	-				
TR7	-.086	-.013	-.153	-.210	.050	-.097	-			
TR8	-.193	-.241	-.056	-.068	.139	-.089	.166	-		
TR9	-.158	-.039	-.057	-.102	-.047	-.067	-.146	-.027	-	
TR10	-.168	-.090	-.114	-.118	-.046	-.139	.041	.018	-.077	

Note. Q₃ statistics above the critical absolute value of 0.20 are bolded. For details see **Section 3.1**.

4.6.1. Aspect Ratios in a Right Triangle (TR1)

Seitenverhältnisse im rechtwinkligen Dreieck

Wie lauten die Definitionen für Sinus, Kosinus und Tangens im rechtwinkligen Dreieck?

Wählen Sie jeweils die richtige Antwort.

a)

$\sin(\alpha) =$

A	$\frac{\text{Ankathete}}{\text{Gegenkathete}}$	D	$\frac{\text{Hypotenuse}}{\text{Gegenkathete}}$
B	$\frac{\text{Gegenkathete}}{\text{Ankathete}}$	E	$\frac{\text{Ankathete}}{\text{Hypotenuse}}$
C	$\frac{\text{Gegenkathete}}{\text{Hypotenuse}}$	F	$\frac{\text{Hypotenuse}}{\text{Ankathete}}$

b)

$\cos(\alpha) =$

A	$\frac{\text{Ankathete}}{\text{Gegenkathete}}$	D	$\frac{\text{Hypotenuse}}{\text{Gegenkathete}}$
B	$\frac{\text{Gegenkathete}}{\text{Ankathete}}$	E	$\frac{\text{Ankathete}}{\text{Hypotenuse}}$
C	$\frac{\text{Gegenkathete}}{\text{Hypotenuse}}$	F	$\frac{\text{Hypotenuse}}{\text{Ankathete}}$

c)

$$\tan(\alpha) =$$

A	$\frac{\text{Ankathete}}{\text{Gegenkathete}}$	D	$\frac{\text{Hypotenuse}}{\text{Gegenkathete}}$
B	$\frac{\text{Gegenkathete}}{\text{Ankathete}}$	E	$\frac{\text{Ankathete}}{\text{Hypotenuse}}$
C	$\frac{\text{Gegenkathete}}{\text{Hypotenuse}}$	F	$\frac{\text{Hypotenuse}}{\text{Ankathete}}$

Math Problem ID

TR1

Correct Answers and Answer Frequencies

Math Problem Part	Correct Answer	Number Correct Answers	Number Incorrect Answers ^a	Answer Frequencies					
				A	B	C	D	E	F
a)	blinded	blinded	blinded	blinded	blinded
b)	blinded	blinded	blinded	blinded	blinded
c)	blinded	blinded	blinded	blinded	blinded

Note. Scoring (PCS4): Every correct response is worth one point (up to 3 points possible).

^a Includes cases, where the problem was seen but not answered.

Item Characteristics

Discrimination					
Measurement Type		Model A6	Model B	Model C	Model D
Correlation to participant ability (θ)		0.69	0.62	0.62	0.63
Discrimination Parameter (α)		0.94	0.79	0.85	0.92
Difficulty					
Measurement Type	Points	Model A6	Model B	Model C	Model D
Difficulty for participant of average ability level	3	-0.19	-0.22	-0.34	-0.20
	2	-0.48	-0.53	-0.68	-0.49
	1	-0.74	-0.82	-1.05	-0.76
	0	NA	NA	NA	NA
Cumulative probability for participant of average ability level	3	59.0%	59.0%	64.0%	59.4%
	2	74.9%	74.0%	79.6%	75.1%
	1	84.1%	82.9%	89.1%	84.2%
	0	100%	100%	100%	100%

Frequencies			
Groups	Points	Frequencies	Percent (%)
Complete sample for this math problem (n = 545)	3	296	54.3%
	2	61	11.2%
	1	44	8.1%
	0	144	26.4%
Female (n = 163)	3	89	54.6%
	2	20	12.3%
	1	12	7.4%
	0	42	25.8%
Male (n = 374)	3	203	54.3%
	2	41	11.0%
	1	31	8.3%
	0	99	26.5%
German as primary language at home (n = 418)	3	218	52.2%
	2	48	11.5%
	1	34	8.1%
	0	118	28.2%
Other language as primary language at home (n = 122)	3	77	63.1%
	2	13	10.7%
	1	9	7.4%
	0	23	18.9%
Secondary school completed in Germany (n = 501)	3	265	52.9%
	2	56	11.2%
	1	41	8.2%
	0	139	27.7%
Secondary school completed abroad (n = 41)	3	30	73.2%
	2	5	12.2%
	1	2	4.9%
	0	4	9.8%
Math not attended as advanced course in secondary school (n = 200)	3	75	37.5%
	2	19	9.5%
	1	21	10.5%
	0	85	42.5%
Math attended as advanced course in secondary school (n = 300)	3	193	64.3%
	2	36	12.0%
	1	17	5.7%
	0	54	18.0%
No math preparatory course attended (n = 262)	3	134	51.1%
	2	28	10.7%
	1	25	9.5%
	0	75	28.6%
Math preparatory course attended (n = 278)	3	159	57.2%
	2	33	11.9%
	1	18	6.5%
	0	68	24.5%

Frequencies			
Groups	Points	Frequencies	Percent (%)
University of applied sciences (n = 140)	3	56	40.0%
	2	15	10.7%
	1	15	10.7%
	0	54	38.6%
University (n = 405)	3	240	59.3%
	2	46	11.4%
	1	29	7.2%
	0	90	22.2%
Online Participation (n = 374)	3	219	58.6%
	2	45	12.0%
	1	28	7.5%
	0	82	21.9%
Pen-and-Paper Participation (n = 171)	3	77	45.0%
	2	16	9.4%
	1	16	9.4%
	0	62	36.3%
Attended Gymnasium (n = 405)	3	226	55.8%
	2	50	12.3%
	1	31	7.7%
	0	98	24.2%
Attended Other Secondary School (n = 134)	3	68	50.7%
	2	11	8.2%
	1	12	9.0%
	0	43	32.1%

Note. Due to missing values on demographics questions, frequencies within groups may not add up to the total number of responses.

Plots

All plots are generated from **Model A6**.

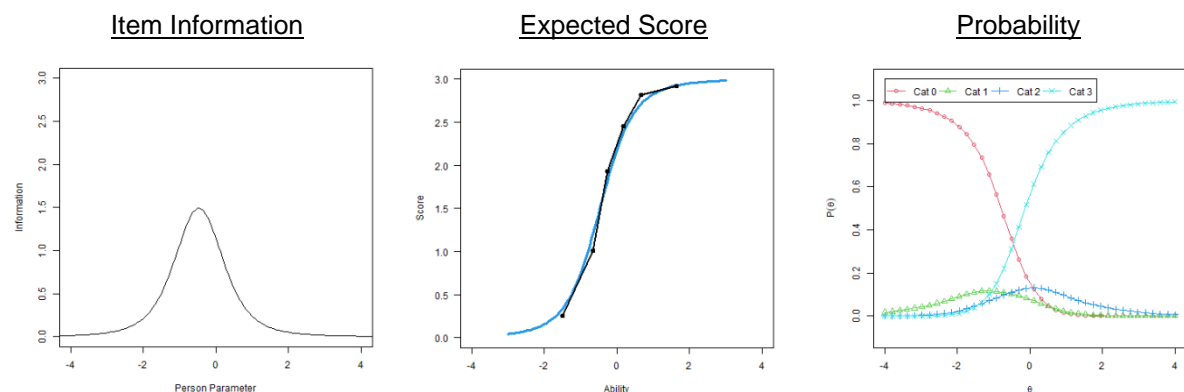

Note. The blue line represents expected performance, and the black line represents actual performance.

Note. Cat n = probability of receiving n points.

4.6.2. Sine and Cosine in the Unit Circle (TR2)

Version 1:

Sinus und Kosinus am Einheitskreis

Wählen Sie jeweils die Gleichungen der folgenden Darstellungen am Einheitskreis.

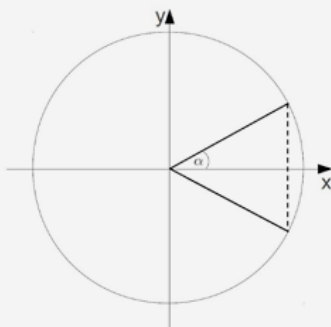

a)

A $\sin(-\alpha) = -\sin(\alpha)$

$\sin(\alpha) = -\sin(180^\circ + \alpha)$

B $\cos(\alpha) = \sin(90^\circ - \alpha)$

D $\cos(\alpha) = -\cos(180^\circ - \alpha)$

C $\cos(\alpha) = \cos(360^\circ + \alpha)$

b)

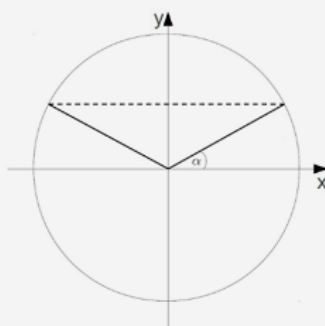

A $\sin(-\alpha) = -\sin(\alpha)$

$\sin(\alpha) = -\sin(180^\circ + \alpha)$

B $\cos(\alpha) = \sin(90^\circ - \alpha)$

D $\cos(\alpha) = -\cos(180^\circ - \alpha)$

C $\cos(\alpha) = \cos(360^\circ + \alpha)$

c)

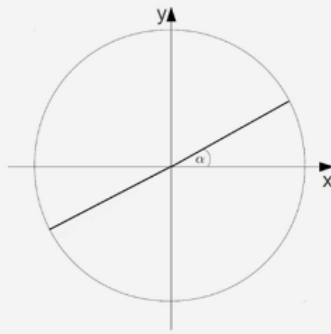

A $\sin(-\alpha) = -\sin(\alpha)$

$\sin(\alpha) = -\sin(180^\circ + \alpha)$

B $\cos(\alpha) = \sin(90^\circ - \alpha)$

D $\cos(\alpha) = -\cos(180^\circ - \alpha)$

C $\cos(\alpha) = \cos(360^\circ + \alpha)$

Version 2:

Sinus und Kosinus am Einheitskreis

Wählen Sie jeweils die Gleichungen der folgenden Darstellungen am Einheitskreis.

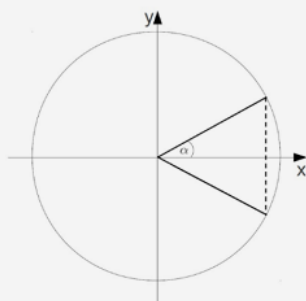

a)

A $\sin(-\alpha) = -\sin(\alpha)$

C $\cos(\alpha) = \cos(360^\circ + \alpha)$

B $\cos(\alpha) = \sin(90^\circ - \alpha)$

D $\cos(\alpha) = -\cos(180^\circ - \alpha)$

b)

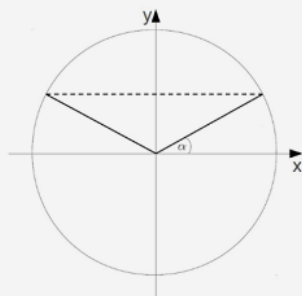

A $\sin(-\alpha) = -\sin(\alpha)$

C $\cos(\alpha) = \cos(360^\circ + \alpha)$

B $\cos(\alpha) = \sin(90^\circ - \alpha)$

D $\cos(\alpha) = -\cos(180^\circ - \alpha)$

Math Problem ID

TR2

Correct Answers and Answer Frequencies

Math Problem Part	Correct Answer	Number Correct Answers	Number Incorrect Answers ^a	Answer Frequencies			
				A	B	C	D
a)	blinded	blinded	blinded	blinded	blinded	blinded	blinded
b)	blinded	blinded	blinded	blinded	blinded	blinded	blinded

Note. Scoring (PCS4): Version 1, Part c) is dropped from scoring to match with Version 2. Every correct response is worth one point (up to 2 points possible). The distractor “sin (α) = sin(180 + a)” is removed in Version 2. This answer option was only chosen once on Part b) in Version 1, and never on Part a).

^a Includes cases, where the problem was seen but not answered.

Item Characteristics

Discrimination					
Measurement Type		Model A6	Model B	Model C	Model D
Correlation to participant ability (θ)		0.53	0.44	0.44	0.44
Discrimination Parameter (α)		0.72	0.61	0.56	0.66
Difficulty					
Measurement Type	Points	Model A6	Model B	Model C	Model D
Difficulty for participant of average ability level	2	1.39	1.59	1.61	1.50
	1	-0.31	-0.31	-0.46	-0.30
	0	NA	NA	NA	NA
Cumulative probability for participant of average ability level	2	19.6%	19.9%	21.7%	19.6%
	1	57.2%	56.4%	58.6%	56.5%
	0	100%	100%	100%	100%
Frequencies					
Groups	Points	Frequencies		Percent (%)	
Complete sample for this math problem (n = 541)	2	126		23.3%	
	1	181		33.5%	
	0	234		43.3%	
Female (n = 162)	2	31		19.1%	
	1	54		33.3%	
	0	77		47.5%	
Male (n = 373)	2	94		25.2%	
	1	126		33.8%	
	0	153		41.0%	
German as primary language at home (n = 406)	2	88		21.7%	
	1	143		35.2%	
	0	175		43.1%	
Other language as primary language at home (n = 129)	2	36		27.9%	
	1	37		28.7%	
	0	56		43.4%	

Frequencies			
Groups	Points	Frequencies	Percent (%)
Secondary school completed in Germany (n = 490)	2	105	21.4%
	1	170	34.7%
	0	215	43.9%
Secondary school completed abroad (n = 47)	2	20	42.6%
	1	11	23.4%
	0	16	34.0%
Math not attended as advanced course in secondary school (n = 202)	2	25	12.4%
	1	76	37.6%
	0	101	50.0%
Math attended as advanced course in secondary school (n = 290)	2	81	27.9%
	1	96	33.1%
	0	113	39.0%
No math preparatory course attended (n = 261)	2	53	20.3%
	1	90	34.5%
	0	118	45.2%
Math preparatory course attended (n = 274)	2	72	26.3%
	1	89	32.5%
	0	113	41.2%
University of applied sciences (n = 139)	2	22	15.8%
	1	52	37.4%
	0	65	46.8%
University (n = 402)	2	104	25.9%
	1	129	32.1%
	0	169	42.0%
Online Participation (n = 366)	2	91	24.9%
	1	124	33.9%
	0	151	41.3%
Pen-and-Paper Participation (n = 175)	2	35	20.0%
	1	57	32.6%
	0	83	47.7%
Attended Gymnasium (n = 395)	2	92	23.3%
	1	138	34.9%
	0	165	41.8%
Attended Other Secondary School (n = 139)	2	31	22.3%
	1	42	30.2%
	0	66	47.5%

Note. Due to missing values on demographics questions, frequencies within groups may not add up to the total number of responses.

Plots

All plots are generated from **Model A6**.

Item Information

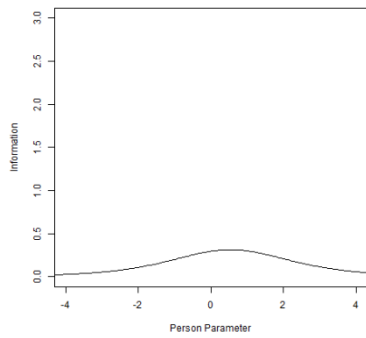

Expected Score

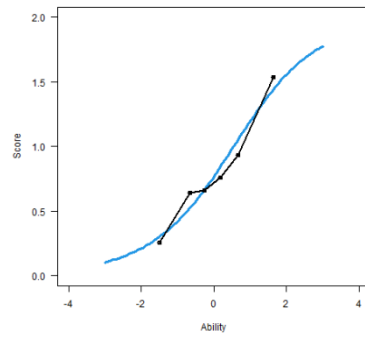

Probability

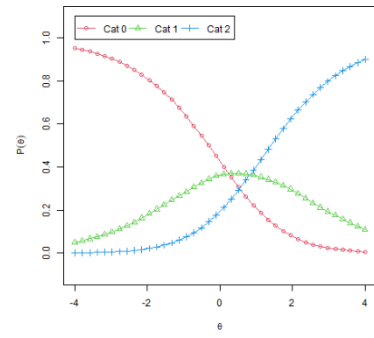

Note. The blue line represents expected performance, and the black line represents actual performance.

Note. Cat n = probability of receiving n points.

4.6.3. Angle Measurements (TR3)

Winkelmaße

Ergänzen Sie die fehlenden Einträge in der folgenden Umrechnungstabelle für Winkelmaße.

Beachten Sie: π wird als pi eingegeben. Nutzen Sie zum Ausdruck von Brüchen das Zeichen / (Division).

(Alt-)Grad	Radiant (Bogenmaß)
90°	<input type="text"/>
<input type="text"/> °	$\frac{\pi}{4}$
<input type="text"/> °	$-\frac{9}{6}\pi$

Math Problem ID

TR3

Correct Answers and Answer Frequencies

Blank	Correct Answer(s)	Number Correct Answers	Number Incorrect Answers
1	blinded	blinded	blinded
2	blinded	blinded	blinded
3	blinded	blinded	blinded

Note. Scoring (PCS4): Every correct response is worth one point (up to 3 points possible).

Item Characteristics

Discrimination					
Measurement Type		Model A6	Model B	Model C	Model D
Correlation to participant ability (θ)		0.74	0.72	0.72	0.72
Discrimination Parameter (α)		1.10	1.17	1.16	1.25
Discrimination (Detailed)					
Measurement Type	Points	Model A6	Model B	Model C	Model D
Difficulty for participant of average ability level	3	0.69	0.71	0.63	0.69
	2	-0.33	-0.29	-0.41	-0.29
	1	-0.47	-0.43	-0.64	-0.43
	0	NA	NA	NA	NA
Cumulative probability for participant of average ability level	3	24.4%	22.7%	26.3%	22.4%
	2	68.4%	67.4%	72.1%	68.3%
	1	75.2%	74.5%	81.9%	75.5%
	0	100%	100%	100%	100%
Frequencies					
Groups	Points	Frequencies		Percent (%)	
Complete sample for this math problem (n = 538)	3	160		29.7%	
	2	164		30.5%	
	1	27		5.0%	
	0	187		34.8%	
Female (n = 162)	3	34		21.0%	
	2	41		25.3%	
	1	14		8.6%	
	0	73		45.1%	
Male (n = 370)	3	125		33.8%	
	2	123		33.2%	
	1	13		3.5%	
	0	109		29.5%	
German as primary language at home (n = 404)	3	104		25.7%	
	2	131		32.4%	
	1	24		5.9%	
	0	145		35.9%	
Other language as primary language at home (n = 128)	3	55		43.0%	
	2	33		25.8%	
	1	3		2.3%	
	0	37		28.9%	
Secondary school completed in Germany (n = 487)	3	128		26.3%	
	2	155		31.8%	
	1	25		5.1%	
	0	179		36.8%	

Frequencies			
Groups	Points	Frequencies	Percent (%)
Secondary school completed abroad (n = 47)	3	31	66.0%
	2	9	19.1%
	1	2	4.3%
	0	5	10.6%
Math not attended as advanced course in secondary school (n = 200)	3	28	14.0%
	2	43	21.5%
	1	8	4.0%
	0	121	60.5%
Math attended as advanced course in secondary school (n = 289)	3	108	37.4%
	2	108	37.4%
	1	17	5.9%
	0	56	19.4%
No math preparatory course attended (n = 258)	3	61	23.6%
	2	70	27.1%
	1	9	3.5%
	0	118	45.7%
Math preparatory course attended (n = 274)	3	97	35.4%
	2	93	33.9%
	1	18	6.6%
	0	66	24.1%
University of applied sciences (n = 137)	3	21	15.3%
	2	33	24.1%
	1	11	8.0%
	0	72	52.6%
University (n = 401)	3	139	34.7%
	2	131	32.7%
	1	16	4.0%
	0	115	28.7%
Online Participation (n = 363)	3	104	28.7%
	2	122	33.6%
	1	16	4.4%
	0	121	33.3%
Pen-and-Paper Participation (n = 175)	3	56	32.0%
	2	42	24.0%
	1	11	6.3%
	0	66	37.7%
Attended Gymnasium (n = 394)	3	120	30.5%
	2	129	32.7%
	1	23	5.8%
	0	122	31.0%
Attended Other Secondary School (n = 137)	3	37	27.0%
	2	34	24.8%
	1	4	2.9%
	0	62	45.3%

Note. Due to missing values on demographics questions, frequencies within groups may not add up to the total number of responses.

Plots

All plots are generated from **Model A6**.

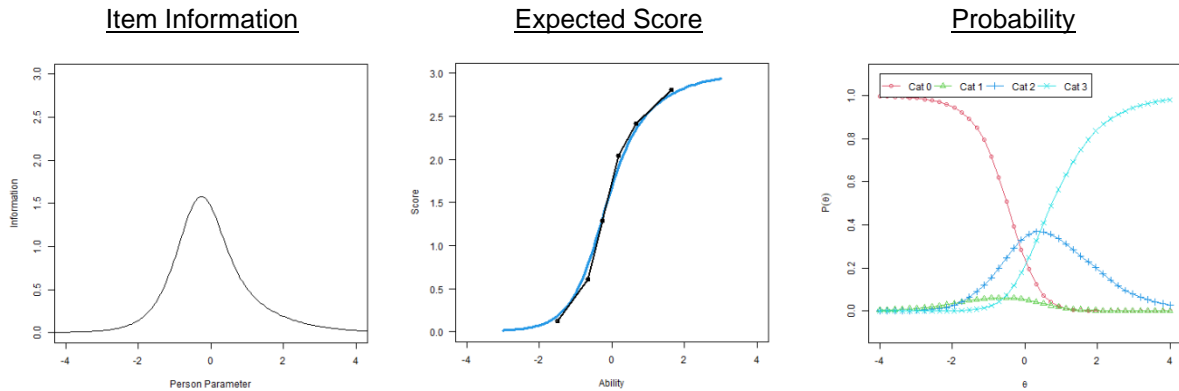

Note. The blue line represents expected performance, and the black line represents actual performance.

Note. Cat n = probability of receiving n points.

Differential Item Functioning (DIF)

This problem shows DIF based on attending math as an advanced or regular course in high school. The difficulty (β) and discrimination (α) parameters were significantly lower for those who attended math as an advanced course. This shows that the problem was significantly easier and less informative for those who took math as an advanced course in high school.

Expected Score (math attended as advanced course in high school)

Expected Score (Math not attended as advanced course in high school)

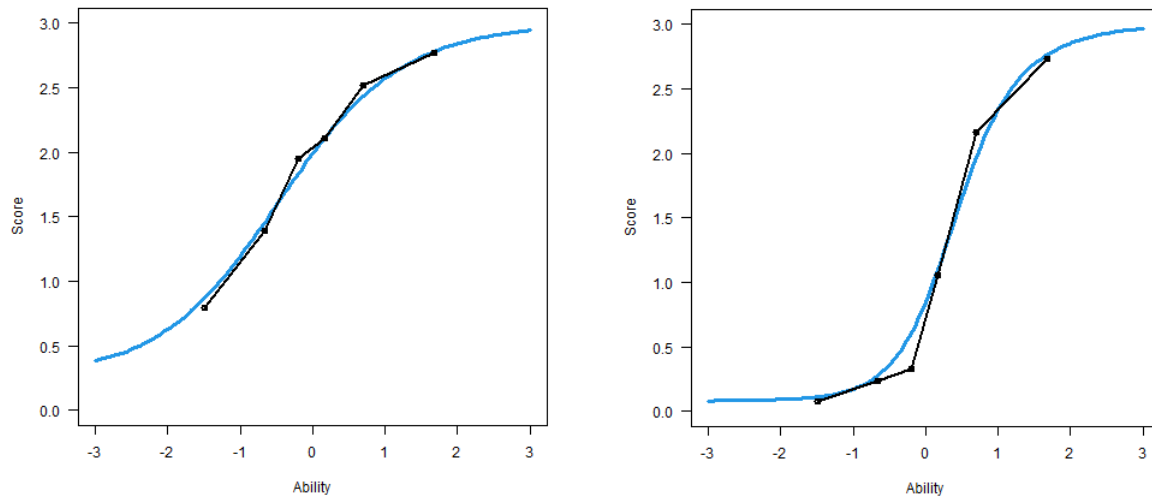

Note. The blue line represents expected performance, and the black line represents actual performance.

4.6.4. Sine Values (TR4)

Sinuswerte

Wählen Sie jeweils die richtige Antwort.

a)

$\sin(180^\circ) =$

$\frac{1}{\sqrt{2}}$	0	$\frac{1}{3}$	$\frac{\sqrt{3}}{2}$	-1	$\frac{1}{2}$	1
A	B	C	D	E	F	G

b)

$\sin(60^\circ) =$

$\frac{1}{\sqrt{2}}$	0	$\frac{1}{3}$	$\frac{\sqrt{3}}{2}$	-1	$\frac{1}{2}$	1
A	B	C	D	E	F	G

c)

$\sin(45^\circ) =$

$\frac{1}{\sqrt{2}}$	0	$\frac{1}{3}$	$\frac{\sqrt{3}}{2}$	-1	$\frac{1}{2}$	1
A	B	C	D	E	F	G

d)

$\sin(-90^\circ) =$

$\frac{1}{\sqrt{2}}$	0	$\frac{1}{3}$	$\frac{\sqrt{3}}{2}$	-1	$\frac{1}{2}$	1
A	B	C	D	E	F	G

Math Problem ID

TR4

Correct Answers and Answer Frequencies

Math Problem Part	Correct Answer	Number Correct Answers	Number Incorrect Answers ^a	Answer Frequencies						
				A	B	C	D	E	F	G
a)	blinded	blinded	blinded	blinded	blinded
b)	blinded	blinded	blinded	blinded	blinded	blinded
c)	blinded	blinded	blinded	blinded	blinded	blinded
d)	blinded	blinded	blinded	blinded	blinded	blinded

Note. Scoring (PCS4): Every correct response is worth one point (up to 4 points possible).

^a Includes cases, where the problem was seen but not answered.

Item Characteristics

Discrimination					
Measurement Type		Model A6	Model B	Model C	Model D
Correlation to participant ability (θ)		0.77	0.68	0.66	0.65
Discrimination Parameter (α)		1.04	0.79	0.74	0.92
Difficulty					
Measurement Type	Points	Model A6	Model B	Model C	Model D
Difficulty for participant of average ability level	4	1.13	1.27	1.22	1.19
	3	0.24	0.24	0.13	0.24
	2	-0.43	-0.49	-0.63	-0.45
	1	-0.87	-1.00	-1.28	-0.92
	0	NA	NA	NA	NA
Cumulative probability for participant of average ability level	4	11.9%	14.5%	17.3%	13.0%
	3	38.4%	40.2%	45.0%	39.2%
	2	71.9%	70.5%	74.0%	71.3%
	1	86.4%	84.3%	88.2%	85.5%
	0	100%	100%	100%	100%
Frequencies					
Groups	Points	Frequencies		Percent (%)	
Complete sample for this math problem (n = 542)	4	114		21.0%	
	3	117		21.6%	
	2	118		21.8%	
	1	66		12.2%	
	0	127		23.4%	
Female (n = 163)	4	27		22.8%	
	3	34		22.3%	
	2	37		21.8%	
	1	19		12.1%	
	0	46		21.0%	
Male (n = 372)	4	85		16.6%	
	3	83		20.9%	
	2	81		22.7%	
	1	45		11.7%	
	0	78		28.2%	
German as primary language at home (n = 416)	4	69		16.6%	
	3	90		21.6%	
	2	96		23.1%	
	1	58		13.9%	
	0	103		24.8%	

Frequencies			
Groups	Points	Frequencies	Percent (%)
Other language as primary language at home (n = 122)	4	44	36.1%
	3	27	22.1%
	2	21	17.2%
	1	7	5.7%
	0	23	18.9%
Secondary school completed in Germany (n = 499)	4	96	19.2%
	3	108	21.6%
	2	112	22.4%
	1	64	12.8%
	0	119	23.8%
Secondary school completed abroad (n = 41)	4	17	41.5%
	3	9	22.0%
	2	6	14.6%
	1	2	4.9%
	0	7	17.1%
Math not attended as advanced course in secondary school (n = 200)	4	24	12.0%
	3	31	15.5%
	2	32	16.0%
	1	28	14.0%
	0	85	42.5%
Math attended as advanced course in secondary school (n = 298)	4	75	25.2%
	3	77	25.8%
	2	74	24.8%
	1	35	11.7%
	0	37	12.4%
No math preparatory course attended (n = 262)	4	53	20.2%
	3	49	18.7%
	2	59	22.5%
	1	36	13.7%
	0	65	24.8%
Math preparatory course attended (n = 276)	4	59	21.4%
	3	68	24.6%
	2	59	21.4%
	1	30	10.9%
	0	60	21.7%
University of applied sciences (n = 140)	4	20	14.3%
	3	18	12.9%
	2	32	22.9%
	1	21	15.0%
	0	49	35.0%
University (n = 402)	4	94	23.4%
	3	99	24.6%
	2	86	21.4%
	1	45	11.2%
	0	78	19.4%

Frequencies			
Groups	Points	Frequencies	Percent (%)
Online Participation (n = 371)	4	87	23.5%
	3	84	22.6%
	2	74	19.9%
	1	42	11.3%
	0	84	22.6%
Pen-and-Paper Participation (n = 171)	4	27	15.8%
	3	33	19.3%
	2	44	25.7%
	1	24	14.0%
	0	43	25.1%
Attended Gymnasium (n = 403)	4	77	19.1%
	3	95	23.6%
	2	93	23.1%
	1	47	11.7%
	0	91	22.6%
Attended Other Secondary School (n = 134)	4	35	26.1%
	3	22	16.4%
	2	23	17.2%
	1	19	14.2%
	0	35	26.1%

Note. Due to missing values on demographics questions, frequencies within groups may not add up to the total number of responses.

Plots

All plots are generated from **Model A6**.

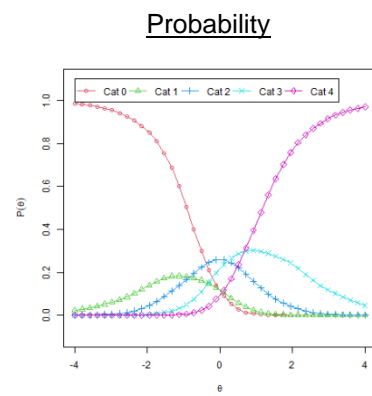
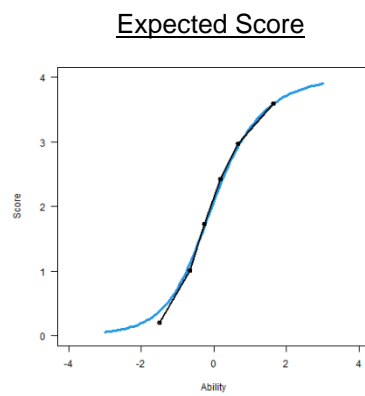
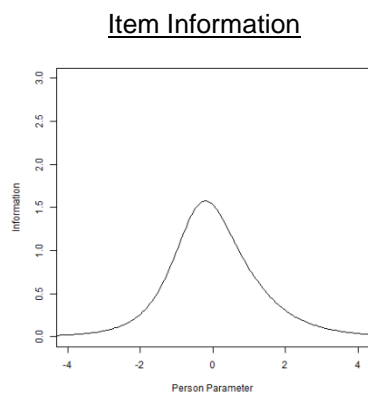

Note. The blue line represents expected performance, and the black line represents actual performance.

Note. Cat n = probability of receiving n points.

4.6.5. Trigonometric Pythagoras (TR5)

Trigonometrischer Pythagoras

Berechnen Sie für $x \in \mathbb{R}$.

Wählen Sie die richtige Antwort.

$$\sin^2(x) + \cos^2(x) = \dots$$

0	A
e	B
π	C
1	D

Math Problem ID

TR5

Correct Answers and Answer Frequencies

Correct Answer	Number Correct Answers	Number Incorrect Answers ^a	Answer Frequencies			
			A	B	C	D
blinded	blinded	blinded	blinded	blinded	blinded	blinded

Note. Scoring (PCS4): Every correct response is worth one point (up to 1 point possible).

^a Includes cases, where the problem was seen but not answered.

Item Characteristics

Discrimination					
Measurement Type		Model A6	Model B	Model C	Model D
Correlation to participant ability (θ)		0.56	0.48	0.47	0.49
Discrimination Parameter (α)		1.52	1.33	1.18	1.46
Difficulty					
Measurement Type	Points	Model A6	Model B	Model C	Model D
Difficulty for participant of average ability level	1	-0.71	-0.73	-0.93	-0.70
	0	NA	NA	NA	NA
Cumulative probability for participant of average ability level	1	74.5%	72.6%	74.9%	73.5%
	0	100%	100%	100%	100%

Frequencies			
Groups	Points	Frequencies	Percent (%)
Complete sample for this math problem (n = 547)	1	371	67.8%
	0	176	32.2%
Female (n = 164)	1	98	59.8%
	0	66	40.2%
Male (n = 377)	1	270	71.6%
	0	107	28.4%
German as primary language at home (n = 411)	1	261	63.5%
	0	150	36.5%
Other language as primary language at home (n = 130)	1	106	81.5%
	0	24	18.5%
Secondary school completed in Germany (n = 496)	1	324	65.3%
	0	172	34.7%
Secondary school completed abroad (n = 47)	1	45	95.7%
	0	2	4.3%
Math not attended as advanced course in secondary school (n = 206)	1	110	53.4%
	0	96	46.6%
Math attended as advanced course in secondary school (n = 292)	1	221	75.7%
	0	71	24.3%
No math preparatory course attended (n = 264)	1	172	65.2%
	0	92	34.8%
Math preparatory course attended (n = 277)	1	196	70.8%
	0	81	29.2%
University of applied sciences (n = 141)	1	80	56.7%
	0	61	43.3%
University (n = 406)	1	291	71.7%
	0	115	28.3%
Online Participation (n = 372)	1	258	69.4%
	0	114	30.6%
Pen-and-Paper Participation (n = 175)	1	113	64.6%
	0	62	35.4%
Attended Gymnasium (n = 398)	1	279	70.1%
	0	119	29.9%
Attended Other Secondary School (n = 142)	1	87	61.3%
	0	55	38.7%

Note. Due to missing values on demographics questions, frequencies within groups may not add up to the total number of responses.

Plots

All plots are generated from **Model A6**.

Item Information

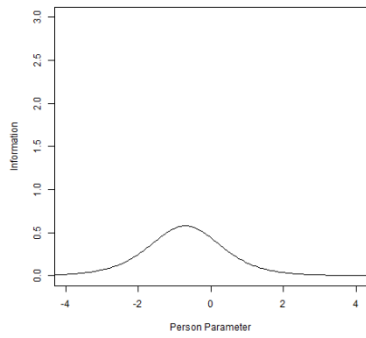

Expected Score

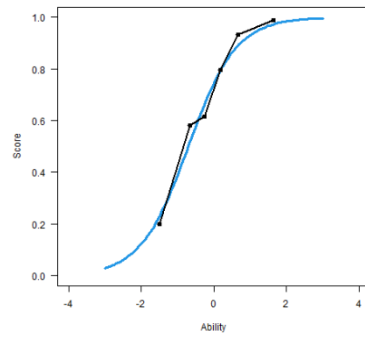

Note. The blue line represents expected performance, and the black line represents actual performance.

Probability

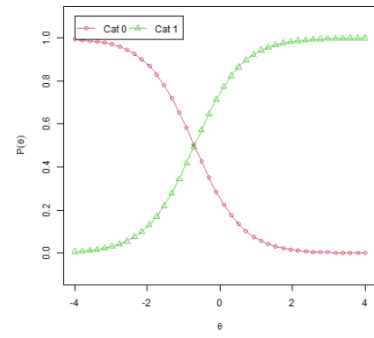

Note. Cat n = probability of receiving n points.

4.6.6. Interrelationships in Right Triangles (TR6)

Zusammenhänge im rechtwinkligen Dreieck

Gegeben sei die folgende Zeichnung:

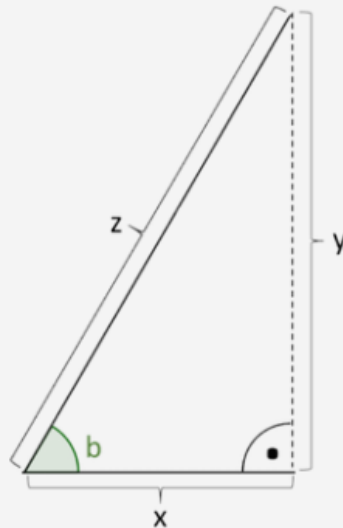

Geben Sie jeweils einen Term an, der die gesuchte Größe durch andere Größen aus der Zeichnung ausdrückt und dabei Sinus, Kosinus oder Tangens von b benutzt. Es gibt mehrere richtige Lösungen.

Ergänzen Sie die freien Felder.

Beachten Sie: Eingabe besonderer Funktionen: $\sin()$ (Sinus), $\cos()$ (Kosinus), $\tan()$ (Tangens).

Schreibweise:

Nutzen Sie folgende Zeichen: + (Addition), - (Subtraktion), * (Multiplikation), / (Division), ^ (Potenz), () Klammern.

$y =$

$x =$

Math Problem ID

TR6

Correct Answers and Answer Frequencies

Blank	Correct Answer(s)	Number Correct Answers	Number Incorrect Answers
1	blinded	blinded	blinded
2	blinded	blinded	blinded

Note. Scoring (PCS4): Every correct response is worth one point (up to 2 points possible).

Item Characteristics

Discrimination					
Measurement Type		Model A6	Model B	Model C	Model D
Correlation to participant ability (θ)		0.67	0.66	0.66	0.64
Discrimination Parameter (α)		1.14	1.15	1.16	1.20
Difficulty					
Measurement Type	Points	Model A6	Model B	Model C	Model D
Difficulty for participant of average ability level	2	0.54	0.53	0.50	0.53
	1	0.49	0.48	0.39	0.48
	0	NA	NA	NA	NA
Cumulative probability for participant of average ability level	2	22.9%	23.1%	25.1%	22.1%
	1	25.3%	25.6%	30.4%	24.5%
	0	100%	100%	100%	100%
Frequencies					
Groups	Points	Frequencies		Percent (%)	
Complete sample for this math problem (n = 538)	2	183		34.0%	
	1	10		1.9%	
	0	345		64.1%	
Female (n = 162)	2	48		29.6%	
	1	2		1.2%	
	0	112		69.1%	
Male (n = 369)	2	133		36.0%	
	1	8		2.2%	
	0	228		61.8%	
German as primary language at home (n = 412)	2	133		32.3%	
	1	7		1.7%	
	0	272		66.0%	
Other language as primary language at home (n = 122)	2	49		40.2%	
	1	3		2.5%	
	0	70		57.4%	
Secondary school completed in Germany (n = 495)	2	160		32.3%	
	1	9		1.8%	
	0	326		65.9%	
Secondary school completed abroad (n = 41)	2	22		53.7%	
	1	1		2.4%	
	0	18		43.9%	
Math not attended as advanced course in secondary school (n = 198)	2	28		14.1%	
	1	1		0.5%	
	0	169		85.4%	
Math attended as advanced course in secondary school (n = 296)	2	129		43.6%	
	1	7		2.4%	
	0	160		54.1%	

Frequencies			
Groups	Points	Frequencies	Percent (%)
No math preparatory course attended (n = 261)	2	74	28.4%
	1	5	1.9%
	0	182	69.7%
Math preparatory course attended (n = 273)	2	107	39.2%
	1	5	1.8%
	0	161	59.0%
University of applied sciences (n = 139)	2	19	13.7%
	1	2	1.4%
	0	118	84.9%
University (n = 399)	2	164	41.1%
	1	8	2.0%
	0	227	56.9%
Online Participation (n = 367)	2	126	34.3%
	1	6	1.6%
	0	235	64.0%
Pen-and-Paper Participation (n = 171)	2	57	33.3%
	1	4	2.3%
	0	110	64.3%
Attended Gymnasium (n = 401)	2	144	35.9%
	1	8	2.0%
	0	249	62.1%
Attended Other Secondary School (n = 132)	2	37	28.0%
	1	2	1.5%
	0	93	70.5%

Note. Due to missing values on demographics questions, frequencies within groups may not add up to the total number of responses.

Plots

All plots are generated from **Model A6**.

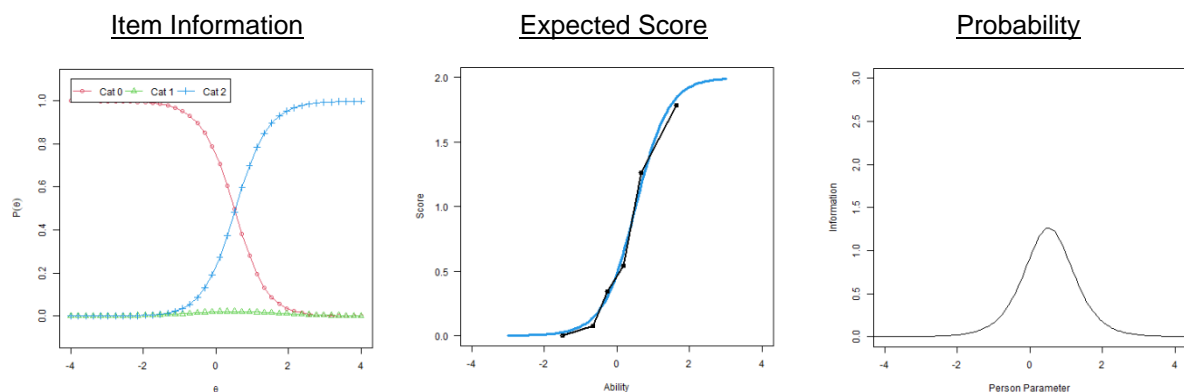

Note. The blue line represents expected performance, and the black line represents actual performance.

Note. Cat n = probability of receiving n points.

4.6.7. Side Lengths in Triangles (TR7)

Seitenlängen in Dreiecken

Gegeben sei ein **beliebiges** Dreieck mit Seitenlängen a , b und c sowie den Seiten gegenüberliegenden Winkeln α , β , γ .

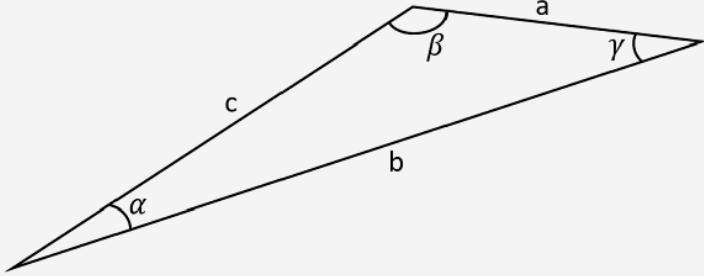

Wählen Sie die richtige Antwort.

$$c^2 = a^2 + b^2 - \dots$$

0
A

$a \cdot b \cdot \sin(\gamma)$
B

$2 \cdot b \cdot c \cdot \cos(\alpha)$
C

$2 \cdot a \cdot b \cdot \cos(\gamma)$
D

Math Problem ID

TR7

Correct Answers and Answer Frequencies

Correct Answer	Number Correct Answers	Number Incorrect Answers ^a	Answer Frequencies			
			A	B	C	D
blinded	blinded	blinded	blinded	blinded	blinded	blinded

Note. Scoring (PCS4): Every correct response is worth one point (up to 1 point possible).

^a Includes cases, where the problem was seen but not answered.

Item Characteristics

Discrimination					
Measurement Type		Model A6	Model B	Model C	Model D
Correlation to participant ability (θ)		0.60	0.55	0.54	0.53
Discrimination Parameter (α)		1.62	1.49	1.36	1.57
Difficulty					
Measurement Type	Points	Model A6	Model B	Model C	Model D
Difficulty for participant of average ability level	1	0.61	0.68	0.62	0.65
	0	NA	NA	NA	NA
Cumulative probability for participant of average ability level	1	26.9%	26.7%	30.3%	26.4%
	0	100%	100%	100%	100%

Frequencies			
Groups	Points	Frequencies	Percent (%)
Complete sample for this math problem (n = 537)	1	180	33.5%
	0	357	66.5%
Female (n = 162)	1	42	25.9%
	0	120	74.1%
Male (n = 369)	1	137	37.1%
	0	232	62.9%
German as primary language at home (n = 403)	1	108	26.8%
	0	295	73.2%
Other language as primary language at home (n = 128)	1	71	55.5%
	0	57	44.5%
Secondary school completed in Germany (n = 486)	1	145	29.8%
	0	341	70.2%
Secondary school completed abroad (n = 47)	1	34	72.3%
	0	13	27.7%
Math not attended as advanced course in secondary school (n = 199)	1	39	19.6%
	0	160	80.4%
Math attended as advanced course in secondary school (n = 289)	1	117	40.5%
	0	172	59.5%
No math preparatory course attended (n = 257)	1	83	32.3%
	0	174	67.7%
Math preparatory course attended (n = 274)	1	96	35.0%
	0	178	65.0%
University of applied sciences (n = 137)	1	30	21.9%
	0	107	78.1%
University (n = 400)	1	150	37.5%
	0	250	62.5%
Online Participation (n = 362)	1	131	36.2%
	0	231	63.8%
Pen-and-Paper Participation (n = 175)	1	49	28.0%
	0	126	72.0%
Attended Gymnasium (n = 393)	1	128	32.6%
	0	265	67.4%
Attended Other Secondary School (n = 137)	1	48	35.0%
	0	89	65.0%

Note. Due to missing values on demographics questions, frequencies within groups may not add up to the total number of responses.

Plots

All plots are generated from **Model A6**.

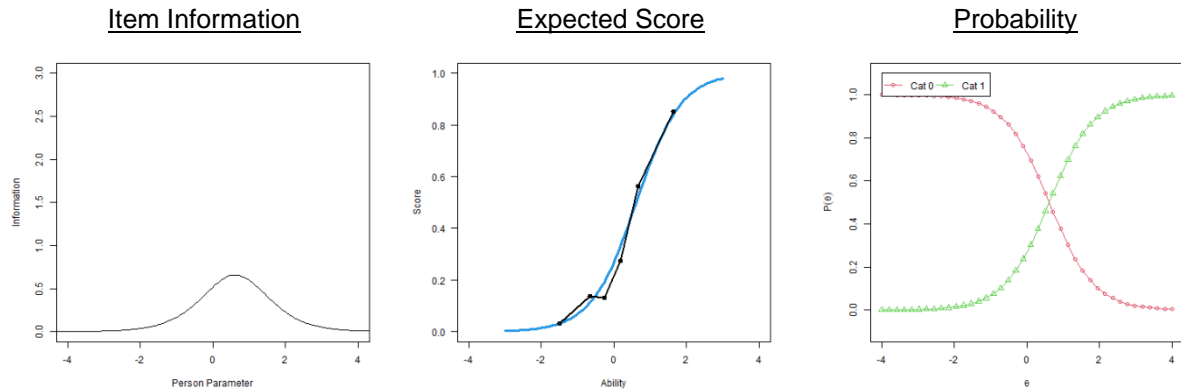

Note. The blue line represents expected performance, and the black line represents actual performance.

Note. Cat n = probability of receiving n points.

Differential Item Functioning (DIF)

This problem shows DIF across primary language. The difficulty (β) parameter was significantly lower for those who spoke a different language than German as their primary language at home. Meanwhile, the discrimination (α) parameter was significantly higher for those who spoke a different language than German at home. This shows that the problem was significantly harder and less informative for those who spoke German at home.

Expected Score (German as primary language)

Expected Score (other primary language)

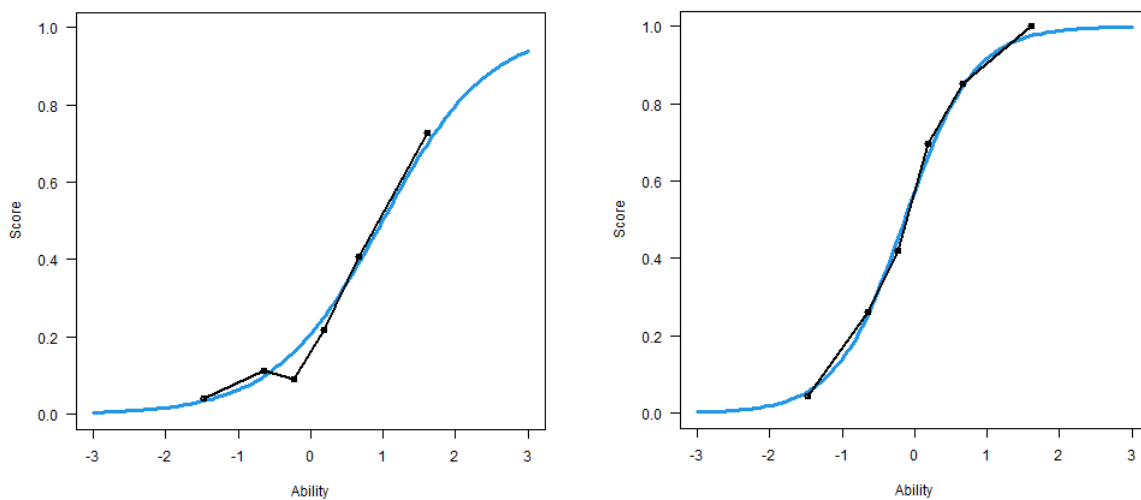

Note. The blue line represents expected performance, and the black line represents actual performance.

4.6.8. Sine and Cosine (TR8)

Sinus und Cosinus

In welchem Intervall liegt der Winkel α , für den gilt: $\sin(\alpha) < 0$ und $\cos(\alpha) > 0$?

Wählen Sie die richtige Antwort.

(0°, 90°)	A
(90°, 180°)	B
(180°, 270°)	C
(270°, 360°)	D

Math Problem ID

TR8

Correct Answers and Answer Frequencies

Correct Answer	Number Correct Answers	Number Incorrect Answers ^a	Answer Frequencies			
			A	B	C	D
blinded	blinded	blinded	blinded	blinded	blinded	blinded

Note. Scoring (PCS4): Every correct response is worth one point (up to 1 point possible).

^a Includes cases, where the problem was seen but not answered.

Item Characteristics

Discrimination					
Measurement Type		Model A6	Model B	Model C	Model D
Correlation to participant ability (θ)		0.68	0.64	0.63	0.61
Discrimination Parameter (α)		2.44	2.13	1.96	2.33
Difficulty					
Measurement Type	Points	Model A6	Model B	Model C	Model D
Difficulty for participant of average ability level	1	0.60	0.62	0.53	0.61
	0	NA	NA	NA	NA
Cumulative probability for participant of average ability level	1	18.9%	21.2%	26.1%	19.5%
	0	100%	100%	100%	100%

Frequencies			
Groups	Points	Frequencies	Percent (%)
Complete sample for this math problem (n = 542)	1	174	32.1%
	0	368	67.9%
Female (n = 163)	1	36	22.1%
	0	127	77.9%
Male (n = 372)	1	136	36.6%
	0	236	63.4%
German as primary language at home (n = 416)	1	121	29.1%
	0	295	70.9%
Other language as primary language at home (n = 122)	1	52	42.6%
	0	70	57.4%
Secondary school completed in Germany (n = 499)	1	148	29.7%
	0	351	70.3%
Secondary school completed abroad (n = 41)	1	25	61.0%
	0	16	39.0%
Math not attended as advanced course in secondary school (n = 200)	1	23	11.5%
	0	177	88.5%
Math attended as advanced course in secondary school (n = 298)	1	127	42.6%
	0	171	57.4%
No math preparatory course attended (n = 262)	1	78	29.8%
	0	184	70.2%
Math preparatory course attended (n = 276)	1	94	34.1%
	0	182	65.9%
University of applied sciences (n = 140)	1	23	16.4%
	0	117	83.6%
University (n = 402)	1	151	37.6%
	0	251	62.4%
Online Participation (n = 371)	1	123	33.2%
	0	248	66.8%
Pen-and-Paper Participation (n = 171)	1	51	29.8%
	0	120	70.2%
Attended Gymnasium (n = 403)	1	132	32.8%
	0	271	67.2%
Attended Other Secondary School (n = 134)	1	40	29.9%
	0	94	70.1%

Note. Due to missing values on demographics questions, frequencies within groups may not add up to the total number of responses.

Plots

All plots are generated from **Model A6**.

Item Information

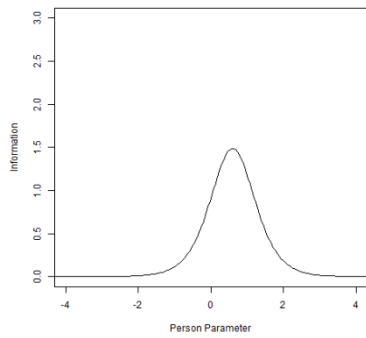

Expected Score

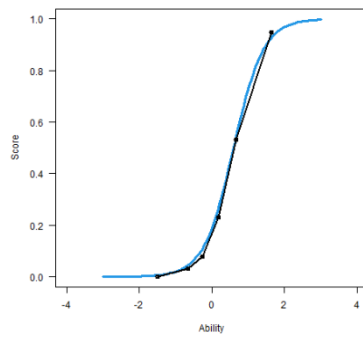

Note. The blue line represents expected performance, and the black line represents actual performance.

Probability

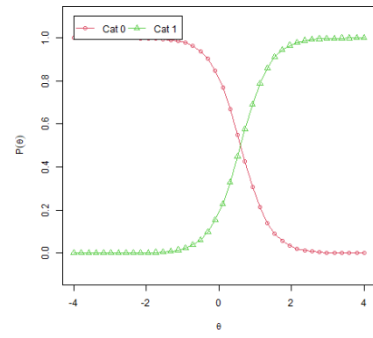

Note. Cat n = probability of receiving n points.

4.6.9. Reading on the Unit Circle (TR9)

Ablezen am Einheitskreis

Gegeben ist die folgende Figur am Einheitskreis. Welche der benannten Längen ist $\sin(\alpha)$?

Wählen Sie die richtige Antwort.

A a **B** b **C** c **D** d

Math Problem ID

TR9

Correct Answers and Answer Frequencies

Correct Answer	Number Correct Answers	Number Incorrect Answers ^a	Answer Frequencies			
			A	B	C	D
blinded	blinded	blinded	blinded	blinded	blinded	blinded

Note. Scoring (PCS4): Every correct response is worth one point (up to 1 point possible).

^a Includes cases, where the problem was seen but not answered.

Item Characteristics

Discrimination					
Measurement Type		Model A6	Model B	Model C	Model D
Correlation to participant ability (θ)		0.49	0.45	0.44	0.44
Discrimination Parameter (α)		1.14	1.06	0.99	1.13
Difficulty					
Measurement Type	Points	Model A6	Model B	Model C	Model D
Difficulty for participant of average ability level	1	0.07	0.05	-0.06	0.06
	0	NA	NA	NA	NA
Cumulative probability for participant of average ability level	1	48.1%	48.6%	51.5%	48.2%
	0	100%	100%	100%	100%
Frequencies					
Groups	Points	Frequencies		Percent (%)	
Complete sample for this math problem (n = 524)	1	261		49.8%	
	0	263		50.2%	
Female (n = 159)	1	74		46.5%	
	0	85		53.5%	
Male (n = 358)	1	185		51.7%	
	0	173		48.3%	
German as primary language at home (n = 401)	1	195		48.6%	
	0	206		51.4%	
Other language as primary language at home (n = 119)	1	64		53.8%	
	0	55		46.2%	
Secondary school completed in Germany (n = 481)	1	230		47.8%	
	0	251		52.2%	
Secondary school completed abroad (n = 41)	1	30		73.2%	
	0	11		26.8%	
Math not attended as advanced course in secondary school (n = 185)	1	75		40.5%	
	0	110		59.5%	
Math attended as advanced course in secondary school (n = 295)	1	155		52.5%	
	0	140		47.5%	
No math preparatory course attended (n = 258)	1	130		50.4%	
	0	128		49.6%	
Math preparatory course attended (n = 263)	1	129		49.0%	
	0	134		51.0%	
University of applied sciences (n = 121)	1	50		41.3%	
	0	71		58.7%	
University (n = 403)	1	211		52.4%	
	0	192		47.6%	
Online Participation (n = 353)	1	178		50.4%	
	0	175		49.6%	
Pen-and-Paper Participation (n = 171)	1	83		48.5%	
	0	88		51.5%	

Frequencies			
Groups	Points	Frequencies	Percent (%)
Attended Gymnasium (n = 393)	1	196	49.9%
	0	197	50.1%
Attended Other Secondary School (n = 126)	1	63	50.0%
	0	63	50.0%

Note. Due to missing values on demographics questions, frequencies within groups may not add up to the total number of responses.

Plots

All plots are generated from **Model A6**.

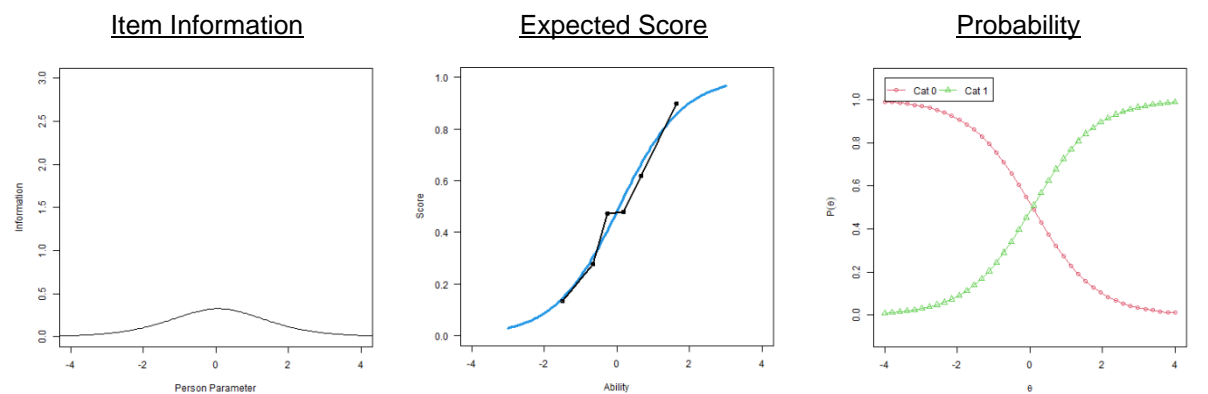

Note. The blue line represents expected performance, and the black line represents actual performance.

Note. Cat n = probability of receiving n points.

4.6.10. Symmetry of Sine and Cosine (TR10)

Symmetrie von Sinus und Kosinus

Die Graphen von $\sin(x)$ (Sinus) und $\cos(x)$ (Kosinus) sind jeweils symmetrisch. Welche Symmetrie gilt?

Wählen Sie die richtige Antwort.

$\sin(x)$ ist achsensymmetrisch zur y-Achse, $\cos(x)$ ist punktsymmetrisch zum Punkt $P(0,0)$. A

$\sin(x)$ ist punktsymmetrisch zum Punkt $P(0,0)$, $\cos(x)$ ist achsensymmetrisch zur y-Achse. B

$\sin(x)$ und $\cos(x)$ sind punktsymmetrisch zum Punkt $P(0,0)$. C

$\sin(x)$ und $\cos(x)$ sind achsensymmetrisch zur y-Achse. D

Math Problem ID

TR10

Correct Answers and Answer Frequencies

Correct Answer	Number Correct Answers	Number Incorrect Answers ^a	Answer Frequencies			
			A	B	C	D
blinded	blinded	blinded	blinded	blinded	blinded	blinded

Note. Scoring (PCS4): Every correct response is worth one point (up to 1 point possible).

^a Includes cases, where the problem was seen but not answered.

Item Characteristics

Discrimination					
Measurement Type		Model A6	Model B	Model C	Model D
Correlation to participant ability (θ)		0.51	0.48	0.47	0.47
Discrimination Parameter (α)		1.19	1.16	1.05	1.20
Difficulty					
Measurement Type	Points	Model A6	Model B	Model C	Model D
Difficulty for participant of average ability level	1	0.28	0.32	0.24	0.31
	0	NA	NA	NA	NA
Cumulative probability for participant of average ability level	1	41.7%	40.7%	43.9%	40.7%
	0	100%	100%	100%	100%

Frequencies			
Groups	Points	Frequencies	Percent (%)
Complete sample for this math problem (n = 519)	1	228	43.9%
	0	291	56.1%
Female (n = 157)	1	54	34.4%
	0	103	65.6%
Male (n = 356)	1	173	48.6%
	0	183	51.4%
German as primary language at home (n = 388)	1	166	42.8%
	0	222	57.2%
Other language as primary language at home (n = 125)	1	61	48.8%
	0	64	51.2%
Secondary school completed in Germany (n = 468)	1	202	43.2%
	0	266	56.8%
Secondary school completed abroad (n = 47)	1	25	53.2%
	0	22	46.8%
Math not attended as advanced course in secondary school (n = 185)	1	56	30.3%
	0	129	69.7%
Math attended as advanced course in secondary school (n = 285)	1	146	51.2%
	0	139	48.8%
No math preparatory course attended (n = 251)	1	96	38.2%
	0	155	61.8%
Math preparatory course attended (n = 263)	1	131	49.8%
	0	132	50.2%
University of applied sciences (n = 120)	1	36	30.0%
	0	84	70.0%
University (n = 399)	1	192	48.1%
	0	207	51.9%
Online Participation (n = 345)	1	151	43.8%
	0	194	56.2%
Pen-and-Paper Participation (n = 174)	1	77	44.3%
	0	97	55.7%
Attended Gymnasium (n = 384)	1	170	44.3%
	0	214	55.7%
Attended Other Secondary School (n = 128)	1	54	42.2%
	0	74	57.8%

Note. Due to missing values on demographics questions, frequencies within groups may not add up to the total number of responses.

Plots

All plots are generated from **Model A6**.

Item Information

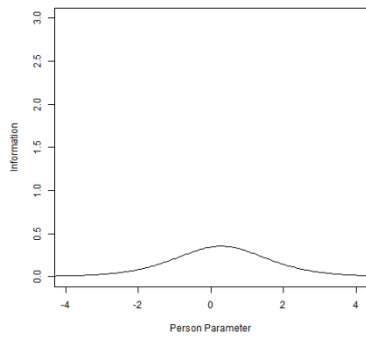

Expected Score

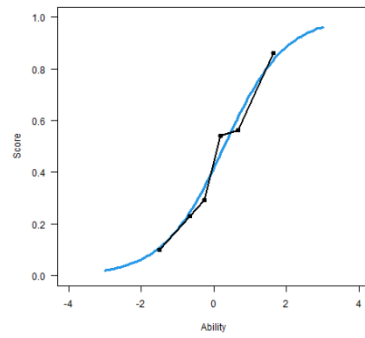

Probability

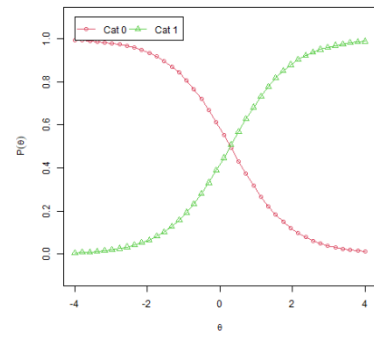

Note. The blue line represents expected performance, and the black line represents actual performance.

Note. Cat n = probability of receiving n points.

4.7. Higher Functions (Höhere Funktionen; HF)

Q₃ Statistics for Higher Functions

	HF1	HF2	HF3	HF4	HF5	HF6	HF7	HF8	HF9	HF10
HF1	-									
HF2	.045	-								
HF3	-.037	-.126	-							
HF4	.139	.082	-.092	-						
HF5	.036	.135	-.188	-.001	-					
HF6	-.015	-.108	-.131	-.139	.013	-				
HF7	.012	.238	-.112	.203	.192	-.169	-			
HF8	-.122	-.182	-.198	-.100	-.109	.022	-.060	-		
HF9	-.167	-.073	-.123	-.120	-.051	.005	-.043	-.028	-	
HF10	.156	.114	-.052	.284	.061	-.176	.381	-.169	-.122	-

Note. Q₃ statistics above the critical absolute value of 0.20 are bolded. For details see **Section 3.1**.

4.7.1. Graphs of Known Functions (HF1)

Graphen bekannter Funktionen

Wählen Sie den Funktionsterm der folgenden Graphen aus.

Wählen Sie jeweils die richtige Antwort.

a)

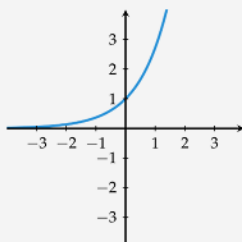

- A e^x
- B \sqrt{x}
- C $\sin(x)$
- D $\cos(x)$
- E $\frac{1}{x}$

b)

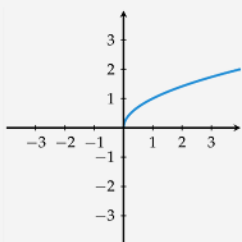

- A e^x
- B \sqrt{x}
- C $\sin(x)$
- D $\cos(x)$
- E $\frac{1}{x}$

c)

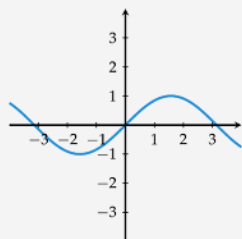

- A e^x
- B \sqrt{x}
- C $\sin(x)$
- D $\cos(x)$
- E $\frac{1}{x}$

d)

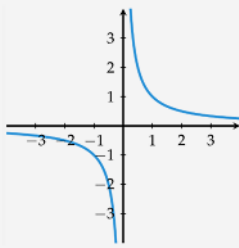

A e^x
 B \sqrt{x}
 C $\sin(x)$
 D $\cos(x)$
 E $\frac{1}{x}$

Math Problem ID

HF1

Correct Answers and Answer Frequencies

Math Problem Part	Correct Answer	Number Correct Answers	Number Incorrect Answers ^a	Answer Frequencies				
				A	B	C	D	E
a)	blinded	blinded	blinded	blinded	blinded	blinded	blinded	blinded
b)	blinded	blinded	blinded	blinded	blinded	blinded	blinded	blinded
c)	blinded	blinded	blinded	blinded	blinded	blinded	blinded	blinded
d)	blinded	blinded	blinded	blinded	blinded	blinded	blinded	blinded

Note. Scoring (PCS4): Every correct response is worth one point (up to 4 points possible).

^a Includes cases, where the problem was seen but not answered.

Item Characteristics

Discrimination					
Measurement Type		Model A7	Model B	Model C	Model D
Correlation to participant ability (θ)		0.64	0.59	0.61	0.61
Discrimination Parameter (α)		1.41	1.10	1.28	1.34
Difficulty					
Measurement Type	Points	Model A7	Model B	Model C	Model D
Difficulty for participant of average ability level	4	-0.73	-0.71	-0.89	-0.68
	3	-0.99	-0.97	-1.25	-0.93
	2	-1.59	-1.58	-1.90	-1.52
	1	-2.12	-2.15	-2.73	-2.04
	0	NA	NA	NA	NA
Cumulative probability for participant of average ability level	4	83.6%	79.3%	84.2%	81.5%
	3	94.1%	90.3%	95.8%	92.6%
	2	99.5%	98.7%	99.7%	99.3%
	1	100%	99.8%	100%	99.9%
	0	100%	100%	100%	100%
Frequencies					
Groups	Points	Frequencies	Percent (%)		
Complete sample for this math problem (n = 552)	4	388	70.3%		
	3	51	9.2%		
	2	67	12.1%		
	1	26	4.7%		
	0	20	3.6%		
Female (n = 178)	4	115	64.6%		
	3	16	9.0%		
	2	27	15.2%		
	1	15	8.4%		
	0	5	2.8%		
Male (n = 370)	4	270	73.0%		
	3	34	9.2%		
	2	40	10.8%		
	1	11	3.0%		
	0	15	4.1%		
German as primary language at home (n = 420)	4	293	69.8%		
	3	36	8.6%		
	2	52	12.4%		
	1	24	5.7%		
	0	15	3.6%		

Frequencies			
Groups	Points	Frequencies	Percent (%)
Other language as primary language at home (n = 131)	4	95	72.5%
	3	15	11.5%
	2	14	10.7%
	1	2	1.5%
	0	5	3.8%
Secondary school completed in Germany (n = 489)	4	339	69.3%
	3	44	9.0%
	2	61	12.5%
	1	26	5.3%
	0	19	3.9%
Secondary school completed abroad (n = 62)	4	48	77.4%
	3	7	11.3%
	2	6	9.7%
	1	0	0.0%
	0	1	1.6%
Math not attended as advanced course in secondary school (n = 195)	4	90	46.2%
	3	27	13.8%
	2	42	21.5%
	1	23	11.8%
	0	13	6.7%
Math attended as advanced course in secondary school (n = 316)	4	272	86.1%
	3	18	5.7%
	2	21	6.6%
	1	3	0.9%
	0	2	0.6%
No math preparatory course attended (n = 245)	4	161	65.7%
	3	25	10.2%
	2	35	14.3%
	1	12	4.9%
	0	12	4.9%
Math preparatory course attended (n = 303)	4	224	73.9%
	3	25	8.3%
	2	32	10.6%
	1	14	4.6%
	0	8	2.6%
University of applied sciences (n = 144)	4	73	50.7%
	3	19	13.2%
	2	23	16.0%
	1	14	9.7%
	0	15	10.4%
University (n = 408)	4	315	77.2%
	3	32	7.8%
	2	44	10.8%
	1	12	2.9%
	0	5	1.2%

Frequencies			
Groups	Points	Frequencies	Percent (%)
Online Participation (n = 373)	4	263	70.5%
	3	38	10.2%
	2	37	9.9%
	1	18	4.8%
	0	17	4.6%
Pen-and-Paper Participation (n = 179)	4	125	69.8%
	3	13	7.3%
	2	30	16.8%
	1	8	4.5%
	0	3	1.7%
Attended Gymnasium (n = 409)	4	305	74.6%
	3	38	9.3%
	2	43	10.5%
	1	15	3.7%
	0	8	2.0%
Attended Other Secondary School (n = 130)	4	74	56.9%
	3	12	9.2%
	2	22	16.9%
	1	10	7.7%
	0	12	9.2%

Note. Due to missing values on demographics questions, frequencies within groups may not add up to the total number of responses.

Plots

All plots are generated from **Model A7**.

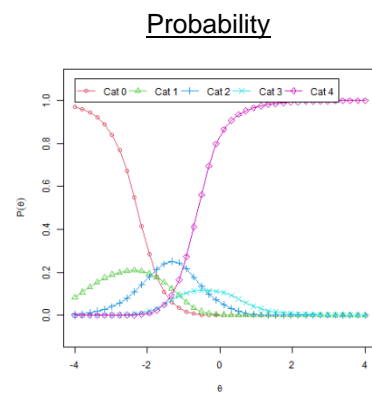
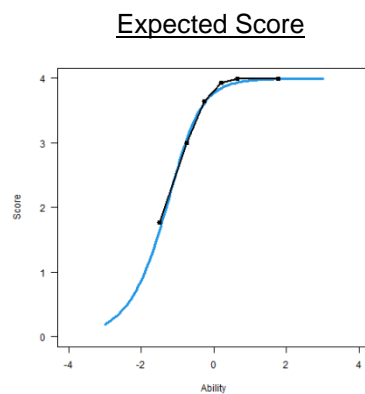
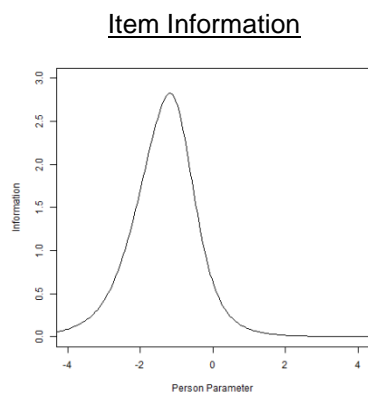

Note. The blue line represents expected performance, and the black line represents actual performance.

Note. Cat n = probability of receiving n points.

4.7.2. Transformation of Graphs (HF2)

Transformation von Graphen

Im Folgenden sind Transformationen von Funktionsgraphen angegeben. Der linke Graph stellt jeweils die Funktion $f(x)$ dar. Welcher Term beschreibt dann jeweils den rechten Graphen?

Wählen Sie jeweils die richtige Antwort.

a)

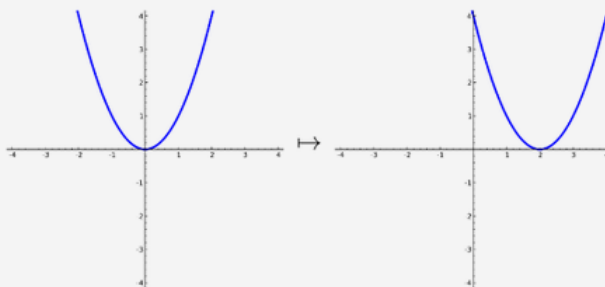

A $f(x^2)$

D $f(x + 2)$

F $f(\frac{x}{2})$

B $f(x - 2)$

E $f(\frac{1}{x})$

G $f(x^3)$

C $f(2 \cdot x)$

b)

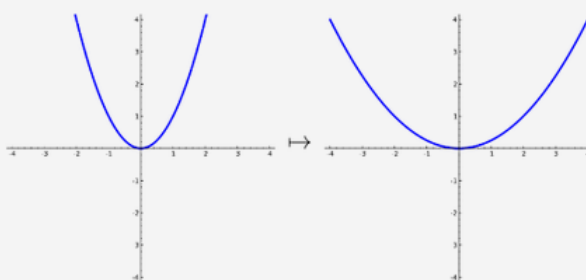

A $f(x^2)$

D $f(x + 2)$

F $f(\frac{x}{2})$

B $f(x - 2)$

E $f(\frac{1}{x})$

G $f(x^3)$

C $f(2 \cdot x)$

c)

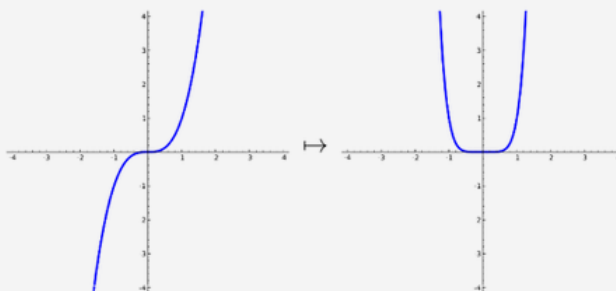

A $f(x^2)$

D $f(x + 2)$

F $f(\frac{x}{2})$

B $f(x - 2)$

E $f(\frac{1}{x})$

G $f(x^3)$

C $f(2 \cdot x)$

Math Problem ID

HF2

Correct Answers and Answer Frequencies

Math Problem Part	Correct Answer	Number Correct Answers	Number Incorrect Answers ^a	Answer Frequencies							
				A	B	C	D	E	F	G	
a)	blinded	blinded	blinded	blinded	blinded				
b)	blinded	blinded	blinded	blinded	blinded				
c)	blinded	blinded	blinded	blinded	blinded				

Note. Scoring (PCS4): Every correct response is worth one point (up to 3 points possible).

^a Includes cases, where the problem was seen but not answered.

Item Characteristics

Discrimination					
Measurement Type		Model A7	Model B	Model C	Model D
Correlation to participant ability (θ)		0.76	0.69	0.70	0.70
Discrimination Parameter (α)		1.51	1.22	1.17	1.44
Difficulty					
Measurement Type	Points	Model A7	Model B	Model C	Model D
Difficulty for participant of average ability level	3	0.72	0.76	0.75	0.74
	2	-0.15	-0.15	-0.28	-0.13
	1	-0.98	-1.02	-1.28	-0.96
	0	NA	NA	NA	NA
Cumulative probability for participant of average ability level	3	17.6%	20.1%	22.4%	17.9%
	2	58.4%	57.2%	62.6%	57.0%
	1	90.4%	87.8%	91.3%	89.1%
	0	100%	100%	100%	100%
Frequencies					
Groups	Points	Frequencies	Percent (%)		
Complete sample for this math problem (n = 539)	3	152	28.2%		
	2	147	27.3%		
	1	129	23.9%		
	0	111	20.6%		
Female (n = 166)	3	27	16.3%		
	2	45	27.1%		
	1	43	25.9%		
	0	51	30.7%		
Male (n = 368)	3	121	32.9%		
	2	101	27.4%		
	1	86	23.4%		
	0	60	16.3%		
German as primary language at home (n = 406)	3	116	28.6%		
	2	108	26.6%		
	1	100	24.6%		
	0	82	20.2%		

Frequencies			
Groups	Points	Frequencies	Percent (%)
Other language as primary language at home (n = 132)	3	36	27.3%
	2	38	28.8%
	1	29	22.0%
	0	29	22.0%
Secondary school completed in Germany (n = 470)	3	130	27.7%
	2	125	26.6%
	1	118	25.1%
	0	97	20.6%
Secondary school completed abroad (n = 68)	3	22	32.4%
	2	21	30.9%
	1	11	16.2%
	0	14	20.6%
Math not attended as advanced course in secondary school (n = 185)	3	19	10.3%
	2	43	23.2%
	1	49	26.5%
	0	74	40.0%
Math attended as advanced course in secondary school (n = 306)	3	120	39.2%
	2	90	29.4%
	1	68	22.2%
	0	28	9.2%
No math preparatory course attended (n = 245)	3	48	19.6%
	2	60	24.5%
	1	71	29.0%
	0	66	26.9%
Math preparatory course attended (n = 290)	3	103	35.5%
	2	85	29.3%
	1	57	19.7%
	0	45	15.5%
University of applied sciences (n = 143)	3	20	14.0%
	2	32	22.4%
	1	38	26.6%
	0	53	37.1%
University (n = 396)	3	132	33.3%
	2	115	29.0%
	1	91	23.0%
	0	58	14.6%
Online Participation (n = 363)	3	95	26.2%
	2	94	25.9%
	1	91	25.1%
	0	83	22.9%
Pen-and-Paper Participation (n = 176)	3	57	32.4%
	2	53	30.1%
	1	38	21.6%
	0	28	15.9%

Frequencies			
Groups	Points	Frequencies	Percent (%)
Attended Gymnasium (n = 389)	3	125	32.1%
	2	114	29.3%
	1	95	24.4%
	0	54	14.1%
Attended Other Secondary School (n = 137)	3	23	16.8%
	2	32	23.4%
	1	31	22.6%
	0	51	37.2%

Note. Due to missing values on demographics questions, frequencies within groups may not add up to the total number of responses.

Plots

All plots are generated from **Model A7**.

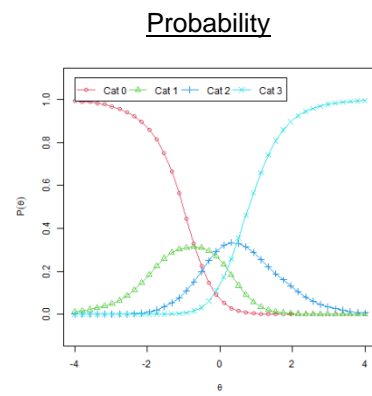
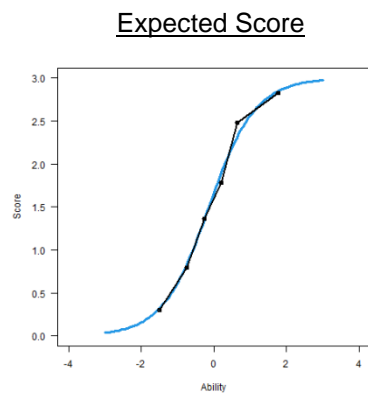
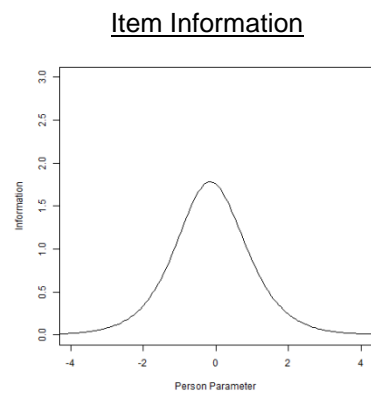

Note. The blue line represents expected performance, and the black line represents actual performance.

Note. Cat n = probability of receiving n points.

4.7.3. Null states (HF3)

Nullstellen

Bestimmen Sie die Nullstellen folgender Funktionen. Achten Sie darauf, ob die gefundenen Stellen auch tatsächlich im Definitionsbereich der jeweiligen Funktion liegen.

Ergänzen Sie die freien Felder.

Beachten Sie: Geben Sie die Nullstellen durch Semikolon getrennt ein. Sollte eine Funktion keine Nullstelle haben, geben Sie den Buchstaben *k* ein.

Funktion	Nullstelle(n)
$x^2 - 2x - 15$	<input style="width: 80%; height: 20px;" type="text"/>
$x^3 - x$	<input style="width: 80%; height: 20px;" type="text"/>
$\ln(x - 1) \cdot \sqrt{x + 1}$	<input style="width: 80%; height: 20px;" type="text"/>

Math Problem ID

HF3

Correct Answers and Answer Frequencies

Blank	Correct Answer(s)	Number Correct Answers	Number Incorrect Answers
1	blinded	blinded	blinded
2	blinded	blinded	blinded
3	blinded	blinded	blinded

Note. Scoring (PCS4): Every correct response is worth one point, but if any correct answers were given in coordinate form instead of entering the null states (e.g., "2,0" for Part c), the total number of points earned was reduced by 1 (up to 3 points possible).

Item Characteristics

Discrimination					
Measurement Type		Model A7	Model B	Model C	Model D
Correlation to participant ability (θ)		0.66	0.66	0.66	0.66
Discrimination Parameter (α)		1.03	1.14	1.01	1.15
Difficulty					
Measurement Type	Points	Model A7	Model B	Model C	Model D
Difficulty for participant of average ability level	3	2.26	2.16	2.40	2.15
	2	0.49	0.51	0.47	0.50
	1	-0.52	-0.44	-0.64	-0.44
	0	NA	NA	NA	NA
Cumulative probability for participant of average ability level	3	3.2%	2.6%	3.0%	2.5%
	2	31.7%	29.4%	33.0%	29.5%
	1	68.3%	66.8%	71.2%	67.2%
	0	100%	100%	100%	100%
Frequencies					
Groups	Points	Frequencies		Percent (%)	
Complete sample for this math problem (n = 549)	3	44		8.0%	
	2	156		28.4%	
	1	154		28.1%	
	0	195		35.5%	
Female (n = 177)	3	10		5.6%	
	2	50		28.2%	
	1	50		28.2%	
	0	67		37.9%	
Male (n = 368)	3	33		9.0%	
	2	106		28.8%	
	1	102		27.7%	
	0	127		34.5%	
German as primary language at home (n = 419)	3	30		7.2%	
	2	114		27.2%	
	1	121		28.9%	
	0	154		36.8%	
Other language as primary language at home (n = 129)	3	14		10.9%	
	2	42		32.6%	
	1	32		24.8%	
	0	41		31.8%	
Secondary school completed in Germany (n = 487)	3	35		7.2%	
	2	135		27.7%	
	1	136		27.9%	
	0	181		37.2%	

Frequencies			
Groups	Points	Frequencies	Percent (%)
Secondary school completed abroad (n = 61)	3	9	14.8%
	2	21	34.4%
	1	17	27.9%
	0	14	23.0%
Math not attended as advanced course in secondary school (n = 194)	3	4	2.1%
	2	23	11.9%
	1	61	31.4%
	0	106	54.6%
Math attended as advanced course in secondary school (n = 314)	3	40	12.7%
	2	119	37.9%
	1	81	25.8%
	0	74	23.6%
No math preparatory course attended (n = 244)	3	14	5.7%
	2	62	25.4%
	1	66	27.0%
	0	102	41.8%
Math preparatory course attended (n = 301)	3	30	10.0%
	2	91	30.2%
	1	87	28.9%
	0	93	30.9%
University of applied sciences (n = 143)	3	1	0.7%
	2	25	17.5%
	1	33	23.1%
	0	84	58.7%
University (n = 406)	3	43	10.6%
	2	131	32.3%
	1	121	29.8%
	0	111	27.3%
Online Participation (n = 371)	3	34	9.2%
	2	102	27.5%
	1	104	28.0%
	0	131	35.3%
Pen-and-Paper Participation (n = 178)	3	10	5.6%
	2	54	30.3%
	1	50	28.1%
	0	64	36.0%
Attended Gymnasium (n = 407)	3	37	9.1%
	2	130	31.9%
	1	118	29.0%
	0	122	30.0%
Attended Other Secondary School (n = 129)	3	6	4.7%
	2	23	17.8%
	1	30	23.3%
	0	70	54.3%

Note. Due to missing values on demographics questions, frequencies within groups may not add up to the total number of responses.

Plots

All plots are generated from **Model A7**.

Item Information

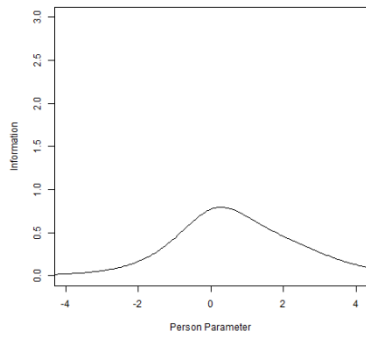

Expected Score

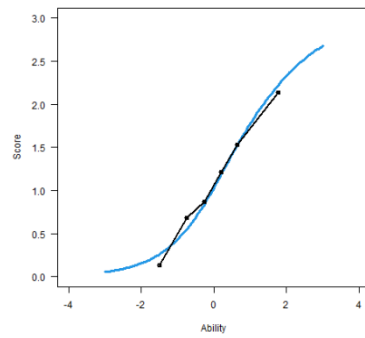

Note. The blue line represents expected performance, and the black line represents actual performance.

Probability

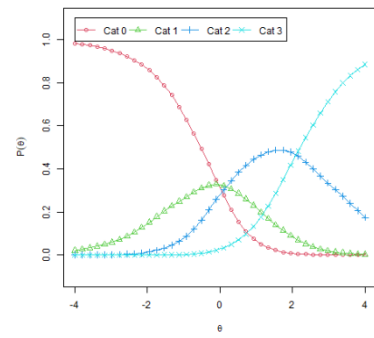

Note. Cat n = probability of receiving n points.

4.7.4. Important Limits (HF4)

Wichtige Grenzwerte

Geben Sie die gesuchten Grenzwerte an.

Wählen Sie jeweils die richtige Antwort.

a)

$$\lim_{x \rightarrow 0} \ln(x) =$$

A $-\infty$ B -1 C 0 D 1 E ∞

b)

$$\lim_{x \rightarrow \infty} e^{-x} =$$

A $-\infty$ B -1 C 0 D 1 E ∞

c)

$$\lim_{x \rightarrow -\infty} x^4 =$$

A $-\infty$ B -1 C 0 D 1 E ∞

Math Problem ID

HF4

Correct Answers and Answer Frequencies

Math Problem Part	Correct Answer	Number Correct Answers	Number Incorrect Answers ^a	Answer Frequencies				
				A	B	C	D	E
a)	blinded	blinded	blinded	blinded	blinded	blinded	blinded	blinded
b)	blinded	blinded	blinded	blinded	blinded	blinded	blinded	blinded
c)	blinded	blinded	blinded	blinded	blinded	blinded	blinded	blinded

Note. Scoring (PCS4): Every correct response is worth one point (up to 3 points possible).

^a Includes cases, where the problem was seen but not answered.

Item Characteristics

Discrimination					
Measurement Type		Model A7	Model B	Model C	Model D
Correlation to participant ability (θ)		0.77	0.74	0.75	0.75
Discrimination Parameter (α)		1.58	1.54	1.40	1.74
Difficulty					
Measurement Type	Points	Model A7	Model B	Model C	Model D
Difficulty for participant of average ability level	3	0.77	0.76	0.77	0.75
	2	-0.06	-0.05	-0.18	-0.04
	1	-0.84	-0.82	-1.07	-0.78
	0	NA	NA	NA	NA
Cumulative probability for participant of average ability level	3	14.8%	15.3%	18.0%	13.4%
	2	53.9%	53.2%	59.3%	52.6%
	1	87.9%	87.0%	90.7%	88.1%
	0	100%	100%	100%	100%
Frequencies					
Groups	Points	Frequencies		Percent (%)	
Complete sample for this math problem (n = 535)	3	142		26.5%	
	2	140		26.2%	
	1	127		23.7%	
	0	126		23.6%	
Female (n = 166)	3	29		17.5%	
	2	32		19.3%	
	1	51		30.7%	
	0	54		32.5%	
Male (n = 364)	3	110		30.2%	
	2	107		29.4%	
	1	75		20.6%	
	0	72		19.8%	
German as primary language at home (n = 403)	3	107		26.6%	
	2	107		26.6%	
	1	92		22.8%	
	0	97		24.1%	
Other language as primary language at home (n = 131)	3	35		26.7%	
	2	32		24.4%	
	1	35		26.7%	
	0	29		22.1%	
Secondary school completed in Germany (n = 467)	3	121		25.9%	
	2	124		26.6%	
	1	109		23.3%	
	0	113		24.2%	

Frequencies			
Groups	Points	Frequencies	Percent (%)
Secondary school completed abroad (n = 67)	3	21	31.3%
	2	15	22.4%
	1	18	26.9%
	0	13	19.4%
Math not attended as advanced course in secondary school (n = 184)	3	12	6.5%
	2	23	12.5%
	1	65	35.3%
	0	84	45.7%
Math attended as advanced course in secondary school (n = 304)	3	113	37.2%
	2	109	35.9%
	1	54	17.8%
	0	28	9.2%
No math preparatory course attended (n = 243)	3	43	17.7%
	2	50	20.6%
	1	68	28.0%
	0	82	33.7%
Math preparatory course attended (n = 289)	3	98	33.9%
	2	88	30.4%
	1	59	20.4%
	0	44	15.2%
University of applied sciences (n = 143)	3	16	11.2%
	2	29	20.3%
	1	36	25.2%
	0	62	43.4%
University (n = 392)	3	126	32.1%
	2	111	28.3%
	1	91	23.2%
	0	64	16.3%
Online Participation (n = 359)	3	97	27.0%
	2	85	23.7%
	1	89	24.8%
	0	88	24.5%
Pen-and-Paper Participation (n = 176)	3	45	25.6%
	2	55	31.3%
	1	38	21.6%
	0	38	21.6%
Attended Gymnasium (n = 386)	3	119	30.8%
	2	116	30.1%
	1	88	22.8%
	0	63	16.3%
Attended Other Secondary School (n = 137)	3	21	15.3%
	2	20	14.6%
	1	38	27.7%
	0	58	42.3%

Note. Due to missing values on demographics questions, frequencies within groups may not add up to the total number of responses.

Plots

All plots are generated from **Model A7**.

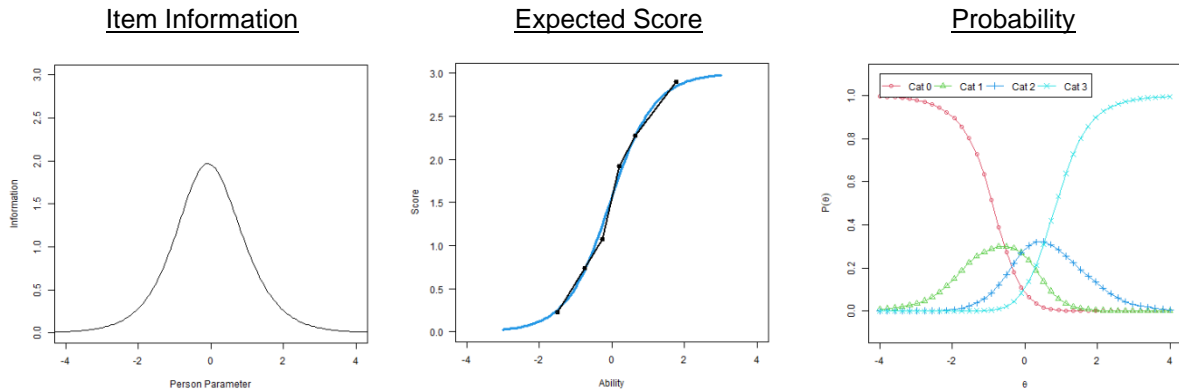

Note. The blue line represents expected performance, and the black line represents actual performance.

Note. Cat n = probability of receiving n points.

Differential Item Functioning (DIF)

This problem shows DIF based on attending math as an advanced or regular course in high school. The difficulty (β) was significantly lower for those who attended math as an advanced course. This shows that the problem was significantly easier for those who attended math as an advanced course in high school.

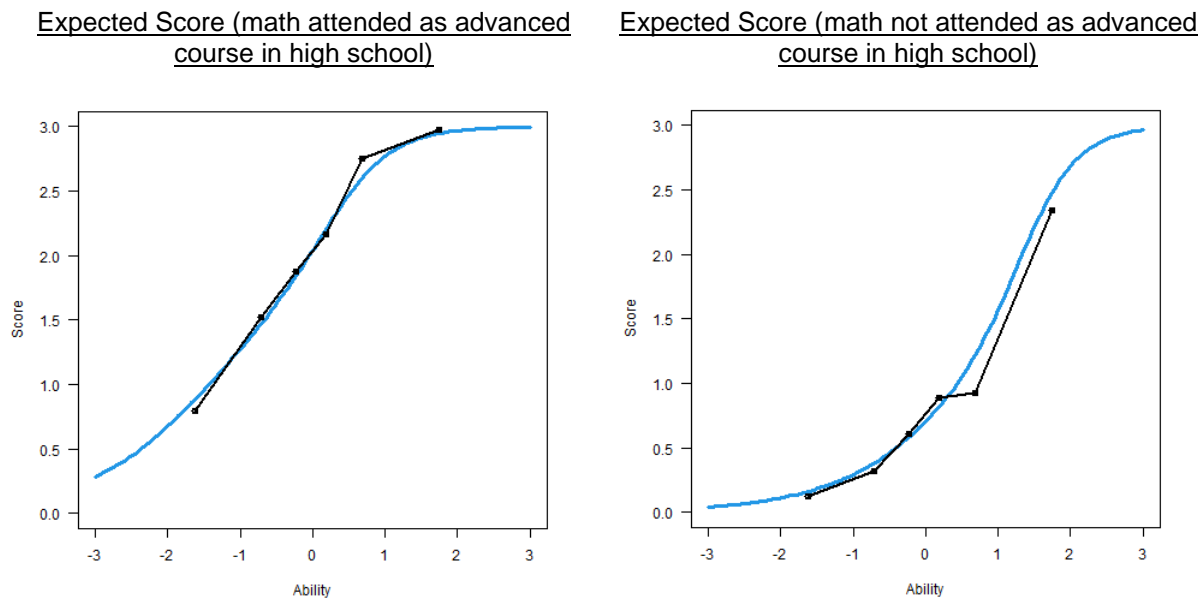

Note. The blue line represents expected performance, and the black line represents actual performance.

4.7.5. Parameters of a Sine Function (HF5)

Parameter einer Sinusfunktion

Abgebildet ist das Schaubild einer Funktion f , gegeben durch $f(x) = a \cdot \sin(b \cdot x) + c$.

Bestimmen Sie die Werte der Parameter und ergänzen Sie die freien Felder.

$a =$

$b =$

$c =$

Math Problem ID

HF5

Correct Answers and Answer Frequencies

Blank	Correct Answer(s)	Number Correct Answers	Number Incorrect Answers
1	blinded	blinded	blinded
2	blinded	blinded	blinded
3	blinded	blinded	blinded

Note. Scoring (PCS4): Every correct response is worth one point (up to 3 points possible).

Item Characteristics

Discrimination					
Measurement Type		Model A7	Model B	Model C	Model D
Correlation to participant ability (θ)		0.75	0.69	0.71	0.70
Discrimination Parameter (α)		1.43	1.25	1.16	1.41
Difficulty					
Measurement Type	Points	Model A7	Model B	Model C	Model D
Difficulty for participant of average ability level	3	1.29	1.37	1.47	1.32
	2	0.35	0.40	0.35	0.39
	1	-0.76	-0.72	-0.96	-0.70
	0	NA	NA	NA	NA
Cumulative probability for participant of average ability level	3	5.5%	6.2%	6.9%	5.3%
	2	32.7%	31.6%	35.4%	30.9%
	1	80.4%	76.9%	81.5%	78.3%
	0	100%	100%	100%	100%
Frequencies					
Groups	Points	Frequencies		Percent (%)	
Complete sample for this math problem (n = 541)	3	86		15.9%	
	2	127		23.5%	
	1	177		32.7%	
	0	151		27.9%	
Female (n = 171)	3	22		12.9%	
	2	23		13.5%	
	1	60		35.1%	
	0	66		38.6%	
Male (n = 366)	3	62		16.9%	
	2	103		28.1%	
	1	116		31.7%	
	0	85		23.2%	
German as primary language at home (n = 415)	3	58		14.0%	
	2	106		25.5%	
	1	140		33.7%	
	0	111		26.7%	
Other language as primary language at home (n = 125)	3	28		22.4%	
	2	21		16.8%	
	1	37		29.6%	
	0	39		31.2%	
Secondary school completed in Germany (n = 480)	3	66		13.8%	
	2	115		24.0%	
	1	162		33.8%	
	0	137		28.5%	

Frequencies			
Groups	Points	Frequencies	Percent (%)
Secondary school completed abroad (n = 60)	3	20	33.3%
	2	12	20.0%
	1	15	25.0%
	0	13	21.7%
Math not attended as advanced course in secondary school (n = 187)	3	13	7.0%
	2	21	11.2%
	1	60	32.1%
	0	93	49.7%
Math attended as advanced course in secondary school (n = 313)	3	65	20.8%
	2	98	31.3%
	1	107	34.2%
	0	43	13.7%
No math preparatory course attended (n = 240)	3	33	13.8%
	2	46	19.2%
	1	76	31.7%
	0	85	35.4%
Math preparatory course attended (n = 297)	3	52	17.5%
	2	80	26.9%
	1	99	33.3%
	0	66	22.2%
University of applied sciences (n = 142)	3	8	5.6%
	2	21	14.8%
	1	38	26.8%
	0	75	52.8%
University (n = 399)	3	78	19.5%
	2	106	26.6%
	1	139	34.8%
	0	76	19.0%
Online Participation (n = 363)	3	63	17.4%
	2	82	22.6%
	1	105	28.9%
	0	113	31.1%
Pen-and-Paper Participation (n = 178)	3	23	12.9%
	2	45	25.3%
	1	72	40.4%
	0	38	21.3%
Attended Gymnasium (n = 399)	3	70	17.5%
	2	101	25.3%
	1	141	35.3%
	0	87	21.8%
Attended Other Secondary School (n = 129)	3	13	10.1%
	2	25	19.4%
	1	33	25.6%
	0	58	45.0%

Note. Due to missing values on demographics questions, frequencies within groups may not add up to the total number of responses.

Plots

All plots are generated from **Model A7**.

Item Information

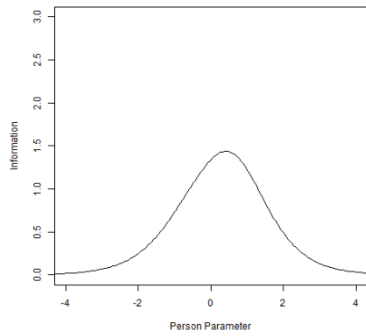

Expected Score

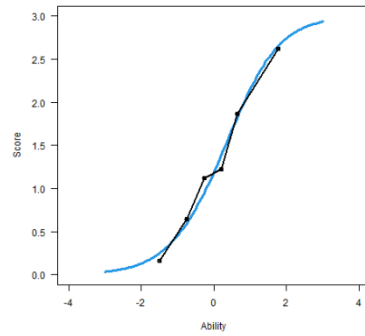

Note. The blue line represents expected performance, and the black line represents actual performance.

Probability

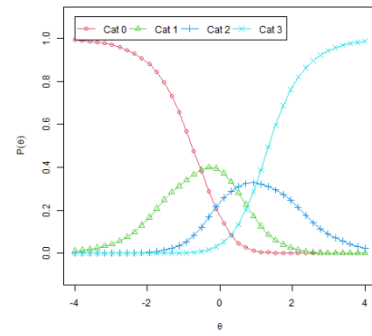

Note. Cat n = probability of receiving n points.

4.7.6. Value Tables (HF6)

Wertetabellen

Bestimmen Sie jeweils den fehlenden Funktionswert im gelben Feld der Wertetabelle so, dass die Tabelle

a) zu einer antiproportionalen,
 b) zu einer exponentiellen
 Funktion gehören könnte.

Hinweis: Neben der vertikalen ist auch die horizontale Lesart der Wertetabelle hilfreich.

Ergänzen Sie die freien Felder.

x	...	2	5	8	...
$f(x)$...	40	?	10	...

a)

b)

Math Problem ID

HF6

Correct Answers and Answer Frequencies

Math Problem Part	Correct Answer(s)	Number Correct Answers	Number Incorrect Answers
a)	blinded	blinded	blinded
b)	blinded	blinded	blinded

Note. Scoring (PCS4): Every correct response is worth one point (up to 2 points possible).

Item Characteristics

Discrimination					
Measurement Type		Model A7	Model B	Model C	Model D
Correlation to participant ability (θ)		0.43	0.39	0.40	0.38
Discrimination Parameter (α)		0.73	0.76	0.71	0.77
Difficulty					
Measurement Type	Points	Model A7	Model B	Model C	Model D
Difficulty for participant of average ability level	2	3.79	3.67	3.95	3.65
	1	0.91	0.88	0.86	0.89
	0	NA	NA	NA	NA
Cumulative probability for participant of average ability level	2	2.1%	2.1%	2.2%	2.1%
	1	32.6%	32.5%	34.1%	32.2%
	0	100%	100%	100%	100%
Frequencies					
Groups	Points	Frequencies	Percent (%)		
Complete sample for this math problem (n = 525)	2	20	3.8%		
	1	165	31.4%		
	0	340	64.8%		
Female (n = 162)	2	2	1.2%		
	1	41	25.3%		
	0	119	73.5%		
Male (n = 358)	2	17	4.7%		
	1	121	33.8%		
	0	220	61.5%		
German as primary language at home (n = 396)	2	13	3.3%		
	1	128	32.3%		
	0	255	64.4%		
Other language as primary language at home (n = 128)	2	7	5.5%		
	1	36	28.1%		
	0	85	66.4%		
Secondary school completed in Germany (n = 458)	2	17	3.7%		
	1	144	31.4%		
	0	297	64.8%		
Secondary school completed abroad (n = 66)	2	3	4.5%		
	1	20	30.3%		
	0	43	65.2%		
Math not attended as advanced course in secondary school (n = 178)	2	2	1.1%		
	1	40	22.5%		
	0	136	76.4%		
Math attended as advanced course in secondary school (n = 301)	2	17	5.6%		
	1	113	37.5%		
	0	171	56.8%		

Frequencies			
Groups	Points	Frequencies	Percent (%)
No math preparatory course attended (n = 237)	2	8	3.4%
	1	74	31.2%
	0	155	65.4%
Math preparatory course attended (n = 285)	2	12	4.2%
	1	88	30.9%
	0	185	64.9%
University of applied sciences (n = 138)	2	2	1.4%
	1	36	26.1%
	0	100	72.5%
University (n = 387)	2	18	4.7%
	1	129	33.3%
	0	240	62.0%
Online Participation (n = 349)	2	12	3.4%
	1	113	32.4%
	0	224	64.2%
Pen-and-Paper Participation (n = 176)	2	8	4.5%
	1	52	29.5%
	0	116	65.9%
Attended Gymnasium (n = 379)	2	18	4.7%
	1	122	32.2%
	0	239	63.1%
Attended Other Secondary School (n = 135)	2	2	1.5%
	1	41	30.4%
	0	92	68.1%

Note. Due to missing values on demographics questions, frequencies within groups may not add up to the total number of responses.

Plots

All plots are generated from **Model A7**.

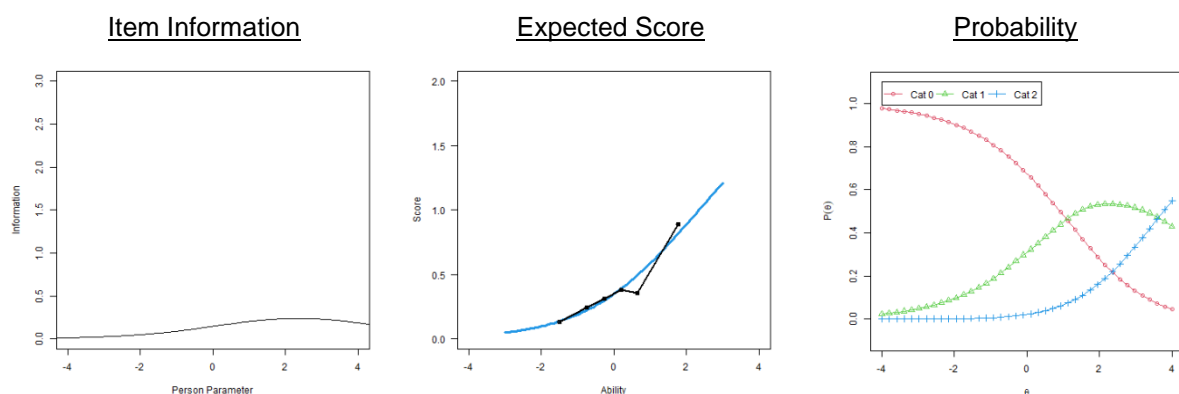

Note. The blue line represents expected performance, and the black line represents actual performance.

Note. Cat n = probability of receiving n points.

4.7.7. Composite Functions (HF7)

Kompositionen

Gegeben sind die Funktionen $g(x) = \cos(x)$ und $h(x) = 3^{x+1}$. Welche der folgenden Möglichkeiten vervollständigt jeweils die Gleichung korrekt?

Wählen Sie jeweils die richtige Antwort.

a)

$$g(h(x)) =$$

$$\cos(3^{x+1})$$

A

$$(\cos(3))^{x+1}$$

B

$$\cos(3^x) + 1$$

C

b)

$$h(g(x)) =$$

$$3^{\cos(x+1)}$$

A

$$3^{\cos(x)+1}$$

B

$$3^{\cos(x)} + 1$$

C

Math Problem ID

HF7

Correct Answers and Answer Frequencies

Math Problem Part	Correct Answer	Number Correct Answers	Number Incorrect Answers ^a	Answer Frequencies		
				A	B	C
a)	blinded	blinded	blinded	blinded	blinded	blinded
b)	blinded	blinded	blinded	blinded	blinded	blinded

Note. Scoring (PCS4): Every correct response is worth one point (up to 2 points possible).

^a Includes cases, where the problem was seen but not answered.

Item Characteristics

Discrimination						
Measurement Type		Model A7	Model B	Model C	Model D	
Correlation to participant ability (θ)		0.59	0.58	0.58	0.60	
Discrimination Parameter (α)		1.87	1.69	1.47	1.93	
Difficulty						
Measurement Type		Points	Model A7	Model B	Model C	Model D
Difficulty for participant of average ability level		2	-0.90	-0.84	-1.11	-0.82
		1	-1.42	-1.36	-1.76	-1.33
		0	NA	NA	NA	NA
Cumulative probability for participant of average ability level		2	88.5%	85.9%	88.1%	87.6%
		1	98.8%	97.9%	98.7%	98.6%
		0	100%	100%	100%	100%
Frequencies						
Groups		Points	Frequencies		Percent (%)	
Complete sample for this math problem (n = 545)		2	412		75.6%	
		1	73		13.4%	
		0	60		11.0%	
Female (n = 175)		2	122		69.7%	
		1	30		17.1%	
		0	23		13.1%	
Male (n = 366)		2	286		78.1%	
		1	43		11.7%	
		0	37		10.1%	
German as primary language at home (n = 418)		2	310		74.2%	
		1	60		14.4%	
		0	48		11.5%	
Other language as primary language at home (n = 126)		2	101		80.2%	
		1	13		10.3%	
		0	12		9.5%	
Secondary school completed in Germany (n = 484)		2	357		73.8%	
		1	70		14.5%	
		0	57		11.8%	

Frequencies			
Groups	Points	Frequencies	Percent (%)
Secondary school completed abroad (n = 60)	2	54	90.0%
	1	3	5.0%
	0	3	5.0%
Math not attended as advanced course in secondary school (n = 190)	2	97	51.1%
	1	53	27.9%
	0	40	21.1%
Math attended as advanced course in secondary school (n = 314)	2	282	89.8%
	1	19	6.1%
	0	13	4.1%
No math preparatory course attended (n = 242)	2	170	70.2%
	1	35	14.5%
	0	37	15.3%
Math preparatory course attended (n = 299)	2	238	79.6%
	1	38	12.7%
	0	23	7.7%
University of applied sciences (n = 142)	2	72	50.7%
	1	34	23.9%
	0	36	25.4%
University (n = 403)	2	340	84.4%
	1	39	9.7%
	0	24	6.0%
Online Participation (n = 367)	2	269	73.3%
	1	55	15.0%
	0	43	11.7%
Pen-and-Paper Participation (n = 178)	2	143	80.3%
	1	18	10.1%
	0	17	9.6%
Attended Gymnasium (n = 403)	2	331	82.1%
	1	44	10.9%
	0	28	6.9%
Attended Other Secondary School (n = 129)	2	73	56.6%
	1	27	20.9%
	0	29	22.5%

Note. Due to missing values on demographics questions, frequencies within groups may not add up to the total number of responses.

Plots

All plots are generated from **Model A7**.

Item Information

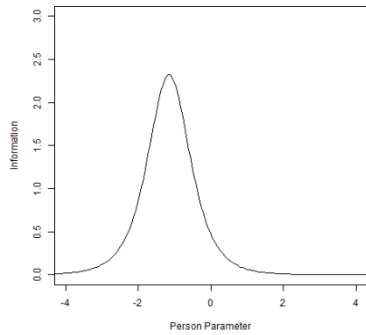

Expected Score

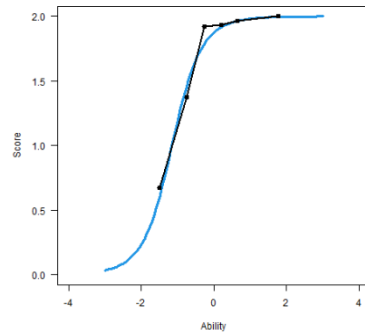

Probability

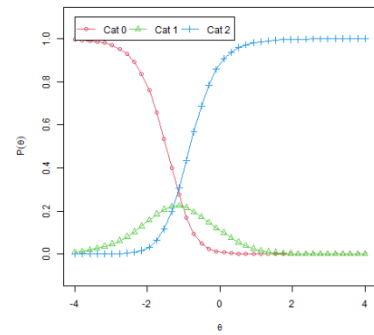

Note. The blue line represents expected performance, and the black line represents actual performance.

Note. Cat n = probability of receiving n points.

4.7.8. Functions in Applied Contexts (HF8)

Funktionen im Sachkontext

Wählen Sie für jeden der folgenden Sachkontexte jeweils einen Funktionentyp, der geeignet ist, diesen zu beschreiben.

a)
Dem Volumen eines Würfels wird seine Kantenlänge zugeordnet.

Wurzelfunktion	A
Potenzfunktion	B
Exponentielle Funktion	C
Antiproportionale Funktion	D

b)
Bei einer vorgegebenen Fahrstrecke wird der Durchschnittsgeschwindigkeit die Fahrzeit zugeordnet.

Wurzelfunktion	A
Potenzfunktion	B
Exponentielle Funktion	C
Antiproportionale Funktion	D

Math Problem ID

HF8

Correct Answers and Answer Frequencies

Math Problem Part	Correct Answer	Number Correct Answers	Number Incorrect Answers ^a	Answer Frequencies			
				A	B	C	D
a)	blinded	blinded	blinded	blinded	blinded	blinded	blinded
b)	blinded	blinded	blinded	blinded	blinded	blinded	blinded

Note. Scoring (PCS4): Every correct response is worth one point (up to 2 points possible).

^a Includes cases, where the problem was seen but not answered.

Item Characteristics

Discrimination					
Measurement Type		Model A7	Model B	Model C	Model D
Correlation to participant ability (θ)		0.47	0.45	0.46	0.44
Discrimination Parameter (α)		0.72	0.74	0.68	0.77
Difficulty					
Measurement Type	Points	Model A7	Model B	Model C	Model D
Difficulty for participant of average ability level	2	2.01	1.94	2.06	1.91
	1	-0.25	-0.24	-0.38	-0.22
	0	NA	NA	NA	NA
Cumulative probability for participant of average ability level	2	12.7%	12.7%	13.5%	12.3%
	1	55.4%	55.3%	57.8%	55.0%
	0	100%	100%	100%	100%
Frequencies					
Groups	Points	Frequencies		Percent (%)	
Complete sample for this math problem (n = 533)	2	88		16.5%	
	1	210		39.4%	
	0	235		44.1%	
Female (n = 165)	2	14		8.5%	
	1	67		40.6%	
	0	84		50.9%	
Male (n = 363)	2	71		19.6%	
	1	142		39.1%	
	0	150		41.3%	
German as primary language at home (n = 401)	2	77		19.2%	
	1	158		39.4%	
	0	166		41.4%	
Other language as primary language at home (n = 131)	2	11		8.4%	
	1	51		38.9%	
	0	69		52.7%	
Secondary school completed in Germany (n = 465)	2	81		17.4%	
	1	179		38.5%	
	0	205		44.1%	
Secondary school completed abroad (n = 67)	2	7		10.4%	
	1	30		44.8%	
	0	30		44.8%	
Math not attended as advanced course in secondary school (n = 182)	2	17		9.3%	
	1	59		32.4%	
	0	106		58.2%	
Math attended as advanced course in secondary school (n = 304)	2	62		20.4%	
	1	133		43.8%	
	0	109		35.9%	

Frequencies			
Groups	Points	Frequencies	Percent (%)
No math preparatory course attended (n = 242)	2	26	10.7%
	1	86	35.5%
	0	130	53.7%
Math preparatory course attended (n = 288)	2	60	20.8%
	1	123	42.7%
	0	105	36.5%
University of applied sciences (n = 142)	2	13	9.2%
	1	45	31.7%
	0	84	59.2%
University (n = 391)	2	75	19.2%
	1	165	42.2%
	0	151	38.6%
Online Participation (n = 357)	2	63	17.6%
	1	137	38.4%
	0	157	44.0%
Pen-and-Paper Participation (n = 176)	2	25	14.2%
	1	73	41.5%
	0	78	44.3%
Attended Gymnasium (n = 385)	2	74	19.2%
	1	157	40.8%
	0	154	40.0%
Attended Other Secondary School (n = 137)	2	13	9.5%
	1	49	35.8%
	0	75	54.7%

Note. Due to missing values on demographics questions, frequencies within groups may not add up to the total number of responses.

Plots

All plots are generated from **Model A7**.

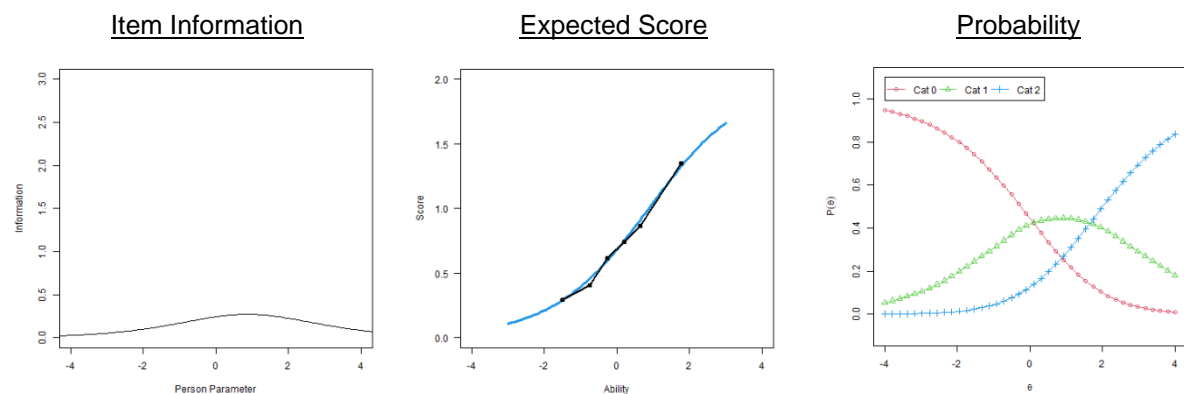

Note. The blue line represents expected performance, and the black line represents actual performance.

Note. Cat n = probability of receiving n points.

4.7.9. Domain of a Function (HF9)

Definitionsbereich

Sei f eine Funktion mit $f(x) = y, x \in D, y \in W$. Vervollständigen Sie die folgende Aussage.

Schränkt man den Definitionsbereich D von f ein, dann...

Wählen Sie die richtige Antwort.

...wird der Wertebereich W immer kleiner. A

...wird der Wertebereich W immer größer. B

...bleibt der Wertebereich W unverändert. C

...lässt sich keine allgemeine Aussage über den Wertebereich W treffen (es kommt auf die Funktion an). D

Math Problem ID

HF9

Correct Answers and Answer Frequencies

Correct Answer	Number Correct Answers	Number Incorrect Answers ^a	Answer Frequencies			
			A	B	C	D
blinded	blinded	blinded	blinded	blinded	blinded	blinded

Note. Scoring (PCS4): Every correct response is worth one point (up to 1 point possible).

^a Includes cases, where the problem was seen but not answered.

Item Characteristics

Discrimination					
Measurement Type		Model A7	Model B	Model C	Model D
Correlation to participant ability (θ)		0.41	0.38	0.39	0.38
Discrimination Parameter (α)		0.88	0.87	0.79	0.92
Difficulty					
Measurement Type	Points	Model A7	Model B	Model C	Model D
Difficulty for participant of average ability level	1	0.17	0.17	0.07	0.18
	0	NA	NA	NA	NA
Cumulative probability for participant of average ability level	1	46.3%	46.3%	48.5%	45.9%
	0	100%	100%	100%	100%

Frequencies			
Groups	Points	Frequencies	Percent (%)
Complete sample for this math problem (n = 529)	1	251	47.4%
	0	278	52.6%
Female (n = 163)	1	71	43.6%
	0	92	56.4%
Male (n = 361)	1	176	48.8%
	0	185	51.2%
German as primary language at home (n = 399)	1	190	47.6%
	0	209	52.4%
Other language as primary language at home (n = 129)	1	60	46.5%
	0	69	53.5%
Secondary school completed in Germany (n = 461)	1	212	46.0%
	0	249	54.0%
Secondary school completed abroad (n = 67)	1	38	56.7%
	0	29	43.3%
Math not attended as advanced course in secondary school (n = 179)	1	59	33.0%
	0	120	67.0%
Math attended as advanced course in secondary school (n = 303)	1	169	55.8%
	0	134	44.2%
No math preparatory course attended (n = 239)	1	94	39.3%
	0	145	60.7%
Math preparatory course attended (n = 287)	1	154	53.7%
	0	133	46.3%
University of applied sciences (n = 140)	1	44	31.4%
	0	96	68.6%
University (n = 389)	1	207	53.2%
	0	182	46.8%
Online Participation (n = 353)	1	159	45.0%
	0	194	55.0%
Pen-and-Paper Participation (n = 176)	1	92	52.3%
	0	84	47.7%
Attended Gymnasium (n = 382)	1	194	50.8%
	0	188	49.2%
Attended Other Secondary School (n = 136)	1	52	38.2%
	0	84	61.8%

Note. Due to missing values on demographics questions, frequencies within groups may not add up to the total number of responses.

Plots

All plots are generated from **Model A7**.

Item Information

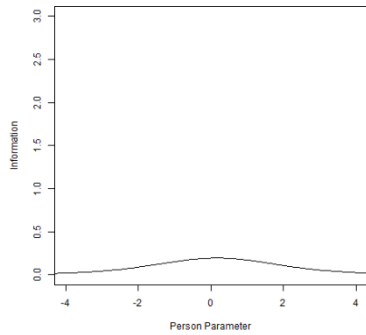

Expected Score

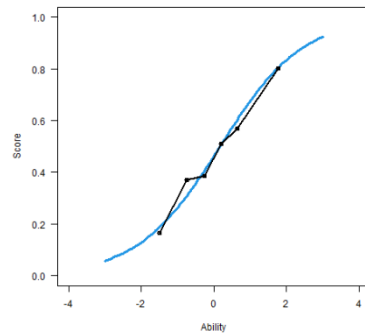

Note. The blue line represents expected performance, and the black line represents actual performance.

Probability

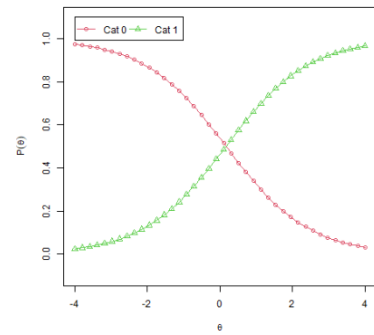

Note. Cat n = probability of receiving n points.

4.7.10. Domain and Value Sets of Higher Functions (HF10)

Definitions- und Wertemengen von höheren Funktionen

Wählen Sie für jede der folgende Funktionen jeweils die korrekte Aussage über die maximale reelle Definitionsmenge D und Wertebereich W .

a)

$$f(x) = e^x$$

$$D = \mathbb{R} \text{ und } W = \mathbb{R}^{>0}$$

A

$$D = \mathbb{R} \text{ und } W = \mathbb{R}^{\geq 0}$$

B

$$D = \mathbb{R} \text{ und } W = \mathbb{R}$$

C

$$D = \mathbb{R}^{>0} \text{ und } W = \mathbb{R}^{>0}$$

D

$$D = \mathbb{R}^{\geq 0} \text{ und } W = \mathbb{R}^{\geq 0}$$

E

b)

$$g(x) = \sqrt{x}$$

$$D = \mathbb{R} \text{ und } W = \mathbb{R}^{>0}$$

A

$$D = \mathbb{R} \text{ und } W = \mathbb{R}^{\geq 0}$$

B

$$D = \mathbb{R} \text{ und } W = \mathbb{R}$$

C

$$D = \mathbb{R}^{>0} \text{ und } W = \mathbb{R}^{>0}$$

D

$$D = \mathbb{R}^{\geq 0} \text{ und } W = \mathbb{R}^{\geq 0}$$

E

Math Problem ID

HF10

Correct Answers and Answer Frequencies

Math Problem Part	Correct Answer	Number Correct Answers	Number Incorrect Answers ^a	Answer Frequencies				
				A	B	C	D	E
a)	blinded	blinded	blinded	blinded	blinded	blinded	blinded	blinded
b)	blinded	blinded	blinded	blinded	blinded	blinded	blinded	blinded

Note. Scoring (PCS4): Every correct response is worth one point (up to 2 points possible).

^a Includes cases, where the problem was seen but not answered.

Item Characteristics

Discrimination					
Measurement Type		Model A7	Model B	Model C	Model D
Correlation to participant ability (θ)		0.71	0.67	0.68	0.68
Discrimination Parameter (α)		1.74	1.49	1.34	1.74
Difficulty					
Measurement Type	Points	Model A7	Model B	Model C	Model D
Difficulty for participant of average ability level	2	0.27	0.33	0.27	0.32
	1	-0.46	-0.42	-0.62	-0.41
	0	NA	NA	NA	NA
Cumulative probability for participant of average ability level	2	34.6%	33.4%	38.0%	32.3%
	1	75.1%	70.6%	76.2%	72.4%
	0	100%	100%	100%	100%
Frequencies					
Groups	Points	Frequencies		Percent (%)	
Complete sample for this math problem (n = 544)	2	217		39.9%	
	1	140		25.7%	
	0	187		34.4%	
Female (n = 174)	2	58		33.3%	
	1	49		28.2%	
	0	67		38.5%	
Male (n = 366)	2	156		42.6%	
	1	91		24.9%	
	0	119		32.5%	
German as primary language at home (n = 417)	2	165		39.6%	
	1	102		24.5%	
	0	150		36.0%	
Other language as primary language at home (n = 126)	2	52		41.3%	
	1	37		29.4%	
	0	37		29.4%	
Secondary school completed in Germany (n = 483)	2	185		38.3%	
	1	130		26.9%	
	0	168		34.8%	

Frequencies			
Groups	Points	Frequencies	Percent (%)
Secondary school completed abroad (n = 60)	2	32	53.3%
	1	10	16.7%
	0	18	30.0%
Math not attended as advanced course in secondary school (n = 189)	2	27	14.3%
	1	55	29.1%
	0	107	56.6%
Math attended as advanced course in secondary school (n = 314)	2	172	54.8%
	1	80	25.5%
	0	62	19.7%
No math preparatory course attended (n = 242)	2	62	25.6%
	1	68	28.1%
	0	112	46.3%
Math preparatory course attended (n = 298)	2	153	51.3%
	1	71	23.8%
	0	74	24.8%
University of applied sciences (n = 142)	2	27	19.0%
	1	39	27.5%
	0	76	53.5%
University (n = 402)	2	190	47.3%
	1	101	25.1%
	0	111	27.6%
Online Participation (n = 366)	2	135	36.9%
	1	97	26.5%
	0	134	36.6%
Pen-and-Paper Participation (n = 178)	2	82	46.1%
	1	43	24.2%
	0	53	29.8%
Attended Gymnasium (n = 402)	2	183	45.5%
	1	108	26.9%
	0	111	27.6%
Attended Other Secondary School (n = 129)	2	31	24.0%
	1	31	24.0%
	0	67	51.9%

Note. Due to missing values on demographics questions, frequencies within groups may not add up to the total number of responses.

Plots

All plots are generated from **Model A7**.

Item Information

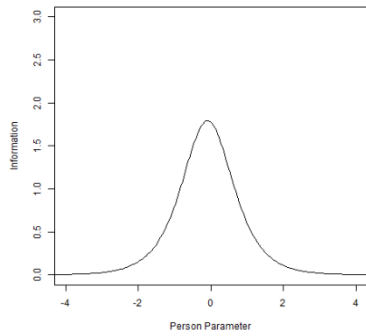

Expected Score

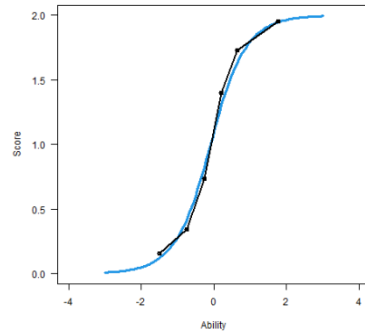

Probability

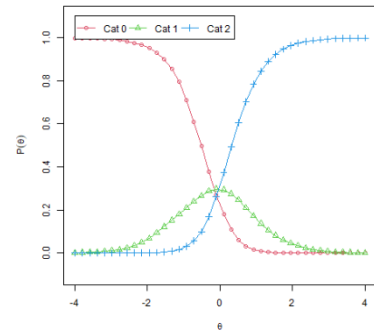

Note. The blue line represents expected performance, and the black line represents actual performance.

Note. Cat n = probability of receiving n points.

4.8. Differential Calculus (Differentialrechnung; D)

Q₃ Statistics for Differential Calculus

	D1	D2	D3	D4	D5	D6	D7	D8	D9	D10	D11
D1	-										
D2	.300	-									
D3	-.126	-.136	-								
D4	.163	.254	-.136	-							
D5	-.111	-.157	-.039	-.052	-						
D6	.233	.291	-.208	.064	-.121	-					
D7	-.160	-.109	.000	-.222	-.104	-.159	-				
D8	-.238	-.233	-.057	-.192	.004	-.244	-.021	-			
D9	.057	-.004	-.043	-.035	-.028	-.003	-.199	-.124	-		
D10	-.086	-.086	-.011	.061	-.005	-.148	.055	-.006	-.104	-	
D11	-.201	-.254	.026	-.213	.029	-.346	-.072	.035	-.093	.041	-

Note. Q₃ statistics above the critical absolute value of 0.20 are bolded. For details see **Section 3.1**.

4.8.1. First Derivative of Polynomial Functions (D1)

1. Ableitung von Polynomfunktionen

Gegeben sei die Funktion f mit $f(x) = \frac{1}{4}x^2 + 2x + 4$. Bestimmen Sie die 1. Ableitung von f .

Ergänzen Sie das freie Feld.

Schreibweise:
Nutzen Sie folgende Zeichen: + (Addition), - (Subtraktion), * (Multiplikation), / (Division), ^ (Potenz).

$f'(x) =$

Math Problem ID

D1

Correct Answers and Answer Frequencies

Correct Answer(s)	Number Correct Answers	Number Incorrect Answers
blinded	blinded	blinded

Note. Scoring (PCS4): Every correct response is worth one point (up to 1 point possible).

Item Characteristics

Discrimination					
Measurement Type		Model A8	Model B	Model C	Model D
Correlation to participant ability (θ)		0.52	0.50	0.49	0.52
Discrimination Parameter (α)		1.86	1.87	1.59	2.02
Difficulty					
Measurement Type	Points	Model A8	Model B	Model C	Model D
Difficulty for participant of average ability level	1	-1.17	-1.12	-1.29	-1.08
	0	NA	NA	NA	NA
Cumulative probability for participant of average ability level	1	89.9%	89.1%	88.7%	89.9%
	0	100%	100%	100%	100%
Frequencies					
Groups	Points	Frequencies		Percent (%)	
Complete sample for this math problem (n = 546)	1	443		81.1%	
	0	103		18.9%	
Female (n = 177)	1	138		78.0%	
	0	39		22.0%	
Male (n = 361)	1	298		82.5%	
	0	63		17.5%	

Frequencies			
Groups	Points	Frequencies	Percent (%)
German as primary language at home (n = 412)	1	333	80.8%
	0	79	19.2%
Other language as primary language at home (n = 130)	1	106	81.5%
	0	24	18.5%
Secondary school completed in Germany (n = 484)	1	388	80.2%
	0	96	19.8%
Secondary school completed abroad (n = 59)	1	52	88.1%
	0	7	11.9%
Math not attended as advanced course in secondary school (n = 171)	1	104	60.8%
	0	67	39.2%
Math attended as advanced course in secondary school (n = 321)	1	290	90.3%
	0	31	9.7%
No math preparatory course attended (n = 240)	1	176	73.3%
	0	64	26.7%
Math preparatory course attended (n = 300)	1	261	87.0%
	0	39	13.0%
University of applied sciences (n = 138)	1	88	63.8%
	0	50	36.2%
University (n = 408)	1	355	87.0%
	0	53	13.0%
Online Participation (n = 378)	1	307	81.2%
	0	71	18.8%
Pen-and-Paper Participation (n = 168)	1	136	81.0%
	0	32	19.0%
Attended Gymnasium (n = 405)	1	335	82.7%
	0	70	17.3%
Attended Other Secondary School (n = 126)	1	96	76.2%
	0	30	23.8%

Note. Due to missing values on demographics questions, frequencies within groups may not add up to the total number of responses.

Plots

All plots are generated from **Model A8**.

Item Information

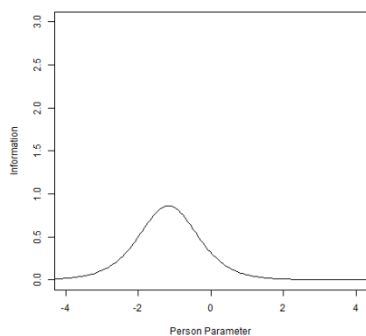

Expected Score

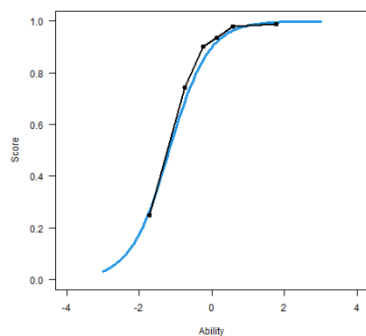

Probability

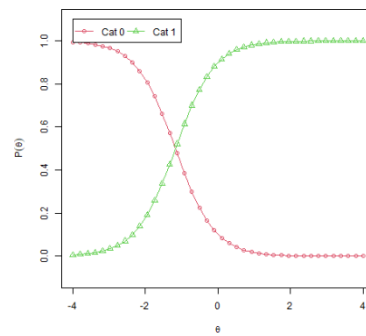

Note. The blue line represents expected performance, and the black line represents actual performance.

Note. Cat n = probability of receiving n points.

4.8.2. Laws of Derivatives (D2)

Ableitungsregeln

Seien u und v differenzierbare Funktionen. Welcher Term entspricht jeweils der Ableitung der Funktion von $f(x)$?

Wählen Sie jeweils die richtige Antwort.

a)
 $f(x) = u(x) \cdot v(x)$

$f'(x) = u'(x) \cdot v'(x)$ A

$f'(x) = u(x) \cdot v(x) + u'(x) \cdot v'(x)$ B

$f'(x) = u'(x) \cdot v(x) + u(x) \cdot v'(x)$ C

$f'(x) = u'(x) \cdot v(x) - u(x) \cdot v'(x)$ D

b)
 $f(x) = u(v(x))$

$f'(x) = u'(x) \cdot v'(x)$ A

$f'(x) = u'(v'(x)) \cdot v'(x)$ B

$f'(x) = u'(v(x)) \cdot v'(x)$ C

$f'(x) = u'(v'(x))$ D

Math Problem ID

D2

Correct Answers and Answer Frequencies

Math Problem Part	Correct Answer	Number Correct Answers	Number Incorrect Answers ^a	Answer Frequencies			
				A	B	C	D
a)	blinded	blinded	blinded	blinded	blinded	blinded	blinded
b)	blinded	blinded	blinded	blinded	blinded	blinded	blinded

Note. Scoring (PCS4): Every correct response is worth one point (up to 2 points possible).

^a Includes cases, where the problem was seen but not answered.

Item Characteristics

Discrimination					
Measurement Type		Model A8	Model B	Model C	Model D
Correlation to participant ability (θ)		0.69	0.61	0.61	0.62
Discrimination Parameter (α)		2.00	1.41	1.33	1.82
Difficulty					
Measurement Type	Points	Model A8	Model B	Model C	Model D
Difficulty for participant of average ability level	2	-0.47	-0.49	-0.61	-0.44
	1	-1.12	-1.19	-1.38	-1.10
	0	NA	NA	NA	NA
Cumulative probability for participant of average ability level	2	75.6%	70.8%	74.0%	72.9%
	1	96.9%	93.4%	94.8%	95.6%
	0	100%	100%	100%	100%
Frequencies					
Groups	Points	Frequencies		Percent (%)	
Complete sample for this math problem (n = 545)	2	354		65.0%	
	1	105		19.3%	
	0	86		15.8%	
Female (n = 177)	2	115		65.0%	
	1	30		16.9%	
	0	32		18.1%	
Male (n = 360)	2	233		64.7%	
	1	73		20.3%	
	0	54		15.0%	
German as primary language at home (n = 411)	2	266		64.7%	
	1	82		20.0%	
	0	63		15.3%	
Other language as primary language at home (n = 130)	2	85		65.4%	
	1	22		16.9%	
	0	23		17.7%	
Secondary school completed in Germany (n = 483)	2	312		64.6%	
	1	93		19.3%	
	0	78		16.1%	
Secondary school completed abroad (n = 59)	2	41		69.5%	
	1	10		16.9%	
	0	8		13.6%	
Math not attended as advanced course in secondary school (n = 171)	2	74		43.3%	
	1	48		28.1%	
	0	49		28.7%	
Math attended as advanced course in secondary school (n = 320)	2	244		76.3%	
	1	50		15.6%	
	0	26		8.1%	

Frequencies			
Groups	Points	Frequencies	Percent (%)
No math preparatory course attended (n = 240)	2	131	54.6%
	1	58	24.2%
	0	51	21.3%
Math preparatory course attended (n = 299)	2	219	73.2%
	1	45	15.1%
	0	35	11.7%
University of applied sciences (n = 137)	2	52	38.0%
	1	36	26.3%
	0	49	35.8%
University (n = 408)	2	302	74.0%
	1	69	16.9%
	0	37	9.1%
Online Participation (n = 377)	2	238	63.1%
	1	70	18.6%
	0	69	18.3%
Pen-and-Paper Participation (n = 168)	2	116	69.0%
	1	35	20.8%
	0	17	10.1%
Attended Gymnasium (n = 404)	2	277	68.6%
	1	68	16.8%
	0	59	14.6%
Attended Other Secondary School (n = 126)	2	69	54.8%
	1	32	25.4%
	0	25	19.8%

Note. Due to missing values on demographics questions, frequencies within groups may not add up to the total number of responses.

Plots

All plots are generated from **Model A8**.

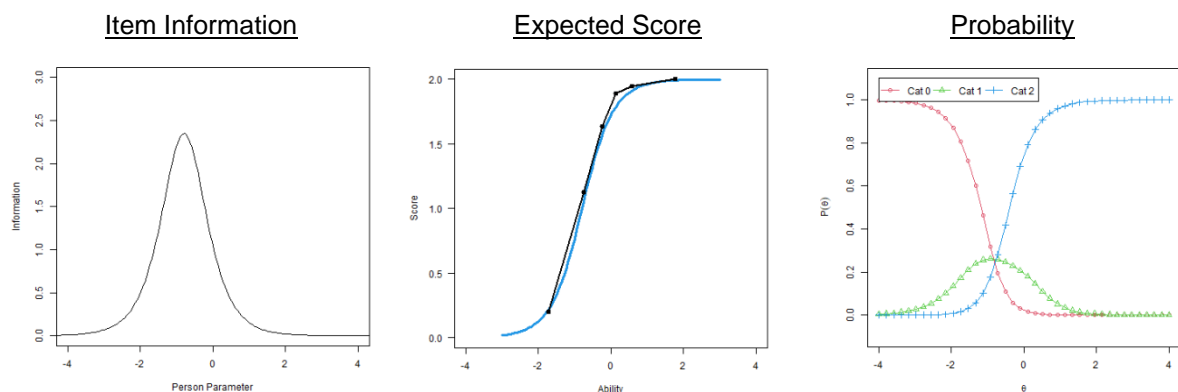

Note. The blue line represents expected performance, and the black line represents actual performance.

Note. Cat n = probability of receiving n points.

4.8.3. Meaning of the First and Second Derivative (D3)

Bedeutung der 1. und 2. Ableitung

Gegeben sei eine ganzrationale Funktion f dritten Grades, für die alle folgenden Aussagen gelten:

- $f''(x) < 0$ für $x < 1$ und $f''(x) > 0$ für $x > 1$.
- $f(0) = 10$.

Welcher der nachfolgenden Graphen gehört zu f ?

Wählen Sie die richtige Antwort.

A

B

C

Math Problem ID

D3

Correct Answers and Answer Frequencies

Correct Answer	Number Correct Answers	Number Incorrect Answers ^a	Answer Frequencies		
			A	B	C
blinded	blinded	blinded	blinded	blinded	blinded

Note. Scoring (PCS4): Every correct response is worth one point (up to 1 point possible).

^a Includes cases, where the problem was seen but not answered.

Item Characteristics

Discrimination					
Measurement Type		Model A8	Model B	Model C	Model D
Correlation to participant ability (θ)		0.39	0.34	0.34	0.34
Discrimination Parameter (α)		0.80	0.74	0.68	0.80
Difficulty					
Measurement Type	Points	Model A8	Model B	Model C	Model D
Difficulty for participant of average ability level	1	-0.34	-0.26	-0.38	-0.25
	0	NA	NA	NA	NA
Cumulative probability for participant of average ability level	1	56.7%	54.7%	56.3%	55.1%
	0	100%	100%	100%	100%

Frequencies			
Groups	Points	Frequencies	Percent (%)
Complete sample for this math problem (n = 546)	1	307	56.2%
	0	239	43.8%
Female (n = 182)	1	102	56.0%
	0	80	44.0%
Male (n = 357)	1	199	55.7%
	0	158	44.3%
German as primary language at home (n = 420)	1	241	57.4%
	0	179	42.6%
Other language as primary language at home (n = 125)	1	66	52.8%
	0	59	47.2%
Secondary school completed in Germany (n = 497)	1	285	57.3%
	0	212	42.7%
Secondary school completed abroad (n = 47)	1	22	46.8%
	0	25	53.2%
Math not attended as advanced course in secondary school (n = 178)	1	80	44.9%
	0	98	55.1%
Math attended as advanced course in secondary school (n = 325)	1	202	62.2%
	0	123	37.8%
No math preparatory course attended (n = 234)	1	119	50.9%
	0	115	49.1%
Math preparatory course attended (n = 307)	1	184	59.9%
	0	123	40.1%
University of applied sciences (n = 134)	1	51	38.1%
	0	83	61.9%
University (n = 412)	1	256	62.1%
	0	156	37.9%
Online Participation (n = 376)	1	212	56.4%
	0	164	43.6%
Pen-and-Paper Participation (n = 170)	1	95	55.9%
	0	75	44.1%
Attended Gymnasium (n = 415)	1	245	59.0%
	0	170	41.0%
Attended Other Secondary School (n = 118)	1	54	45.8%
	0	64	54.2%

Note. Due to missing values on demographics questions, frequencies within groups may not add up to the total number of responses.

Plots

All plots are generated from **Model A8**.

Item Information

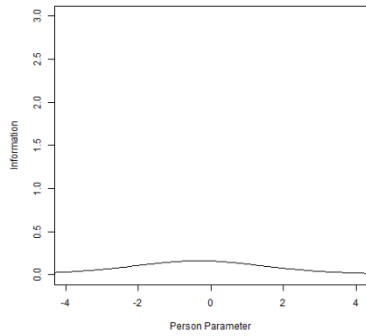

Expected Score

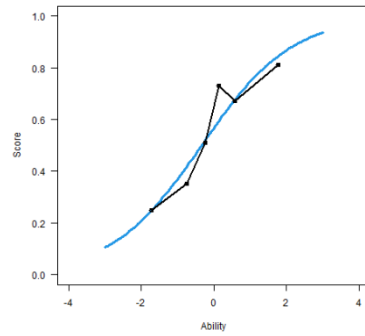

Probability

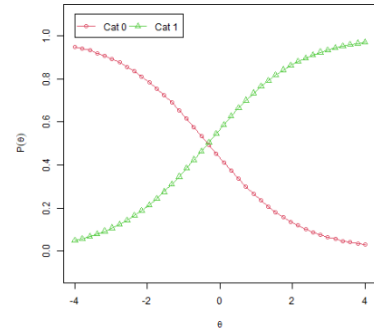

Note. The blue line represents expected performance, and the black line represents actual performance.

Note. Cat n = probability of receiving n points.

4.8.4. Derivative Function (D4)

Ableitungsfunktion

Wählen Sie für die beiden folgenden Graphen einer Funktion jeweils den zugehörigen Graphen seiner Ableitungsfunktionen.

a)

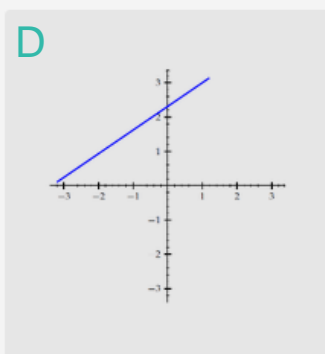
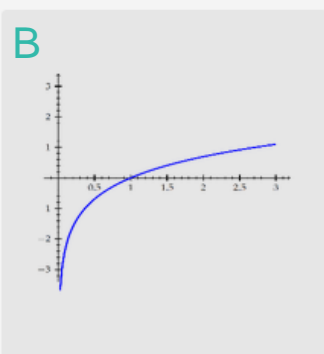
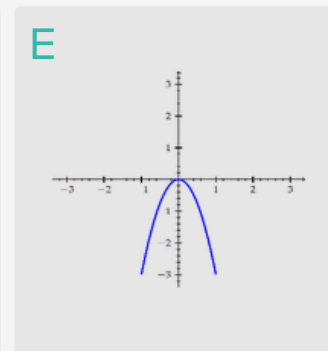
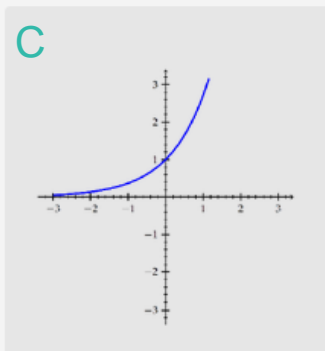
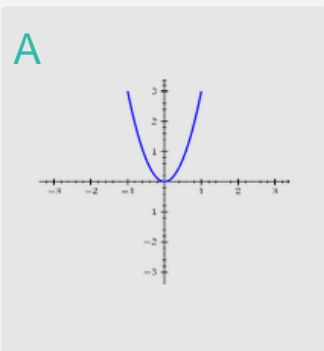
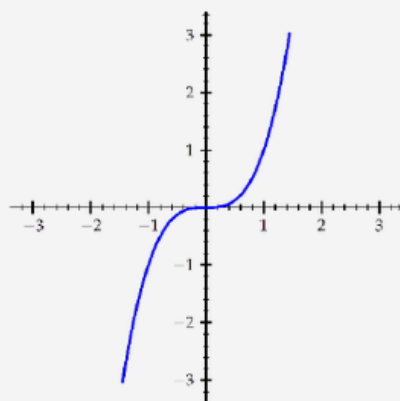

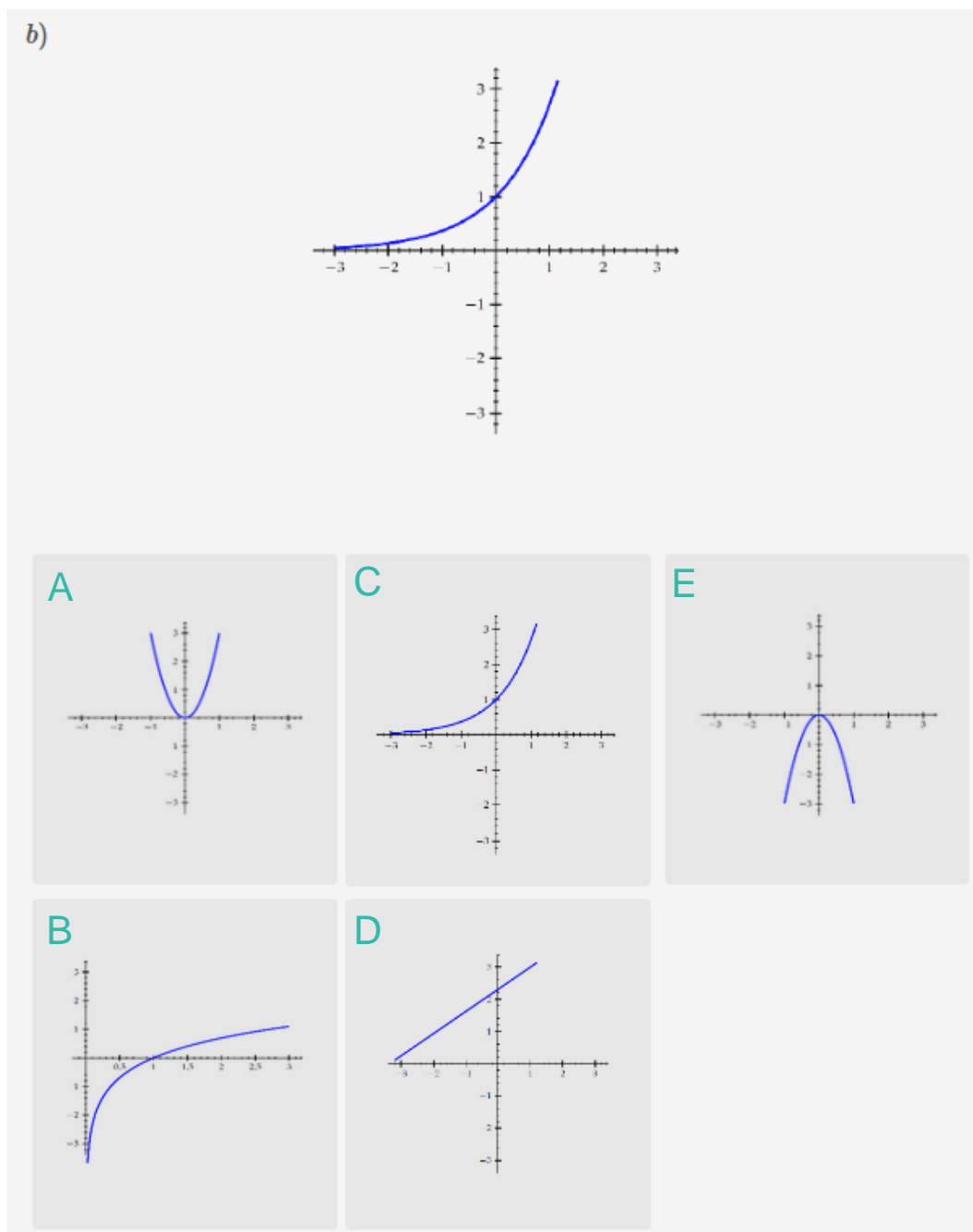

Math Problem ID

D4

Correct Answers and Answer Frequencies

Math Problem Part	Correct Answer	Number Correct Answers	Number Incorrect Answers ^a	Answer Frequencies				
				A	B	C	D	E
a)	blinded	blinded	blinded	blinded	blinded	blinded	blinded	blinded
b)	blinded	blinded	blinded	blinded	blinded	blinded	blinded	blinded

Note. Scoring (PCS4): Every correct response is worth one point (up to 2 points possible).

^a Includes cases, where the problem was seen but not answered.

Item Characteristics

Discrimination					
Measurement Type		Model A8	Model B	Model C	Model D
Correlation to participant ability (θ)		0.70	0.63	0.63	0.63
Discrimination Parameter (α)		1.62	1.38	1.27	1.59
Difficulty					
Measurement Type	Points	Model A8	Model B	Model C	Model D
Difficulty for participant of average ability level	2	-0.11	-0.03	-0.13	-0.04
	1	-1.18	-1.14	-1.34	-1.10
	0	NA	NA	NA	NA
Cumulative probability for participant of average ability level	2	55.4%	51.1%	54.8%	51.8%
	1	93.2%	89.7%	91.4%	91.5%
	0	100%	100%	100%	100%
Frequencies					
Groups	Points	Frequencies		Percent (%)	
Complete sample for this math problem (n = 544)	2	288		52.9%	
	1	162		29.8%	
	0	94		17.3%	
Female (n = 181)	2	77		42.5%	
	1	63		34.8%	
	0	41		22.7%	
Male (n = 356)	2	206		57.9%	
	1	97		27.2%	
	0	53		14.9%	
German as primary language at home (n = 418)	2	233		55.7%	
	1	118		28.2%	
	0	67		16.0%	
Other language as primary language at home (n = 125)	2	54		43.2%	
	1	44		35.2%	
	0	27		21.6%	
Secondary school completed in Germany (n = 495)	2	266		53.7%	
	1	146		29.5%	
	0	83		16.8%	
Secondary school completed abroad (n = 47)	2	21		44.7%	
	1	16		34.0%	
	0	10		21.3%	
Math not attended as advanced course in secondary school (n = 178)	2	54		30.3%	
	1	65		36.5%	
	0	59		33.1%	
Math attended as advanced course in secondary school (n = 323)	2	214		66.3%	
	1	82		25.4%	
	0	27		8.4%	

Frequencies			
Groups	Points	Frequencies	Percent (%)
No math preparatory course attended (n = 233)	2	85	36.5%
	1	84	36.1%
	0	64	27.5%
Math preparatory course attended (n = 306)	2	201	65.7%
	1	75	24.5%
	0	30	9.8%
University of applied sciences (n = 134)	2	41	30.6%
	1	52	38.8%
	0	41	30.6%
University (n = 410)	2	247	60.2%
	1	110	26.8%
	0	53	12.9%
Online Participation (n = 374)	2	187	50.0%
	1	115	30.7%
	0	72	19.3%
Pen-and-Paper Participation (n = 170)	2	101	59.4%
	1	47	27.6%
	0	22	12.9%
Attended Gymnasium (n = 413)	2	238	57.6%
	1	111	26.9%
	0	64	15.5%
Attended Other Secondary School (n = 118)	2	46	39.0%
	1	47	39.8%
	0	25	21.2%

Note. Due to missing values on demographics questions, frequencies within groups may not add up to the total number of responses.

Plots

All plots are generated from **Model A8**.

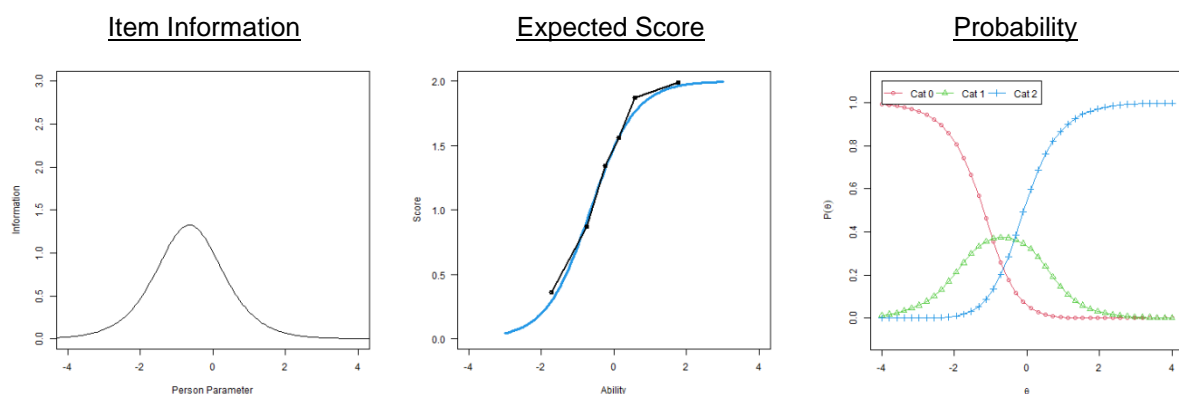

Note. The blue line represents expected performance, and the black line represents actual performance.

Note. Cat n = probability of receiving n points.

Differential Item Functioning (DIF)

This problem shows DIF based on attending a math preparatory course before starting postsecondary education. The difficulty parameter (β) was significantly lower for those who attended a preparatory course. Meanwhile, the discrimination parameter (α) was significantly higher for the same group. This shows that the problem was significantly easier and more informative for those who attended a math preparatory course.

Expected Score (math preparatory course attended)

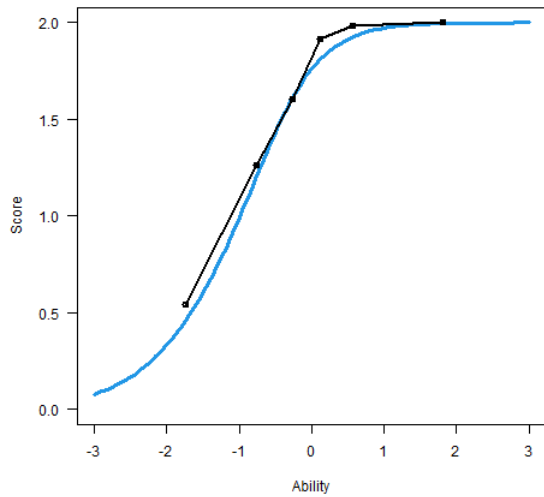

Expected Score (no math preparatory course attended)

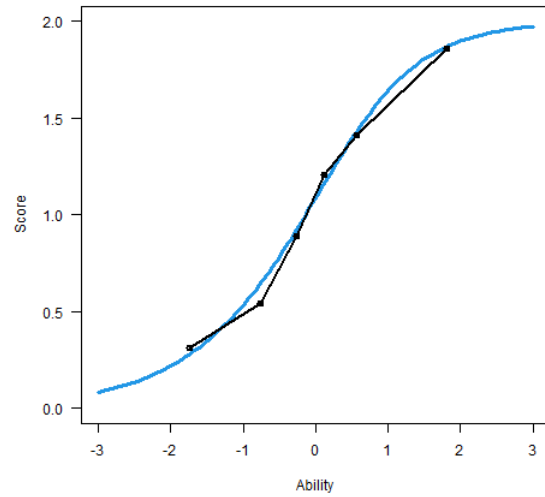

Note. The blue line represents expected performance, and the black line represents actual performance.

4.8.5. Tangent Slope (D5)

Tangentensteigung

In welchem der Punkte A , B , C oder D hat die Steigung des Graphen den niedrigsten Wert?

Wählen Sie die richtige Antwort.

A A

B B

C C

D D

Math Problem ID

D5

Correct Answers and Answer Frequencies

Correct Answer	Number Correct Answers	Number Incorrect Answers ^a	Answer Frequencies			
			A	B	C	D
blinded	blinded	blinded	blinded	blinded	blinded	blinded

Note. Scoring (PCS4): Every correct response is worth one point (up to 1 point possible).

^a Includes cases, where the problem was seen but not answered.

Item Characteristics

Discrimination					
Measurement Type		Model A8	Model B	Model C	Model D
Correlation to participant ability (θ)		0.34	0.34	0.34	0.33
Discrimination Parameter (α)		0.60	0.69	0.67	0.66
Difficulty					
Measurement Type	Points	Model A8	Model B	Model C	Model D
Difficulty for participant of average ability level	1	0.27	0.30	0.21	0.30
	0	NA	NA	NA	NA
Cumulative probability for participant of average ability level	1	46.0%	44.9%	46.5%	45.0%
	0	100%	100%	100%	100%
Frequencies					
Groups	Points	Frequencies		Percent (%)	
Complete sample for this math problem (n = 545)	1	254		46.6%	
	0	291		53.4%	
Female (n = 177)	1	72		40.7%	
	0	105		59.3%	
Male (n = 360)	1	179		49.7%	
	0	181		50.3%	
German as primary language at home (n = 411)	1	188		45.7%	
	0	223		54.3%	
Other language as primary language at home (n = 130)	1	64		49.2%	
	0	66		50.8%	
Secondary school completed in Germany (n = 483)	1	230		47.6%	
	0	253		52.4%	
Secondary school completed abroad (n = 59)	1	23		39.0%	
	0	36		61.0%	
Math not attended as advanced course in secondary school (n = 171)	1	60		35.1%	
	0	111		64.9%	
Math attended as advanced course in secondary school (n = 320)	1	169		52.8%	
	0	151		47.2%	
No math preparatory course attended (n = 240)	1	115		47.9%	
	0	125		52.1%	
Math preparatory course attended (n = 299)	1	136		45.5%	
	0	163		54.5%	
University of applied sciences (n = 137)	1	63		46.0%	
	0	74		54.0%	
University (n = 408)	1	191		46.8%	
	0	217		53.2%	
Online Participation (n = 377)	1	179		47.5%	
	0	198		52.5%	
Pen-and-Paper Participation (n = 168)	1	75		44.6%	
	0	93		55.4%	

Frequencies			
Groups	Points	Frequencies	Percent (%)
Attended Gymnasium (n = 404)	1	195	48.3%
	0	209	51.7%
Attended Other Secondary School (n = 126)	1	53	42.1%
	0	73	57.9%

Note. Due to missing values on demographics questions, frequencies within groups may not add up to the total number of responses.

Plots

All plots are generated from **Model A8**.

Item Information

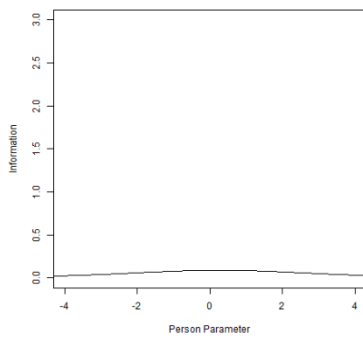

Expected Score

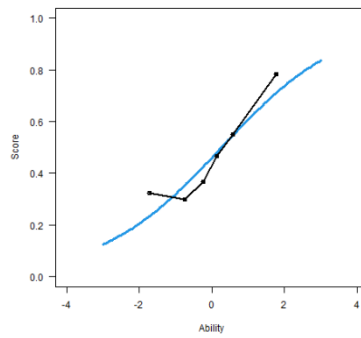

Probability

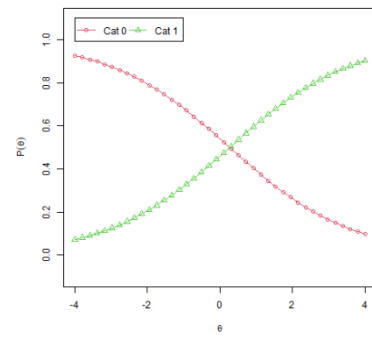

Note. The blue line represents expected performance, and the black line represents actual performance.

Note. Cat n = probability of receiving n points.

4.8.6. Tangent Equation (D6)

Tangentengleichung

Gegeben sei die Funktion f mit $f(x) = 3x^2 + 2$. Bestimmen Sie die Gleichung der Tangente an den Graphen f im Punkt $(1|5)$.

Ergänzen Sie die freien Felder.

Steigung der Tangente:

y-Achsenabschnitt der Tangente:

Math Problem ID

D6

Correct Answers and Answer Frequencies

Blank	Correct Answer(s)	Number Correct Answers	Number Incorrect Answers
1	blinded	blinded	blinded
2	blinded	blinded	blinded

Note. Scoring (PCS4): Every correct response is worth one point (up to 2 points possible).

Item Characteristics

Discrimination					
Measurement Type		Model A8	Model B	Model C	Model D
Correlation to participant ability (θ)		0.73	0.67	0.67	0.66
Discrimination Parameter (α)		1.67	1.28	1.19	1.52
Difficulty					
Measurement Type	Points	Model A8	Model B	Model C	Model D
Difficulty for participant of average ability level	2	0.28	0.40	0.34	0.37
	1	-0.20	-0.13	-0.24	-0.14
	0	NA	NA	NA	NA
Cumulative probability for participant of average ability level	2	33.0%	30.8%	34.7%	29.8%
	1	62.3%	56.5%	60.9%	57.6%
	0	100%	100%	100%	100%

Frequencies			
Groups	Points	Frequencies	Percent (%)
Complete sample for this math problem (n = 542)	2	219	40.4%
	1	99	18.3%
	0	224	41.3%
Female (n = 181)	2	63	34.8%
	1	33	18.2%
	0	85	47.0%
Male (n = 354)	2	152	42.9%
	1	66	18.6%
	0	136	38.4%
German as primary language at home (n = 418)	2	181	43.3%
	1	68	16.3%
	0	169	40.4%
Other language as primary language at home (n = 123)	2	38	30.9%
	1	31	25.2%
	0	54	43.9%
Secondary school completed in Germany (n = 494)	2	205	41.5%
	1	86	17.4%
	0	203	41.1%
Secondary school completed abroad (n = 46)	2	14	30.4%
	1	12	26.1%
	0	20	43.5%
Math not attended as advanced course in secondary school (n = 178)	2	31	17.4%
	1	28	15.7%
	0	119	66.9%
Math attended as advanced course in secondary school (n = 322)	2	173	53.7%
	1	61	18.9%
	0	88	27.3%
No math preparatory course attended (n = 231)	2	68	29.4%
	1	44	19.0%
	0	119	51.5%
Math preparatory course attended (n = 306)	2	150	49.0%
	1	52	17.0%
	0	104	34.0%
University of applied sciences (n = 134)	2	24	17.9%
	1	26	19.4%
	0	84	62.7%
University (n = 408)	2	195	47.8%
	1	73	17.9%
	0	140	34.3%
Online Participation (n = 372)	2	149	40.1%
	1	68	18.3%
	0	155	41.7%
Pen-and-Paper Participation (n = 170)	2	70	41.2%
	1	31	18.2%
	0	69	40.6%

Frequencies			
Groups	Points	Frequencies	Percent (%)
Attended Gymnasium (n = 411)	2	183	44.5%
	1	70	17.0%
	0	158	38.4%
Attended Other Secondary School (n = 118)	2	32	27.1%
	1	24	20.3%
	0	62	52.5%

Note. Due to missing values on demographics questions, frequencies within groups may not add up to the total number of responses.

Plots

All plots are generated from **Model A8**.

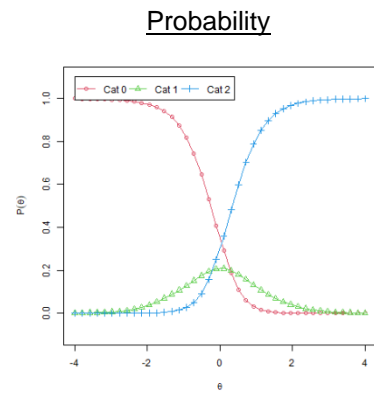
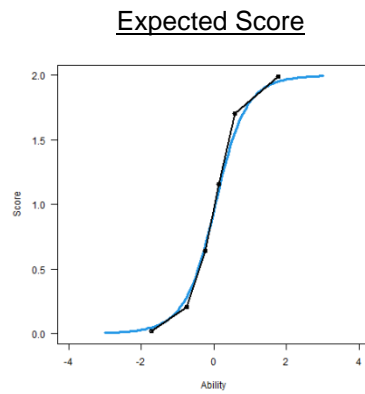
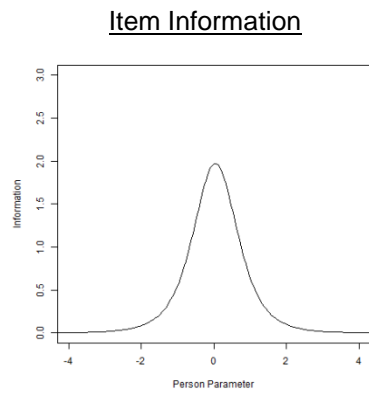

Note. The blue line represents expected performance, and the black line represents actual performance.

Note. Cat n = probability of receiving n points.

4.8.7. Curve Sketching (Extreme and Inflection Points) (D7)

Kurvendiskussion (Extrem- und Wendepunkt)

Im Folgenden sind die Graphen der ersten Ableitung f' und zweiten Ableitung f'' einer Funktion f abgebildet. Was lässt sich daraus über den Graphen G_f von f aussagen?

f' :

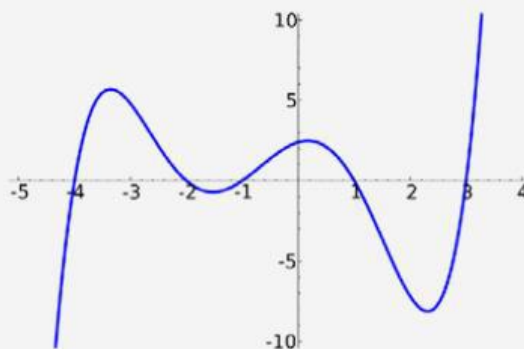

f'' :

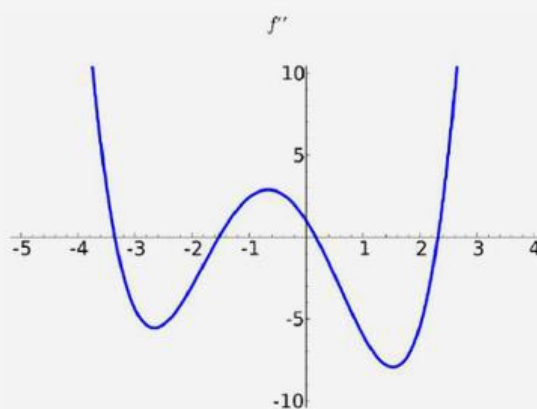

Wählen Sie eine oder mehrere Antworten.

G_f hat einen Tiefpunkt bei $x = 1$.

G_f hat einen Hochpunkt bei $x = 1$.

G_f hat einen Wendepunkt zwischen 1 und 2.

G_f hat einen Wendepunkt zwischen -2 und -1 .

Correct Answers and Answer Frequencies

Answer	Correct Answer(s)	Number Correct Answers	Number Incorrect Answers
G_f hat einen Tiefpunkt bei $x = 1$.	blinded	blinded	blinded
G_f hat einen Hochpunkt bei $x = 1$.	blinded	blinded	blinded
G_f hat einen Wendepunkt zwischen 1 und 2.	blinded	blinded	blinded
G_f hat einen Wendepunkt zwischen -2 und -1 .	blinded	blinded	blinded

Note. Scoring (PCS4): One point is earned for rejecting the first answer option and simultaneously choosing the second answer option. Another point is earned for rejecting the third answer option and simultaneously choosing the fourth answer option (up to 2 points possible).

Item Characteristics

Discrimination					
Measurement Type		Model A8	Model B	Model C	Model D
Correlation to participant ability (θ)		0.61	0.56	0.56	0.55
Discrimination Parameter (α)		1.09	0.96	0.93	1.07
Difficulty					
Measurement Type	Points	Model A8	Model B	Model C	Model D
Difficulty for participant of average ability level	2	0.18	0.25	0.16	0.23
	1	-1.10	-1.12	-1.28	-1.06
	0	NA	NA	NA	NA
Cumulative probability for participant of average ability level	2	43.8%	42.3%	45.3%	42.1%
	1	83.8%	81.8%	84.1%	82.6%
	0	100%	100%	100%	100%
Frequencies					
Groups	Points	Frequencies		Percent (%)	
Complete sample for this math problem (n = 545)	2	245		45.0%	
	1	178		32.7%	
	0	122		22.4%	
Female (n = 177)	2	69		39.0%	
	1	64		36.2%	
	0	44		24.9%	
Male (n = 360)	2	170		47.2%	
	1	113		31.4%	
	0	77		21.4%	
German as primary language at home (n = 411)	2	205		49.9%	
	1	120		29.2%	
	0	86		20.9%	
Other language as primary language at home (n = 130)	2	40		30.8%	
	1	55		42.3%	
	0	35		26.9%	

Frequencies			
Groups	Points	Frequencies	Percent (%)
Secondary school completed in Germany (n = 483)	2	232	48.0%
	1	151	31.3%
	0	100	20.7%
Secondary school completed abroad (n = 59)	2	13	22.0%
	1	26	44.1%
	0	20	33.9%
Math not attended as advanced course in secondary school (n = 171)	2	50	29.2%
	1	65	38.0%
	0	56	32.7%
Math attended as advanced course in secondary school (n = 320)	2	179	55.9%
	1	91	28.4%
	0	50	15.6%
No math preparatory course attended (n = 240)	2	84	35.0%
	1	87	36.3%
	0	69	28.8%
Math preparatory course attended (n = 299)	2	160	53.5%
	1	88	29.4%
	0	51	17.1%
University of applied sciences (n = 137)	2	32	23.4%
	1	52	38.0%
	0	53	38.7%
University (n = 408)	2	213	52.2%
	1	126	30.9%
	0	69	16.9%
Online Participation (n = 377)	2	174	46.2%
	1	113	30.0%
	0	90	23.9%
Pen-and-Paper Participation (n = 168)	2	71	42.3%
	1	65	38.7%
	0	32	19.0%
Attended Gymnasium (n = 404)	2	203	50.2%
	1	130	32.2%
	0	71	17.6%
Attended Other Secondary School (n = 126)	2	42	33.3%
	1	40	31.7%
	0	44	34.9%

Note. Due to missing values on demographics questions, frequencies within groups may not add up to the total number of responses.

Plots

All plots are generated from **Model A8**.

Item Information

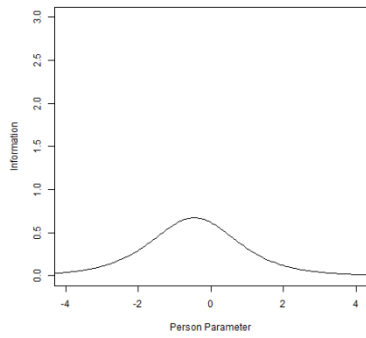

Expected Score

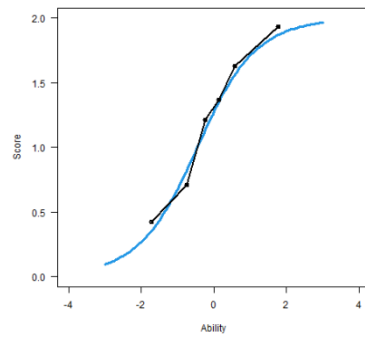

Probability

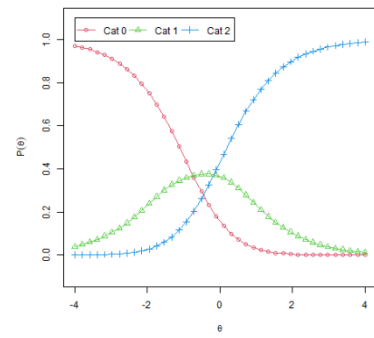

Note. The blue line represents expected performance, and the black line represents actual performance.

Note. Cat n = probability of receiving n points.

4.8.8. Extreme Points of Functions (D8)

Extrempunkte von Funktionsgraphen

Für die Tatsache, dass x_0 Extremstelle der Funktion $f : \mathbb{R} \rightarrow \mathbb{R}$ ist, ist...

Wählen Sie jeweils die richtige Antwort.

a)

$f''(x_0) < 0$

b)

$f'(x_0) = 0$ und $f''(x_0) \neq 0$

Math Problem ID

D8

Answer Options

Answer Code	Answer Text
A	notwendig, aber nicht hinreichend
B	hinreichend
C	nicht notwendig

Correct Answers and Answer Frequencies

Math Problem Part	Correct Answer	Number Correct Answers	Number Incorrect Answers ^a	Answer Frequencies		
				A	B	C
a)	blinded	blinded	blinded	blinded	blinded	blinded
b)	blinded	blinded	blinded	blinded	blinded	blinded

Note. Scoring (PCS4): Every correct response is worth one point (up to 2 points possible).

^a Includes cases, where the problem was seen but not answered.

Item Characteristics

Discrimination					
Measurement Type		Model A8	Model B	Model C	Model D
Correlation to participant ability (θ)		0.47	0.42	0.42	0.44
Discrimination Parameter (α)		0.57	0.55	0.53	0.58
Difficulty					
Measurement Type	Points	Model A8	Model B	Model C	Model D
Difficulty for participant of average ability level	2	0.97	1.05	0.99	1.00
	1	-0.66	-0.62	-0.74	-0.59
	0	NA	NA	NA	NA
Cumulative probability for participant of average ability level	2	30.9%	30.0%	31.6%	29.9%
	1	63.1%	62.0%	63.9%	62.1%
	0	100%	100%	100%	100%
Frequencies					
Groups	Points	Frequencies		Percent (%)	
Complete sample for this math problem (n = 544)	2	180		33.1%	
	1	160		29.4%	
	0	204		37.5%	
Female (n = 177)	2	60		33.9%	
	1	53		29.9%	
	0	64		36.2%	
Male (n = 359)	2	115		32.0%	
	1	107		29.8%	
	0	137		38.2%	
German as primary language at home (n = 411)	2	142		34.5%	
	1	120		29.2%	
	0	149		36.3%	
Other language as primary language at home (n = 129)	2	36		27.9%	
	1	39		30.2%	
	0	54		41.9%	
Secondary school completed in Germany (n = 482)	2	165		34.2%	
	1	135		28.0%	
	0	182		37.8%	
Secondary school completed abroad (n = 59)	2	14		23.7%	
	1	24		40.7%	
	0	21		35.6%	
Math not attended as advanced course in secondary school (n = 171)	2	36		21.1%	
	1	57		33.3%	
	0	78		45.6%	
Math attended as advanced course in secondary school (n = 320)	2	127		39.7%	
	1	87		27.2%	
	0	106		33.1%	

Frequencies			
Groups	Points	Frequencies	Percent (%)
No math preparatory course attended (n = 240)	2	71	29.6%
	1	69	28.8%
	0	100	41.7%
Math preparatory course attended (n = 298)	2	107	35.9%
	1	91	30.5%
	0	100	33.6%
University of applied sciences (n = 136)	2	27	19.9%
	1	41	30.1%
	0	68	50.0%
University (n = 408)	2	153	37.5%
	1	119	29.2%
	0	136	33.3%
Online Participation (n = 376)	2	122	32.4%
	1	106	28.2%
	0	148	39.4%
Pen-and-Paper Participation (n = 168)	2	58	34.5%
	1	54	32.1%
	0	56	33.3%
Attended Gymnasium (n = 404)	2	148	36.6%
	1	119	29.5%
	0	137	33.9%
Attended Other Secondary School (n = 125)	2	30	24.0%
	1	37	29.6%
	0	58	46.4%

Note. Due to missing values on demographics questions, frequencies within groups may not add up to the total number of responses.

Plots

All plots are generated from **Model A8**.

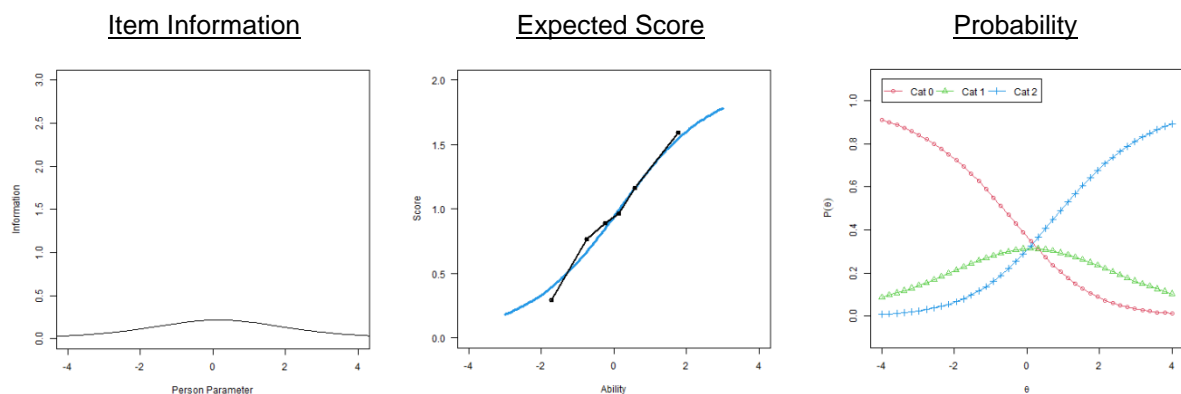

Note. The blue line represents expected performance, and the black line represents actual performance.

Note. Cat n = probability of receiving n points.

4.8.9. Difference Quotient (D9)

Differenzenquotient

Welche der folgenden Terme ist der Differenzenquotient?

Wählen Sie die richtige Antwort.

$$\frac{f(x_0 + h) - f(x_0)}{x_0 + h}$$
A

$$\frac{f(x_0 + h) + f(x_0)}{h}$$
B

$$\frac{f(x_0 + h) - f(x_0)}{h}$$
C

$$\frac{f(x_0 - h) - f(x_0 + h)}{h}$$
D

Math Problem ID

D9

Changes to the Problem After the Main Study

This problem was changed after the main study. The reason for the implemented changes and results of qualitative interviews testing the revised version are reported in **Section 5**.

Correct Answers and Answer Frequencies

Correct Answer	Number Correct Answers	Number Incorrect Answers ^a	Answer Frequencies			
			A	B	C	D
blinded	blinded	blinded	blinded	blinded	blinded	blinded

Note. Scoring (PCS4): Every correct response is worth one point (up to 1 point possible).

^a Includes cases, where the problem was seen but not answered.

Item Characteristics

Discrimination					
Measurement Type		Model A8	Model B	Model C	Model D
Correlation to participant ability (θ)		0.54	0.52	0.52	0.52
Discrimination Parameter (α)		1.34	1.34	1.22	1.40
Difficulty					
Measurement Type	Points	Model A8	Model B	Model C	Model D
Difficulty for participant of average ability level	1	-0.19	-0.08	-0.19	-0.10
	0	NA	NA	NA	NA
Cumulative probability for participant of average ability level	1	56.4%	52.8%	55.8%	53.5%
	0	100%	100%	100%	100%
Frequencies					
Groups	Points	Frequencies		Percent (%)	
Complete sample for this math problem (n = 552)	1	305		55.3%	
	0	247		44.7%	
Female (n = 184)	1	97		52.7%	
	0	87		47.3%	
Male (n = 361)	1	202		56.0%	
	0	159		44.0%	
German as primary language at home (n = 424)	1	225		53.1%	
	0	199		46.9%	
Other language as primary language at home (n = 127)	1	79		62.2%	
	0	48		37.8%	
Secondary school completed in Germany (n = 503)	1	271		53.9%	
	0	232		46.1%	
Secondary school completed abroad (n = 47)	1	33		70.2%	
	0	14		29.8%	
Math not attended as advanced course in secondary school (n = 181)	1	60		33.1%	
	0	121		66.9%	
Math attended as advanced course in secondary school (n = 327)	1	215		65.7%	
	0	112		34.3%	
No math preparatory course attended (n = 237)	1	110		46.4%	
	0	127		53.6%	
Math preparatory course attended (n = 309)	1	189		61.2%	
	0	120		38.8%	
University of applied sciences (n = 135)	1	52		38.5%	
	0	83		61.5%	
University (n = 417)	1	253		60.7%	
	0	164		39.3%	
Online Participation (n = 382)	1	214		56.0%	
	0	168		44.0%	
Pen-and-Paper Participation (n = 170)	1	91		53.5%	
	0	79		46.5%	

Frequencies			
Groups	Points	Frequencies	Percent (%)
Attended Gymnasium (n = 420)	1	231	55.0%
	0	189	45.0%
Attended Other Secondary School (n = 119)	1	64	53.8%
	0	55	46.2%

Note. Due to missing values on demographics questions, frequencies within groups may not add up to the total number of responses.

Plots

All plots are generated from **Model A8**.

Item Information

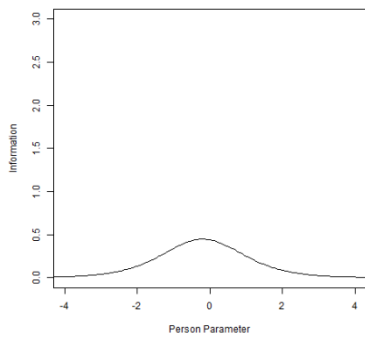

Expected Score

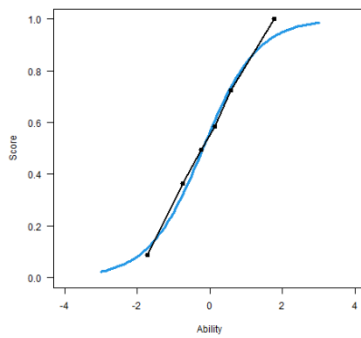

Probability

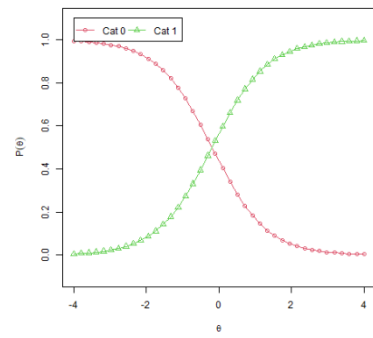

Note. The blue line represents expected performance, and the black line represents actual performance.

Note. Cat n = probability of receiving n points.

4.8.10. Average Slopes (D10)

Durchschnittliche Steigungen

Gegeben ist eine Funktion f mit folgendem Graphen:

Innerhalb welchen Intervalls ist die durchschnittliche Steigung von f am größten?

Wählen Sie die richtige Antwort.

A [1, 3] **B** [3, 5] **C** [5, 6]

Math Problem ID

D10

Correct Answers and Answer Frequencies

Correct Answer	Number Correct Answers	Number Incorrect Answers ^a	Answer Frequencies		
			A	B	C
blinded	blinded	blinded	blinded	blinded	blinded

Note. Scoring (PCS4): Every correct response is worth one point (up to 1 point possible).

^a Includes cases, where the problem was seen but not answered.

Item Characteristics

Discrimination					
Measurement Type		Model A8	Model B	Model C	Model D
Correlation to participant ability (θ)		0.31	0.29	0.29	0.30
Discrimination Parameter (α)		0.90	1.06	0.95	1.04
Difficulty					
Measurement Type	Points	Model A8	Model B	Model C	Model D
Difficulty for participant of average ability level	1	-2.82	-2.43	-2.72	-2.49
	0	NA	NA	NA	NA
Cumulative probability for participant of average ability level	1	92.7%	93.0%	93.0%	92.9%
	0	100%	100%	100%	100%
Frequencies					
Groups	Points	Frequencies		Percent (%)	
Complete sample for this math problem (n = 547)	1	495		90.5%	
	0	52		9.5%	
Female (n = 177)	1	156		88.1%	
	0	21		11.9%	
Male (n = 362)	1	331		91.4%	
	0	31		8.6%	
German as primary language at home (n = 412)	1	386		93.7%	
	0	26		6.3%	
Other language as primary language at home (n = 131)	1	105		80.2%	
	0	26		19.8%	
Secondary school completed in Germany (n = 485)	1	445		91.8%	
	0	40		8.2%	
Secondary school completed abroad (n = 59)	1	47		79.7%	
	0	12		20.3%	
Math not attended as advanced course in secondary school (n = 171)	1	150		87.7%	
	0	21		12.3%	
Math attended as advanced course in secondary school (n = 321)	1	300		93.5%	
	0	21		6.5%	
No math preparatory course attended (n = 241)	1	206		85.5%	
	0	35		14.5%	
Math preparatory course attended (n = 300)	1	284		94.7%	
	0	16		5.3%	
University of applied sciences (n = 138)	1	122		88.4%	
	0	16		11.6%	
University (n = 409)	1	373		91.2%	
	0	36		8.8%	
Online Participation (n = 379)	1	344		90.8%	
	0	35		9.2%	
Pen-and-Paper Participation (n = 168)	1	151		89.9%	
	0	17		10.1%	

Frequencies			
Groups	Points	Frequencies	Percent (%)
Attended Gymnasium (n = 406)	1	377	92.9%
	0	29	7.1%
Attended Other Secondary School (n = 126)	1	109	86.5%
	0	17	13.5%

Note. Due to missing values on demographics questions, frequencies within groups may not add up to the total number of responses.

Plots

All plots are generated from **Model A8**.

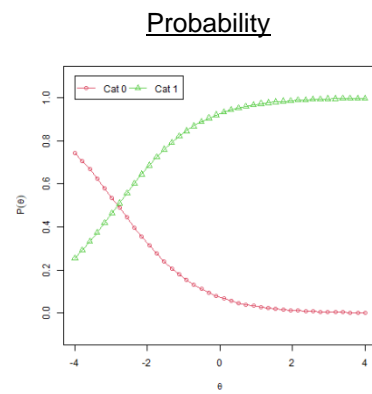
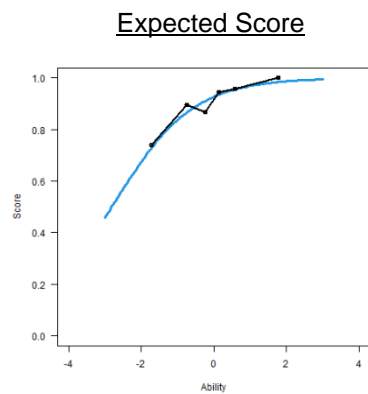
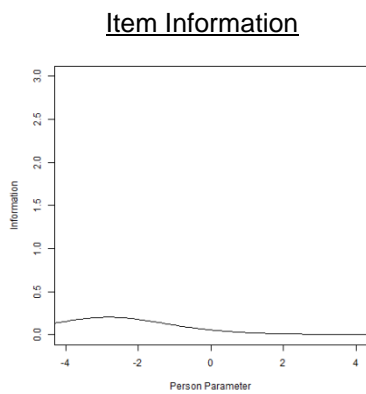

Note. The blue line represents expected performance, and the black line represents actual performance.

Note. Cat n = probability of receiving n points.

4.8.11. Statements About Derivatives (D11)

Aussagen zur Ableitung

Welche der folgenden Aussagen sind wahr?

Wählen Sie eine oder mehrere richtige Antworten.

Die Ableitung einer Geraden ist immer konstant.

Eine Funktion f mit $f'(x) = f(x)$ existiert nicht.

Leitet man eine beliebige Funktion oft genug ab, erhält man die Nullfunktion.

Die Ableitung eines Polynoms ist wieder ein Polynom oder die Nullfunktion.

Math Problem ID

D11

Correct Answers and Answer Frequencies

Answer	Correct Answer(s)	Number Correct Answers	Number Incorrect Answers
Die Ableitung einer Geraden ist immer konstant.	blinded	blinded	blinded
Eine Funktion f mit $f'(x) = f(x)$ existiert nicht.	blinded	blinded	blinded
Leitet man eine beliebige Funktion oft genug ab, erhält man die Nullfunktion.	blinded	blinded	blinded
Die Ableitung eines Polynoms ist wieder ein Polynom oder die Nullfunktion.	blinded	blinded	blinded

Note. Scoring (PCS4): One point is earned for correctly choosing Answer Options 1 and 4, respectively. One point is earned for simultaneously rejecting Answer Options 2 and 3 (up to 3 points possible).

Item Characteristics

Discrimination					
Measurement Type		Model A8	Model B	Model C	Model D
Correlation to participant ability (θ)		0.57	0.51	0.51	0.51
Discrimination Parameter (α)		0.66	0.63	0.63	0.66
Difficulty					
Measurement Type	Points	Model A8	Model B	Model C	Model D
Difficulty for participant of average ability level	3	1.07	1.20	1.16	1.15
	2	-0.50	-0.40	-0.51	-0.41
	1	-2.46	-2.41	-2.77	-2.35
	0	NA	NA	NA	NA
Cumulative probability for participant of average ability level	3	26.2%	24.4%	25.7%	24.5%
	2	62.9%	60.2%	62.5%	60.8%
	1	92.5%	91.3%	93.3%	91.7%
	0	100%	100%	100%	100%
Frequencies					
Groups	Points	Frequencies		Percent (%)	
Complete sample for this math problem (n = 548)	3	160		29.2%	
	2	175		31.9%	
	1	154		28.1%	
	0	59		10.8%	
Female (n = 183)	3	46		25.1%	
	2	57		31.1%	
	1	57		31.1%	
	0	23		12.6%	
Male (n = 358)	3	111		31.0%	
	2	117		32.7%	
	1	95		26.5%	
	0	35		9.8%	
German as primary language at home (n = 422)	3	133		31.5%	
	2	136		32.2%	
	1	110		26.1%	
	0	43		10.2%	
Other language as primary language at home (n = 125)	3	27		21.6%	
	2	39		31.2%	
	1	43		34.4%	
	0	16		12.8%	
Secondary school completed in Germany (n = 499)	3	150		30.1%	
	2	160		32.1%	
	1	137		27.5%	
	0	52		10.4%	

Frequencies			
Groups	Points	Frequencies	Percent (%)
Secondary school completed abroad (n = 47)	3	10	21.3%
	2	15	31.9%
	1	15	31.9%
	0	7	14.9%
Math not attended as advanced course in secondary school (n = 179)	3	36	20.1%
	2	52	29.1%
	1	59	33.0%
	0	32	17.9%
Math attended as advanced course in secondary school (n = 326)	3	113	34.7%
	2	108	33.1%
	1	84	25.8%
	0	21	6.4%
No math preparatory course attended (n = 236)	3	55	23.3%
	2	78	33.1%
	1	71	30.1%
	0	32	13.6%
Math preparatory course attended (n = 307)	3	103	33.6%
	2	95	30.9%
	1	82	26.7%
	0	27	8.8%
University of applied sciences (n = 134)	3	27	20.1%
	2	43	32.1%
	1	40	29.9%
	0	24	17.9%
University (n = 414)	3	133	32.1%
	2	132	31.9%
	1	114	27.5%
	0	35	8.5%
Online Participation (n = 378)	3	112	29.6%
	2	128	33.9%
	1	101	26.7%
	0	37	9.8%
Pen-and-Paper Participation (n = 170)	3	48	28.2%
	2	47	27.6%
	1	53	31.2%
	0	22	12.9%
Attended Gymnasium (n = 417)	3	128	30.7%
	2	143	34.3%
	1	102	24.5%
	0	44	10.6%
Attended Other Secondary School (n = 118)	3	30	25.4%
	2	27	22.9%
	1	47	39.8%
	0	14	11.9%

Note. Due to missing values on demographics questions, frequencies within groups may not add up to the total number of responses.

Plots

All plots are generated from **Model A8**.

Item Information

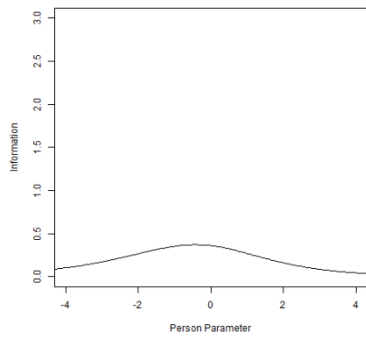

Expected Score

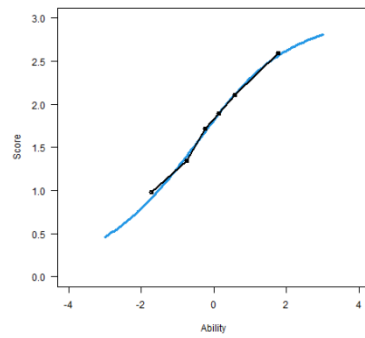

Probability

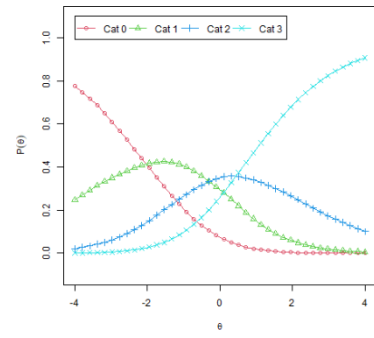

Note. The blue line represents expected performance, and the black line represents actual performance.

Note. Cat n = probability of receiving n points.

4.9. Integral Calculus (Integralrechnung; I)

Q₃ Statistics for Integral Calculus

	I1	I2	I3	I4	I5	I6	I7	I8	I9	I10
I1	-									
I2	-.110	-								
I3	-.065	-.112	-							
I4	-.002	-.115	-.203	-						
I5	.179	.069	-.242	.432	-					
I6	-.015	-.104	-.121	.113	.291	-				
I7	.034	-.169	-.185	.130	.252	.103	-			
I8	.067	.042	-.278	.278	.572	.184	.174	-		
I9	-.038	-.118	-.080	.083	.275	.006	.073	.176	-	
I10	-.204	-.100	.046	-.332	-.386	-.220	-.127	-.311	-.282	-

Note. Q₃ statistics above the critical absolute value of 0.20 are bolded. For details see **Section 3.1**.

4.9.1. Main Theorem of Differential and Integral Calculus (I1)

Hauptsatz der Differential- und Integralrechnung

Gegeben sei eine differenzierbare Funktion f mit der Stammfunktion F . Welche der untenstehenden Terme stimmen mit dem Term überein?

$$\int f'(x) \, dx =$$

Wählen Sie eine oder mehrere richtige Antworten.

$F(x)$

$f(x)$

$f''(x)$

$F'(x)$

Math Problem ID

I1

Correct Answers and Answer Frequencies

Answer	Correct Answer(s)	Number Correct Answers	Number Incorrect Answers
$F(x)$	blinded	blinded	blinded
$f(x)$	blinded	blinded	blinded
$f''(x)$	blinded	blinded	blinded
$F'(x)$	blinded	blinded	blinded

Note. Scoring (PCS4): One point is earned for rejecting the first answer option and simultaneously choosing the fourth answer option. Another point is earned for rejecting the third answer option and simultaneously choosing the fourth answer option (up to 2 points possible).

Item Characteristics

Discrimination					
Measurement Type		Model A9	Model B	Model C	Model D
Correlation to participant ability (θ)		0.67	0.59	0.57	0.57
Discrimination Parameter (α)		1.35	1.19	0.82	1.27
Difficulty					
Measurement Type	Points	Model A9	Model B	Model C	Model D
Difficulty for participant of average ability level	2	1.10	1.16	1.39	1.12
	1	-1.11	-1.21	-1.68	-1.17
	0	NA	NA	NA	NA
Cumulative probability for participant of average ability level	2	16.2%	17.6%	21.5%	17.1%
	1	84.1%	83.5%	83.1%	83.9%
	0	100%	100%	100%	100%

Frequencies			
Groups	Points	Frequencies	Percent (%)
Complete sample for this math problem (n = 530)	2	129	24.3%
	1	286	54.0%
	0	115	21.7%
Female (n = 183)	2	37	20.2%
	1	109	59.6%
	0	37	20.2%
Male (n = 339)	2	90	26.5%
	1	173	51.0%
	0	76	22.4%
German as primary language at home (n = 399)	2	111	27.8%
	1	210	52.6%
	0	78	19.5%
Other language as primary language at home (n = 131)	2	18	13.7%
	1	76	58.0%
	0	37	28.2%
Secondary school completed in Germany (n = 469)	2	120	25.6%
	1	246	52.5%
	0	103	22.0%
Secondary school completed abroad (n = 60)	2	9	15.0%
	1	39	65.0%
	0	12	20.0%
Math not attended as advanced course in secondary school (n = 180)	2	19	10.6%
	1	88	48.9%
	0	73	40.6%
Math attended as advanced course in secondary school (n = 309)	2	102	33.0%
	1	173	56.0%
	0	34	11.0%
No math preparatory course attended (n = 234)	2	41	17.5%
	1	131	56.0%
	0	62	26.5%
Math preparatory course attended (n = 289)	2	88	30.4%
	1	150	51.9%
	0	51	17.6%
University of applied sciences (n = 133)	2	20	15.0%
	1	62	46.6%
	0	51	38.3%
University (n = 397)	2	109	27.5%
	1	224	56.4%
	0	64	16.1%
Online Participation (n = 367)	2	89	24.3%
	1	192	52.3%
	0	86	23.4%
Pen-and-Paper Participation (n = 163)	2	40	24.5%
	1	94	57.7%
	0	29	17.8%

Frequencies			
Groups	Points	Frequencies	Percent (%)
Attended Gymnasium (n = 402)	2	109	27.1%
	1	224	55.7%
	0	69	17.2%
Attended Other Secondary School (n = 122)	2	19	15.6%
	1	58	47.5%
	0	45	36.9%

Note. Due to missing values on demographics questions, frequencies within groups may not add up to the total number of responses.

Plots

All plots are generated from **Model A9**.

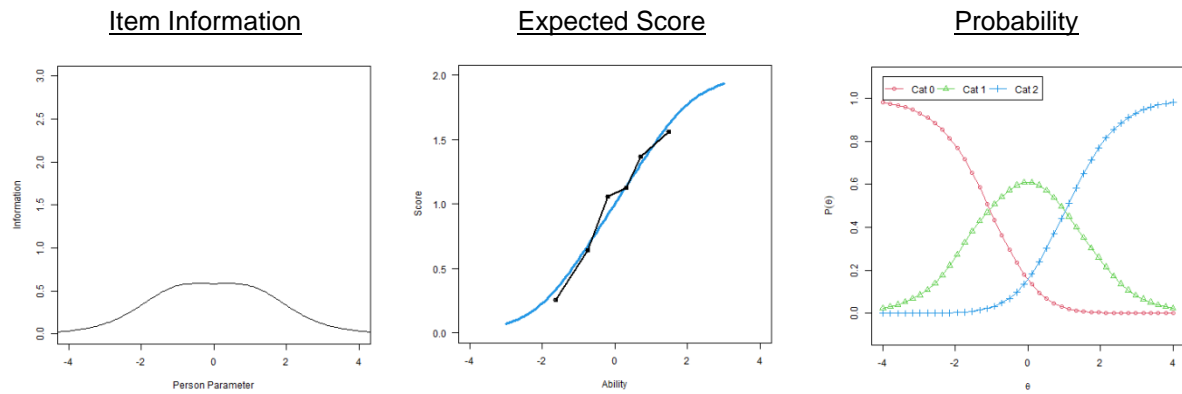

Note. The blue line represents expected performance, and the black line represents actual performance.

Note. Cat n = probability of receiving n points.

4.9.2. Antiderivative of Known Functions (I2)

Stammfunktionen bekannter Funktionen

Geben Sie jeweils eine Stammfunktion F_i von f_i an.

Ergänzen Sie die freien Felder.

Beachten Sie: Eingabe besonderer Funktionen: $\sin()$ (Sinus), $\cos()$ (Kosinus), $\ln()$ (Logarithmus).

Schreibweise:
 Nutzen Sie folgende Zeichen: + (Addition), - (Subtraktion), * (Multiplikation), / (Division), ^ (Potenz).

$f_1(x) = x^2$	$F_1(x) =$	<input style="width: 90%;" type="text"/>
$f_2(x) = \cos(x)$	$F_2(x) =$	<input style="width: 90%;" type="text"/>
$f_3(x) = \frac{1}{x}$	$F_3(x) =$	<input style="width: 90%;" type="text"/>

Math Problem ID

I2

Correct Answers and Answer Frequencies

Blank	Correct Answer(s)	Number Correct Answers	Number Incorrect Answers
1	blinded	blinded	blinded
2	blinded	blinded	blinded
3	blinded	blinded	blinded

Note. Scoring (PCS4): Every correct response is worth one point (up to 3 points possible).

Item Characteristics

Discrimination					
Measurement Type		Model A9	Model B	Model C	Model D
Correlation to participant ability (θ)		0.75	0.69	0.64	0.66
Discrimination Parameter (α)		1.16	1.03	0.73	1.12
Difficulty					
Measurement Type	Points	Model A9	Model B	Model C	Model D
Difficulty for participant of average ability level	3	0.64	0.67	0.71	0.64
	2	-0.42	-0.45	-0.64	-0.44
	1	-1.18	-1.23	-1.66	-1.20
	0	NA	NA	NA	NA
Cumulative probability for participant of average ability level	3	26.5%	27.5%	31.7%	27.0%
	2	69.4%	68.8%	69.7%	69.5%
	1	91.2%	90.1%	89.9%	91.0%
	0	100%	100%	100%	100%
Frequencies					
Groups	Points	Frequencies	Percent (%)		
Complete sample for this math problem (n = 544)	3	173	31.8%		
	2	167	30.7%		
	1	102	18.8%		
	0	102	18.8%		
Female (n = 178)	3	54	30.3%		
	2	55	30.9%		
	1	36	20.2%		
	0	33	18.5%		
Male (n = 357)	3	118	33.1%		
	2	111	31.1%		
	1	65	18.2%		
	0	63	17.6%		
German as primary language at home (n = 401)	3	129	32.2%		
	2	125	31.2%		
	1	80	20.0%		
	0	67	16.7%		
Other language as primary language at home (n = 143)	3	44	30.8%		
	2	42	29.4%		
	1	22	15.4%		
	0	35	24.5%		
Secondary school completed in Germany (n = 480)	3	152	31.7%		
	2	146	30.4%		
	1	94	19.6%		
	0	88	18.3%		

Frequencies			
Groups	Points	Frequencies	Percent (%)
Secondary school completed abroad (n = 63)	3	21	33.3%
	2	20	31.7%
	1	8	12.7%
	0	14	22.2%
Math not attended as advanced course in secondary school (n = 184)	3	29	15.8%
	2	41	22.3%
	1	40	21.7%
	0	74	40.2%
Math attended as advanced course in secondary school (n = 319)	3	129	40.4%
	2	114	35.7%
	1	56	17.6%
	0	20	6.3%
No math preparatory course attended (n = 254)	3	72	28.3%
	2	69	27.2%
	1	54	21.3%
	0	59	23.2%
Math preparatory course attended (n = 284)	3	99	34.9%
	2	95	33.5%
	1	48	16.9%
	0	42	14.8%
University of applied sciences (n = 135)	3	26	19.3%
	2	27	20.0%
	1	25	18.5%
	0	57	42.2%
University (n = 409)	3	147	35.9%
	2	140	34.2%
	1	77	18.8%
	0	45	11.0%
Online Participation (n = 390)	3	128	32.8%
	2	116	29.7%
	1	64	16.4%
	0	82	21.0%
Pen-and-Paper Participation (n = 154)	3	45	29.2%
	2	51	33.1%
	1	38	24.7%
	0	20	13.0%
Attended Gymnasium (n = 403)	3	136	33.7%
	2	132	32.8%
	1	79	19.6%
	0	56	13.9%
Attended Other Secondary School (n = 135)	3	35	25.9%
	2	33	24.4%
	1	23	17.0%
	0	44	32.6%

Note. Due to missing values on demographics questions, frequencies within groups may not add up to the total number of responses.

Plots

All plots are generated from **Model A9**.

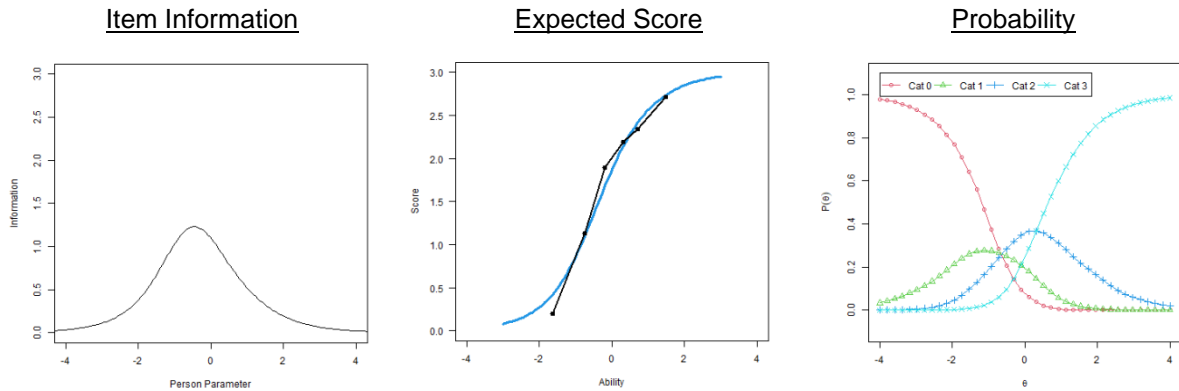

Note. The blue line represents expected performance, and the black line represents actual performance.

Note. Cat n = probability of receiving n points.

Differential Item Functioning (DIF)

This problem shows DIF based on attending math as an advanced or regular course in high school. The difficulty (β) and discrimination (α) parameters were significantly lower for those who attended math as an advanced course. This shows that the problem was significantly easier and less informative for those who attended math as an advanced course in high school.

Expected Score (math attended as advanced course in high school)

Expected Score (math not attended as advanced course in high school)

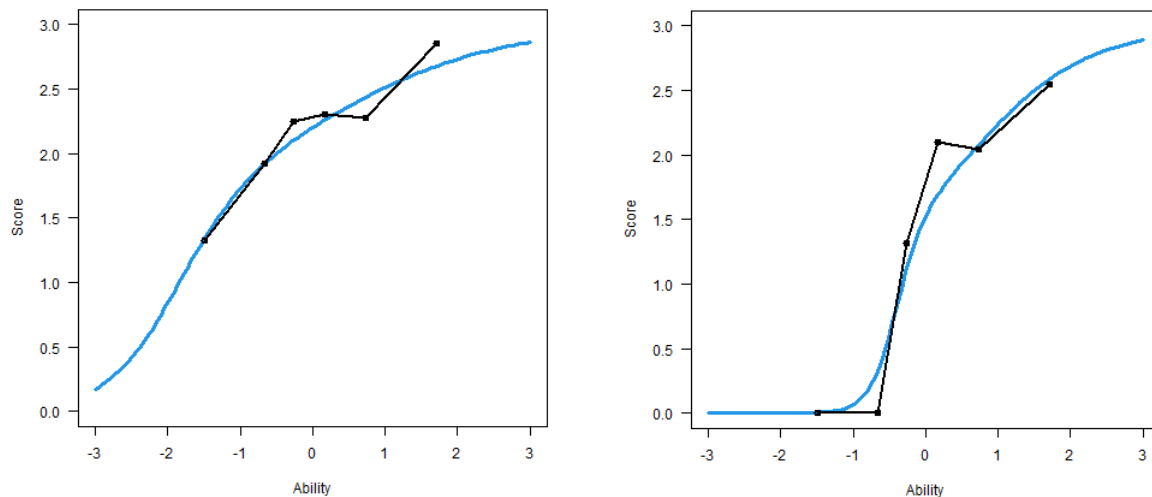

Note. The blue line represents expected performance, and the black line represents actual performance.

This problem also shows DIF based on the attendance of a university compared to a university of applied sciences. The discrimination (α) was significantly lower for those who attended a university. This shows the problem was significantly less informative for those who were attending a university.

Expected Score (university of applied sciences)

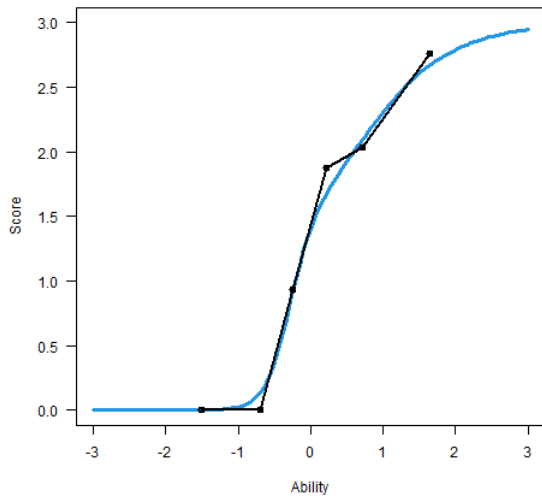

Expected Score (university)

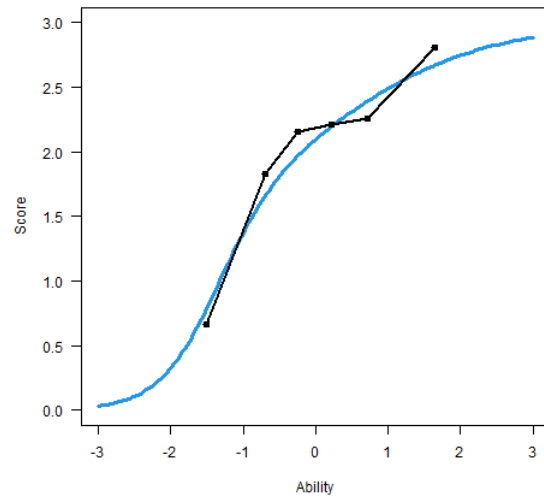

Note. The blue line represents expected performance, and the black line represents actual performance.

4.9.3. Graphs and Antiderivatives (I3)

Graphen und Stammfunktionen

Die folgenden beiden Abbildungen zeigen die Graphen zweier Ableitungsfunktionen.

Wählen Sie für jeden Funktionsgraphen eine mögliche Stammfunktion aus.

a)

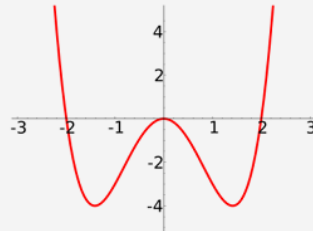

$F(x) = -x^3 + 2x^2 + c, \quad c \in \mathbb{R}$

A

$G(x) = \frac{1}{5}x^5 - \frac{4}{3}x^3 + c, \quad c \in \mathbb{R}$

B

$H(x) = -\frac{1}{4}x^4 + \frac{2}{3}x^3 + c, \quad c \in \mathbb{R}$

C

$I(x) = \frac{1}{4}x^4 - \frac{1}{4}x^2 + c, \quad c \in \mathbb{R}$

D

b)

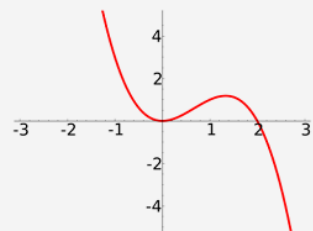

$F(x) = -x^3 + 2x^2 + c, \quad c \in \mathbb{R}$

A

$G(x) = \frac{1}{5}x^5 - \frac{4}{3}x^3 + c, \quad c \in \mathbb{R}$

B

$H(x) = -\frac{1}{4}x^4 + \frac{2}{3}x^3 + c, \quad c \in \mathbb{R}$

C

$I(x) = \frac{1}{4}x^4 - \frac{1}{4}x^2 + c, \quad c \in \mathbb{R}$

D

Correct Answers and Answer Frequencies

Math Problem Part	Correct Answer	Number Correct Answers	Number Incorrect Answers ^a	Answer Frequencies			
				A	B	C	D
a)	blinded	blinded	blinded	blinded	blinded	blinded	blinded
b)	blinded	blinded	blinded	blinded	blinded	blinded	blinded

Note. Scoring (PCS4): Every correct response is worth one point (up to 2 points possible).

^a Includes cases, where the problem was seen but not answered.

Item Characteristics

Discrimination					
Measurement Type		Model A9	Model B	Model C	Model D
Correlation to participant ability (θ)		0.53	0.49	0.46	0.45
Discrimination Parameter (α)		0.74	0.68	0.45	0.71
Difficulty					
Measurement Type	Points	Model A9	Model B	Model C	Model D
Difficulty for participant of average ability level	2	0.95	1.00	1.27	0.97
	1	0.13	0.14	0.06	0.13
	0	NA	NA	NA	NA
Cumulative probability for participant of average ability level	2	24.3%	24.7%	28.1%	24.6%
	1	46.2%	46.4%	48.8%	46.4%
	0	100%	100%	100%	100%
Frequencies					
Groups	Points	Frequencies		Percent (%)	
Complete sample for this math problem (n = 536)	2	154		28.7%	
	1	103		19.2%	
	0	279		52.1%	
Female (n = 176)	2	44		25.0%	
	1	30		17.0%	
	0	102		58.0%	
Male (n = 352)	2	109		31.0%	
	1	71		20.2%	
	0	172		48.9%	
German as primary language at home (n = 397)	2	127		32.0%	
	1	73		18.4%	
	0	197		49.6%	
Other language as primary language at home (n = 139)	2	27		19.4%	
	1	30		21.6%	
	0	82		59.0%	
Secondary school completed in Germany (n = 473)	2	136		28.8%	
	1	92		19.5%	
	0	245		51.8%	

Frequencies			
Groups	Points	Frequencies	Percent (%)
Secondary school completed abroad (n = 62)	2	17	27.4%
	1	11	17.7%
	0	34	54.8%
Math not attended as advanced course in secondary school (n = 181)	2	30	16.6%
	1	32	17.7%
	0	119	65.7%
Math attended as advanced course in secondary school (n = 314)	2	111	35.4%
	1	65	20.7%
	0	138	43.9%
No math preparatory course attended (n = 249)	2	50	20.1%
	1	47	18.9%
	0	152	61.0%
Math preparatory course attended (n = 281)	2	101	35.9%
	1	56	19.9%
	0	124	44.1%
University of applied sciences (n = 134)	2	22	16.4%
	1	24	17.9%
	0	88	65.7%
University (n = 402)	2	132	32.8%
	1	79	19.7%
	0	191	47.5%
Online Participation (n = 382)	2	101	26.4%
	1	72	18.8%
	0	209	54.7%
Pen-and-Paper Participation (n = 154)	2	53	34.4%
	1	31	20.1%
	0	70	45.5%
Attended Gymnasium (n = 396)	2	125	31.6%
	1	74	18.7%
	0	197	49.7%
Attended Other Secondary School (n = 134)	2	29	21.6%
	1	28	20.9%
	0	77	57.5%

Note. Due to missing values on demographics questions, frequencies within groups may not add up to the total number of responses.

Plots

All plots are generated from **Model A9**.

Item Information

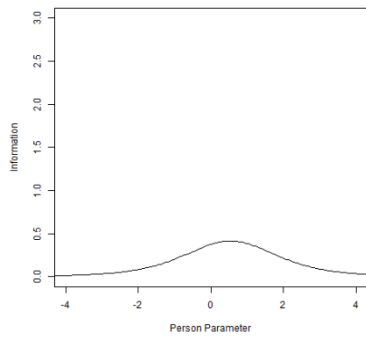

Expected Score

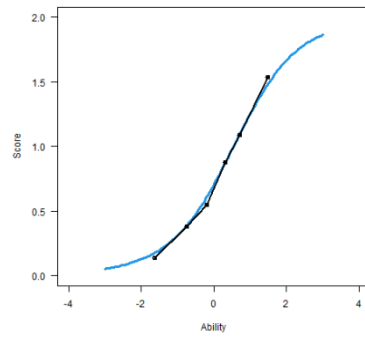

Probability

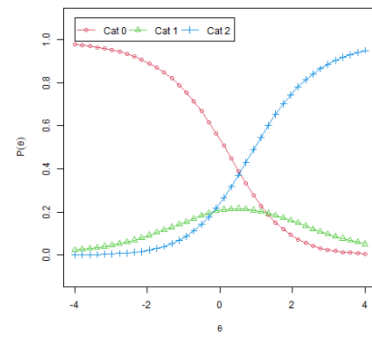

Note. The blue line represents expected performance, and the black line represents actual performance.

Note. Cat n = probability of receiving n points.

4.9.4. Integration Bounds (I4)

Integrationsgrenzen

Wie ist die Grenze a zu wählen, damit die Gleichung erfüllt wird?

Wählen Sie die richtige Antwort.

$$\int_a^3 x^2 dx = 18$$

-3 ▾

Math Problem ID

I4

Answer Options

Answer Code	Answer Text
A	-3
B	-2
C	-1
D	2
E	3

Correct Answers and Answer Frequencies

Correct Answer	Number Correct Answers	Number Incorrect Answers ^a	Answer Frequencies				
			A	B	C	D	E
blinded	blinded	blinded	blinded	blinded	blinded	blinded	blinded

Note. Scoring (PCS4): Every correct response is worth one point (up to 1 point possible).

^a Includes cases, where the problem was seen but not answered.

Item Characteristics

Discrimination					
Measurement Type		Model A9	Model B	Model C	Model D
Correlation to participant ability (θ)		0.63	0.56	0.53	0.53
Discrimination Parameter (α)		1.84	1.62	1.18	1.72
Difficulty					
Measurement Type	Points	Model A9	Model B	Model C	Model D
Difficulty for participant of average ability level	1	-0.63	-0.70	-0.97	-0.67
	0	NA	NA	NA	NA
Cumulative probability for participant of average ability level	1	76.0%	75.6%	75.9%	76.1%
	0	100%	100%	100%	100%

Frequencies			
Groups	Points	Frequencies	Percent (%)
Complete sample for this math problem (n = 537)	1	372	69.3%
	0	165	30.7%
Female (n = 184)	1	123	66.8%
	0	61	33.2%
Male (n = 345)	1	245	71.0%
	0	100	29.0%
German as primary language at home (n = 404)	1	280	69.2%
	0	124	30.8%
Other language as primary language at home (n = 133)	1	92	69.2%
	0	41	30.8%
Secondary school completed in Germany (n = 476)	1	322	67.6%
	0	154	32.4%
Secondary school completed abroad (n = 60)	1	49	81.7%
	0	11	18.3%
Math not attended as advanced course in secondary school (n = 182)	1	87	47.8%
	0	95	52.2%
Math attended as advanced course in secondary school (n = 314)	1	257	81.8%
	0	57	18.2%
No math preparatory course attended (n = 240)	1	155	64.6%
	0	85	35.4%
Math preparatory course attended (n = 290)	1	212	73.1%
	0	78	26.9%
University of applied sciences (n = 134)	1	67	50.0%
	0	67	50.0%
University (n = 403)	1	305	75.7%
	0	98	24.3%
Online Participation (n = 372)	1	247	66.4%
	0	125	33.6%
Pen-and-Paper Participation (n = 165)	1	125	75.8%
	0	40	24.2%
Attended Gymnasium (n = 407)	1	300	73.7%
	0	107	26.3%
Attended Other Secondary School (n = 124)	1	68	54.8%
	0	56	45.2%

Note. Due to missing values on demographics questions, frequencies within groups may not add up to the total number of responses.

Plots

All plots are generated from **Model A9**.

Item Information

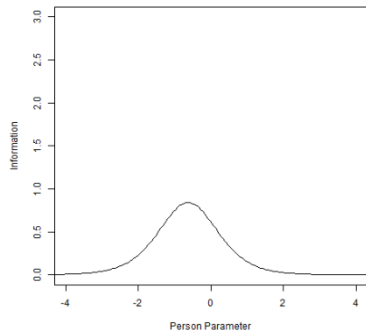

Expected Score

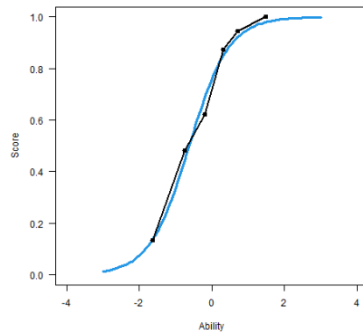

Probability

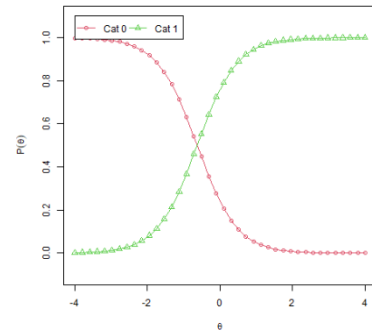

Note. The blue line represents expected performance, and the black line represents actual performance.

Note. Cat n = probability of receiving n points.

4.9.5. Areas (I5)

Flächeninhalte

Berechnen Sie den Inhalt der markierten Fläche. Geben Sie Ihr Ergebnis als vollständig gekürzten Bruch an.

Ergänzen Sie das freie Feld.

Beachten Sie: Nutzen Sie zum Ausdruck von Brüchen das Zeichen / (Division).

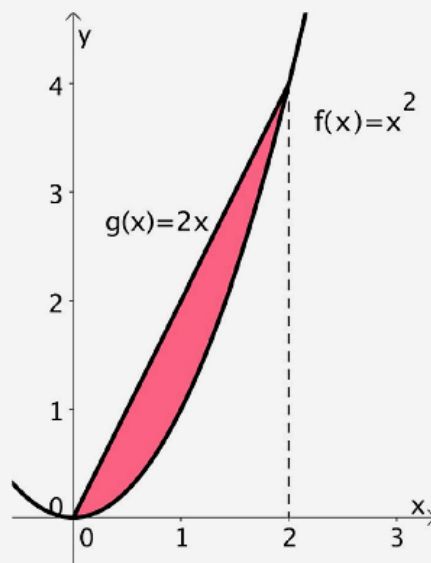

Der Flächeninhalt beträgt:

Math Problem ID

I5

Correct Answers and Answer Frequencies

Correct Answer(s)	Number Correct Answers	Number Incorrect Answers
blinded	blinded	blinded

Note. Scoring (PCS4): Every correct response is worth one point (up to 1 point possible).

Item Characteristics

Discrimination					
Measurement Type		Model A9	Model B	Model C	Model D
Correlation to participant ability (θ)		0.73	0.71	0.70	0.69
Discrimination Parameter (α)		2.94	2.77	2.25	2.97
Difficulty					
Measurement Type	Points	Model A9	Model B	Model C	Model D
Difficulty for participant of average ability level	1	0.11	0.10	0.00	0.10
	0	NA	NA	NA	NA
Cumulative probability for participant of average ability level	1	42.1%	43.2%	50.1%	42.6%
	0	100%	100%	100%	100%
Frequencies					
Groups	Points	Frequencies		Percent (%)	
Complete sample for this math problem (n = 541)	1	255		47.1%	
	0	286		52.9%	
Female (n = 176)	1	77		43.8%	
	0	99		56.3%	
Male (n = 357)	1	177		49.6%	
	0	180		50.4%	
German as primary language at home (n = 400)	1	188		47.0%	
	0	212		53.0%	
Other language as primary language at home (n = 141)	1	67		47.5%	
	0	74		52.5%	
Secondary school completed in Germany (n = 478)	1	217		45.4%	
	0	261		54.6%	
Secondary school completed abroad (n = 62)	1	38		61.3%	
	0	24		38.7%	
Math not attended as advanced course in secondary school (n = 182)	1	40		22.0%	
	0	142		78.0%	
Math attended as advanced course in secondary school (n = 318)	1	194		61.0%	
	0	124		39.0%	
No math preparatory course attended (n = 251)	1	92		36.7%	
	0	159		63.3%	
Math preparatory course attended (n = 284)	1	162		57.0%	
	0	122		43.0%	
University of applied sciences (n = 135)	1	29		21.5%	
	0	106		78.5%	
University (n = 406)	1	226		55.7%	
	0	180		44.3%	
Online Participation (n = 387)	1	183		47.3%	
	0	204		52.7%	
Pen-and-Paper Participation (n = 154)	1	72		46.8%	
	0	82		53.2%	

Frequencies			
Groups	Points	Frequencies	Percent (%)
Attended Gymnasium (n = 400)	1	210	52.5%
	0	190	47.5%
Attended Other Secondary School (n = 135)	1	42	31.1%
	0	93	68.9%

Note. Due to missing values on demographics questions, frequencies within groups may not add up to the total number of responses.

Plots

All plots are generated from **Model A9**.

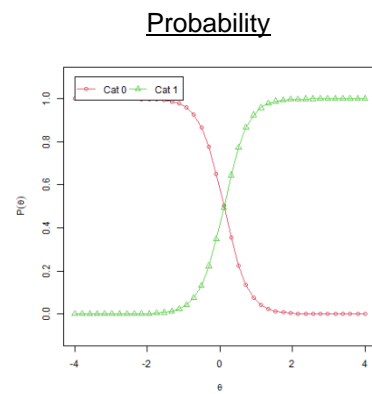
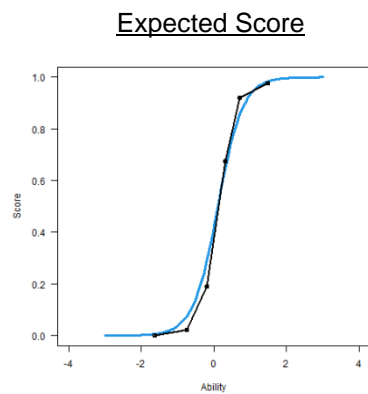
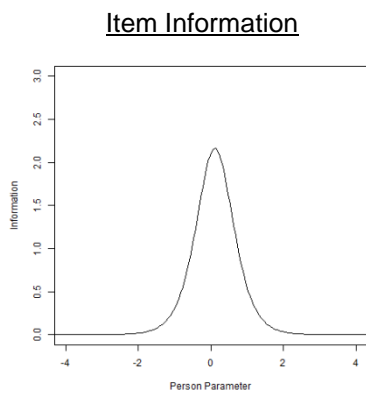

Note. The blue line represents expected performance, and the black line represents actual performance.

Note. Cat n = probability of receiving n points.

4.9.6. Totals and Integrals (I6)

Gesamtbestand und Integrale

Betrachten Sie die Abbildung. Was wird durch den Inhalt der markierten Fläche beschrieben?

Wählen Sie die richtige Antwort.

- Die zurückgelegte Strecke im Zeitraum von 3 bis 15 Sekunden. A
- Die Geschwindigkeit im Zeitraum von 3 bis 15 Sekunden. B
- Die Beschleunigung im Zeitraum von 3 bis 15 Sekunden. C
- Das Höhenprofil der Wegstrecke im Zeitraum von 3 bis 15 Sekunden. D

Math Problem ID

I6

Correct Answers and Answer Frequencies

Correct Answer	Number Correct Answers	Number Incorrect Answers ^a	Answer Frequencies			
			A	B	C	D
blinded	blinded	blinded	blinded	blinded	blinded	blinded

Note. Scoring (PCS4): Every correct response is worth one point (up to 1 point possible).

^a Includes cases, where the problem was seen but not answered.

Item Characteristics

Discrimination					
Measurement Type		Model A9	Model B	Model C	Model D
Correlation to participant ability (θ)		0.61	0.59	0.57	0.56
Discrimination Parameter (α)		1.63	1.64	1.29	1.67
Difficulty					
Measurement Type	Points	Model A9	Model B	Model C	Model D
Difficulty for participant of average ability level	1	-0.36	-0.39	-0.57	-0.38
	0	NA	NA	NA	NA
Cumulative probability for participant of average ability level	1	64.4%	65.5%	67.6%	65.4%
	0	100%	100%	100%	100%
Frequencies					
Groups	Points	Frequencies		Percent (%)	
Complete sample for this math problem (n = 542)	1	333		61.4%	
	0	209		38.6%	
Female (n = 187)	1	91		48.7%	
	0	96		51.3%	
Male (n = 346)	1	239		69.1%	
	0	107		30.9%	
German as primary language at home (n = 407)	1	266		65.4%	
	0	141		34.6%	
Other language as primary language at home (n = 135)	1	67		49.6%	
	0	68		50.4%	
Secondary school completed in Germany (n = 481)	1	294		61.1%	
	0	187		38.9%	
Secondary school completed abroad (n = 60)	1	38		63.3%	
	0	22		36.7%	
Math not attended as advanced course in secondary school (n = 185)	1	68		36.8%	
	0	117		63.2%	
Math attended as advanced course in secondary school (n = 315)	1	241		76.5%	
	0	74		23.5%	
No math preparatory course attended (n = 242)	1	135		55.8%	
	0	107		44.2%	
Math preparatory course attended (n = 293)	1	195		66.6%	
	0	98		33.4%	
University of applied sciences (n = 136)	1	65		47.8%	
	0	71		52.2%	
University (n = 406)	1	268		66.0%	
	0	138		34.0%	
Online Participation (n = 376)	1	224		59.6%	
	0	152		40.4%	
Pen-and-Paper Participation (n = 166)	1	109		65.7%	
	0	57		34.3%	

Frequencies			
Groups	Points	Frequencies	Percent (%)
Attended Gymnasium (n = 409)	1	277	67.7%
	0	132	32.3%
Attended Other Secondary School (n = 127)	1	53	41.7%
	0	74	58.3%

Note. Due to missing values on demographics questions, frequencies within groups may not add up to the total number of responses.

Plots

All plots are generated from **Model A9**.

Item Information

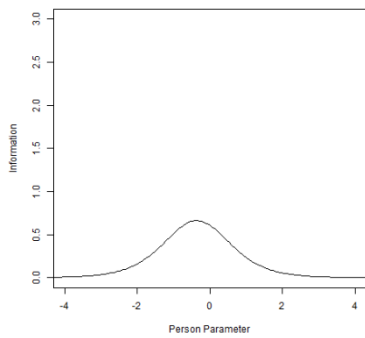

Expected Score

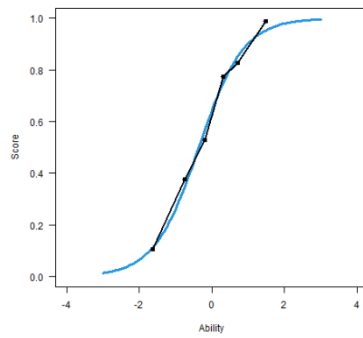

Probability

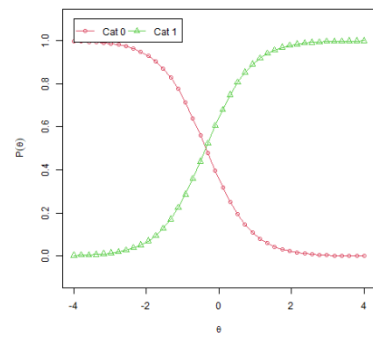

Note. The blue line represents expected performance, and the black line represents actual performance.

Note. Cat n = probability of receiving n points.

4.9.7. Oriented Areas and Interval Additivity (I7)

Orientierte Flächeninhalte und Intervalladditivität

Bestimmen Sie den Wert der Integrale mithilfe der in der Abbildung angegebenen Flächeninhalte A, B, C .

Ergänzen Sie die freien Felder.

$$\int_b^d f(x) \, dx = \text{[]}$$

$$\int_c^b f(x) \, dx = \text{[]}$$

Math Problem ID

I7

Correct Answers and Answer Frequencies

Blank	Correct Answer(s)	Number Correct Answers	Number Incorrect Answers
1	blinded	blinded	blinded
2	blinded	blinded	blinded

Note. Scoring (PCS4): Every correct response is worth one point (up to 2 points possible).

Item Characteristics

Discrimination					
Measurement Type		Model A9	Model B	Model C	Model D
Correlation to participant ability (θ)		0.66	0.63	0.60	0.58
Discrimination Parameter (α)		1.57	1.38	0.93	1.50
Difficulty					
Measurement Type	Points	Model A9	Model B	Model C	Model D
Difficulty for participant of average ability level	2	1.27	1.34	1.55	1.29
	1	0.55	0.57	0.59	0.55
	0	NA	NA	NA	NA
Cumulative probability for participant of average ability level	2	4.3%	5.2%	9.3%	4.6%
	1	25.6%	26.9%	32.3%	26.2%
	0	100%	100%	100%	100%
Frequencies					
Groups	Points	Frequencies	Percent (%)		
Complete sample for this math problem (n = 533)	2	80	15.0%		
	1	109	20.5%		
	0	344	64.5%		
Female (n = 176)	2	14	8.0%		
	1	35	19.9%		
	0	127	72.2%		
Male (n = 349)	2	66	18.9%		
	1	74	21.2%		
	0	209	59.9%		
German as primary language at home (n = 395)	2	63	15.9%		
	1	90	22.8%		
	0	242	61.3%		
Other language as primary language at home (n = 138)	2	17	12.3%		
	1	19	13.8%		
	0	102	73.9%		
Secondary school completed in Germany (n = 471)	2	69	14.6%		
	1	91	19.3%		
	0	311	66.0%		
Secondary school completed abroad (n = 61)	2	11	18.0%		
	1	17	27.9%		
	0	33	54.1%		
Math not attended as advanced course in secondary school (n = 179)	2	8	4.5%		
	1	22	12.3%		
	0	149	83.2%		
Math attended as advanced course in secondary school (n = 314)	2	65	20.7%		
	1	77	24.5%		
	0	172	54.8%		

Frequencies			
Groups	Points	Frequencies	Percent (%)
No math preparatory course attended (n = 247)	2	21	8.5%
	1	36	14.6%
	0	190	76.9%
Math preparatory course attended (n = 280)	2	58	20.7%
	1	71	25.4%
	0	151	53.9%
University of applied sciences (n = 134)	2	4	3.0%
	1	14	10.4%
	0	116	86.6%
University (n = 399)	2	76	19.0%
	1	95	23.8%
	0	228	57.1%
Online Participation (n = 379)	2	54	14.2%
	1	72	19.0%
	0	253	66.8%
Pen-and-Paper Participation (n = 154)	2	26	16.9%
	1	37	24.0%
	0	91	59.1%
Attended Gymnasium (n = 394)	2	67	17.0%
	1	94	23.9%
	0	233	59.1%
Attended Other Secondary School (n = 133)	2	13	9.8%
	1	15	11.3%
	0	105	78.9%

Note. Due to missing values on demographics questions, frequencies within groups may not add up to the total number of responses.

Plots

All plots are generated from **Model A9**.

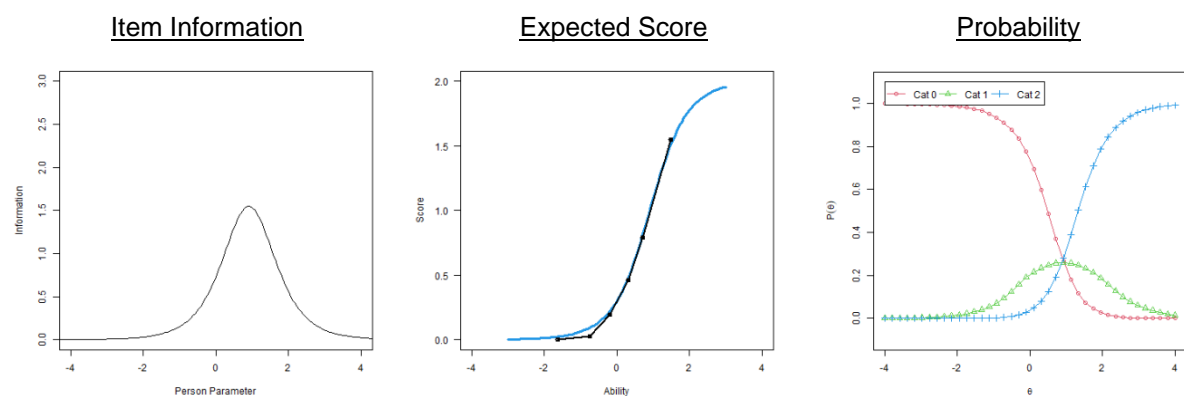

Note. The blue line represents expected performance, and the black line represents actual performance.

Note. Cat n = probability of receiving n points.

4.9.8. “Area – Indefinite?” (I8)

„Flächeninhalt – unbegrenzt?“

Bestimmen Sie das folgende Integral in Abhängigkeit des Parameters a .

Ergänzen Sie das freie Feld.

Schreibweise:
Nutzen Sie folgende Zeichen: + (Addition), - (Subtraktion), * (Multiplikation), / (Division), ^ (Potenz).

a)

$$\int_1^a x^{-2} dx = \text{[]}$$

b)

Je größer a wird, desto näher kommt das Integral dem Wert **1**. Welche Interpretation dieses mathematischen Sachverhalts trifft zu?

Wählen Sie eine oder mehrere richtige Antworten.

Ein solches Integral kann nicht als Flächeninhalt interpretiert werden.

Es handelt sich um ein sogenanntes uneigentliches Integral.

Der Wert beschreibt den Flächeninhalt bis zur Nullstelle der Funktion.

Der Flächeninhalt beträgt insgesamt nur **1**, auch wenn die beschriebene Fläche für a gegen unendlich kein Ende nimmt.

Note. This problem was changed during the final revision of the scoring rules, resulting in the removal of Part b). The reason for the change and an overview of the psychometric properties of the problem using the previous scoring rules can be found in **Appendix 8.1**.

Math Problem ID

I8

Correct Answers and Answer Frequencies

Math Problem Part	Correct Answer(s)	Number Correct Answers	Number Incorrect Answers
a)	blinded	blinded	blinded

Note. Scoring (PCS4): Every correct response is worth one point (up to 1 point possible). Part b) is cut.

Item Characteristics

Discrimination					
Measurement Type		Model A9	Model B	Model C	Model D
Correlation to participant ability (θ)		0.63	0.62	0.61	0.60
Discrimination Parameter (α)		2.29	2.28	1.64	2.40
Difficulty					
Measurement Type	Points	Model A9	Model B	Model C	Model D
Difficulty for participant of average ability level	1	0.85	0.84	0.90	0.83
	0	NA	NA	NA	NA
Cumulative probability for participant of average ability level	1	12.6%	12.9%	18.6%	12.1%
	0	100%	100%	100%	100%
Frequencies					
Groups	Points	Frequencies		Percent (%)	
Complete sample for this math problem (n = 533)	1	142		26.6%	
	0	391		73.4%	
Female (n = 184)	1	41		22.3%	
	0	143		77.7%	
Male (n = 341)	1	99		29.0%	
	0	242		71.0%	
German as primary language at home (n = 401)	1	113		28.2%	
	0	288		71.8%	
Other language as primary language at home (n = 132)	1	29		22.0%	
	0	103		78.0%	
Secondary school completed in Germany (n = 472)	1	117		24.8%	
	0	355		75.2%	
Secondary school completed abroad (n = 60)	1	24		40.0%	
	0	36		60.0%	
Math not attended as advanced course in secondary school (n = 182)	1	19		10.4%	
	0	163		89.6%	
Math attended as advanced course in secondary school (n = 310)	1	113		36.5%	
	0	197		63.5%	
No math preparatory course attended (n = 236)	1	51		21.6%	
	0	185		78.4%	
Math preparatory course attended (n = 290)	1	89		30.7%	
	0	201		69.3%	
University of applied sciences (n = 134)	1	17		12.7%	
	0	117		87.3%	
University (n = 399)	1	125		31.3%	
	0	274		68.7%	
Online Participation (n = 369)	1	96		26.0%	
	0	273		74.0%	
Pen-and-Paper Participation (n = 164)	1	46		28.0%	
	0	118		72.0%	

Frequencies			
Groups	Points	Frequencies	Percent (%)
Attended Gymnasium (n = 404)	1	122	30.2%
	0	282	69.8%
Attended Other Secondary School (n = 123)	1	18	14.6%
	0	105	85.4%

Note. Due to missing values on demographics questions, frequencies within groups may not add up to the total number of responses.

Plots

All plots are generated from **Model A9**.

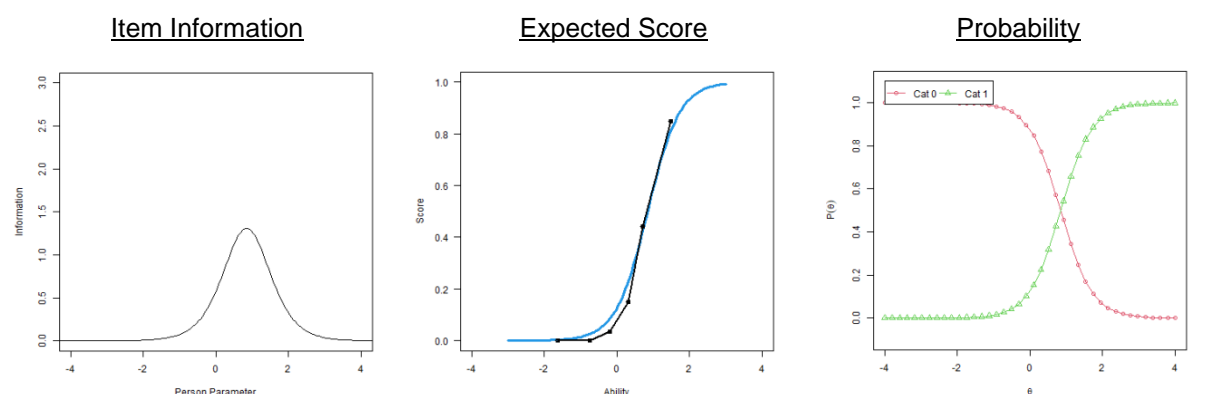

Note. The blue line represents expected performance, and the black line represents actual performance.

Note. Cat n = probability of receiving n points.

4.9.9. Integrations of a Monomial (I9)

Integration eines Monoms

Welcher der folgenden Terme vervollständigt die rechte Seite korrekt?

$$\int x^n dx = \dots$$

Wählen Sie die richtige Antwort.

A $\frac{1}{n}x^{n+1} + c$

B $\frac{1}{n+1}x^{n+1} + c$

C $nx^{x+1} + c$

D $(n+1)x^{n+1} + c$

Math Problem ID

I9

Changes to the Problem After the Main Study

This problem was changed after the main study. The reason for the implemented changes and results of qualitative interviews testing the revised version are reported in **Section 5**.

Correct Answers and Answer Frequencies

Correct Answer	Number Correct Answers	Number Incorrect Answers ^a	Answer Frequencies			
			A	B	C	D
blinded	blinded	blinded	blinded	blinded	blinded	blinded

Note. Scoring (PCS4): Every correct response is worth one point (up to 1 point possible).

^a Includes cases, where the problem was seen but not answered.

Item Characteristics

Discrimination					
Measurement Type		Model A9	Model B	Model C	Model D
Correlation to participant ability (θ)		0.61	0.56	0.54	0.55
Discrimination Parameter (α)		1.59	1.51	1.18	1.59
Difficulty					
Measurement Type	Points	Model A9	Model B	Model C	Model D
Difficulty for participant of average ability level	1	-0.34	-0.35	-0.52	-0.35
	0	NA	NA	NA	NA
Cumulative probability for participant of average ability level	1	63.0%	63.0%	64.8%	63.3%
	0	100%	100%	100%	100%

Frequencies			
Groups	Points	Frequencies	Percent (%)
Complete sample for this math problem (n = 547)	1	323	59.0%
	0	224	41.0%
Female (n = 178)	1	103	57.9%
	0	75	42.1%
Male (n = 360)	1	214	59.4%
	0	146	40.6%
German as primary language at home (n = 404)	1	236	58.4%
	0	168	41.6%
Other language as primary language at home (n = 143)	1	87	60.8%
	0	56	39.2%
Secondary school completed in Germany (n = 483)	1	278	57.6%
	0	205	42.4%
Secondary school completed abroad (n = 63)	1	44	69.8%
	0	19	30.2%
Math not attended as advanced course in secondary school (n = 186)	1	72	38.7%
	0	114	61.3%
Math attended as advanced course in secondary school (n = 320)	1	225	70.3%
	0	95	29.7%
No math preparatory course attended (n = 256)	1	130	50.8%
	0	126	49.2%
Math preparatory course attended (n = 285)	1	189	66.3%
	0	96	33.7%
University of applied sciences (n = 135)	1	54	40.0%
	0	81	60.0%
University (n = 412)	1	269	65.3%
	0	143	34.7%
Online Participation (n = 393)	1	222	56.5%
	0	171	43.5%
Pen-and-Paper Participation (n = 154)	1	101	65.6%
	0	53	34.4%
Attended Gymnasium (n = 406)	1	246	60.6%
	0	160	39.4%
Attended Other Secondary School (n = 135)	1	73	54.1%
	0	62	45.9%

Note. Due to missing values on demographics questions, frequencies within groups may not add up to the total number of responses.

Plots

All plots are generated from **Model A9**.

Item Information

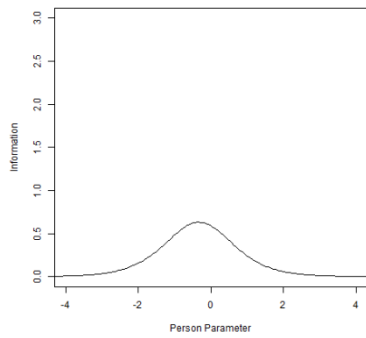

Expected Score

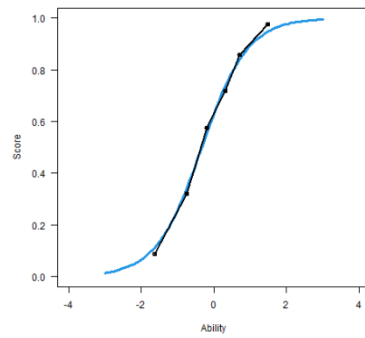

Note. The blue line represents expected performance, and the black line represents actual performance.

Probability

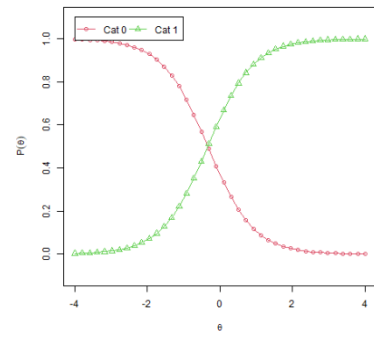

Note. Cat n = probability of receiving n points.

4.9.10. Antiderivative (I10)

Stammfunktion

Gegeben ist eine Funktion $f(x)$ mit Stammfunktion $F(x)$. Welche der folgenden Terme sind ebenfalls Stammfunktionen von $f(x)$?

Wählen Sie eine oder mehrere richtige Antworten.

$F(x) \cdot 2$

$F(x) + 3$

$F(x) - x$

$F(x) - 4$

Math Problem ID

I10

Correct Answers and Answer Frequencies

Answer	Correct Answer(s)	Number Correct Answers	Number Incorrect Answers
$F(x) \cdot 2$	blinded	blinded	blinded
$F(x) + 3$	blinded	blinded	blinded
$F(x) - x$	blinded	blinded	blinded
$F(x) - 4$	blinded	blinded	blinded

Note. Scoring (PCS4): Every correct response and correct rejection is worth one point (up to 4 points possible).

Item Characteristics

Discrimination					
Measurement Type		Model A9	Model B	Model C	Model D
Correlation to participant ability (θ)		0.62	0.59	0.58	0.58
Discrimination Parameter (α)		0.57	0.60	0.51	0.61
Difficulty					
Measurement Type	Points	Model A9	Model B	Model C	Model D
Difficulty for participant of average ability level	4	-0.37	-0.39	-0.56	-0.38
	3	-0.77	-0.78	-1.06	-0.77
	2	-0.89	-0.90	-1.44	-0.89
	1	-2.76	-2.70	-4.10	-2.67
	0	NA	NA	NA	NA
Cumulative probability for participant of average ability level	4	61.9%	63.0%	64.4%	63.0%
	3	77.6%	79.0%	80.2%	79.0%
	2	81.2%	82.4%	87.5%	82.5%
	1	96.5%	96.8%	98.5%	96.9%
	0	100%	100%	100%	100%
Frequencies					
Groups	Points	Frequencies		Percent (%)	
Complete sample for this math problem (n = 543)	4	317		58.4%	
	3	70		12.9%	
	2	17		3.1%	
	1	100		18.4%	
	0	39		7.2%	
Female (n = 187)	4	99		52.9%	
	3	24		12.8%	
	2	8		4.3%	
	1	41		21.9%	
	0	15		8.0%	
Male (n = 347)	4	217		62.5%	
	3	45		13.0%	
	2	6		1.7%	
	1	57		16.4%	
	0	22		6.3%	
German as primary language at home (n = 408)	4	255		62.5%	
	3	54		13.2%	
	2	13		3.2%	
	1	60		14.7%	
	0	26		6.4%	

Frequencies			
Groups	Points	Frequencies	Percent (%)
Other language as primary language at home (n = 135)	4	62	45.9%
	3	16	11.9%
	2	4	3.0%
	1	40	29.6%
	0	13	9.6%
Secondary school completed in Germany (n = 482)	4	284	58.9%
	3	62	12.9%
	2	16	3.3%
	1	87	18.0%
	0	33	6.8%
Secondary school completed abroad (n = 60)	4	32	53.3%
	3	8	13.3%
	2	1	1.7%
	1	13	21.7%
	0	6	10.0%
Math not attended as advanced course in secondary school (n = 185)	4	66	35.7%
	3	23	12.4%
	2	15	8.1%
	1	60	32.4%
	0	21	11.4%
Math attended as advanced course in secondary school (n = 316)	4	229	72.5%
	3	38	12.0%
	2	1	0.3%
	1	33	10.4%
	0	15	4.7%
No math preparatory course attended (n = 242)	4	120	49.6%
	3	32	13.2%
	2	8	3.3%
	1	58	24.0%
	0	24	9.9%
Math preparatory course attended (n = 294)	4	194	66.0%
	3	38	12.9%
	2	9	3.1%
	1	40	13.6%
	0	13	4.4%
University of applied sciences (n = 136)	4	46	33.8%
	3	25	18.4%
	2	10	7.4%
	1	39	28.7%
	0	16	11.8%
University (n = 407)	4	271	66.6%
	3	45	11.1%
	2	7	1.7%
	1	61	15.0%
	0	23	5.7%

Frequencies			
Groups	Points	Frequencies	Percent (%)
Online Participation (n = 377)	4	203	53.8%
	3	53	14.1%
	2	14	3.7%
	1	79	21.0%
	0	28	7.4%
Pen-and-Paper Participation (n = 166)	4	114	68.7%
	3	17	10.2%
	2	3	1.8%
	1	21	12.7%
	0	11	6.6%
Attended Gymnasium (n = 409)	4	261	63.8%
	3	53	13.0%
	2	8	2.0%
	1	62	15.2%
	0	25	6.1%
Attended Other Secondary School (n = 128)	4	54	42.2%
	3	17	13.3%
	2	9	7.0%
	1	35	27.3%
	0	13	10.2%

Note. Due to missing values on demographics questions, frequencies within groups may not add up to the total number of responses.

Plots

All plots are generated from **Model A9**.

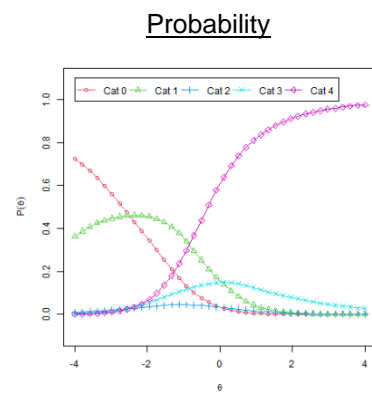
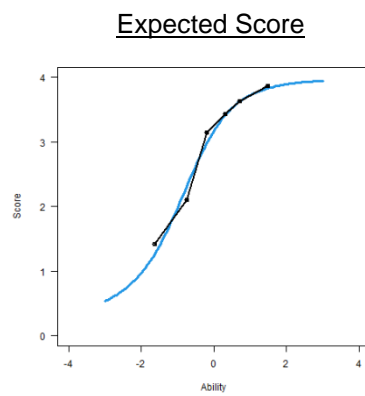
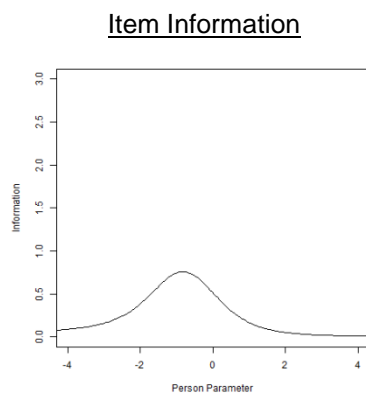

Note. The blue line represents expected performance, and the black line represents actual performance.

Note. Cat n = probability of receiving n points.

4.10. Linear Equation Systems (Lineare Gleichungssysteme; L)

Q₃ Statistics for Linear Equation Systems

	L1	L2	L3	L4	L5	L6	L7	L8	L9	L10	L11
L1	-										
L2	-.144	-									
L3	-.175	-.303	-								
L4	-.146	-.277	-.073	-							
L5	-.040	-.106	-.209	-.130	-						
L6	-.109	-.056	-.023	-.131	-.070	-					
L7	-.004	-.145	-.130	-.077	.140	-.144	-				
L8	-.217	-.015	-.169	-.227	-.057	-.158	-.055	-			
L9	-.050	-.064	-.118	-.157	-.128	-.117	-.102	-.001	-		
L10	-.186	.228	-.085	-.180	-.037	-.056	-.181	-.028	-.046	-	
L11	-.081	-.165	-.046	-.108	-.135	-.079	-.059	-.164	-.212	-.348	-

Note. Q₃ statistics above the critical absolute value of 0.20 are bolded. For details see **Section 3.1**.

4.10.1. Verifying Solutions (L1)

Lösungen verifizieren

Welche der folgenden Zahlenquadrupel sind Lösungen des linearen Gleichungssystems?

$$\begin{aligned} x_1 + 3x_2 - 5x_3 + x_4 &= 0 \\ x_2 - 3x_3 + 2x_4 &= 0 \end{aligned}$$

Wählen Sie eine oder mehrere richtige Antworten.

(1; -1; -1; -3)

(5; -2; 0; 1)

Math Problem ID

L1

Correct Answers and Answer Frequencies

Answer	Correct Answer(s)	Number Correct Answers	Number Incorrect Answers
(1; -1; -1; -3)	blinded	blinded	blinded
(5; -2; 0; 1)	blinded	blinded	blinded

Note. Scoring (PCS4): Every correct response and correct rejection is worth one point (up to 2 points possible).

Item Characteristics

Discrimination					
Measurement Type		Model A10	Model B	Model C	Model D
Correlation to participant ability (θ)		0.55	0.46	0.45	0.48
Discrimination Parameter (α)		0.71	0.61	0.68	0.66
Difficulty					
Measurement Type	Points	Model A10	Model B	Model C	Model D
Difficulty for participant of average ability level	2	-0.57	-0.71	-0.84	-0.66
	1	-0.94	-1.13	-1.36	-1.06
	0	NA	NA	NA	NA
Cumulative probability for participant of average ability level	2	66.7%	67.9%	71.7%	68.1%
	1	77.2%	77.9%	83.9%	78.2%
	0	100%	100%	100%	100%

Frequencies			
Groups	Points	Frequencies	Percent (%)
Complete sample for this math problem (n = 540)	2	340	63.0%
	1	50	9.3%
	0	150	27.8%
Female (n = 187)	2	104	55.6%
	1	21	11.2%
	0	62	33.2%
Male (n = 340)	2	225	66.2%
	1	29	8.5%
	0	86	25.3%
German as primary language at home (n = 397)	2	253	63.7%
	1	37	9.3%
	0	107	27.0%
Other language as primary language at home (n = 137)	2	83	60.6%
	1	13	9.5%
	0	41	29.9%
Secondary school completed in Germany (n = 479)	2	300	62.6%
	1	43	9.0%
	0	136	28.4%
Secondary school completed abroad (n = 58)	2	38	65.5%
	1	7	12.1%
	0	13	22.4%
Math not attended as advanced course in secondary school (n = 195)	2	97	49.7%
	1	17	8.7%
	0	81	41.5%
Math attended as advanced course in secondary school (n = 284)	2	209	73.6%
	1	24	8.5%
	0	51	18.0%
No math preparatory course attended (n = 244)	2	146	59.8%
	1	28	11.5%
	0	70	28.7%
Math preparatory course attended (n = 286)	2	187	65.4%
	1	21	7.3%
	0	78	27.3%
University of applied sciences (n = 140)	2	79	56.4%
	1	11	7.9%
	0	50	35.7%
University (n = 400)	2	261	65.3%
	1	39	9.8%
	0	100	25.0%
Online Participation (n = 379)	2	249	65.7%
	1	36	9.5%
	0	94	24.8%
Pen-and-Paper Participation (n = 161)	2	91	56.5%
	1	14	8.7%
	0	56	34.8%

Frequencies			
Groups	Points	Frequencies	Percent (%)
Attended Gymnasium (n = 383)	2	236	61.6%
	1	39	10.2%
	0	108	28.2%
Attended Other Secondary School (n = 146)	2	98	67.1%
	1	10	6.8%
	0	38	26.0%

Note. Due to missing values on demographics questions, frequencies within groups may not add up to the total number of responses.

Plots

All plots are generated from **Model A10**.

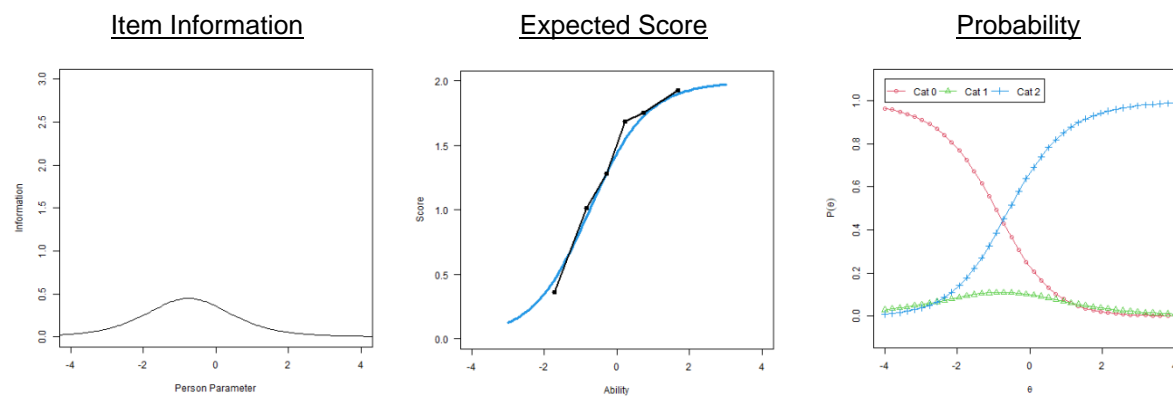

Note. The blue line represents expected performance, and the black line represents actual performance.

Note. Cat n = probability of receiving n points.

4.10.2. 2x2 With a Parameter (L2)

Version 1:

2x2 mit Parameter

Gegeben sei folgendes lineares Gleichungssystem. Geben Sie jeweils, falls möglich, eine reelle Zahl a an, so dass das Gleichungssystem die angegebene Anzahl von Lösungen für x und y hat. Falls das nicht möglich ist, geben Sie den Buchstaben k ein.

$$\begin{aligned}x + y &= -10 \\x + y &= a\end{aligned}$$

Ergänzen Sie die freien Felder.

keine Lösung:	$a =$	<input type="text"/>
genau eine Lösung:	$a =$	<input type="text"/>
unendlich viele Lösungen:	$a =$	<input type="text"/>

Version 2:

2x2 mit Parameter

Das folgende Gleichungssystem enthält den Parameter a . Entscheiden Sie, ob die unten stehenden Aussagen über a richtig sind.

$$\begin{aligned}x + y &= -10 \\x + y &= a\end{aligned}$$

Wählen Sie eine oder mehrere richtige Antworten.

a kann so gewählt werden, dass das Gleichungssystem keine Lösung hat.

a kann so gewählt werden, dass das Gleichungssystem genau eine Lösung hat.

a kann so gewählt werden, dass das Gleichungssystem genau zwei Lösungen hat.

a kann so gewählt werden, dass das Gleichungssystem unendlich viele Lösungen hat.

Math Problem ID

L2

Correct Answers and Answer Frequencies

Version 1:

Blank	Correct Answer(s)	Number Correct Answers	Number Incorrect Answers
1	blinded	blinded	blinded
2	blinded	blinded	blinded
3	blinded	blinded	blinded

Note. Scoring (PCS4): All blanks must be answered correctly to earn one point (up to 1 point possible).

Version 2:

Answer	Correct Answer(s)	Number Correct Answers	Number Incorrect Answers
a kann so gewählt werden, dass das Gleichungssystem keine Lösung hat.	blinded	blinded	blinded
a kann so gewählt werden, dass das Gleichungssystem genau eine Lösung hat.	blinded	blinded	blinded
a kann so gewählt werden, dass das Gleichungssystem genau zwei Lösungen hat.	blinded	blinded	blinded
a kann so gewählt werden, dass das Gleichungssystem unendlich viele Lösungen hat.	blinded	blinded	blinded

Note. Scoring (PCS4): Correctly choosing or correctly rejecting all answer options is worth one point (up to 1 point possible).

Item Characteristics

Discrimination					
Measurement Type		Model A10	Model B	Model C	Model D
Correlation to participant ability (θ)		0.63	0.62	0.62	0.60
Discrimination Parameter (α)		2.08	2.05	1.88	2.21
Difficulty					
Measurement Type	Points	Model A10	Model B	Model C	Model D
Difficulty for participant of average ability level	1	0.96	0.91	0.84	0.89
	0	NA	NA	NA	NA
Cumulative probability for participant of average ability level	1	11.9%	13.4%	17.0%	12.2%
	0	100%	100%	100%	100%
Frequencies					
Groups	Points	Frequencies		Percent (%)	
Complete sample for this math problem (n = 539)	1	125		23.2%	
	0	414		76.8%	
Female (n = 186)	1	46		24.7%	
	0	140		75.3%	
Male (n = 340)	1	76		22.4%	
	0	264		77.6%	
German as primary language at home (n = 396)	1	101		25.5%	
	0	295		74.5%	
Other language as primary language at home (n = 137)	1	22		16.1%	
	0	115		83.9%	

Frequencies			
Groups	Points	Frequencies	Percent (%)
Secondary school completed in Germany (n = 476)	1	107	22.5%
	0	369	77.5%
Secondary school completed abroad (n = 60)	1	17	28.3%
	0	43	71.7%
Math not attended as advanced course in secondary school (n = 194)	1	23	11.9%
	0	171	88.1%
Math attended as advanced course in secondary school (n = 282)	1	92	32.6%
	0	190	67.4%
No math preparatory course attended (n = 244)	1	40	16.4%
	0	204	83.6%
Math preparatory course attended (n = 284)	1	81	28.5%
	0	203	71.5%
University of applied sciences (n = 138)	1	16	11.6%
	0	122	88.4%
University (n = 401)	1	109	27.2%
	0	292	72.8%
Online Participation (n = 376)	1	97	25.8%
	0	279	74.2%
Pen-and-Paper Participation (n = 163)	1	28	17.2%
	0	135	82.8%
Attended Gymnasium (n = 382)	1	106	27.7%
	0	276	72.3%
Attended Other Secondary School (n = 145)	1	17	11.7%
	0	128	88.3%

Note. Due to missing values on demographics questions, frequencies within groups may not add up to the total number of responses.

Plots

All plots are generated from **Model A10**.

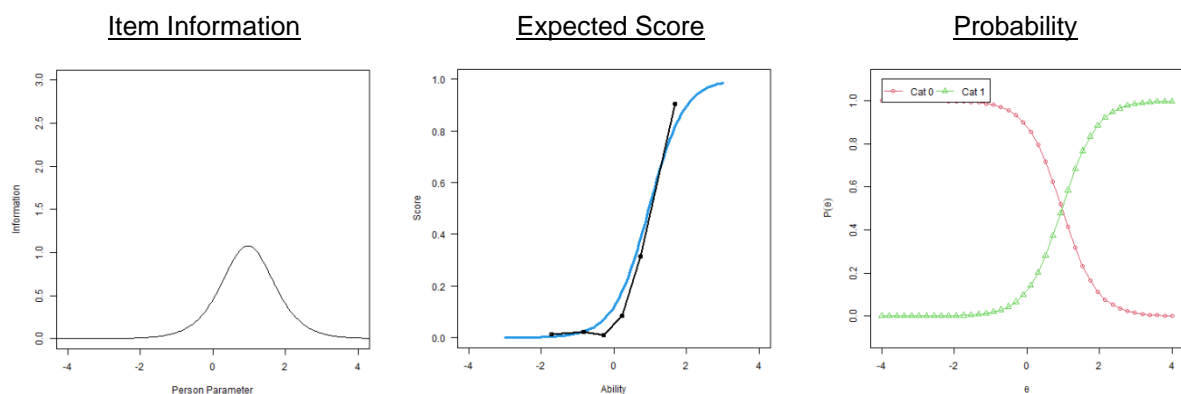

Note. The blue line represents expected performance, and the black line represents actual performance.

Note. Cat n = probability of receiving n points.

4.10.3. Parameter Based Solutions of Linear Equation Systems (L3)

Version 1:

LGS parameterabhängig lösen

Lösen Sie das folgende lineare Gleichungssystem, indem Sie Ihre Lösung in Abhängigkeit von $c \in \mathbb{R}$ angeben.

Ergänzen Sie die freien Felder.

Schreibweise:
*Nutzen Sie folgende Zeichen: + (Addition), - (Subtraktion), * (Multiplikation), / (Division), ^ (Potenz).*

$$\begin{aligned}x + 2y &= 4 \\ 2x + y &= 5 + 3c\end{aligned}$$

$x =$

$y =$

Version 2:

LGS parameterabhängig lösen

Das folgende lineare Gleichungssystem enthält den Parameter $c \in \mathbb{R}$. Geben Sie die Lösung in Abhängigkeit von c an.

Beachten Sie: c ist nicht zu bestimmen, sondern steht für eine beliebige, aber als fest zu betrachtende reelle Zahl.

Ergänzen Sie die freien Felder.

Schreibweise:
*Nutzen Sie folgende Zeichen: + (Addition), - (Subtraktion), * (Multiplikation), / (Division), ^ (Potenz).*

$$\begin{aligned}-2x - 4y &= -8 \\ 2x + y &= 5 + 3c\end{aligned}$$

$x =$

$y =$

Math Problem ID

L3

Correct Answers and Answer Frequencies

Blank	Correct Answer(s)	Number Correct Answers	Number Incorrect Answers
1	blinded	blinded	blinded
2	blinded	blinded	blinded

Note. Scoring (PCS4): Every correct response is worth one point (up to 2 points possible).

Item Characteristics

Discrimination					
Measurement Type		Model A10	Model B	Model C	Model D
Correlation to participant ability (θ)		0.63	0.56	0.55	0.56
Discrimination Parameter (α)		0.89	0.78	0.73	0.86
Difficulty					
Measurement Type	Points	Model A10	Model B	Model C	Model D
Difficulty for participant of average ability level	2	0.73	0.70	0.63	0.68
	1	0.37	0.30	0.20	0.31
	0	NA	NA	NA	NA
Cumulative probability for participant of average ability level	2	24.0%	27.5%	30.7%	26.2%
	1	36.5%	40.1%	43.8%	39.0%
	0	100%	100%	100%	100%
Frequencies					
Groups	Points	Frequencies	Percent (%)		
Complete sample for this math problem (n = 523)	2	164	31.4%		
	1	55	10.5%		
	0	304	58.1%		
Female (n = 178)	2	51	28.7%		
	1	19	10.7%		
	0	108	60.7%		
Male (n = 333)	2	107	32.1%		
	1	36	10.8%		
	0	190	57.1%		
German as primary language at home (n = 380)	2	111	29.2%		
	1	45	11.8%		
	0	224	58.9%		
Other language as primary language at home (n = 139)	2	52	37.4%		
	1	10	7.2%		
	0	77	55.4%		
Secondary school completed in Germany (n = 465)	2	136	29.2%		
	1	53	11.4%		
	0	276	59.4%		
Secondary school completed abroad (n = 55)	2	27	49.1%		
	1	2	3.6%		
	0	26	47.3%		

Frequencies			
Groups	Points	Frequencies	Percent (%)
Math not attended as advanced course in secondary school (n = 192)	2	26	13.5%
	1	14	7.3%
	0	152	79.2%
Math attended as advanced course in secondary school (n = 272)	2	112	41.2%
	1	36	13.2%
	0	124	45.6%
No math preparatory course attended (n = 244)	2	78	32.0%
	1	19	7.8%
	0	147	60.2%
Math preparatory course attended (n = 269)	2	83	30.9%
	1	35	13.0%
	0	151	56.1%
University of applied sciences (n = 132)	2	28	21.2%
	1	11	8.3%
	0	93	70.5%
University (n = 391)	2	136	34.8%
	1	44	11.3%
	0	211	54.0%
Online Participation (n = 362)	2	121	33.4%
	1	36	9.9%
	0	205	56.6%
Pen-and-Paper Participation (n = 161)	2	43	26.7%
	1	19	11.8%
	0	99	61.5%
Attended Gymnasium (n = 369)	2	125	33.9%
	1	43	11.7%
	0	201	54.5%
Attended Other Secondary School (n = 141)	2	35	24.8%
	1	11	7.8%
	0	95	67.4%

Note. Due to missing values on demographics questions, frequencies within groups may not add up to the total number of responses.

Plots

All plots are generated from **Model A10**.

Item Information

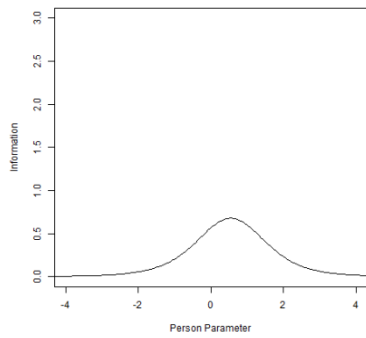

Expected Score

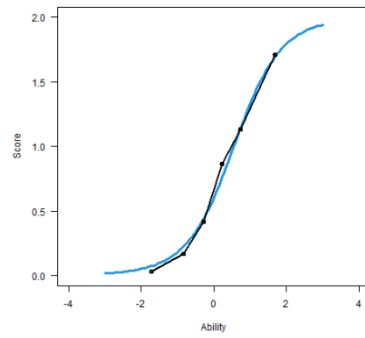

Probability

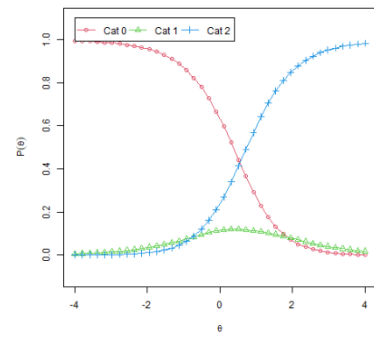

Note. The blue line represents expected performance, and the black line represents actual performance.

Note. Cat n = probability of receiving n points.

4.10.4. Specifying Coefficients (L4)

Koeffizienten bestimmen

Gegeben ist die Funktion $f(x) = a \cdot x^2 + bx + c$ deren Graph durch die Punkte $A(-1|0)$, $B(0|-1)$ und $C(1|4)$ geht. Geben Sie ein lineares Gleichungssystem an, mit dem man die Koeffizienten a , b und c bestimmen könnte.

Wählen Sie dazu genau die drei Gleichungen aus, die aus den drei Punkten aufgestellt werden können.

$$1 \cdot a - 1 \cdot b - 1 \cdot c = 0$$

$$1 \cdot a + 1 \cdot b + 1 \cdot c = 4$$

$$1 \cdot a - 1 \cdot b + 1 \cdot c = 0$$

$$-1 \cdot a - 1 \cdot b + 1 \cdot c = 0$$

$$16 \cdot a + 4 \cdot b + 1 \cdot c = 1$$

$$0 \cdot a + 0 \cdot b + 1 \cdot c = -1$$

Math Problem ID

L4

Correct Answers and Answer Frequencies

Answer	Correct Answer(s)	Number Correct Answers	Number Incorrect Answers
$1 \cdot a - 1 \cdot b - 1 \cdot c = 0$	blinded	blinded	blinded
$1 \cdot a + 1 \cdot b + 1 \cdot c = 4$	blinded	blinded	blinded
$1 \cdot a - 1 \cdot b + 1 \cdot c = 0$	blinded	blinded	blinded
$-1 \cdot a - 1 \cdot b + 1 \cdot c = 0$	blinded	blinded	blinded
$16 \cdot a + 4 \cdot b + 1 \cdot c = 1$	blinded	blinded	blinded
$0 \cdot a + 0 \cdot b + 1 \cdot c = -1$	blinded	blinded	blinded

Note. Scoring (PCS4): Every correctly chosen option is worth one point. Correct rejections and incorrect choices are ignored (up to 3 points possible).

Item Characteristics

Discrimination					
Measurement Type		Model A10	Model B	Model C	Model D
Correlation to participant ability (θ)		0.65	0.58	0.58	0.60
Discrimination Parameter (α)		0.75	0.67	0.68	0.74
Difficulty					
Measurement Type	Points	Model A10	Model B	Model C	Model D
Difficulty for participant of average ability level	3	0.60	0.55	0.44	0.54
	2	-0.38	-0.53	-0.68	-0.48
	1	-1.07	-1.28	-1.53	-1.19
	0	NA	NA	NA	NA
Cumulative probability for participant of average ability level	3	32.3%	35.3%	38.5%	34.5%
	2	64.0%	67.0%	71.2%	66.8%
	1	82.5%	84.4%	88.3%	84.6%
	0	100%	100%	100%	100%
Frequencies					
Groups	Points	Frequencies		Percent (%)	
Complete sample for this math problem (n = 516)	3	183		35.5%	
	2	133		25.8%	
	1	83		16.1%	
	0	117		22.7%	
Female (n = 177)	3	61		34.5%	
	2	44		24.9%	
	1	33		18.6%	
	0	39		22.0%	
Male (n = 328)	3	119		36.3%	
	2	88		26.8%	
	1	48		14.6%	
	0	73		22.3%	
German as primary language at home (n = 375)	3	141		37.6%	
	2	105		28.0%	
	1	50		13.3%	
	0	79		21.1%	
Other language as primary language at home (n = 137)	3	40		29.2%	
	2	28		20.4%	
	1	33		24.1%	
	0	36		26.3%	
Secondary school completed in Germany (n = 459)	3	165		35.9%	
	2	121		26.4%	
	1	73		15.9%	
	0	100		21.8%	

Frequencies			
Groups	Points	Frequencies	Percent (%)
Secondary school completed abroad (n = 54)	3	17	31.5%
	2	12	22.2%
	1	10	18.5%
	0	15	27.8%
Math not attended as advanced course in secondary school (n = 189)	3	35	18.5%
	2	53	28.0%
	1	45	23.8%
	0	56	29.6%
Math attended as advanced course in secondary school (n = 268)	3	129	48.1%
	2	71	26.5%
	1	27	10.1%
	0	41	15.3%
No math preparatory course attended (n = 239)	3	64	26.8%
	2	65	27.2%
	1	49	20.5%
	0	61	25.5%
Math preparatory course attended (n = 267)	3	114	42.7%
	2	68	25.5%
	1	32	12.0%
	0	53	19.9%
University of applied sciences (n = 132)	3	27	20.5%
	2	31	23.5%
	1	29	22.0%
	0	45	34.1%
University (n = 384)	3	156	40.6%
	2	102	26.6%
	1	54	14.1%
	0	72	18.8%
Online Participation (n = 356)	3	130	36.5%
	2	92	25.8%
	1	55	15.4%
	0	79	22.2%
Pen-and-Paper Participation (n = 160)	3	53	33.1%
	2	41	25.6%
	1	28	17.5%
	0	38	23.8%
Attended Gymnasium (n = 363)	3	144	39.7%
	2	99	27.3%
	1	43	11.8%
	0	77	21.2%
Attended Other Secondary School (n = 140)	3	37	26.4%
	2	32	22.9%
	1	35	25.0%
	0	36	25.7%

Note. Due to missing values on demographics questions, frequencies within groups may not add up to the total number of responses.

Plots

All plots are generated from **Model A10**.

Item Information

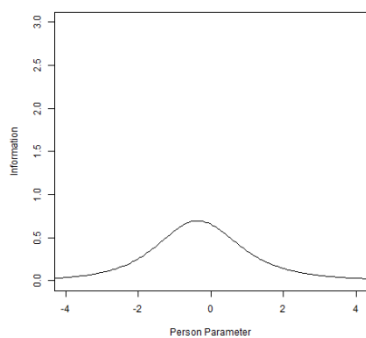

Expected Score

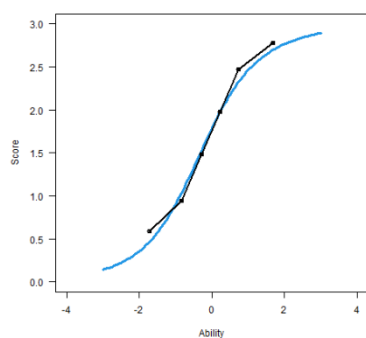

Note. The blue line represents expected performance, and the black line represents actual performance.

Probability

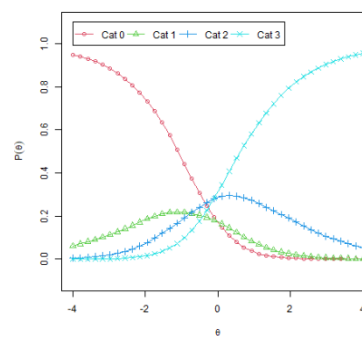

Note. Cat n = probability of receiving n points.

4.10.5. Matrix and Vector (L5)

Matrix und Vektor

Berechnen Sie ohne Taschenrechner oder andere technische Hilfsmittel.

Ergänzen Sie die freien Felder.

$$\begin{pmatrix} 1 & 2 \\ 1 & 3 \end{pmatrix} \cdot \begin{pmatrix} 4 \\ -1 \end{pmatrix} = \begin{pmatrix} \square \\ \square \end{pmatrix}$$

Math Problem ID

L5

Correct Answers and Answer Frequencies

Blank	Correct Answer(s)	Number Correct Answers	Number Incorrect Answers
1	blinded	blinded	blinded
2	blinded	blinded	blinded

Note. Scoring (PCS4): Correctly answering both blanks is worth one point (up to 1 point possible).

Item Characteristics

Discrimination					
Measurement Type		Model A10	Model B	Model C	Model D
Correlation to participant ability (θ)		0.53	0.44	0.44	0.44
Discrimination Parameter (α)		1.26	1.04	0.98	1.15
Difficulty					
Measurement Type	Points	Model A10	Model B	Model C	Model D
Difficulty for participant of average ability level	1	0.91	0.94	0.89	0.90
	0	NA	NA	NA	NA
Cumulative probability for participant of average ability level	1	24.1%	27.2%	29.5%	26.2%
	0	100%	100%	100%	100%
Frequencies					
Groups	Points	Frequencies		Percent (%)	
Complete sample for this math problem (n = 512)	1	154		30.1%	
	0	358		69.9%	
Female (n = 175)	1	62		35.4%	
	0	113		64.6%	
Male (n = 326)	1	90		27.6%	
	0	236		72.4%	

Frequencies			
Groups	Points	Frequencies	Percent (%)
German as primary language at home (n = 373)	1	109	29.2%
	0	264	70.8%
Other language as primary language at home (n = 135)	1	45	33.3%
	0	90	66.7%
Secondary school completed in Germany (n = 456)	1	134	29.4%
	0	322	70.6%
Secondary school completed abroad (n = 53)	1	20	37.7%
	0	33	62.3%
Math not attended as advanced course in secondary school (n = 187)	1	29	15.5%
	0	158	84.5%
Math attended as advanced course in secondary school (n = 267)	1	108	40.4%
	0	159	59.6%
No math preparatory course attended (n = 239)	1	70	29.3%
	0	169	70.7%
Math preparatory course attended (n = 264)	1	82	31.1%
	0	182	68.9%
University of applied sciences (n = 131)	1	26	19.8%
	0	105	80.2%
University (n = 381)	1	128	33.6%
	0	253	66.4%
Online Participation (n = 352)	1	121	34.4%
	0	231	65.6%
Pen-and-Paper Participation (n = 160)	1	33	20.6%
	0	127	79.4%
Attended Gymnasium (n = 360)	1	125	34.7%
	0	235	65.3%
Attended Other Secondary School (n = 139)	1	27	19.4%
	0	112	80.6%

Note. Due to missing values on demographics questions, frequencies within groups may not add up to the total number of responses.

Plots

All plots are generated from **Model A10**.

Item Information

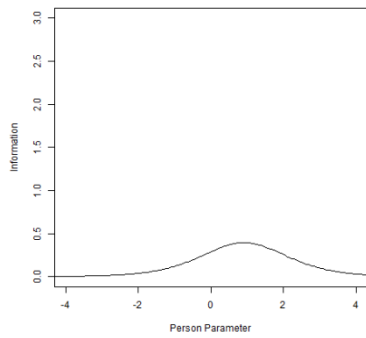

Expected Score

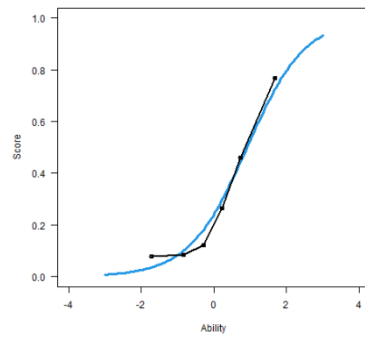

Probability

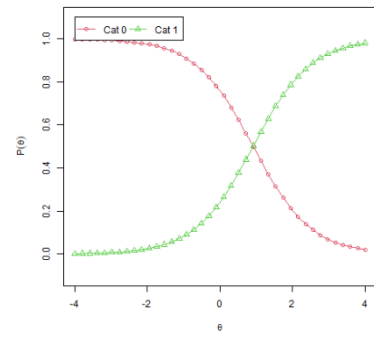

Note. The blue line represents expected performance, and the black line represents actual performance.

Note. Cat n = probability of receiving n points.

4.10.6. Graphically Solving Linear Equation Systems (L6)

LGS graphisch lösen

Gegeben ist das folgende lineare Gleichungssystem. Wählen Sie die korrekte graphische Darstellung des Gleichungssystems aus.

$$\begin{aligned} 3x - y &= 1 \\ 2x + 2y &= 14 \end{aligned}$$

Wählen Sie die richtige Antwort.

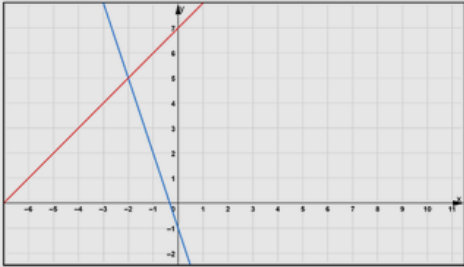

A

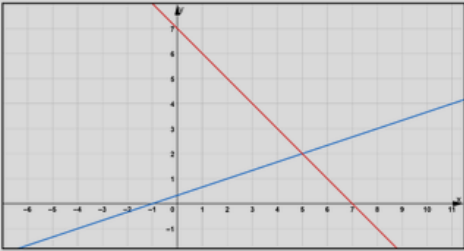

B

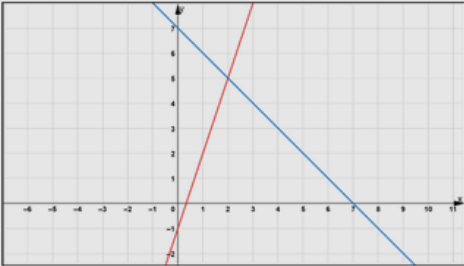

C

Math Problem ID

L6

Correct Answers and Answer Frequencies

Correct Answer	Number Correct Answers	Number Incorrect Answers ^a	Answer Frequencies		
			A	B	C
blinded	blinded	blinded	blinded	blinded	blinded

Note. Scoring (PCS4): Every correct response is worth one point (up to 1 point possible).

^a Includes cases, where the problem was seen but not answered.

Item Characteristics

Discrimination					
Measurement Type		Model A10	Model B	Model C	Model D
Correlation to participant ability (θ)		0.50	0.45	0.44	0.47
Discrimination Parameter (α)		1.11	1.06	1.03	1.11
Difficulty					
Measurement Type	Points	Model A10	Model B	Model C	Model D
Difficulty for participant of average ability level	1	-0.59	-0.70	-0.86	-0.67
	0	NA	NA	NA	NA
Cumulative probability for participant of average ability level	1	66.0%	67.8%	70.7%	67.8%
	0	100%	100%	100%	100%
Frequencies					
Groups	Points	Frequencies		Percent (%)	
Complete sample for this math problem (n = 535)	1	339		63.4%	
	0	196		36.6%	
Female (n = 184)	1	114		62.0%	
	0	70		38.0%	
Male (n = 338)	1	215		63.6%	
	0	123		36.4%	
German as primary language at home (n = 395)	1	242		61.3%	
	0	153		38.7%	
Other language as primary language at home (n = 134)	1	93		69.4%	
	0	41		30.6%	
Secondary school completed in Germany (n = 474)	1	294		62.0%	
	0	180		38.0%	
Secondary school completed abroad (n = 58)	1	43		74.1%	
	0	15		25.9%	
Math not attended as advanced course in secondary school (n = 193)	1	94		48.7%	
	0	99		51.3%	
Math attended as advanced course in secondary school (n = 282)	1	202		71.6%	
	0	80		28.4%	
No math preparatory course attended (n = 241)	1	140		58.1%	
	0	101		41.9%	
Math preparatory course attended (n = 284)	1	193		68.0%	
	0	91		32.0%	
University of applied sciences (n = 138)	1	71		51.4%	
	0	67		48.6%	
University (n = 397)	1	268		67.5%	
	0	129		32.5%	
Online Participation (n = 375)	1	238		63.5%	
	0	137		36.5%	
Pen-and-Paper Participation (n = 160)	1	101		63.1%	
	0	59		36.9%	

Frequencies			
Groups	Points	Frequencies	Percent (%)
Attended Gymnasium (n = 380)	1	251	66.1%
	0	129	33.9%
Attended Other Secondary School (n = 144)	1	81	56.3%
	0	63	43.8%

Note. Due to missing values on demographics questions, frequencies within groups may not add up to the total number of responses.

Plots

All plots are generated from **Model A10**.

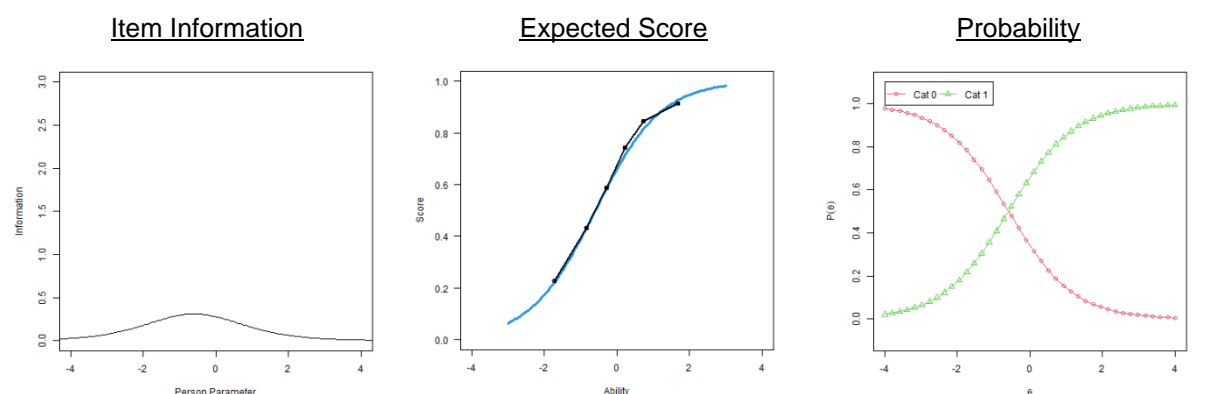

Note. The blue line represents expected performance, and the black line represents actual performance.

Note. Cat n = probability of receiving n points.

4.10.7. Matrix and Vector Notation (L7)

Matrix-Vektor-Schreibweise

Gegeben ist das folgende lineare Gleichungssystem:

$$\begin{aligned} x - 2y &= 2 \\ 3x + 4y &= 16 \end{aligned}$$

Wählen Sie aus, welcher der folgenden Ausdrücke das lineare Gleichungssystem in Matrix-Vektor-Schreibweise darstellt.

Wählen Sie die richtige Antwort.

$$\begin{pmatrix} x \\ y \end{pmatrix} \begin{pmatrix} 1 & 3 \\ -2 & 4 \end{pmatrix} = \begin{pmatrix} 2 \\ 16 \end{pmatrix} \quad \text{A}$$

$$\begin{pmatrix} 1 & -2 \\ 3 & 4 \end{pmatrix} \begin{pmatrix} 2 \\ 16 \end{pmatrix} = \begin{pmatrix} x \\ y \end{pmatrix} \quad \text{B}$$

$$\begin{pmatrix} 1 & -2 \\ 3 & 4 \end{pmatrix} \begin{pmatrix} x \\ y \end{pmatrix} = \begin{pmatrix} 2 \\ 16 \end{pmatrix} \quad \text{C}$$

$$\begin{pmatrix} 1 & 3 \\ -2 & 4 \end{pmatrix} \begin{pmatrix} x \\ y \end{pmatrix} = \begin{pmatrix} 2 \\ 16 \end{pmatrix} \quad \text{D}$$

Math Problem ID

L7

Correct Answers and Answer Frequencies

Correct Answer	Number Correct Answers	Number Incorrect Answers ^a	Answer Frequencies			
			A	B	C	D
blinded	blinded	blinded	blinded	blinded	blinded	blinded

Note. Scoring (PCS4): Every correct response is worth one point (up to 1 point possible).

^a Includes cases, where the problem was seen but not answered.

Item Characteristics

Discrimination					
Measurement Type		Model A10	Model B	Model C	Model D
Correlation to participant ability (θ)		0.43	0.31	0.32	0.32
Discrimination Parameter (α)		0.86	0.62	0.60	0.71
Difficulty					
Measurement Type	Points	Model A10	Model B	Model C	Model D
Difficulty for participant of average ability level	1	0.04	-0.06	-0.19	-0.04
	0	NA	NA	NA	NA
Cumulative probability for participant of average ability level	1	49.2%	51.0%	52.9%	50.7%
	0	100%	100%	100%	100%
Frequencies					
Groups	Points	Frequencies		Percent (%)	
Complete sample for this math problem (n = 528)	1	264		50.0%	
	0	264		50.0%	
Female (n = 178)	1	86		48.3%	
	0	92		51.7%	
Male (n = 338)	1	173		51.2%	
	0	165		48.8%	
German as primary language at home (n = 385)	1	194		50.4%	
	0	191		49.6%	
Other language as primary language at home (n = 139)	1	70		50.4%	
	0	69		49.6%	
Secondary school completed in Germany (n = 470)	1	228		48.5%	
	0	242		51.5%	
Secondary school completed abroad (n = 55)	1	36		65.5%	
	0	19		34.5%	
Math not attended as advanced course in secondary school (n = 196)	1	78		39.8%	
	0	118		60.2%	
Math attended as advanced course in secondary school (n = 272)	1	155		57.0%	
	0	117		43.0%	
No math preparatory course attended (n = 246)	1	114		46.3%	
	0	132		53.7%	
Math preparatory course attended (n = 271)	1	147		54.2%	
	0	124		45.8%	
University of applied sciences (n = 135)	1	53		39.3%	
	0	82		60.7%	
University (n = 393)	1	211		53.7%	
	0	182		46.3%	
Online Participation (n = 367)	1	189		51.5%	
	0	178		48.5%	
Pen-and-Paper Participation (n = 161)	1	75		46.6%	
	0	86		53.4%	

Frequencies			
Groups	Points	Frequencies	Percent (%)
Attended Gymnasium (n = 370)	1	196	53.0%
	0	174	47.0%
Attended Other Secondary School (n = 145)	1	64	44.1%
	0	81	55.9%

Note. Due to missing values on demographics questions, frequencies within groups may not add up to the total number of responses.

Plots

All plots are generated from **Model A10**.

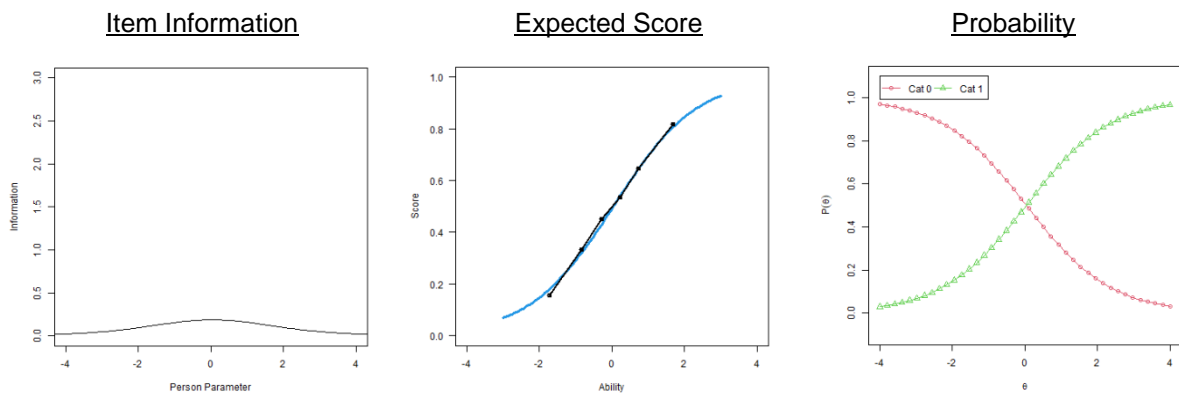

Note. The blue line represents expected performance, and the black line represents actual performance.

Note. Cat n = probability of receiving n points.

4.10.8. Choosing Appropriate Procedures to Solve a Linear Equation System (L8)

Zuordnen von geeigneten Lösungsverfahren

Gegeben sind zwei Gleichungssysteme mit je zwei Gleichungen und zwei Unbekannten. Ordnen Sie jedem Gleichungssystem das Lösungsverfahren zu, das jeweils direkt sinnvoll anwendbar ist.

Wählen Sie jeweils die richtige Antwort.

$$\begin{aligned} 2x + 4y &= 8 \\ x &= y + 1 \end{aligned}$$

Einsetzungsverfahren

v

$$\begin{aligned} x + 2y &= 19 \\ x - 2y &= -9 \end{aligned}$$

Additionsverfahren

v

Math Problem ID

L8

Answer Options

Answer Code	Answer Text
A	Gleichsetzungsverfahren
B	Einsetzungsverfahren
C	Additionsverfahren
D	Subtraktionsverfahren (removed)

Note. Answer option D was removed after the first data collection because it was almost never chosen.

Correct Answers and Answer Frequencies

Math Problem Part	Correct Answer	Number Correct Answers	Number Incorrect Answers ^a	Answer Frequencies		
				A	B	C
1. Linear Equation System	blinded	blinded	blinded	blinded	blinded	blinded
2. Linear Equation System	blinded	blinded	blinded	blinded	blinded	blinded

Note. Scoring (PCS4): Every correct response is worth one point (up to 2 points possible). Answer option D only appeared in the initial version of the test, and is excluded here.

^a Includes cases, where the problem was seen but not answered.

Item Characteristics

Discrimination					
Measurement Type		Model A10	Model B	Model C	Model D
Correlation to participant ability (θ)		0.63	0.53	0.52	0.55
Discrimination Parameter (α)		1.12	1.03	1.10	1.14
Difficulty					
Measurement Type	Points	Model A10	Model B	Model C	Model D
Difficulty for participant of average ability level	2	-0.62	-0.73	-0.86	-0.69
	1	-1.67	-1.83	-1.96	-1.73
	0	NA	NA	NA	NA
Cumulative probability for participant of average ability level	2	70.3%	71.9%	76.0%	72.4%
	1	94.6%	94.8%	96.6%	95.4%
	0	100%	100%	100%	100%
Frequencies					
Groups	Points	Frequencies		Percent (%)	
Complete sample for this math problem (n = 550)	2	355		64.5%	
	1	128		23.3%	
	0	67		12.2%	
Female (n = 189)	2	121		64.0%	
	1	46		24.3%	
	0	22		11.6%	
Male (n = 348)	2	224		64.4%	
	1	81		23.3%	
	0	43		12.4%	
German as primary language at home (n = 402)	2	271		67.4%	
	1	87		21.6%	
	0	44		10.9%	
Other language as primary language at home (n = 142)	2	80		56.3%	
	1	40		28.2%	
	0	22		15.5%	
Secondary school completed in Germany (n = 487)	2	323		66.3%	
	1	107		22.0%	
	0	57		11.7%	
Secondary school completed abroad (n = 60)	2	30		50.0%	
	1	21		35.0%	
	0	9		15.0%	
Math not attended as advanced course in secondary school (n = 198)	2	90		45.5%	
	1	68		34.3%	
	0	40		20.2%	
Math attended as advanced course in secondary school (n = 289)	2	228		78.9%	
	1	43		14.9%	
	0	18		6.2%	

Frequencies			
Groups	Points	Frequencies	Percent (%)
No math preparatory course attended (n = 252)	2	149	59.1%
	1	71	28.2%
	0	32	12.7%
Math preparatory course attended (n = 288)	2	200	69.4%
	1	57	19.8%
	0	31	10.8%
University of applied sciences (n = 142)	2	61	43.0%
	1	49	34.5%
	0	32	22.5%
University (n = 408)	2	294	72.1%
	1	79	19.4%
	0	35	8.6%
Online Participation (n = 388)	2	249	64.2%
	1	89	22.9%
	0	50	12.9%
Pen-and-Paper Participation (n = 162)	2	106	65.4%
	1	39	24.1%
	0	17	10.5%
Attended Gymnasium (n = 390)	2	274	70.3%
	1	81	20.8%
	0	35	9.0%
Attended Other Secondary School (n = 149)	2	75	50.3%
	1	46	30.9%
	0	28	18.8%

Note. Due to missing values on demographics questions, frequencies within groups may not add up to the total number of responses.

Plots

All plots are generated from **Model A10**.

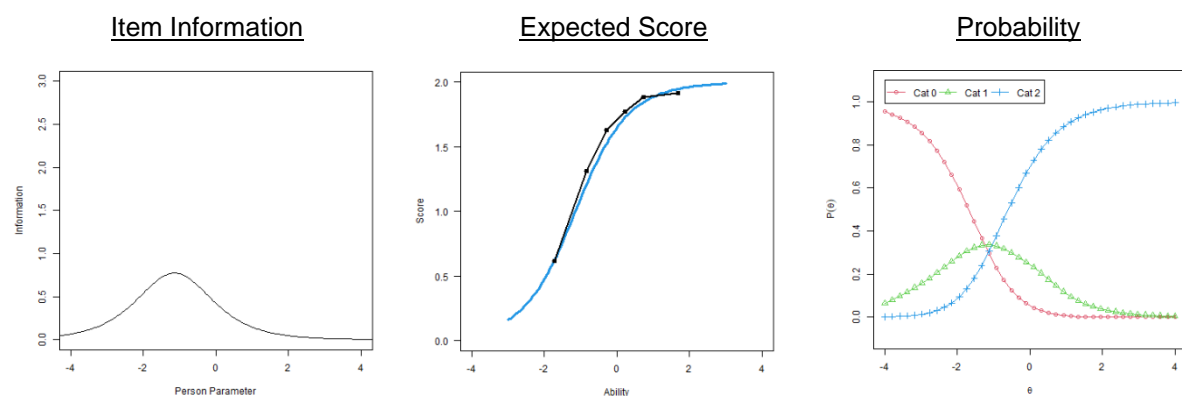

Note. The blue line represents expected performance, and the black line represents actual performance.

Note. Cat n = probability of receiving n points.

4.10.9. Conversions in Linear Equation Systems (L9)

Umformungen im Gleichungssystem

Gegeben sei ein lineares Gleichungssystem mit mehr Zeilen als Unbekannten. Welcher der folgenden Schritte verfälscht im allgemeinen die Lösungsmenge?

Wählen Sie die richtige Antwort.

Multiplizieren einer Zeile mit einer Zahl ungleich 0.
A

Zeilen aufeinander addieren. Die addierte Zeile bleibt weiter erhalten.
B

Streichen von Zeilen, bis die Anzahl an Zeilen und Unbekannten gleich ist.
C

Vertauschen von Zeilen.
D

Math Problem ID

L9

Correct Answers and Answer Frequencies

Correct Answer	Number Correct Answers	Number Incorrect Answers ^a	Answer Frequencies			
			A	B	C	D
blinded	blinded	blinded	blinded	blinded	blinded	blinded

Note. Scoring (PCS4): Every correct response is worth one point (up to 1 point possible).

^a Includes cases, where the problem was seen but not answered.

Item Characteristics

Discrimination					
Measurement Type		Model A10	Model B	Model C	Model D
Correlation to participant ability (θ)		0.49	0.44	0.44	0.44
Discrimination Parameter (α)		1.08	1.03	1.01	1.09
Difficulty					
Measurement Type	Points	Model A10	Model B	Model C	Model D
Difficulty for participant of average ability level	1	-0.54	-0.64	-0.79	-0.61
	0	NA	NA	NA	NA
Cumulative probability for participant of average ability level	1	64.2%	66.0%	69.1%	66.0%
	0	100%	100%	100%	100%

Frequencies			
Groups	Points	Frequencies	Percent (%)
Complete sample for this math problem (n = 546)	1	337	61.7%
	0	209	38.3%
Female (n = 188)	1	114	60.6%
	0	74	39.4%
Male (n = 345)	1	215	62.3%
	0	130	37.7%
German as primary language at home (n = 400)	1	273	68.3%
	0	127	31.8%
Other language as primary language at home (n = 140)	1	61	43.6%
	0	79	56.4%
Secondary school completed in Germany (n = 483)	1	311	64.4%
	0	171	35.6%
Secondary school completed abroad (n = 60)	1	24	40.0%
	0	36	60.0%
Math not attended as advanced course in secondary school (n = 198)	1	109	55.1%
	0	89	44.9%
Math attended as advanced course in secondary school (n = 285)	1	200	70.2%
	0	85	29.8%
No math preparatory course attended (n = 250)	1	132	52.8%
	0	118	47.1%
Math preparatory course attended (n = 286)	1	199	69.6%
	0	87	30.4%
University of applied sciences (n = 142)	1	70	49.3%
	0	72	50.7%
University (n = 404)	1	267	66.1%
	0	137	33.9%
Online Participation (n = 384)	1	243	63.3%
	0	141	36.7%
Pen-and-Paper Participation (n = 162)	1	94	58.0%
	0	68	42.0%
Attended Gymnasium (n = 386)	1	261	67.6%
	0	125	32.4%
Attended Other Secondary School (n = 149)	1	72	48.3%
	0	77	51.7%

Note. Due to missing values on demographics questions, frequencies within groups may not add up to the total number of responses.

Plots

All plots are generated from **Model A10**.

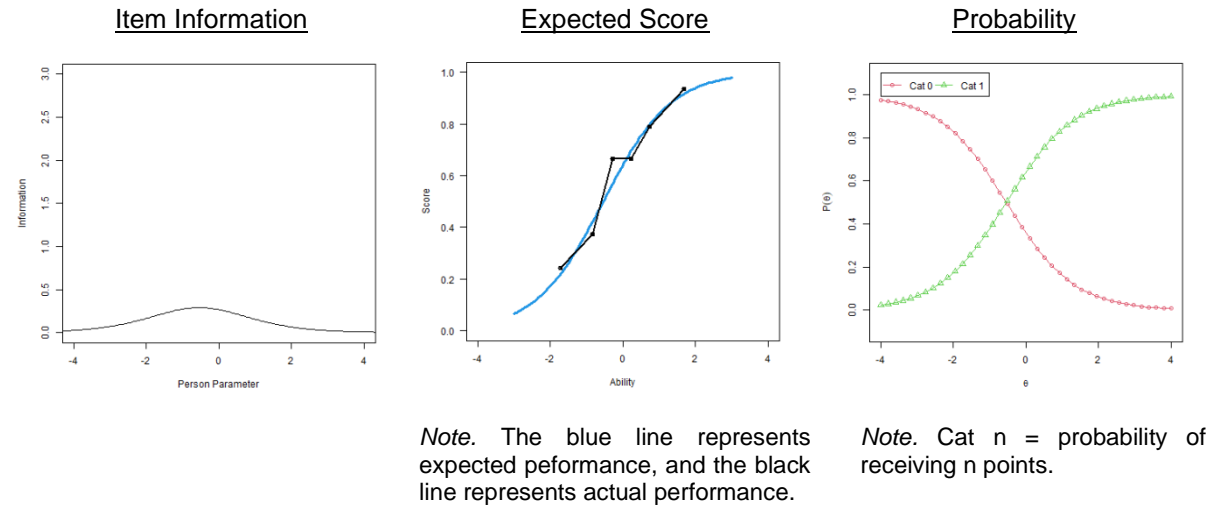

Differential Item Functioning (DIF)

This problem shows DIF across primary language. The difficulty (β) parameter was significantly higher for those who spoke a different language than German as their primary language at home. This shows that the problem was significantly easier for those who spoke German at home.

Expected Score (German as primary language)

Expected Score (other primary language)

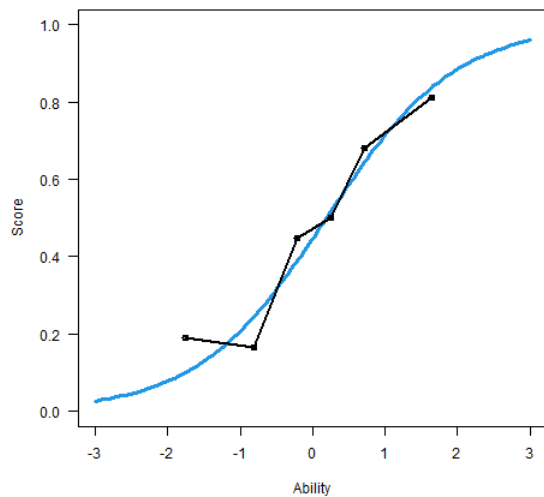
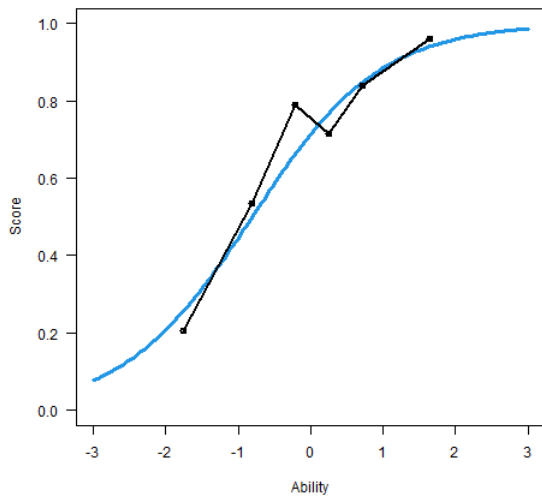

Note. The blue line represents expected performance, and the black line represents actual performance.

4.10.10. Graphic Interpretation of a Solution Set (L10)

Graphische Interpretation einer Lösungsmenge

Gegeben seien die Geraden g und h . Bildet man aus ihren Gleichungen ein lineares Gleichungssystem, so hat dieses genau eine Lösung. Welche Folgerung lässt sich daraus ziehen?

Wählen Sie die richtige Antwort.

g und h schneiden sich in genau einem Punkt. A

g und h sind parallel zueinander. B

g und h sind identisch. C

Math Problem ID

L10

Correct Answers and Answer Frequencies

Correct Answer	Number Correct Answers	Number Incorrect Answers ^a	Answer Frequencies		
			A	B	C
blinded	blinded	blinded	blinded	blinded	blinded

Note. Scoring (PCS4): Every correct response is worth one point (up to 1 point possible).

^a Includes cases, where the problem was seen but not answered.

Item Characteristics

Discrimination					
Measurement Type		Model A10	Model B	Model C	Model D
Correlation to participant ability (θ)		0.49	0.44	0.43	0.45
Discrimination Parameter (α)		1.83	1.65	1.28	1.80
Difficulty					
Measurement Type	Points	Model A10	Model B	Model C	Model D
Difficulty for participant of average ability level	1	-1.45	-1.68	-2.01	-1.58
	0	NA	NA	NA	NA
Cumulative probability for participant of average ability level	1	93.5%	94.1%	92.9%	94.5%
	0	100%	100%	100%	100%

Frequencies			
Groups	Points	Frequencies	Percent (%)
Complete sample for this math problem (n = 530)	1	458	86.4%
	0	72	13.6%
Female (n = 179)	1	150	83.8%
	0	29	16.2%
Male (n = 338)	1	297	87.9%
	0	41	12.1%
German as primary language at home (n = 386)	1	336	87.0%
	0	50	13.0%
Other language as primary language at home (n = 139)	1	118	84.9%
	0	21	15.1%
Secondary school completed in Germany (n = 471)	1	409	86.8%
	0	62	13.2%
Secondary school completed abroad (n = 55)	1	46	83.6%
	0	9	16.4%
Math not attended as advanced course in secondary school (n = 196)	1	158	80.6%
	0	38	19.4%
Math attended as advanced course in secondary school (n = 272)	1	250	91.9%
	0	22	8.1%
No math preparatory course attended (n = 247)	1	206	83.4%
	0	41	16.6%
Math preparatory course attended (n = 241)	1	243	89.7%
	0	28	10.3%
University of applied sciences (n = 135)	1	98	72.6%
	0	37	27.4%
University (n = 395)	1	360	91.1%
	0	35	8.9%
Online Participation (n = 369)	1	318	86.2%
	0	51	13.8%
Pen-and-Paper Participation (n = 161)	1	140	87.0%
	0	21	13.0%
Attended Gymnasium (n = 371)	1	332	89.5%
	0	39	10.5%
Attended Other Secondary School (n = 145)	1	116	80.0%
	0	29	20.0%

Note. Due to missing values on demographics questions, frequencies within groups may not add up to the total number of responses.

Plots

All plots are generated from **Model A10**.

Item Information

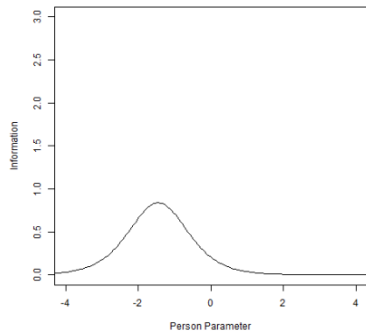

Expected Score

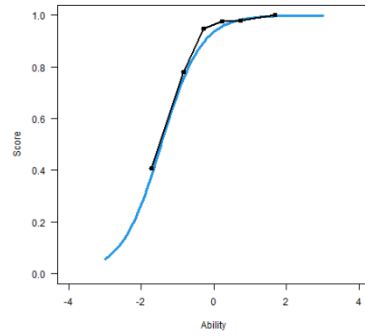

Probability

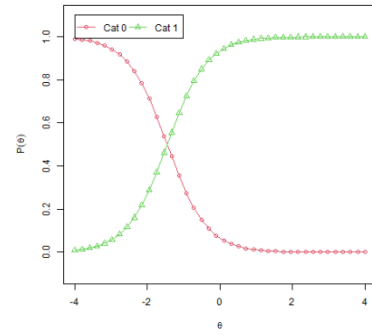

Note. The blue line represents expected performance, and the black line represents actual performance.

Note. Cat n = probability of receiving n points.

4.10.11. Concept of Linear Equation Systems (L11)

Begriff des linearen Gleichungssystems

Welche der folgenden Gleichungskombinationen sind lineare Gleichungssysteme?

Hinweis: Ein Berechnen der Systeme ist nicht nötig.

Wählen Sie eine oder mehrere richtige Antworten.

$$\begin{cases} 2x + 3y = 8 \\ \sqrt{x} - 4y = 4 \end{cases}$$

$$\begin{cases} 3x + 4y = 10 \\ x - 2y = 7 \end{cases}$$

$$\begin{cases} x + 3y = 12 \\ x^2 - 2y = 4 \end{cases}$$

$$\begin{cases} x + \frac{1}{2}y = 5 \\ 2x - y = 2 \end{cases}$$

Math Problem ID

L11

Correct Answers and Answer Frequencies

Answer	Correct Answer(s)	Number Correct Answers	Number Incorrect Answers
$\begin{cases} 2x + 3y = 8 \\ \sqrt{x} - 4y = 4 \end{cases}$	blinded	blinded	blinded
$\begin{cases} 3x + 4y = 10 \\ x - 2y = 7 \end{cases}$	blinded	blinded	blinded
$\begin{cases} x + 3y = 12 \\ x^2 - 2y = 4 \end{cases}$	blinded	blinded	blinded
$\begin{cases} x + \frac{1}{2}y = 5 \\ 2x - y = 2 \end{cases}$	blinded	blinded	blinded

Note. Scoring (PCS4): Every correct response and correct rejection is worth one point (up to 4 points possible).

Item Characteristics

Discrimination					
Measurement Type		Model A10	Model B	Model C	Model D
Correlation to participant ability (θ)		0.61	0.53	0.57	0.55
Discrimination Parameter (α)		0.78	0.65	1.02	0.75
Difficulty					
Measurement Type	Points	Model A10	Model B	Model C	Model D
Difficulty for participant of average ability level	4	-0.65	-0.83	-0.88	-0.76
	3	-1.17	-1.41	-1.46	-1.30
	2	-1.62	-1.91	-2.02	-1.77
	1	-1.91	-2.23	-2.66	-2.07
	0	NA	NA	NA	NA
Cumulative probability for participant of average ability level	4	69.9%	71.3%	77.9%	71.7%
	3	89.1%	89.6%	95.1%	90.3%
	2	97.5%	97.4%	99.4%	97.9%
	1	98.9%	98.8%	99.9%	99.1%
	0	100%	100%	100%	100%
Frequencies					
Groups	Points	Frequencies	Percent (%)		
Complete sample for this math problem (n = 528)	4	341	64.6%		
	3	87	16.5%		
	2	51	9.7%		
	1	16	3.0%		
	0	33	6.3%		
Female (n = 178)	4	111	62.4%		
	3	31	17.4%		
	2	15	8.4%		
	1	8	4.5%		
	0	13	7.3%		
Male (n = 338)	4	222	65.7%		
	3	54	16.0%		
	2	36	10.7%		
	1	8	2.4%		
	0	18	5.3%		
German as primary language at home (n = 385)	4	256	66.5%		
	3	56	14.5%		
	2	41	10.6%		
	1	9	2.3%		
	0	23	6.0%		

Frequencies			
Groups	Points	Frequencies	Percent (%)
Other language as primary language at home (n = 139)	4	83	59.7%
	3	31	22.3%
	2	10	7.2%
	1	7	5.0%
	0	8	5.8%
Secondary school completed in Germany (n = 470)	4	304	64.7%
	3	76	16.2%
	2	48	10.2%
	1	15	3.2%
	0	27	5.7%
Secondary school completed abroad (n = 55)	4	36	65.5%
	3	11	20.0%
	2	3	5.5%
	1	1	1.8%
	0	4	7.3%
Math not attended as advanced course in secondary school (n = 196)	4	95	48.5%
	3	43	21.9%
	2	30	15.3%
	1	11	5.6%
	0	17	8.7%
Math attended as advanced course in secondary school (n = 272)	4	214	78.7%
	3	32	11.8%
	2	16	5.9%
	1	3	1.1%
	0	7	2.6%
No math preparatory course attended (n = 246)	4	150	61.0%
	3	49	19.9%
	2	18	7.3%
	1	10	4.1%
	0	19	7.7%
Math preparatory course attended (n = 271)	4	186	68.6%
	3	37	13.7%
	2	31	11.4%
	1	6	2.2%
	0	11	4.1%
University of applied sciences (n = 135)	4	64	47.4%
	3	27	20.0%
	2	24	17.8%
	1	8	5.9%
	0	12	8.9%
University (n = 393)	4	277	70.5%
	3	60	15.3%
	2	27	6.9%
	1	8	2.0%
	0	21	5.3%

Frequencies			
Groups	Points	Frequencies	Percent (%)
Online Participation (n = 367)	4	231	62.9%
	3	62	16.9%
	2	37	10.1%
	1	12	3.3%
	0	25	6.8%
Pen-and-Paper Participation (n = 161)	4	110	68.3%
	3	25	15.5%
	2	14	8.7%
	1	4	2.5%
	0	8	5.0%
Attended Gymnasium (n = 370)	4	263	71.1%
	3	46	12.4%
	2	31	8.4%
	1	9	2.4%
	0	21	5.7%
Attended Other Secondary School (n = 145)	4	71	49.0%
	3	41	28.3%
	2	18	12.4%
	1	7	4.8%
	0	8	5.5%

Note. Due to missing values on demographics questions, frequencies within groups may not add up to the total number of responses.

Plots

All plots are generated from **Model A10**.

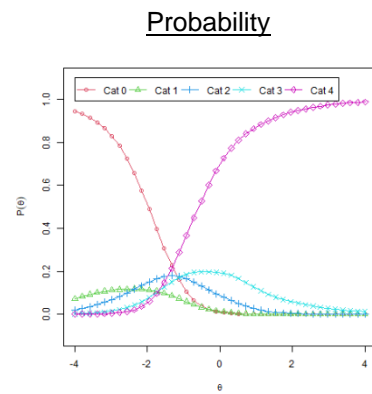
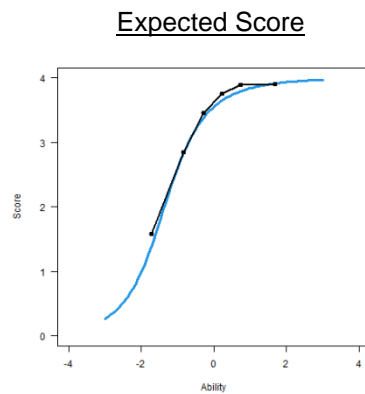
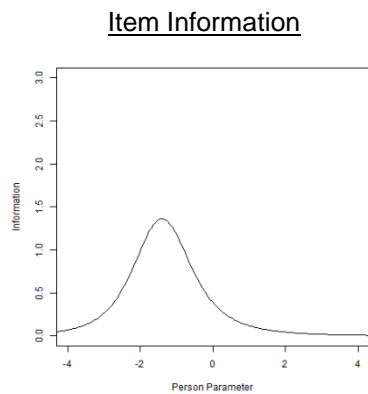

Note. The blue line represents expected performance, and the black line represents actual performance.

Note. Cat n = probability of receiving n points.

4.10.12. Linear Equation Systems for Lines (L12)

LGS einer Geraden

Gegeben sei ein lineares Gleichungssystem mit zwei Gleichungen und den Unbekannten x und y . Wenn das Gleichungssystem eine Gerade beschreibt, wie muss dann die Lösungsmenge aussehen?

Wählen Sie die richtige Antwort.

Die Lösung ist eine eindeutige Kombination von Werten für x und y .

Es gibt keine Lösung.

Die Lösung kann nur mit x in Abhängigkeit von y (oder umgekehrt) angegeben werden.

Die Lösung enthält alle Kombinationen von Werten für x und y .

Note. This problem was removed during the final revision of the scoring. The reason for the change and an overview of the psychometric properties of the problem in the previous scoring rules can be found in **Appendix 8.1**.

Math Problem ID

L12

Problem Cut

4.11. Vectors and Analytical Geometry (Vektoren und Analytische Geometrie; V)

Q₃ Statistics for Vectors and Analytical Geometry

	V1	V2	V3	V4	V5	V6	V7	V8	V9	V10	V11	V12	V13
V1	-												
V2	.083	-											
V3	-.078	-.146	-										
V4	-.017	-.023	.006	-									
V5	-.014	-.250	.404	.004	-								
V6	.000	-.052	.059	.027	.007	-							
V7	.065	-.155	.148	-.201	.363	-.067	-						
V8	-.031	-.213	.429	-.141	.627	-.074	.462	-					
V9	-.192	-.136	-.256	-.103	-.280	-.041	-.273	-.365	-				
V10	-.093	-.185	-.088	-.050	-.037	-.180	.065	-.044	-.181	-			
V11	-.040	-.288	.091	-.161	.312	-.153	.242	.360	-.232	.089	-		
V12	-.036	-.042	.255	-.075	.367	-.015	.204	.441	-.317	-.104	.117	-	
V13	.089	-.025	-.173	.111	-.236	-.060	-.247	-.302	.070	-.116	-.084	-.223	-

Note. Q₃ statistics above the critical absolute value of 0.20 are bolded. For details see **Section 3.1**.

4.11.1. Linear Combination (V1)

Linearkombination

Berechnen Sie die folgende Linearkombination für die folgenden Vektoren:

$$\vec{a} = \begin{pmatrix} 1 \\ -1 \end{pmatrix} \quad \vec{b} = \begin{pmatrix} 2 \\ 3 \end{pmatrix} \quad \vec{c} = \begin{pmatrix} 9 \\ 3 \end{pmatrix}$$

Ergänzen Sie die freien Felder.

$$2 \cdot \vec{a} - 3 \cdot \vec{b} - \vec{c} = \begin{pmatrix} \square \\ \square \end{pmatrix}$$

Math Problem ID

V1

Correct Answers and Answer Frequencies

Blank	Correct Answer(s)	Number Correct Answers	Number Incorrect Answers
1	blinded	blinded	blinded
2	blinded	blinded	blinded

Note. Scoring (PCS4): Both blanks must be correct to earn 1 point (up to 1 point possible).

Item Characteristics

Discrimination					
Measurement Type		Model A11	Model B	Model C	Model D
Correlation to participant ability (θ)		0.45	0.48	0.48	0.49
Discrimination Parameter (α)		1.07	1.33	0.87	1.23
Difficulty					
Measurement Type	Points	Model A11	Model B	Model C	Model D
Difficulty for participant of average ability level	1	-0.77	-0.60	-1.00	-0.65
	0	NA	NA	NA	NA
Cumulative probability for participant of average ability level	1	69.5%	69.0%	70.5%	69.0%
	0	100%	100%	100%	100%

Frequencies			
Groups	Points	Frequencies	Percent (%)
Complete sample for this math problem (n = 531)	1	354	66.7%
	0	177	33.3%
Female (n = 160)	1	101	63.1%
	0	59	36.9%
Male (n = 365)	1	251	68.8%
	0	114	31.2%
German as primary language at home (n = 423)	1	280	66.2%
	0	143	33.8%
Other language as primary language at home (n = 106)	1	73	68.9%
	0	33	31.1%
Secondary school completed in Germany (n = 476)	1	317	66.6%
	0	159	33.4%
Secondary school completed abroad (n = 53)	1	37	69.8%
	0	16	30.2%
Math not attended as advanced course in secondary school (n = 183)	1	90	49.2%
	0	93	50.8%
Math attended as advanced course in secondary school (n = 295)	1	230	78.0%
	0	65	22.0%
No math preparatory course attended (n = 244)	1	150	61.5%
	0	94	38.5%
Math preparatory course attended (n = 284)	1	202	71.1%
	0	82	28.9%
University of applied sciences (n = 136)	1	67	49.3%
	0	69	50.7%
University (n = 395)	1	287	72.7%
	0	108	27.3%
Online Participation (n = 356)	1	236	66.3%
	0	120	33.7%
Pen-and-Paper Participation (n = 175)	1	118	67.4%
	0	57	32.6%
Attended Gymnasium (n = 406)	1	293	72.2%
	0	113	27.8%
Attended Other Secondary School (n = 113)	1	57	50.4%
	0	56	49.6%

Note. Due to missing values on demographics questions, frequencies within groups may not add up to the total number of responses.

Plots

All plots are generated from **Model A11**.

Item Information

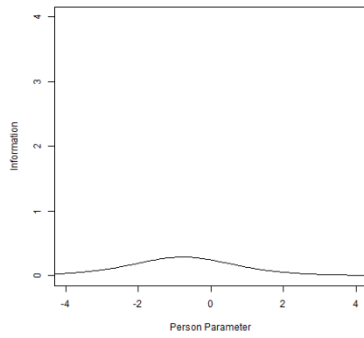

Expected Score

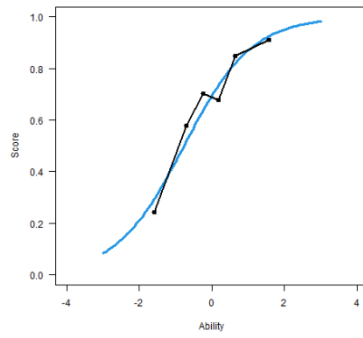

Probability

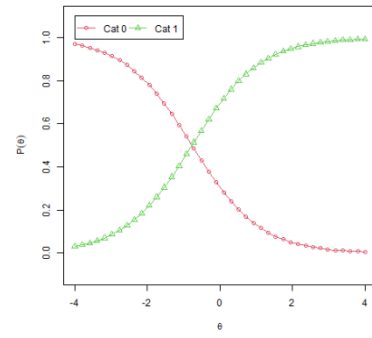

Note. The blue line represents expected performance, and the black line represents actual performance.

Note. Cat n = probability of receiving n points.

4.11.2. Vectors and Scalars (V2)

Vektor und Skalar

Die folgenden Ausdrücke beschreiben einen Vektor, eine Zahl (Skalar) oder sind nicht definiert. Dabei gilt $\vec{a}, \vec{b}, \vec{c} \in \mathbb{R}^n, r, s \in \mathbb{R}$.

Beachten Sie: "." bedeutet je nach Kontext Multiplikation oder Skalarprodukt.

Wählen Sie jeweils die richtige Antwort.

a)

$\vec{a} \cdot \vec{b} + s$

b)

$(\vec{a} + \vec{b}) \cdot \vec{c}$

c)

$\vec{a} \cdot \vec{b} + \vec{c}$

d)

$\frac{\vec{a}}{\vec{b}}$

e)

$s \cdot (r \cdot \vec{b})$

Math Problem ID

V2

Answer Options

Answer Code	Answer Text
A	Vektor
B	Zahl (Skalar)
C	nicht definiert

Correct Answers and Answer Frequencies

Math Problem Part	Correct Answer	Number Correct Answers	Number Incorrect Answers ^a	Answer Frequencies		
				A	B	C
a)	blinded	blinded	blinded	blinded	blinded	blinded
b)	blinded	blinded	blinded	blinded	blinded	blinded
c)	blinded	blinded	blinded	blinded	blinded	blinded
d)	blinded	blinded	blinded	blinded	blinded	blinded
e)	blinded	blinded	blinded	blinded	blinded	blinded

Note. Scoring (PCS4): Every correct response is worth one point (up to 5 points possible).

^a Includes cases, where the problem was seen but not answered.

Item Characteristics

Discrimination					
Measurement Type		Model A11	Model B	Model C	Model D
Correlation to participant ability (θ)		0.77	0.76	0.73	0.76
Discrimination Parameter (α)		0.94	1.06	0.57	1.10
Difficulty					
Measurement Type	Points	Model A11	Model B	Model C	Model D
Difficulty for participant of average ability level	5	1.61	1.57	2.19	1.56
	4	0.58	0.60	0.71	0.59
	3	0.11	0.14	0.06	0.14
	2	-0.26	-0.22	-0.45	-0.21
	1	-1.19	-1.09	-1.84	-1.08
	0	NA	NA	NA	NA
Cumulative probability for participant of average ability level	5	5.1%	3.9%	7.8%	3.6%
	4	21.9%	19.2%	27.0%	18.7%
	3	43.8%	41.1%	47.6%	41.0%
	2	64.0%	62.6%	65.6%	62.8%
	1	88.7%	88.8%	88.5%	89.1%
	0	100%	100%	100%	100%

Frequencies			
Groups	Points	Frequencies	Percent (%)
Complete sample for this math problem (n = 536)	5	73	13.6%
	4	103	19.2%
	3	84	15.7%
	2	70	13.1%
	1	110	20.5%
	0	96	17.9%
Female (n = 166)	5	19	11.4%
	4	26	15.7%
	3	21	12.7%
	2	30	18.1%
	1	44	26.5%
	0	26	15.7%
Male (n = 365)	5	53	14.5%
	4	76	20.8%
	3	63	17.3%
	2	40	11.0%
	1	66	18.1%
	0	67	18.4%
German as primary language at home (n = 422)	5	62	14.7%
	4	78	18.5%
	3	69	16.4%
	2	52	12.3%
	1	84	19.9%
	0	77	18.2%
Other language as primary language at home (n = 113)	5	11	9.7%
	4	25	22.1%
	3	15	13.3%
	2	18	15.9%
	1	26	23.0%
	0	18	15.9%
Secondary school completed in Germany (n = 481)	5	65	13.5%
	4	92	19.1%
	3	76	15.8%
	2	63	13.1%
	1	98	20.4%
	0	87	18.1%
Secondary school completed abroad (n = 55)	5	8	14.5%
	4	11	20.0%
	3	8	14.5%
	2	7	12.7%
	1	12	21.8%
	0	9	16.4%

Frequencies			
Groups	Points	Frequencies	Percent (%)
Math not attended as advanced course in secondary school (n = 186)	5	6	3.2%
	4	18	9.7%
	3	30	16.1%
	2	21	11.3%
	1	56	30.1%
	0	55	29.6%
Math attended as advanced course in secondary school (n = 302)	5	64	21.2%
	4	78	25.8%
	3	46	15.2%
	2	41	13.6%
	1	45	14.9%
	0	28	9.3%
No math preparatory course attended (n = 237)	5	20	8.4%
	4	45	19.0%
	3	33	13.9%
	2	41	17.3%
	1	51	21.5%
	0	47	19.8%
Math preparatory course attended (n = 297)	5	52	17.5%
	4	57	19.2%
	3	51	17.2%
	2	29	9.8%
	1	59	19.9%
	0	49	16.5%
University of applied sciences (n = 138)	5	7	5.1%
	4	10	7.2%
	3	17	12.3%
	2	22	15.9%
	1	32	23.2%
	0	50	36.2%
University (n = 398)	5	66	16.6%
	4	93	23.4%
	3	67	16.8%
	2	48	12.1%
	1	78	19.6%
	0	46	11.6%
Online Participation (n = 357)	5	52	14.6%
	4	58	16.2%
	3	57	16.0%
	2	48	13.4%
	1	82	23.0%
	0	60	16.8%

Frequencies			
Groups	Points	Frequencies	Percent (%)
Pen-and-Paper Participation (n = 179)	5	21	11.7%
	4	45	25.1%
	3	27	15.1%
	2	22	12.3%
	1	28	15.6%
	0	36	20.1%
Attended Gymnasium (n = 406)	5	63	15.5%
	4	92	22.7%
	3	65	16.0%
	2	52	12.8%
	1	78	19.2%
	0	56	13.8%
Attended Other Secondary School (n = 118)	5	10	8.5%
	4	9	7.6%
	3	18	15.3%
	2	16	13.6%
	1	28	23.7%
	0	37	31.4%

Note. Due to missing values on demographics questions, frequencies within groups may not add up to the total number of responses.

Plots

All plots are generated from **Model A11**.

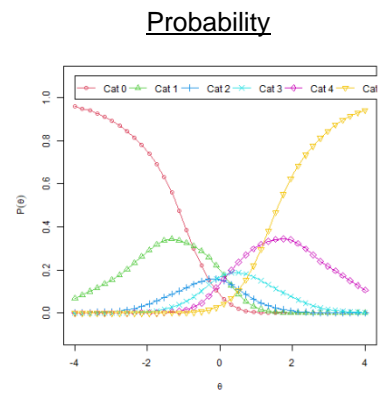
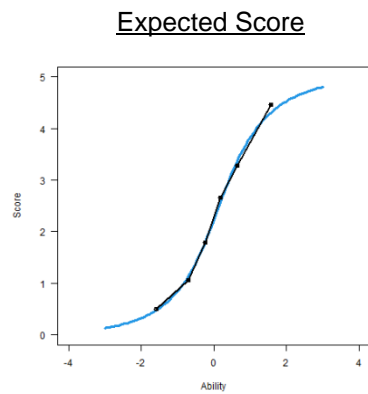
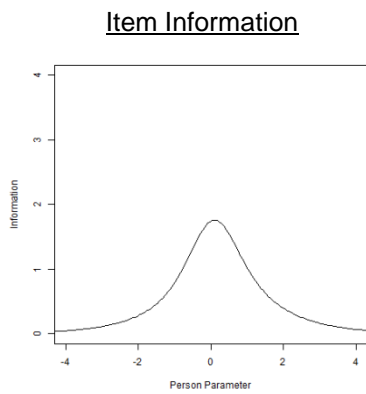

Note. The blue line represents expected performance, and the black line represents actual performance.

Note. Cat n = probability of receiving n points.

4.11.3. Calculating Scalar Products (V3)

Skalarprodukt berechnen

Berechnen Sie das Skalarprodukt der folgenden Vektoren.

$$\vec{a} = \begin{pmatrix} -8 \\ 5 \end{pmatrix} \quad \vec{b} = \begin{pmatrix} 3 \\ -4 \end{pmatrix}$$

Ergänzen Sie das freie Feld.

$\vec{a} \cdot \vec{b} =$

Math Problem ID

V3

Correct Answers and Answer Frequencies

Correct Answer(s)	Number Correct Answers	Number Incorrect Answers
blinded	blinded	blinded

Note. Scoring (PCS4): Every correct response is worth one point (up to 1 point possible).

Item Characteristics

Discrimination					
Measurement Type		Model A11	Model B	Model C	Model D
Correlation to participant ability (θ)		0.59	0.55	0.54	0.54
Discrimination Parameter (α)		1.86	1.71	1.15	1.86
Difficulty					
Measurement Type	Points	Model A11	Model B	Model C	Model D
Difficulty for participant of average ability level	1	-0.31	-0.29	-0.54	-0.27
	0	NA	NA	NA	NA
Cumulative probability for participant of average ability level	1	64.0%	62.2%	65.0%	62.5%
	0	100%	100%	100%	100%

Frequencies			
Groups	Points	Frequencies	Percent (%)
Complete sample for this math problem (n = 534)	1	327	61.2%
	0	207	38.8%
Female (n = 166)	1	103	62.0%
	0	63	38.0%
Male (n = 363)	1	222	61.2%
	0	141	38.8%
German as primary language at home (n = 420)	1	261	62.1%
	0	159	37.9%
Other language as primary language at home (n = 113)	1	65	57.5%
	0	48	42.5%
Secondary school completed in Germany (n = 467)	1	299	62.4%
	0	180	37.6%
Secondary school completed abroad (n = 55)	1	28	50.9%
	0	27	49.1%
Math not attended as advanced course in secondary school (n = 185)	1	76	41.1%
	0	109	58.9%
Math attended as advanced course in secondary school (n = 301)	1	229	76.1%
	0	72	23.9%
No math preparatory course attended (n = 237)	1	130	54.9%
	0	107	45.1%
Math preparatory course attended (n = 295)	1	195	66.1%
	0	100	33.9%
University of applied sciences (n = 138)	1	56	40.6%
	0	82	59.4%
University (n = 396)	1	271	68.4%
	0	125	31.6%
Online Participation (n = 356)	1	227	63.8%
	0	129	36.2%
Pen-and-Paper Participation (n = 178)	1	100	56.2%
	0	78	43.8%
Attended Gymnasium (n = 404)	1	269	66.6%
	0	135	33.4%
Attended Other Secondary School (n = 118)	1	54	45.8%
	0	64	54.2%

Note. Due to missing values on demographics questions, frequencies within groups may not add up to the total number of responses.

Plots

All plots are generated from **Model A11**.

Item Information

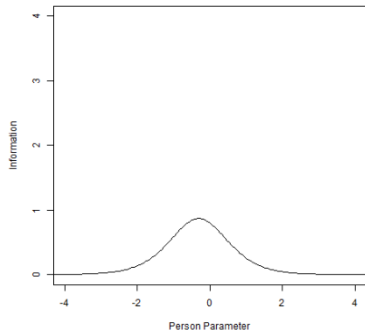

Expected Score

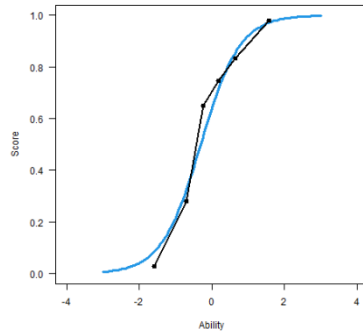

Note. The blue line represents expected performance, and the black line represents actual performance.

Probability

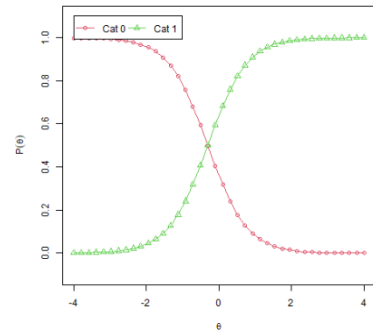

Note. Cat n = probability of receiving n points.

4.11.4. Interpreting Scalar Products (V4)

Skalarprodukt interpretieren

Seie \vec{a} , \vec{b} und \vec{c} beliebige Vektoren ungleich dem Nullvektor $\begin{pmatrix} 0 \\ 0 \\ 0 \end{pmatrix}$. Gegeben seien die Ergebnisse der folgenden Skalarprodukte:

$$\vec{a} \cdot \vec{b} = 5 \quad \vec{b} \cdot \vec{c} = 0$$

Interpretieren Sie die Lösungen, indem Sie die richtigen Antworten markieren.

Wählen Sie eine oder mehrere richtige Antworten.

\vec{b} ist orthogonal zu \vec{a} .

\vec{b} ist orthogonal zu \vec{c} .

\vec{b} und \vec{a} schließen einen spitzen Winkel ein.

\vec{b} und \vec{c} sind linear abhängig.

Math Problem ID

V4

Correct Answers and Answer Frequencies

Answer	Correct Answer(s)	Number Correct Answers	Number Incorrect Answers
\vec{b} ist orthogonal zu \vec{a} .	blinded	blinded	blinded
\vec{b} ist orthogonal zu \vec{c} .	blinded	blinded	blinded
\vec{b} und \vec{a} schließen einen spitzen Winkel ein.	blinded	blinded	blinded
\vec{b} und \vec{c} sind linear abhängig.	blinded	blinded	blinded

Note. Scoring (PCS4): All answer options must be correctly chosen or correctly rejected to earn one point (up to 1 point possible).

Item Characteristics

Discrimination					
Measurement Type		Model A11	Model B	Model C	Model D
Correlation to participant ability (θ)		0.36	0.33	0.32	0.32
Discrimination Parameter (α)		0.81	0.79	0.47	0.81
Difficulty					
Measurement Type	Points	Model A11	Model B	Model C	Model D
Difficulty for participant of average ability level	1	1.19	1.25	1.84	1.22
	0	NA	NA	NA	NA
Cumulative probability for participant of average ability level	1	27.6%	27.2%	29.8%	27.0%
	0	100%	100%	100%	100%
Frequencies					
Groups	Points	Frequencies		Percent (%)	
Complete sample for this math problem (n = 530)	1	164		30.9%	
	0	366		69.1%	
Female (n = 164)	1	38		23.2%	
	0	126		76.8%	
Male (n = 361)	1	125		34.6%	
	0	236		65.4%	
German as primary language at home (n = 417)	1	124		29.7%	
	0	293		70.3%	
Other language as primary language at home (n = 112)	1	40		35.7%	
	0	72		64.3%	
Secondary school completed in Germany (n = 475)	1	143		30.1%	
	0	332		69.9%	
Secondary school completed abroad (n = 55)	1	21		38.2%	
	0	34		61.8%	
Math not attended as advanced course in secondary school (n = 182)	1	35		19.2%	
	0	147		80.8%	
Math attended as advanced course in secondary school (n = 300)	1	115		38.3%	
	0	185		61.7%	
No math preparatory course attended (n = 236)	1	68		28.8%	
	0	168		71.2%	
Math preparatory course attended (n = 292)	1	95		32.5%	
	0	197		67.5%	
University of applied sciences (n = 137)	1	27		19.7%	
	0	110		80.3%	
University (n = 393)	1	137		34.9%	
	0	256		65.1%	
Online Participation (n = 352)	1	111		31.5%	
	0	241		68.5%	
Pen-and-Paper Participation (n = 178)	1	53		29.8%	
	0	125		70.2%	

Frequencies			
Groups	Points	Frequencies	Percent (%)
Attended Gymnasium (n = 400)	1	134	33.5%
	0	266	66.5%
Attended Other Secondary School (n = 118)	1	28	23.7%
	0	90	76.3%

Note. Due to missing values on demographics questions, frequencies within groups may not add up to the total number of responses.

Plots

All plots are generated from **Model A11**.

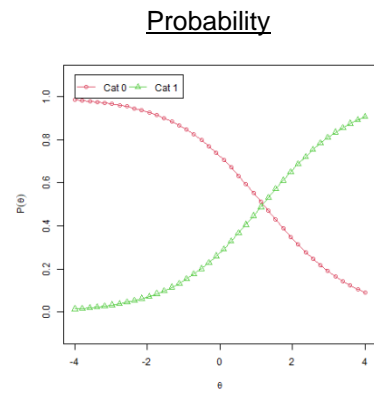
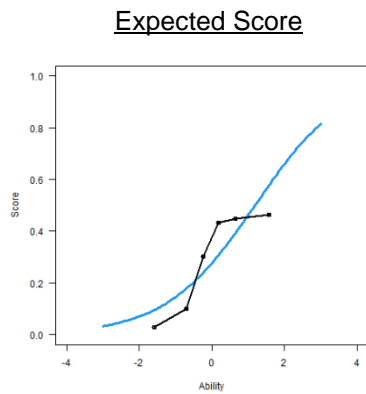
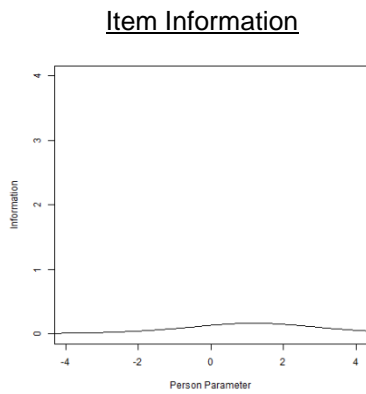

Note. The blue line represents expected performance, and the black line represents actual performance.

Note. Cat n = probability of receiving n points.

4.11.5. Normal Vector (V5)

Version 1:

Normalenvektor

Geben Sie zu der folgenden Ebene E einen Normalenvektor \vec{n} an.

Ergänzen Sie die freien Felder.

$$E : \vec{x} = \begin{pmatrix} 1 \\ 2 \\ 3 \end{pmatrix} + \lambda \cdot \begin{pmatrix} -1 \\ 5 \\ 0 \end{pmatrix} + \mu \cdot \begin{pmatrix} 0 \\ -1 \\ 1 \end{pmatrix}; \lambda, \mu \in \mathbb{R}.$$
$$\vec{n} = \begin{pmatrix} \square \\ \square \\ \square \end{pmatrix}$$

Version 2:

Normalenvektor

Ergänzen Sie die Einträge von \vec{n} so, dass \vec{n} ein Normalenvektor der Ebene E ist.

Ergänzen Sie die freien Felder.

$$E : \vec{x} = \begin{pmatrix} 1 \\ 2 \\ 3 \end{pmatrix} + \lambda \cdot \begin{pmatrix} -1 \\ 5 \\ 0 \end{pmatrix} + \mu \cdot \begin{pmatrix} 0 \\ -1 \\ 1 \end{pmatrix}; \lambda, \mu \in \mathbb{R}.$$
$$\vec{n} = \begin{pmatrix} \square \\ 1 \\ \square \end{pmatrix}$$

Math Problem ID

V5

Correct Answers and Answer Frequencies

Version 1:

Blank	Correct Answer(s)	Number Correct Answers	Number Incorrect Answers
1	blinded	blinded	blinded
2	blinded	blinded	blinded
3	blinded	blinded	blinded

Note. Scoring (PCS4): All blanks must be correct to earn 1 point (up to 1 point possible).

Version 2:

Blank	Correct Answer(s)	Number Correct Answers	Number Incorrect Answers
1	blinded	blinded	blinded
2	blinded	blinded	blinded

Note. Scoring (PCS4): Both blanks must be correct to earn 1 point (up to 1 point possible).

Item Characteristics

Discrimination					
Measurement Type		Model A11	Model B	Model C	Model D
Correlation to participant ability (θ)		0.69	0.62	0.60	0.61
Discrimination Parameter (α)		2.80	2.27	1.46	2.67
Difficulty					
Measurement Type	Points	Model A11	Model B	Model C	Model D
Difficulty for participant of average ability level	1	0.63	0.72	0.84	0.68
	0	NA	NA	NA	NA
Cumulative probability for participant of average ability level	1	14.6%	16.5%	22.8%	14.0%
	0	100%	100%	100%	100%
Frequencies					
Groups	Points	Frequencies		Percent (%)	
Complete sample for this math problem (n = 529)	1	162		30.6%	
	0	367		69.4%	
Female (n = 159)	1	42		26.4%	
	0	117		73.6%	
Male (n = 364)	1	119		32.7%	
	0	245		67.3%	
German as primary language at home (n = 421)	1	137		32.5%	
	0	284		67.5%	
Other language as primary language at home (n = 106)	1	25		23.6%	
	0	81		76.4%	
Secondary school completed in Germany (n = 474)	1	154		32.5%	
	0	320		67.5%	
Secondary school completed abroad (n = 53)	1	8		15.1%	
	0	45		84.9%	

Frequencies				
Groups	Points	Frequencies	Percent (%)	
Math not attended as advanced course in secondary school (n = 181)	1	12	6.6%	
	0	169	93.4%	
Math attended as advanced course in secondary school (n = 295)	1	138	46.8%	
	0	157	53.2%	
No math preparatory course attended (n = 242)	1	59	24.4%	
	0	183	75.6%	
Math preparatory course attended (n = 284)	1	102	35.9%	
	0	182	64.1%	
University of applied sciences (n = 135)	1	20	14.8%	
	0	115	85.2%	
University (n = 394)	1	142	36.0%	
	0	252	64.0%	
Online Participation (n = 355)	1	109	30.7%	
	0	246	69.3%	
Pen-and-Paper Participation (n = 174)	1	53	30.5%	
	0	121	69.5%	
Attended Gymnasium (n = 406)	1	141	34.7%	
	0	265	65.3%	
Attended Other Secondary School (n = 111)	1	17	15.3%	
	0	94	84.7%	

Note. Due to missing values on demographics questions, frequencies within groups may not add up to the total number of responses.

Plots

All plots are generated from **Model A11**.

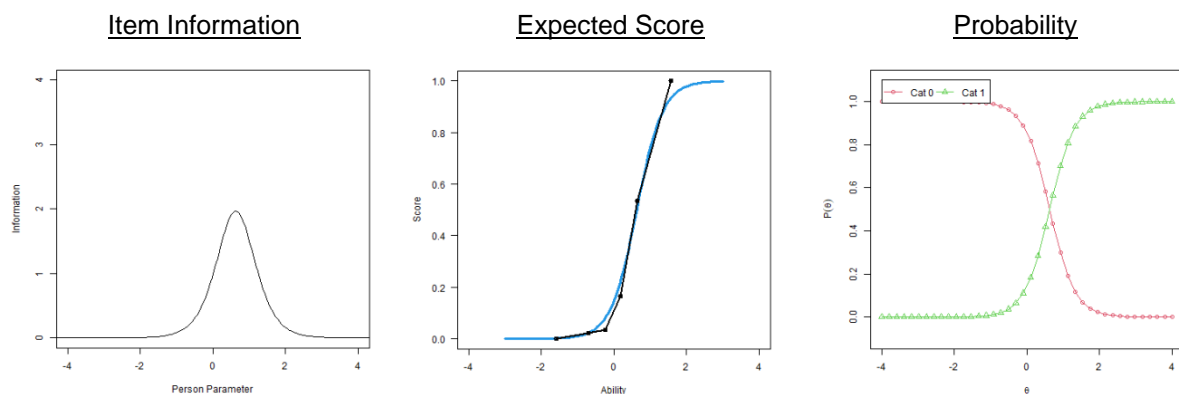

Note. The blue line represents expected performance, and the black line represents actual performance.

Note. Cat n = probability of receiving n points.

4.11.6. Angle Between two Lines (V6)

Winkel zwischen zwei Geraden

Die beiden Geraden g_1 und g_2 schneiden sich in einem Punkt, φ beschreibt den Winkel zwischen den Geraden.

$$g_1 : \vec{x} = \vec{a} + \lambda \cdot \vec{u} \quad \text{mit } \vec{a}, \vec{u} \in \mathbb{R}^2, \lambda \in \mathbb{R}.$$

$$g_2 : \vec{x} = \vec{b} + \mu \cdot \vec{v} \quad \text{mit } \vec{b}, \vec{v} \in \mathbb{R}^2, \mu \in \mathbb{R}.$$

Wählen Sie die allgemein gültige Formel zur Berechnung von $\cos(\varphi)$ aus.

Beachten Sie: "." bedeutet je nach Kontext Multiplikation oder Skalarprodukt.

$\cos(\varphi) =$

A

$$\frac{|\vec{u}| \cdot |\vec{v}|}{|\vec{u} \cdot \vec{v}|}$$

B

$$|\vec{u} \cdot \vec{v}|$$

C

$$\frac{|\vec{u} \cdot \vec{v}|}{|\vec{u}| \cdot |\vec{v}|}$$

D

$$|\vec{u}| \cdot |\vec{v}|$$

Math Problem ID

V6

Correct Answers and Answer Frequencies

Correct Answer	Number Correct Answers	Number Incorrect Answers ^a	Answer Frequencies			
			A	B	C	D
blinded	blinded	blinded	blinded	blinded	blinded	blinded

Note. Scoring (PCS4): Every correct response is worth one point (up to 1 point possible).

^a Includes cases, where the problem was seen but not answered.

Item Characteristics

Discrimination					
Measurement Type		Model A11	Model B	Model C	Model D
Correlation to participant ability (θ)		0.45	0.42	0.40	0.41
Discrimination Parameter (α)		1.08	1.04	0.64	1.08
Difficulty					
Measurement Type	Points	Model A11	Model B	Model C	Model D
Difficulty for participant of average ability level	1	-0.22	-0.19	-0.44	-0.18
	0	NA	NA	NA	NA
Cumulative probability for participant of average ability level	1	55.8%	54.9%	57.1%	54.8%
	0	100%	100%	100%	100%

Frequencies			
Groups	Points	Frequencies	Percent (%)
Complete sample for this math problem (n = 528)	1	297	56.2%
	0	231	43.8%
Female (n = 164)	1	90	54.9%
	0	74	45.1%
Male (n = 359)	1	205	57.1%
	0	154	42.9%
German as primary language at home (n = 415)	1	228	54.9%
	0	187	45.1%
Other language as primary language at home (n = 112)	1	69	61.6%
	0	43	38.4%
Secondary school completed in Germany (n = 473)	1	262	55.4%
	0	211	44.6%
Secondary school completed abroad (n = 55)	1	35	63.6%
	0	20	36.4%
Math not attended as advanced course in secondary school (n = 180)	1	76	42.2%
	0	104	57.8%
Math attended as advanced course in secondary school (n = 300)	1	195	65.0%
	0	105	35.0%
No math preparatory course attended (n = 235)	1	131	55.7%
	0	104	44.3%
Math preparatory course attended (n = 291)	1	164	56.4%
	0	127	43.6%
University of applied sciences (n = 135)	1	45	33.3%
	0	90	66.7%
University (n = 393)	1	252	64.1%
	0	141	35.9%
Online Participation (n = 350)	1	203	58.0%
	0	147	42.0%
Pen-and-Paper Participation (n = 178)	1	94	52.8%
	0	84	47.2%
Attended Gymnasium (n = 399)	1	237	59.4%
	0	162	40.6%
Attended Other Secondary School (n = 117)	1	54	46.2%
	0	63	53.8%

Note. Due to missing values on demographics questions, frequencies within groups may not add up to the total number of responses.

Plots

All plots are generated from **Model A11**.

Item Information

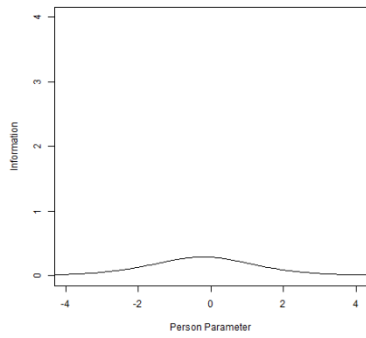

Expected Score

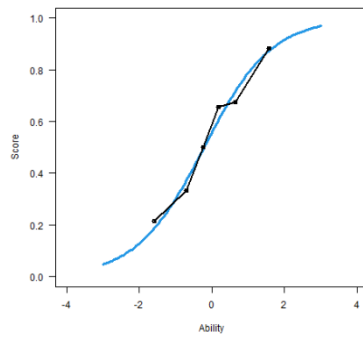

Probability

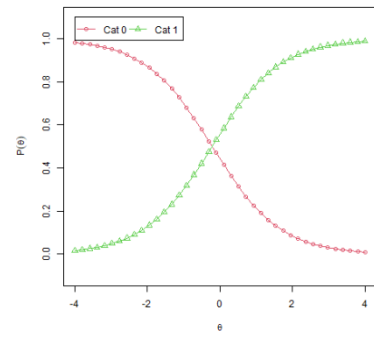

Note. The blue line represents expected performance, and the black line represents actual performance.

Note. Cat n = probability of receiving n points.

4.11.7. Reading a Position Vector (V7)

Version 1:

Ortsvektoren ablesen

Gegeben sind ein Würfel mit Kantenlänge 2 und eine Gerade g , die den Würfel in den Punkten A und B schneidet, wie abgebildet. Punkt A ist der Mittelpunkt der Grundfläche, Punkt B der Mittelpunkt der Würfelkante.

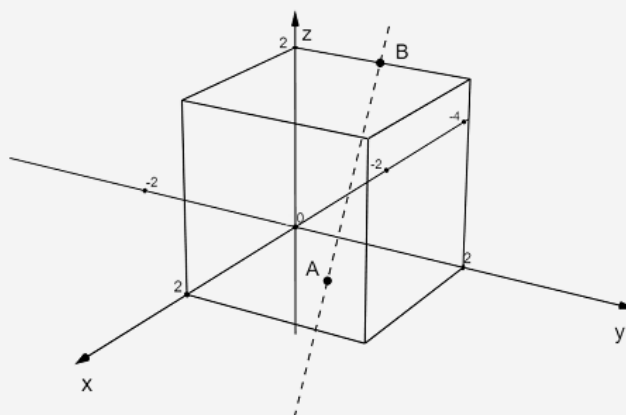

Bestimmen Sie die Ortsvektoren von A und B .

Ergänzen Sie die freien Felder.

$$\vec{OA} = \begin{pmatrix} \square \\ \square \\ \square \end{pmatrix} \quad \vec{OB} = \begin{pmatrix} \square \\ \square \\ \square \end{pmatrix}$$

Version 2:

Ortsvektoren ablesen

Auf dem dargestellten Würfel liegt der Punkt A genau in der Mitte der zugehörigen Kante.

Geben Sie den Ortsvektor von A an.

Ergänzen Sie die freien Felder.

$$\vec{OA} = \begin{pmatrix} \square \\ \square \\ \square \end{pmatrix}$$

Math Problem ID

V7

Correct Answers and Answer Frequencies

Version 1:

Blank	Correct Answer(s)	Number Correct Answers	Number Incorrect Answers
1	blinded	blinded	blinded
2	blinded	blinded	blinded
3	blinded	blinded	blinded
4	blinded	blinded	blinded
5	blinded	blinded	blinded
6	blinded	blinded	blinded

Note. Blanks are numbered from left to right and then from top to bottom. Thus, odd blanks reflect the first vector and even blanks reflect the second vector. Scoring (PCS4): To combine with later versions, the second vector is dropped. Therefore, correct responses to the first vector (Blanks 1, 3, and 5) are worth one point combined (up to 1 point possible).

Version 2:

Blank	Correct Answer(s)	Number Correct Answers	Number Incorrect Answers
1	blinded	blinded	blinded
2	blinded	blinded	blinded
3	blinded	blinded	blinded

Note. Scoring (PCS4): All blanks must be correct to earn 1 point (up to 1 point possible).

Item Characteristics

Discrimination					
Measurement Type		Model A11	Model B	Model C	Model D
Correlation to participant ability (θ)		0.56	0.53	0.52	0.53
Discrimination Parameter (α)		1.95	1.93	1.22	2.04
Difficulty					
Measurement Type	Points	Model A11	Model B	Model C	Model D
Difficulty for participant of average ability level	1	-0.78	-0.75	-1.20	-0.73
	0	NA	NA	NA	NA
Cumulative probability for participant of average ability level	1	82.1%	80.9%	81.1%	81.5%
	0	100%	100%	100%	100%
Frequencies					
Groups	Points	Frequencies		Percent (%)	
Complete sample for this math problem (n = 528)	1	392		74.2%	
	0	136		25.8%	
Female (n = 164)	1	104		63.4%	
	0	60		36.6%	
Male (n = 359)	1	284		79.1%	
	0	75		20.9%	
German as primary language at home (n = 415)	1	319		76.9%	
	0	96		23.1%	
Other language as primary language at home (n = 112)	1	72		64.3%	
	0	40		35.7%	
Secondary school completed in Germany (n = 473)	1	359		75.9%	
	0	114		24.1%	
Secondary school completed abroad (n = 55)	1	33		60.0%	
	0	22		40.0%	
Math not attended as advanced course in secondary school (n = 180)	1	101		56.1%	
	0	79		43.9%	
Math attended as advanced course in secondary school (n = 300)	1	262		87.3%	
	0	38		12.7%	
No math preparatory course attended (n = 235)	1	162		68.9%	
	0	73		31.1%	

Frequencies			
Groups	Points	Frequencies	Percent (%)
Math preparatory course attended (n = 291)	1	228	78.4%
	0	63	21.6%
University of applied sciences (n = 135)	1	72	53.3%
	0	63	46.7%
University (n = 393)	1	320	81.4%
	0	73	18.6%
Online Participation (n = 350)	1	256	73.1%
	0	94	26.9%
Pen-and-Paper Participation (n = 178)	1	136	76.4%
	0	42	23.6%
Attended Gymnasium (n = 399)	1	318	79.7%
	0	81	20.3%
Attended Other Secondary School (n = 117)	1	68	58.1%
	0	49	41.9%

Note. Due to missing values on demographics questions, frequencies within groups may not add up to the total number of responses.

Plots

All plots are generated from **Model A11**.

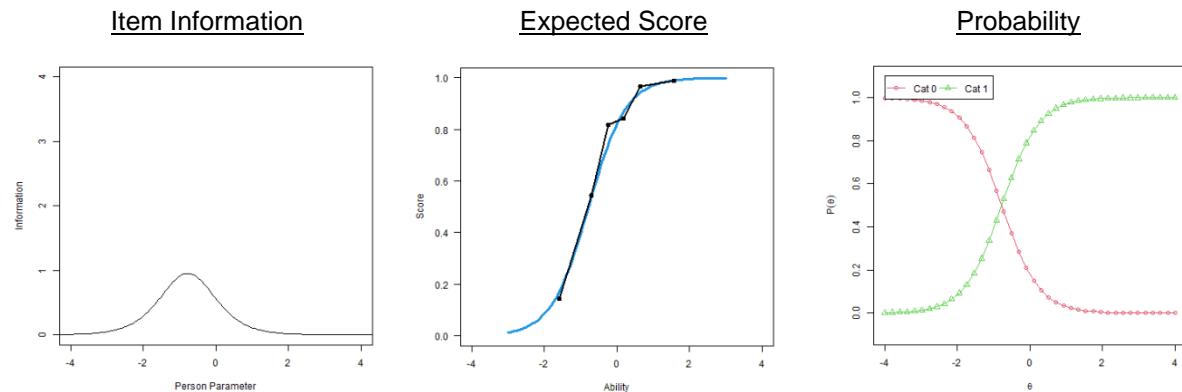

Note. The blue line represents expected performance, and the black line represents actual performance.

Note. Cat n = probability of receiving n points.

4.11.8. Linking Vector and Length of a Vector (V8)

Verbindungsvektor und Länge eines Vektors

Gegeben seien die Punkte A und B , die in der x-y-Ebene liegen:

$$A = (1|1) \quad B = (2|3)$$

Bestimmen Sie den Verbindungsvektor von A zu B und berechnen Sie anschließend seine Länge.

Ergänzen Sie die freien Felder.

Beachten Sie: Wurzel x wird als sqrt(x) eingegeben.

$$\vec{AB} = \begin{pmatrix} \square \\ \square \end{pmatrix}$$

$$|\vec{AB}| = \square$$

Math Problem ID

V8

Correct Answers and Answer Frequencies

Blank	Correct Answer(s)	Number Correct Answers	Number Incorrect Answers
1	blinded	blinded	blinded
2	blinded	blinded	blinded
3	blinded	blinded	blinded

Note. Scoring (PCS4): Blanks 1 and 2 must be answered correctly to earn one point. Correctly answering Blank 3 is worth one point (up to 2 points possible).

Item Characteristics

Discrimination					
Measurement Type		Model A11	Model B	Model C	Model D
Correlation to participant ability (θ)		0.75	0.69	0.67	0.68
Discrimination Parameter (α)		2.31	1.83	1.16	2.25
Difficulty					
Measurement Type	Points	Model A11	Model B	Model C	Model D
Difficulty for participant of average ability level	2	-0.32	-0.27	-0.48	-0.27
	1	-0.74	-0.70	-1.09	-0.68
	0	NA	NA	NA	NA
Cumulative probability for participant of average ability level	2	72.1%	66.3%	69.0%	68.9%
	1	93.7%	88.6%	88.8%	91.9%
	0	100%	100%	100%	100%
Frequencies					
Groups	Points	Frequencies		Percent (%)	
Complete sample for this math problem (n = 526)	2	320		60.8%	
	1	81		15.4%	
	0	125		23.8%	
Female (n = 158)	2	83		52.5%	
	1	29		18.4%	
	0	46		29.1%	
Male (n = 362)	2	235		64.9%	
	1	52		14.4%	
	0	75		20.7%	
German as primary language at home (n = 420)	2	261		62.1%	
	1	65		15.5%	
	0	94		22.4%	
Other language as primary language at home (n = 104)	2	58		55.8%	
	1	16		15.4%	
	0	30		28.8%	
Secondary school completed in Germany (n = 471)	2	295		62.6%	
	1	67		14.2%	
	0	109		23.1%	
Secondary school completed abroad (n = 53)	2	25		47.2%	
	1	14		26.4%	
	0	14		26.4%	
Math not attended as advanced course in secondary school (n = 180)	2	64		35.6%	
	1	38		21.1%	
	0	78		43.3%	
Math attended as advanced course in secondary school (n = 293)	2	232		79.2%	
	1	33		11.3%	
	0	28		9.6%	

Frequencies			
Groups	Points	Frequencies	Percent (%)
No math preparatory course attended (n = 240)	2	137	57.1%
	1	36	15.0%
	0	67	27.9%
Math preparatory course attended (n = 283)	2	182	64.3%
	1	45	15.9%
	0	56	19.8%
University of applied sciences (n = 133)	2	51	38.3%
	1	25	18.8%
	0	57	42.9%
University (n = 393)	2	269	68.4%
	1	56	14.2%
	0	68	17.3%
Online Participation (n = 352)	2	219	62.2%
	1	46	13.1%
	0	87	24.7%
Pen-and-Paper Participation (n = 174)	2	101	58.0%
	1	35	20.1%
	0	38	21.8%
Attended Gymnasium (n = 404)	2	263	65.1%
	1	62	15.3%
	0	79	19.6%
Attended Other Secondary School (n = 110)	2	52	47.3%
	1	16	14.5%
	0	42	38.2%

Note. Due to missing values on demographics questions, frequencies within groups may not add up to the total number of responses.

Plots

All plots are generated from **Model A11**.

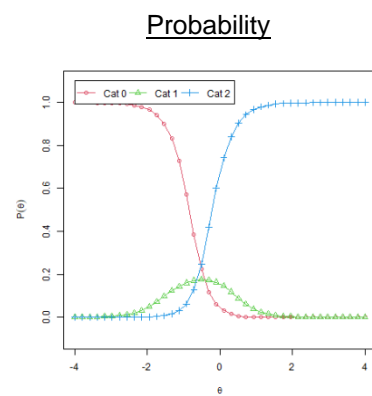
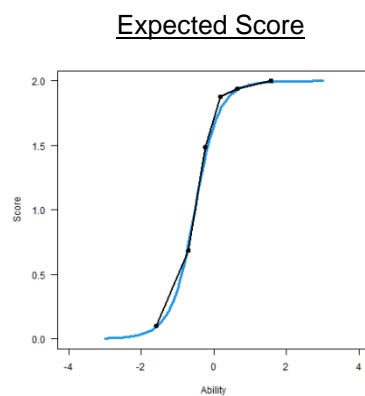
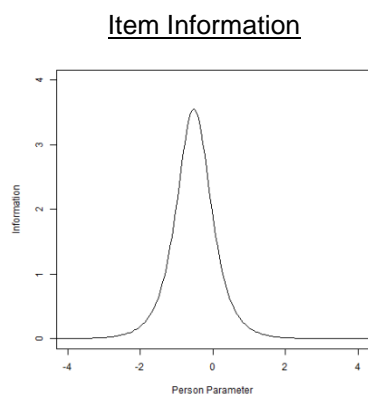

Note. The blue line represents expected performance, and the black line represents actual performance.

Note. Cat n = probability of receiving n points.

4.11.9. Position Problems (V9)

Lageprobleme

Gegeben sind zwei Geraden g_1 und g_2 mit

$$\begin{aligned} g_1 : \vec{x} &= \vec{a} + \lambda \cdot \vec{u} && \text{mit } \vec{a}, \vec{u} \in \mathbb{R}^2, \lambda \in \mathbb{R}. \\ g_2 : \vec{x} &= \vec{b} + \mu \cdot \vec{v} && \text{mit } \vec{b}, \vec{v} \in \mathbb{R}^2, \mu \in \mathbb{R}. \end{aligned}$$

Entscheiden Sie, welche der Aussagen in jedem Fall wahr ist.

Wählen Sie jeweils eine oder mehrere richtige Antworten.

a)

g_1 und g_2 sind parallel oder identisch, wenn...

... \vec{u} und \vec{v} kollinear sind.

... \vec{a} und \vec{b} kollinear sind.

...die Gleichung $\vec{a} = \vec{b} + \mu \cdot \vec{v}$ eine Lösung hat.

b)

Wie können g_1 und g_2 zueinander liegen, wenn das durch Gleichsetzen entstehende Gleichungssystem keine Lösung besitzt?

Die Geraden sind windschief.

Die Geraden sind identisch.

Die Geraden schneiden sich in genau einem Punkt.

Die Geraden sind parallel zueinander, aber nicht identisch.

Math Problem ID

V9

Changes to the Problem After the Main Study

This problem was changed after the main study. The reason for the implemented changes and results of qualitative interviews testing the revised version are reported in **Section 5**.

Correct Answers and Answer Frequencies

Math Problem Part	Answer	Correct Answer(s)	Number Correct Answers	Number Incorrect Answers
a)	... \vec{u} und \vec{v} kollinear sind.	blinded	blinded	blinded
	... \vec{u} und \vec{v} kollinear sind.	blinded	blinded	blinded
	... die Gleichung $\vec{a} = \vec{b} + \mu * \vec{v}$ eine Lösung hat.	blinded	blinded	blinded
b)	Die Geraden sind windschief.	blinded	blinded	blinded
	Die Geraden sind identisch.	blinded	blinded	blinded
	Die Geraden schneiden sich in einem Punkt.	blinded	blinded	blinded
	Die Geraden sind parallel zueinander, aber nicht identisch.	blinded	blinded	blinded

Note. Scoring (PCS4): Every correct response and correct rejection is worth one point (up to 7 points possible).

Item Characteristics

Discrimination					
Measurement Type		Model A11	Model B	Model C	Model D
Correlation to participant ability (θ)		0.76	0.66	0.64	0.65
Discrimination Parameter (α)		0.78	0.55	0.42	0.72
Difficulty					
Measurement Type	Points	Model A11	Model B	Model C	Model D
Difficulty for participant of average ability level	7	0.91	1.12	1.32	0.98
	6	-0.07	-0.03	-0.14	-0.03
	5	-0.43	-0.41	-0.69	-0.39
	4	-0.94	-0.93	-1.45	-0.89
	3	-1.09	-1.09	-1.91	-1.04
	2	-1.24	-1.26	-2.45	-1.19
	1	-1.32	-1.36	-3.39	-1.28
	0	NA	NA	NA	NA
Cumulative probability for participant of average ability level	7	22.5%	23.3%	25.8%	21.8%
	6	53.3%	51.2%	53.8%	51.3%
	5	70.6%	66.7%	69.7%	68.2%
	4	92.5%	88.2%	88.2%	90.8%
	3	96.7%	93.2%	94.8%	95.5%
	2	98.6%	96.0%	97.9%	97.8%
	1	98.9%	96.7%	99.3%	98.3%
	0	100%	100%	100%	100%

Frequencies			
Groups	Points	Frequencies	Percent (%)
Complete sample for this math problem (n = 522)	7	144	27.6%
	6	125	23.9%
	5	60	11.5%
	4	85	16.3%
	3	23	4.4%
	2	18	3.4%
	1	7	1.3%
	0	60	11.5%
Female (n = 157)	7	37	23.6%
	6	36	22.9%
	5	18	11.5%
	4	36	22.9%
	3	7	4.5%
	2	7	4.5%
	1	0	0.0%
	0	16	10.2%
Male (n = 359)	7	106	29.5%
	6	88	24.5%
	5	42	11.7%
	4	49	13.6%
	3	16	4.5%
	2	11	3.1%
	1	7	1.9%
	0	40	11.1%
German as primary language at home (n = 417)	7	128	30.7%
	6	103	24.7%
	5	53	12.7%
	4	59	14.1%
	3	18	4.3%
	2	10	2.4%
	1	4	1.0%
	0	42	10.1%
Other language as primary language at home (n = 103)	7	16	15.5%
	6	22	21.4%
	5	7	6.8%
	4	25	24.3%
	3	5	4.9%
	2	8	7.8%
	1	3	2.9%
	0	17	16.5%

Frequencies			
Groups	Points	Frequencies	Percent (%)
Secondary school completed in Germany (n = 467)	7	141	30.2%
	6	114	24.4%
	5	55	11.8%
	4	68	14.6%
	3	21	4.5%
	2	13	2.8%
	1	5	1.1%
	0	50	10.7%
Secondary school completed abroad (n = 53)	7	3	5.7%
	6	11	20.8%
	5	5	9.4%
	4	17	32.1%
	3	2	3.8%
	2	5	9.4%
	1	2	3.8%
	0	8	15.1%
Math not attended as advanced course in secondary school (n = 178)	7	17	9.6%
	6	40	22.5%
	5	23	12.9%
	4	40	22.5%
	3	12	6.7%
	2	15	8.4%
	1	2	1.1%
	0	29	16.3%
Math attended as advanced course in secondary school (n = 292)	7	123	42.1%
	6	74	25.3%
	5	31	10.6%
	4	35	12.0%
	3	9	3.1%
	2	2	0.7%
	1	1	0.3%
	0	17	5.8%
No math preparatory course attended (n = 239)	7	52	21.8%
	6	58	24.3%
	5	27	11.3%
	4	45	18.8%
	3	12	5.0%
	2	11	4.6%
	1	3	1.3%
	0	31	13.0%

Frequencies			
Groups	Points	Frequencies	Percent (%)
Math preparatory course attended (n = 280)	7	92	32.9%
	6	66	23.6%
	5	33	11.8%
	4	40	14.3%
	3	11	3.9%
	2	7	2.5%
	1	4	1.4%
	0	27	9.6%
University of applied sciences (n = 131)	7	22	16.8%
	6	20	15.3%
	5	17	13.0%
	4	26	19.8%
	3	3	2.3%
	2	11	8.4%
	1	3	2.3%
	0	29	22.1%
University (n = 391)	7	122	31.2%
	6	105	26.9%
	5	43	11.0%
	4	59	15.1%
	3	20	5.1%
	2	7	1.8%
	1	4	1.0%
	0	31	7.9%
Online Participation (n = 348)	7	88	25.3%
	6	88	25.3%
	5	28	8.0%
	4	65	18.7%
	3	16	4.6%
	2	13	3.7%
	1	6	1.7%
	0	44	12.6%
Pen-and-Paper Participation (n = 174)	7	56	32.2%
	6	37	21.3%
	5	32	18.4%
	4	20	11.5%
	3	7	4.0%
	2	5	2.9%
	1	1	0.6%
	0	16	9.2%

Frequencies			
Groups	Points	Frequencies	Percent (%)
Attended Gymnasium (n = 402)	7	133	33.1%
	6	92	22.9%
	5	50	12.4%
	4	59	14.7%
	3	20	5.0%
	2	9	2.2%
	1	2	0.5%
	0	37	9.2%
Attended Other Secondary School (n = 108)	7	11	10.2%
	6	30	27.8%
	5	8	7.4%
	4	23	21.3%
	3	3	2.8%
	2	8	7.4%
	1	5	4.6%
	0	20	18.5%

Note. Due to missing values on demographics questions, frequencies within groups may not add up to the total number of responses.

Plots

All plots are generated from **Model A11**.

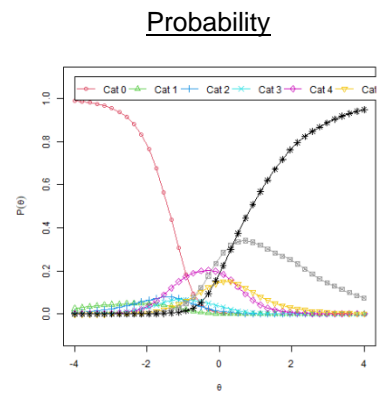
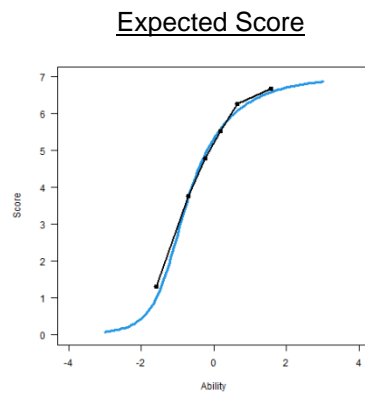
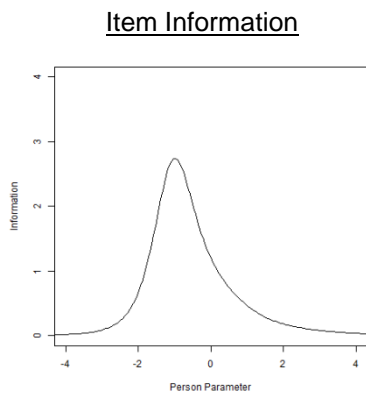

Note. The blue line represents expected performance, and the black line represents actual performance.

Note. Cat n = probability of receiving n points.

4.11.10. Determination of a Plane (V10)

Festlegung einer Ebene

Entscheiden Sie, durch welche der folgenden Situationen eine Ebene eindeutig festgelegt wird.

Wählen Sie eine oder mehrere richtige Antworten.

Drei Punkte auf der Ebene, die auf einer Geraden liegen.

Drei Punkte auf der Ebene, die ein Dreieck aufspannen.

Zwei verschiedene Geraden in der Ebene, die sich schneiden.

Eine Gerade, die in der Ebene liegt.

Math Problem ID

V10

Correct Answers and Answer Frequencies

Answer	Correct Answer(s)	Number Correct Answers	Number Incorrect Answers
Drei Punkte auf der Ebene, die auf einer Geraden liegen.	blinded	blinded	blinded
Drei Punkte auf der Ebene, die ein Dreieck aufspannen.	blinded	blinded	blinded
Zwei verschiedene Geraden in der Ebene, die sich schneiden.	blinded	blinded	blinded
Eine Gerade, die in der Ebene liegt.	blinded	blinded	blinded

Note. Scoring (PCS4): Every correct response and correct rejection is worth one point (up to 4 points possible).

Item Characteristics

Discrimination					
Measurement Type		Model A11	Model B	Model C	Model D
Correlation to participant ability (θ)		0.66	0.59	0.58	0.59
Discrimination Parameter (α)		1.11	0.93	0.71	1.10
Difficulty					
Measurement Type	Points	Model A11	Model B	Model C	Model D
Difficulty for participant of average ability level	4	-0.40	-0.39	-0.63	-0.36
	3	-0.92	-0.94	-1.38	-0.89
	2	-1.27	-1.28	-2.03	-1.22
	1	-1.81	-1.83	-3.31	-1.75
	0	NA	NA	NA	NA
Cumulative probability for participant of average ability level	4	66.0%	64.3%	66.6%	64.8%
	3	90.1%	87.9%	88.8%	89.4%
	2	97.3%	96.0%	97.0%	97.0%
	1	99.5%	99.0%	99.6%	99.4%
	0	100%	100%	100%	100%
Frequencies					
Groups	Points	Frequencies	Percent (%)		
Complete sample for this math problem (n = 538)	4	327	60.8%		
	3	99	18.4%		
	2	45	8.4%		
	1	34	6.3%		
	0	33	6.1%		
Female (n = 167)	4	77	46.1%		
	3	41	24.6%		
	2	22	13.2%		
	1	16	9.6%		
	0	11	6.6%		
Male (n = 366)	4	247	67.5%		
	3	58	15.8%		
	2	23	6.3%		
	1	18	4.9%		
	0	20	5.5%		
German as primary language at home (n = 422)	4	273	64.7%		
	3	70	16.6%		
	2	33	7.8%		
	1	29	6.9%		
	0	17	4.0%		

Frequencies			
Groups	Points	Frequencies	Percent (%)
Other language as primary language at home (n = 115)	4	54	47.0%
	3	28	24.3%
	2	12	10.4%
	1	5	4.3%
	0	16	13.9%
Secondary school completed in Germany (n = 482)	4	302	62.7%
	3	83	17.2%
	2	42	8.7%
	1	32	6.6%
	0	23	4.8%
Secondary school completed abroad (n = 56)	4	25	44.6%
	3	16	28.6%
	2	3	5.4%
	1	2	3.6%
	0	10	17.9%
Math not attended as advanced course in secondary school (n = 186)	4	64	34.4%
	3	54	29.0%
	2	26	14.0%
	1	22	11.8%
	0	20	10.8%
Math attended as advanced course in secondary school (n = 303)	4	242	79.9%
	3	38	12.5%
	2	14	4.6%
	1	5	1.7%
	0	4	1.3%
No math preparatory course attended (n = 238)	4	129	54.2%
	3	50	21.0%
	2	23	9.7%
	1	22	9.2%
	0	14	5.9%
Math preparatory course attended (n = 298)	4	196	65.8%
	3	49	16.4%
	2	22	7.4%
	1	12	4.0%
	0	19	6.4%
University of applied sciences (n = 138)	4	55	39.9%
	3	31	22.5%
	2	15	10.9%
	1	21	15.2%
	0	16	11.6%
University (n = 400)	4	272	68.0%
	3	68	17.0%
	2	30	7.5%
	1	13	3.3%
	0	17	4.3%

Frequencies			
Groups	Points	Frequencies	Percent (%)
Online Participation (n = 359)	4	206	57.4%
	3	67	18.7%
	2	32	8.9%
	1	31	8.6%
	0	23	6.4%
Pen-and-Paper Participation (n = 179)	4	121	67.6%
	3	32	17.9%
	2	13	7.3%
	1	3	1.7%
	0	10	5.6%
Attended Gymnasium (n = 408)	4	278	68.1%
	3	65	15.9%
	2	31	7.6%
	1	16	3.9%
	0	18	4.4%
Attended Other Secondary School (n = 118)	4	45	38.1%
	3	31	26.3%
	2	14	11.9%
	1	18	15.3%
	0	10	8.5%

Note. Due to missing values on demographics questions, frequencies within groups may not add up to the total number of responses.

Plots

All plots are generated from **Model A11**.

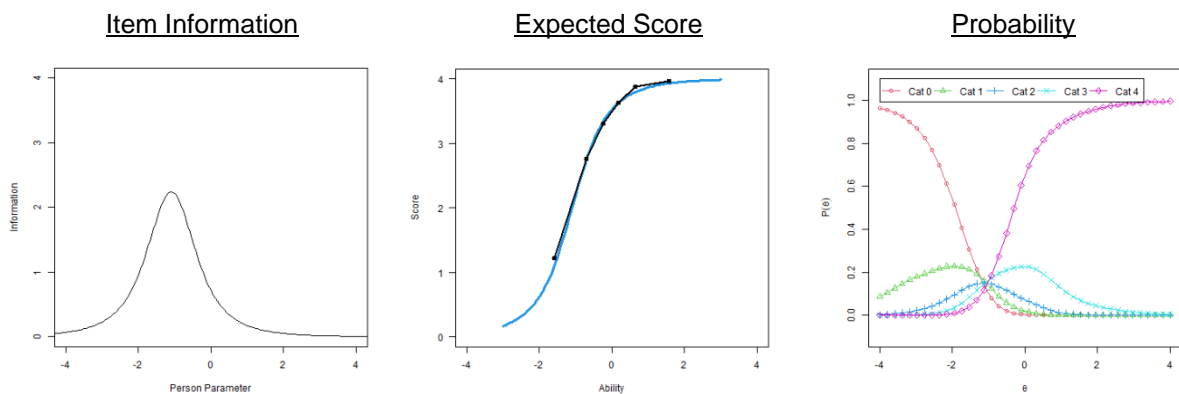

Note. The blue line represents expected performance, and the black line represents actual performance.

Note. Cat n = probability of receiving n points.

Differential Item Functioning (DIF)

This problem shows DIF based on attending math as an advanced or regular course in high school. The difficulty (β) parameter was significantly lower for those who attended math as an advanced course. Meanwhile, the discrimination (a) parameter was significantly higher for the same group. This shows that the problem was significantly easier but more informative for those who attended math as an advanced course in high school.

Expected Score (math attended as advanced course in high school)

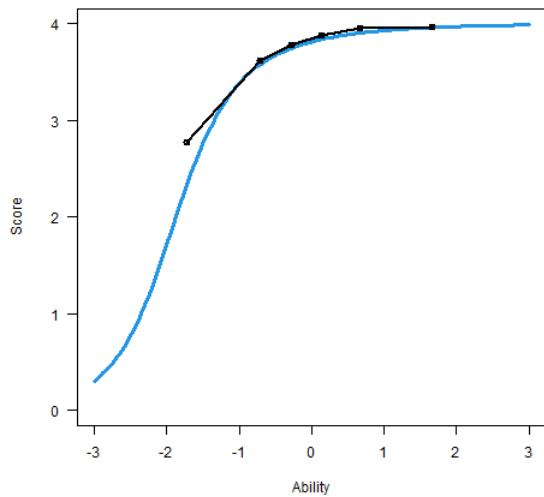

Expected Score (math not attended as advanced course in high school)

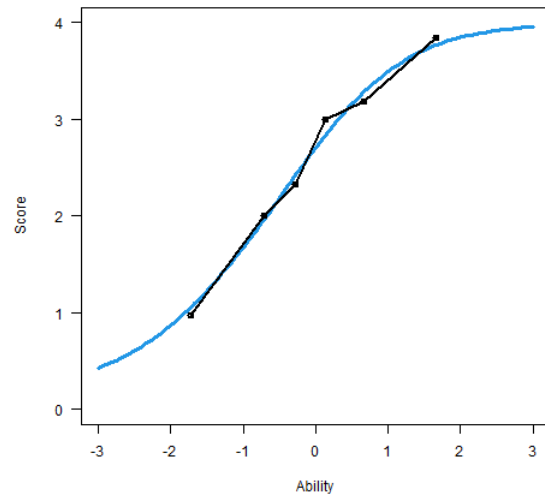

Note. The blue line represents expected performance, and the black line represents actual performance.

4.11.11. Positional Relationship of Lines and Planes (V11)

Lagebeziehung Gerade und Ebene

Wie können eine Gerade und eine Ebene im \mathbb{R}^3 zueinander liegen?

Wählen Sie eine oder mehrere richtige Antworten.

Sie haben genau einen Punkt gemeinsam.

Sie haben genau zwei Punkte gemeinsam.

Die Gerade liegt parallel zur Ebene.

Sie liegen weder parallel zueinander, noch haben sie gemeinsame Punkte.

Math Problem ID

V11

Correct Answers and Answer Frequencies

Answer	Correct Answer(s)	Number Correct Answers	Number Incorrect Answers
Sie haben genau einen Punkt gemeinsam.	blinded	blinded	blinded
Sie haben genau zwei Punkte gemeinsam.	blinded	blinded	blinded
Die Gerade liegt parallel zur Ebene.	blinded	blinded	blinded
Sie liegen weder parallel, noch haben sie gemeinsame Punkte.	blinded	blinded	blinded

Note. Scoring (PCS4): One point is earned for choosing the first answer option and simultaneously rejecting the second answer option. Another point is earned for choosing the third answer option and simultaneously rejecting the fourth answer option (up to 2 points possible).

Item Characteristics

Discrimination					
Measurement Type		Model A11	Model B	Model C	Model D
Correlation to participant ability (θ)		0.66	0.58	0.57	0.58
Discrimination Parameter (α)		1.59	1.25	0.81	1.50
Difficulty					
Measurement Type	Points	Model A11	Model B	Model C	Model D
Difficulty for participant of average ability level	2	-0.34	-0.34	-0.61	-0.31
	1	-1.05	-1.12	-1.75	-1.04
	0	NA	NA	NA	NA
Cumulative probability for participant of average ability level	2	66.3%	63.7%	65.9%	64.5%
	1	92.8%	89.7%	90.1%	91.5%
	0	100%	100%	100%	100%
Frequencies					
Groups	Points	Frequencies		Percent (%)	
Complete sample for this math problem (n = 538)	2	329		61.2%	
	1	115		21.4%	
	0	94		17.5%	
Female (n = 167)	2	73		43.7%	
	1	54		32.3%	
	0	40		24.0%	
Male (n = 366)	2	253		69.1%	
	1	61		16.7%	
	0	52		14.2%	
German as primary language at home (n = 422)	2	285		67.5%	
	1	81		19.2%	
	0	56		13.3%	
Other language as primary language at home (n = 115)	2	43		37.4%	
	1	34		29.6%	
	0	38		33.0%	
Secondary school completed in Germany (n = 482)	2	316		65.6%	
	1	94		19.5%	
	0	72		14.9%	
Secondary school completed abroad (n = 56)	2	13		23.2%	
	1	21		37.5%	
	0	22		39.3%	
Math not attended as advanced course in secondary school (n = 186)	2	73		39.2%	
	1	55		29.6%	
	0	58		31.2%	
Math attended as advanced course in secondary school (n = 303)	2	237		78.2%	
	1	51		16.8%	
	0	15		5.0%	

Frequencies			
Groups	Points	Frequencies	Percent (%)
No math preparatory course attended (n = 238)	2	128	53.8%
	1	53	22.3%
	0	57	23.9%
Math preparatory course attended (n = 298)	2	199	66.8%
	1	62	20.8%
	0	37	12.4%
University of applied sciences (n = 138)	2	60	43.5%
	1	28	20.3%
	0	50	36.2%
University (n = 400)	2	269	67.3%
	1	87	21.8%
	0	44	11.0%
Online Participation (n = 359)	2	209	58.2%
	1	78	21.7%
	0	72	20.1%
Pen-and-Paper Participation (n = 179)	2	120	67.0%
	1	37	20.7%
	0	22	12.3%
Attended Gymnasium (n = 408)	2	279	68.4%
	1	78	19.1%
	0	51	12.5%
Attended Other Secondary School (n = 118)	2	46	39.0%
	1	33	28.0%
	0	39	33.1%

Note. Due to missing values on demographics questions, frequencies within groups may not add up to the total number of responses.

Plots

All plots are generated from **Model A11**.

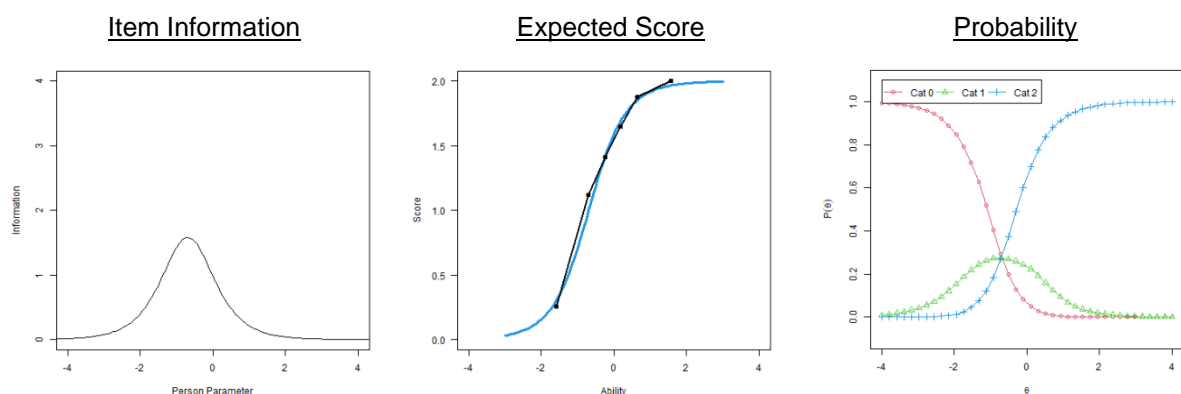

Note. The blue line represents expected performance, and the black line represents actual performance.

Note. Cat n = probability of receiving n points.

Differential Item Functioning (DIF)

This problem shows DIF across primary language. The difficulty (β) parameter was significantly higher for those who spoke a different language than German as their primary language at home. Meanwhile, the discrimination (α) parameter was significantly lower for those who spoke a different language than German at home. This shows that the problem was significantly easier and more informative for those who spoke German at home.

Expected Score (German as primary language)

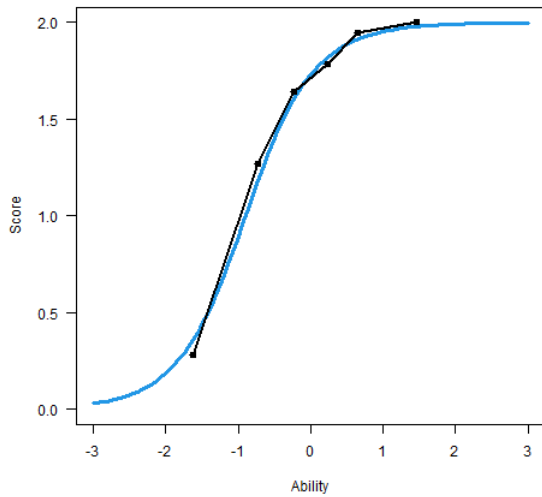

Expected Score (other primary language)

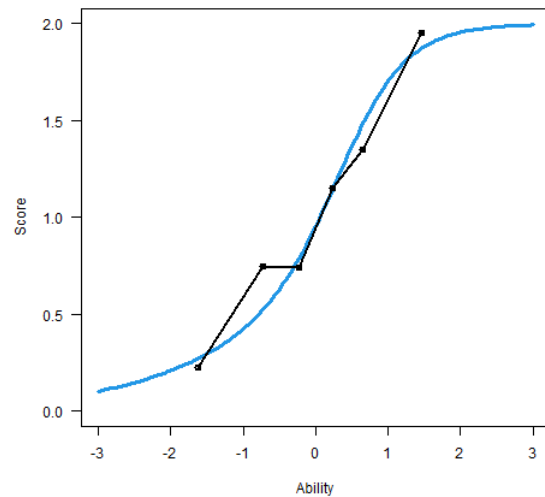

Note. The blue line represents expected performance, and the black line represents actual performance.

4.11.12. Orthogonality (V12)

Orthogonalität

Gegeben sind zwei Vektoren $\vec{u}, \vec{v} \in \mathbb{R}^2$, die jeweils ungleich dem Nullvektor sind. \vec{u} und \vec{v} liegen orthogonal zueinander. Welche der folgenden Gleichungen gilt dann?

Wählen Sie die richtige Antwort.

A $\vec{u} + \vec{v} = 0$

B $\vec{u} - \vec{v} = 0$

C $\vec{u} \cdot \vec{v} = 0$

D $\frac{\vec{u}}{\vec{v}} = 0$

Math Problem ID

V12

Correct Answers and Answer Frequencies

Correct Answer	Number Correct Answers	Number Incorrect Answers	Answer Frequencies			
			A	B	C	D
blinded	blinded	blinded	blinded	blinded	blinded	blinded

Note. Scoring (PCS4): Every correct response is worth one point (up to 1 point possible).

^a Includes cases, where the problem was seen but not answered.

Item Characteristics

Discrimination					
Measurement Type		Model A11	Model B	Model C	Model D
Correlation to participant ability (θ)		0.58	0.54	0.52	0.53
Discrimination Parameter (α)		1.91	1.81	1.10	1.97
Difficulty					
Measurement Type	Points	Model A11	Model B	Model C	Model D
Difficulty for participant of average ability level	1	-0.89	-0.85	-1.37	-0.83
	0	NA	NA	NA	NA
Cumulative probability for participant of average ability level	1	84.6%	82.3%	81.8%	83.8%
	0	100%	100%	100%	100%
Frequencies					
Groups	Points	Frequencies		Percent (%)	
Complete sample for this math problem (n = 535)	1	402		75.1%	
	0	133		24.9%	
Female (n = 162)	1	116		71.6%	
	0	46		28.4%	
Male (n = 367)	1	283		77.1%	
	0	84		22.9%	

Frequencies			
Groups	Points	Frequencies	Percent (%)
German as primary language at home (n = 426)	1	322	75.6%
	0	104	24.4%
Other language as primary language at home (n = 107)	1	79	73.8%
	0	28	26.2%
Secondary school completed in Germany (n = 480)	1	360	75.0%
	0	120	25.0%
Secondary school completed abroad (n = 53)	1	41	77.4%
	0	12	22.6%
Math not attended as advanced course in secondary school (n = 186)	1	113	60.8%
	0	73	39.2%
Math attended as advanced course in secondary school (n = 296)	1	251	84.8%
	0	45	15.2%
No math preparatory course attended (n = 248)	1	172	69.4%
	0	76	30.6%
Math preparatory course attended (n = 284)	1	229	80.6%
	0	55	19.4%
University of applied sciences (n = 138)	1	69	50.0%
	0	69	50.0%
University (n = 397)	1	333	83.9%
	0	64	16.1%
Online Participation (n = 360)	1	274	76.1%
	0	86	23.9%
Pen-and-Paper Participation (n = 175)	1	128	73.1%
	0	47	26.9%
Attended Gymnasium (n = 408)	1	330	80.9%
	0	78	19.1%
Attended Other Secondary School (n = 115)	1	66	57.4%
	0	49	42.6%

Note. Due to missing values on demographics questions, frequencies within groups may not add up to the total number of responses.

Plots

All plots are generated from **Model A11**.

Item Information

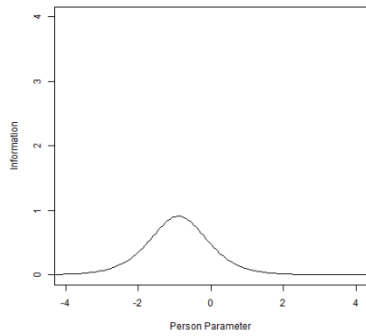

Expected Score

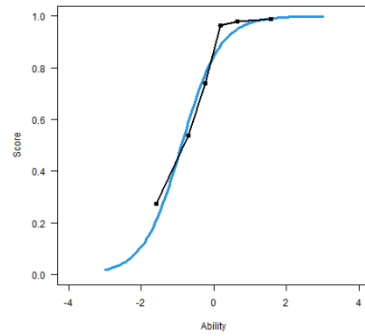

Probability

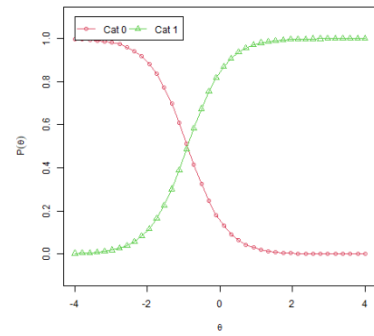

Note. The blue line represents expected performance, and the black line represents actual performance.

Note. Cat n = probability of receiving n points.

4.11.13. Linear Dependence (V13)

Linear abhängig

Gegeben sei der Vektor \vec{u} :

$$\vec{u} = \begin{pmatrix} 2 \\ 4 \end{pmatrix}$$

Welche der folgenden Vektoren sind linear abhängig von \vec{u} ?

Wählen Sie eine oder mehrere richtige Antworten.

$\begin{pmatrix} 8 \\ 16 \end{pmatrix}$

$\begin{pmatrix} 3 \\ 5 \end{pmatrix}$

$\begin{pmatrix} -1 \\ -2 \end{pmatrix}$

$\begin{pmatrix} -6 \\ 12 \end{pmatrix}$

Math Problem ID

V13

Correct Answers and Answer Frequencies

Answer	Correct Answer(s)	Number Correct Answers	Number Incorrect Answers
$\begin{pmatrix} 8 \\ 16 \end{pmatrix}$	blinded	blinded	blinded
$\begin{pmatrix} 3 \\ 5 \end{pmatrix}$	blinded	blinded	blinded
$\begin{pmatrix} -1 \\ -2 \end{pmatrix}$	blinded	blinded	blinded
$\begin{pmatrix} -6 \\ 12 \end{pmatrix}$	blinded	blinded	blinded

Note. Scoring (PCS4): Every correct response and correct rejection is worth one point (up to 4 points possible).

Item Characteristics

Discrimination					
Measurement Type		Model A11	Model B	Model C	Model D
Correlation to participant ability (θ)		0.46	0.40	0.41	0.40
Discrimination Parameter (α)		0.45	0.44	0.43	0.46
Difficulty					
Measurement Type	Points	Model A11	Model B	Model C	Model D
Difficulty for participant of average ability level	4	-0.64	-0.59	-0.80	-0.59
	3	-1.87	-1.81	-2.68	-1.79
	2	-2.10	-2.04	-3.61	-2.01
	1	-2.62	-2.56	-5.41	-2.52
	0	NA	NA	NA	NA
Cumulative probability for participant of average ability level	4	61.2%	60.3%	61.5%	60.6%
	3	91.0%	90.3%	91.4%	90.6%
	2	94.6%	94.0%	97.8%	94.3%
	1	97.4%	97.0%	99.7%	97.2%
	0	100%	100%	100%	100%
Frequencies					
Groups	Points	Frequencies	Percent (%)		
Complete sample for this math problem (n = 534)	4	315	59.0%		
	3	147	27.5%		
	2	20	3.7%		
	1	21	3.9%		
	0	31	5.8%		
Female (n = 162)	4	85	52.5%		
	3	52	32.1%		
	2	7	4.3%		
	1	6	3.7%		
	0	12	7.4%		
Male (n = 366)	4	228	62.3%		
	3	94	25.7%		
	2	13	3.6%		
	1	15	4.1%		
	0	16	4.4%		
German as primary language at home (n = 425)	4	258	60.7%		
	3	121	28.5%		
	2	14	3.3%		
	1	14	3.3%		
	0	18	4.2%		

Frequencies			
Groups	Points	Frequencies	Percent (%)
Other language as primary language at home (n = 107)	4	57	53.3%
	3	26	24.3%
	2	6	5.6%
	1	6	5.6%
	0	12	11.2%
Secondary school completed in Germany (n = 479)	4	290	60.5%
	3	131	27.3%
	2	18	3.8%
	1	16	3.3%
	0	24	5.0%
Secondary school completed abroad (n = 53)	4	25	47.2%
	3	15	28.3%
	2	2	3.8%
	1	5	9.4%
	0	6	11.3%
Math not attended as advanced course in secondary school (n = 186)	4	78	41.9%
	3	71	38.2%
	2	11	5.9%
	1	13	7.0%
	0	13	7.0%
Math attended as advanced course in secondary school (n = 295)	4	212	71.9%
	3	61	20.7%
	2	4	1.4%
	1	4	1.4%
	0	14	4.7%
No math preparatory course attended (n = 247)	4	141	57.1%
	3	67	27.1%
	2	11	4.5%
	1	9	3.6%
	0	19	7.7%
Math preparatory course attended (n = 284)	4	172	60.6%
	3	80	28.2%
	2	9	3.2%
	1	12	4.2%
	0	11	3.9%
University of applied sciences (n = 138)	4	59	42.8%
	3	52	37.7%
	2	10	7.2%
	1	8	5.8%
	0	9	6.5%
University (n = 396)	4	256	64.6%
	3	95	24.0%
	2	10	2.5%
	1	13	3.3%
	0	22	5.6%

Frequencies			
Groups	Points	Frequencies	Percent (%)
Online Participation (n = 359)	4	193	53.8%
	3	114	31.8%
	2	16	4.5%
	1	17	4.7%
	0	19	5.3%
Pen-and-Paper Participation (n = 175)	4	122	69.7%
	3	33	18.9%
	2	4	2.3%
	1	4	2.3%
	0	12	6.9%
Attended Gymnasium (n = 407)	4	261	64.1%
	3	103	25.3%
	2	12	2.9%
	1	10	2.5%
	0	21	5.2%
Attended Other Secondary School (n = 115)	4	50	43.5%
	3	40	34.8%
	2	7	6.1%
	1	11	9.6%
	0	7	6.1%

Note. Due to missing values on demographics questions, frequencies within groups may not add up to the total number of responses.

Plots

All plots are generated from **Model A11**.

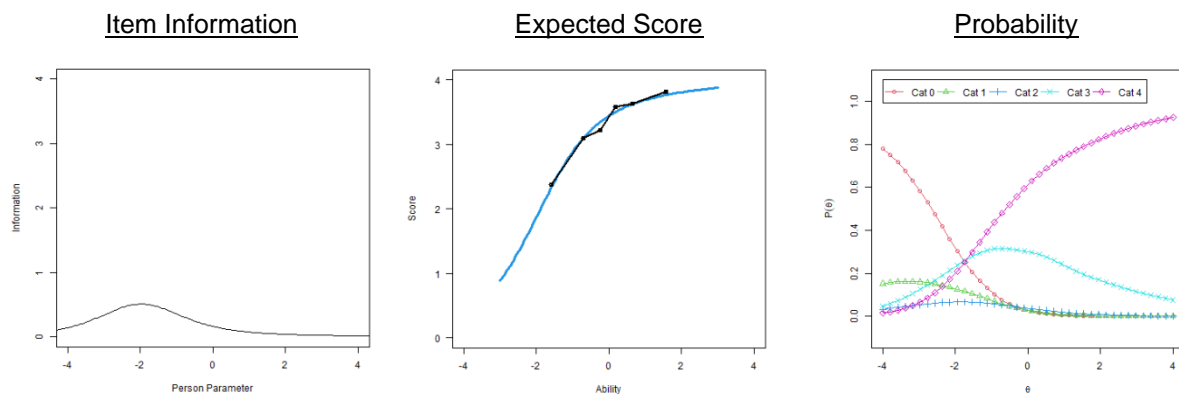

Note. The blue line represents expected performance, and the black line represents actual performance.

Note. Cat n = probability of receiving n points.

5. Qualitative Analyses of Math Problems That Were Changed After the Main Study for the Final Implementation in orca.nrw

After the main study, additional changes were implemented in 7 out of the final 117 problems. The content experts deemed these changes necessary due to imprecise wording, or typos that occurred during the programming of the items for the main study. In order to test whether the implemented changes were interpreted as intended and that the interpretation of the math problems would not change otherwise, we performed qualitative interviews using cognitive pretesting (Karabenick et al., 2007). In total, 20 interviews with students enrolled in engineering, math, or science study programs were conducted by a trained research assistant. In the interviews, students were first shown the revised version of each math problem, so that it was possible to determine whether the revised problem would be interpreted as intended without having any knowledge of the old version. The students were asked to solve the revised problem, while verbalizing their thoughts (i.e., the think-aloud method was used). Next, the students were shown the old version of the problem and were asked whether they could identify any changes compared to the version they had first worked on. If the students did not notice any changes between the two versions, they were made aware of the changes. Finally, the students were asked whether their interpretation of the problem had changed, whether they would give different answers on both versions, and which version they preferred for the final implementation of the test and why.

5.1. (Lowest) Common Denominator in Fractions (GR9)

Implemented Changes

The problem was changed because it is not mathematically necessary to determine the smallest common denominator for subtracting fractions (i.e., any common denominator is sufficient). The title and text of the problem were changed accordingly.

Old Version:
Title: „Kleinster gemeinsamer Nenner in Brüchen“

Gemeinsamer Nenner bei Brüchen

Bei welchen der folgenden Fragestellungen innerhalb der Bruchrechnung ist das Bestimmen eines gemeinsamen Nenners notwendig?

Wählen Sie eine oder mehrere richtige Antworten.

Old Version:
„von kleinsten gemeinsamen Nennern“ instead of „eines gemeinsamen Nenners“

Multiplikation von Brüchen

Kehrwertbestimmung

Division von Brüchen

Subtraktion von Brüchen

Key Results From the Interviews

Most students noticed the difference between the two versions (i.e., smallest vs. any common denominator) and were aware that any common denominator would be sufficient in order to subtract fractions. Some students argued that in the old version, no answer would be correct and that the old problem was contradictory due to the instruction that at least one correct solution should be chosen. These students said that they likely would not give any answer in the old problem, but would choose the correct answer in the revised version.

5.2. Sets (Numerical Ranges) (GR12)

Implemented Changes

The term “Menge” was replaced by “Zahlbereich” because the latter is the more common term used in secondary school (see NRW curriculum). The instruction was separated from the first sentence to be consistent with other problems in the test.

Zahlbereiche

Old Version:
Title: „Mengen“

Entscheiden Sie in jeder Zelle der Tabelle, ob die jeweilige Zahl zum angegebenen Zahlbereich gehört.

Kreuzen Sie pro Zeile ein oder mehrere Felder an.

Old Version:
„Entscheiden Sie in jeder Zelle der Tabelle, ob das jeweilige Element in der jeweiligen Menge enthalten ist. Kreuzen Sie an, falls es enthalten ist.“

	\mathbb{Z}	\mathbb{Q}	\mathbb{R}
-2	<input type="checkbox"/>	<input type="checkbox"/>	<input type="checkbox"/>
$\frac{1}{2}$	<input type="checkbox"/>	<input type="checkbox"/>	<input type="checkbox"/>
$\sqrt{2}$	<input type="checkbox"/>	<input type="checkbox"/>	<input type="checkbox"/>
$0,\bar{3}$	<input type="checkbox"/>	<input type="checkbox"/>	<input type="checkbox"/>

Key Results From the Interviews

Students who commented on the different terms (“Menge” vs. “Zahlbereich”) mostly said that “Menge” would be more common in the postsecondary education context, whereas “Zahlbereich” was more commonly used in school. Both versions of the problem were interpreted identically by all students. Most students preferred the revised version of the problem because the instruction was visually separated from the problem.

5.3. Lines (EF4)

Implemented Changes

The first two parts of the problem were slightly changed (i.e., plural instead of singular) for stylistic reasons. The last part of the problem was changed because the old version was mathematically imprecise (i.e., $g(x)$ does not intersect the y -axis but rather the graph of g).

Geraden

Gegeben sei die Gerade g mit $g(x) = 2 \cdot x - 4$.

Ergänzen Sie die freien Felder.

- Geben Sie die Steigung m_p aller Geraden an, die zu g parallel liegen:

$m_p =$

Old Version:
 Geben Sie die Steigung m_p jeder Geraden an, die zu g parallel liegt:
- Geben Sie die Steigung m_s aller Geraden an, die auf g senkrecht stehen:

$m_s =$

Old Version:
 Geben Sie die Steigung m_s jeder Geraden an, die auf g senkrecht steht:
- Geben Sie den y -Achsenabschnitt von g an:

$y =$

Old Version:
 Geben Sie an, wo $g(x)$ die y -Achse schneidet:

Key Results From the Interviews

The majority of all students only noticed the change in the last part of the problem but not the changes to the first two parts. All but one student said that their interpretation of the problem would not change between the two versions and that they would give the same answer to both versions. Some students preferred the old version because the phrasing was more descriptive and the term “ y -Achsenabschnitt” was unclear to them, whereas others preferred the revised version because it includes the technical term “ y -Achsenabschnitt.” Thus, we suggested a combination of both versions (“Geben Sie den y -Achsenabschnitt von g an, d.h. wo g die y -Achse schneidet”). An exchange with the content experts resulted in the following phrasing, which is closer to the old version but mathematically precise: “Geben Sie an, wo der Graph von g die y -Achse schneidet.”

5.4. Symmetry (G9)

Implemented Changes

This problem was not programmed correctly in the main study (i.e., the second part was missing). For the final implementation, part b) will be included again.



Symmetrie

Old Version only contained part a) but not part b) of the problem.

a)

Welche der folgenden Zeichen sind achsensymmetrisch?



Wählen Sie eine oder mehrere richtige Antworten.

			
---	---	---	---

b)

Welche der folgenden Zeichen sind punktsymmetrisch?

Wählen Sie eine oder mehrere richtige Antworten.

			
---	---	---	---

Key Results From the Interviews

Most students who mentioned a priority for one of the versions liked the revised version including both parts better because axis and point symmetry are concepts that are typically covered together.

5.5. Difference Quotient (D9)

Implemented Changes

The following text was added to the math problem “zur Funktion f im Intervall $[x_0, x_0 + h]$ ” to be mathematically precise (i.e., clarify the function and interval of the difference quotient).

Differenzenquotient

Welcher der folgenden Terme ist der Differenzenquotient zur Funktion f im Intervall $[x_0, x_0 + h]$?

Wählen Sie die richtige Antwort.

Old version:
„Welcher der folgenden Terme ist der Differenzenquotient?“

$$\frac{f(x_0 + h) - f(x_0)}{x_0 + h}$$

$$\frac{f(x_0 + h) + f(x_0)}{h}$$

$$\frac{f(x_0 + h) - f(x_0)}{h}$$

$$\frac{f(x_0 - h) - f(x_0 + h)}{h}$$

Key Results From the Interviews

Most students recognized the difference between the old and revised version of the problem. All students said that their interpretation of the math problem would not change between the two versions. The majority of all students preferred the revised version because it is mathematically more precise.

5.6. Integration of a Monomial (I9)

Implemented Changes

A specification for the allowed values for n was added because the answer would not be correct otherwise (i.e., for $n = -1$). In the third answer option, x was replaced with n in the exponent. This was a typo that occurred in the programming of the study.

Integration eines Monoms

Welcher der folgenden Terme vervollständigt die rechte Seite für $n \neq -1$ korrekt?

$$\int x^n dx = \dots$$

Old version:
„Welcher der folgenden
Terme vervollständigt die
rechte Seite korrekt?“

Wählen Sie die richtige Antwort.

$\frac{1}{n}x^{n+1} + c$

$\frac{1}{n+1}x^{n+1} + c$

$nx^{n+1} + c$

$(n+1)x^{n+1} + c$

Old version: $nx^{x+1} + c$

Key Results From the Interviews

Around half of all students noticed that $n \neq -1$ was only part of the revised version. When asked about this addition, all students said that this was a necessary change because the correct answer (answer #2) would not be correct (or not defined) in case $n = -1$. Some students felt that the first sentence in the revised version was more complicated due to the addition of the restriction on n and suggested that this restriction could be placed somewhere else (e.g., on the right-hand side after the integral). We suggested this additional change for the final implementation of the test in orca.nrw. Only one student noticed the change in the distractor, but said that this would not change his answer.

5.7. Position Problems (V9)

Implemented Changes

The vectors in the old problem were incorrectly specified as two-dimensional instead of three-dimensional, which is necessary for part b) of the problem (skewed vectors are not possible in \mathbb{R}^2). The sentence (“Entscheiden Sie...”) was moved to part a) of the problem, because it only refers to part a) (part b) is phrased as a question).

Lageprobleme

Gegeben sind zwei Geraden g_1 und g_2 im Raum mit

$g_1 : \vec{x} = \vec{a} + \lambda \cdot \vec{u} \quad \text{mit } \vec{a}, \vec{u} \in \mathbb{R}^3, \lambda \in \mathbb{R}.$

$g_2 : \vec{x} = \vec{b} + \mu \cdot \vec{v} \quad \text{mit } \vec{b}, \vec{v} \in \mathbb{R}^3, \mu \in \mathbb{R}.$

Wählen Sie jeweils eine oder mehrere richtige Antworten.

a)
Entscheiden Sie, welche der Aussagen in jedem Fall wahr ist.

g_1 und g_2 sind parallel oder identisch, wenn...

... \vec{u} und \vec{v} kollinear sind.

... \vec{a} und \vec{b} kollinear sind.

...die Gleichung $\vec{a} = \vec{b} + \mu \cdot \vec{v}$ eine Lösung hat.

b)
Wie können g_1 und g_2 zueinander liegen, wenn das durch Gleichsetzen entstehende Gleichungssystem keine Lösung besitzt?

Die Geraden sind windschief.

Die Geraden sind identisch.

Die Geraden schneiden sich in genau einem Punkt.

Die Geraden sind parallel zueinander, aber nicht identisch.

Old version:
„Gegeben sind zwei Geraden g_1 und g_2 mit“

Old version:
 \mathbb{R}^2 instead of \mathbb{R}^3

Old version:
The sentence „Entscheiden Sie...“ was shown before the sentence “Wählen Sie...”.

Key Results From the Interviews

Most students did not notice the change from \mathbb{R}^2 to \mathbb{R}^3 . When asked about it, the majority of all students argued that \mathbb{R}^3 is the correct specification because in Part b) skewed lines would not be possible in \mathbb{R}^2 and it would be a “trick question” in that case (because most students tended to overlook the dimensions of the vectors and would therefore incorrectly choose the first answer option in Part b) as correct in the two-dimensional case). Students had mixed opinions about moving the instruction (“Entscheiden Sie...”) to Part a) of the problem, but all students said that it likely would not change their interpretation and answers.

6. Validation Analyses

To further validate the test results, participant abilities based on WLE estimates (see Khorramdel et al., 2020) were correlated with demographic and motivational data. For details on WLE estimates of ability, see **Section 2.1**.¹ Correlations between ability estimates and validation criteria were estimated for all models (i.e., **Models A1-A11, B, C, and D**). Results were consistent for all models so only correlations for **Model D** are shown in the following sections.

First, data on students' exam performance in the course in which the data collection took place was obtained from the course instructors, conditional on students' consent. Most courses were introductory math courses or other quantitative courses (e.g., data science, quantitative methods) in the first year of students' study program. Performance data were collected in 22 out of 36 courses; 4 courses were not graded (e.g., preparatory math courses). This resulted in a sample of 2,069 students attending graded courses. Of those students, 1,124 gave consent to obtain their exam performance from their instructors (response rate: 54%). Because not all students took the exam, performance data were available for 851 students. We report correlations between students' ability estimates and their exam performance (i.e., percentage of points earned on a 0-to-100 scale) and whether students passed or failed their exam (i.e., pass-fail). One course reported only pass-fail grades, so that the percent score is available for 754 students. We report the correlations separately for all courses due to potential differences in content and structure of the exam (e.g., online exams due to the COVID pandemic, potential to earn bonus points, open-book exams), and also report a median correlation between test performance and course performance across all courses (**Table 14**). If performance data were available for less than 5 students within a course, we did not include the course in the following analyses (sufficient data were available for 19 courses). In summary, performance data were available for 851 students across 19 courses.

We report correlations between students' ability estimates and the following student characteristics, achievement indicators, and math-related motivations (**Table 15**):

- **Gender:** male vs. female/nonbinary
- **Primary language:** German vs. other
- **Type of secondary school:** Gymnasium vs. other
- **Advanced math course in high school:** taken vs. not taken/not offered
- **High school grade point average (“HZB-Note”):** Students reported the grade of their higher education entrance qualification in an open-response format. Answers were recoded to the standard German grade scale, ranging from 1 (highest grade; “*very good*”) to 4 (lowest passing grade; “*sufficient*”).
- **Final math grade in high school:** Students reported their final math grade in high school in points, i.e., on a 16-point scale ranging from 0 points to 15 points.
- **Type of postsecondary institution:** University vs. University of Applied Sciences
- **Participation in math preparatory courses:** Participated vs. not participated
- **Math self-concept:** Students' math self-concept was captured with three items adapted from Gaspard et al. (2015) on a 6-point scale from 1 (*strongly disagree*) to 6 (*strongly agree*). A sample item is “I am good at math.”
- **Math interest:** Students' math interest was captured with three items adapted from Gaspard et al. (2015) on a 6-point scale from 1 (*strongly disagree*) to 6 (*strongly agree*). A sample item is “I enjoy doing math.”

¹ We also estimated correlations between students' ability and the validation criteria using plausible value estimates of students' math ability. Plausible value estimation involved calculating 10 plausible values for the relevant scale or dimension based on random draws within the TAM module for R (R Core Team, 2021; Robitzsch et al., 2022). The results were consistent for all models so that we do not report correlations between plausible values of students' math ability and the different validation criteria.

Correlations between students’ test performance and their course performance in introductory math or other quantitative courses in postsecondary education underscores the predictive validity of the WINT-Check (**Table 14**). Across 18 math courses ($n_{\text{students}} = 754$), the median correlation between students’ test performance and course performance was $r = .458$ (range: .027 to .767).

In addition, bivariate correlations in **Table 14** show small associations between students’ test performance and their personal characteristics (i.e., gender, primary language), suggesting that male students and students whose primary language is German performed better on the test. In addition, we observed small to moderate associations between students’ test performance and their math interest, type of secondary school, and participation in math preparatory courses. Finally, students’ test performance showed moderate associations with their math self-concept, participation in advanced math courses in high school, and students’ overall high school grades as well as their math grades. Thus, students who had more learning opportunities with math in high school and who had better grades (in math) in high school also performed significantly better on the test.

Table 14. Associations of Ability Estimates (θ) from Model D and Course Performance

Correlations of ability estimates with course performance indicators					
	n_{students}	r with percent score	p	r with pass-fail indicator	p
Median		.458		.405	
Course #35	48	.767	< .001	.606	< .001
Course #34	17	.745	< .001	.791	< .001
Course #29	18	.740	< .001	.763	< .001
Course #10	15	.625	.013	.647	.009
Course #28	81	.568	< .001	.271	.015
Course #33	41	.545	< .001	.390	.012
Course #27	61	.502	< .001	.427	< .001
Course #15	75	.473	< .001	.419	< .001
Course #20	9	.466	.206	NA	NA
Course #23	22	.449	.036	.449	.036
Course #5	17	.440	.077	.540	.025
Course #30	172	.388	< .001	.380	< .001
Course #36	20	.376	.102	NA	NA
Course #26	51	.365	.009	.278	.048
Course #14	59	.203	.122	-.035	.785
Course #19	9	.176	.651	-.216	.576
Course #24	17	.071	.786	.336	.187
Course #21	13	.027	.929	-.016	.959
Course #25	97	a		.186	.068
Course #11	2	b		b	
Course #12	2	b		b	
Course #32	4	b		b	

^a Only pass-fail grades were available.

^b Insufficient number of cases available.

Table 15. Associations of Ability Estimates (θ) from Model D and Student Characteristics, Prior Achievement, and Motivation

	Model D											
	Overall Model	Subscale GR	Subscale P	Subscale TG	Subscale EF	Subscale G	Subscale TR	Subscale HF	Subscale D	Subscale I	Subscale L	Subscale V
Gender: male vs. female/nonbinary	.145***	.209***	.161***	.094*	.086*	.165***	.137***	.158***	.059	.114**	.011	.141***
Primary language: German vs. other	.024	.076*	-.103**	-.042	.063	.001	-.180***	-.021	.103**	.098**	.067	.139***
Type of secondary school: Gymnasium vs. other	.215***	.187***	.238***	.205***	.196***	.140***	.077*	.238***	.168***	.244***	.195***	.297***
Advanced math course: taken vs. not taken/not offered	.453***	.325***	.424***	.373***	.440***	.343***	.318***	.491***	.391***	.458***	.400***	.490***
High school grade point average (“HZB-Note”), 1=highest grade, 4=lowest passing grade	-.510***	-.377***	-.423***	-.450***	-.497***	-.403***	-.420***	-.473***	-.498***	-.555***	-.471***	-.462***
Final math grade in high school	.542***	.412***	.507***	.496***	.499***	.428***	.416***	.497***	.501***	.589***	.479***	.467***
Postsecondary institution: University vs. university of applied sciences	.337***	.240***	.324***	.278***	.308***	.301***	.265***	.353***	.327***	.347***	.294***	.364***
Math preparatory course: Participated vs. not participated	.206***	.186***	.197***	.152***	.173***	.162***	.136***	.225***	.237***	.226***	.165***	.177***
Math self-concept	.516***	.433***	.466***	.441***	.483***	.428***	.395***	.457***	.474***	.522***	.453***	.478***
Math interest	.437***	.338***	.417***	.372***	.435***	.336***	.345***	.411***	.396***	.430***	.378***	.390***

* $p < .05$, ** $p < .01$, *** $p < .001$.

7. References

- Adams, R. J., & Gonzalez, E. J. (1996). The TIMSS test design. In M. O. Martin & D. L. Kelly (Eds.), *Third International Mathematics and Science Study. Technical Report. Volume I: Design and Development* (3-1 to 3-36). Distributed by ERIC Clearinghouse.
- Ayala, R. J. de. (2009). *The theory and practice of item response theory. Methodology in the social sciences*. Guilford Press.
- Bazaldúa, D. A. L., Lee, Y.-S., Keller, B., & Fellers, L. (2017). Assessing the performance of classical test theory item discrimination estimators in Monte Carlo simulations. *Asia Pacific Education Review, 18*(4), 585–598. <https://doi.org/10.1007/s12564-017-9507-4>
- Benden, D. K., & Lauermann, F. (2022). Students' motivational trajectories and academic success in math-intensive study programs: Why short-term motivational assessments matter. *Journal of Educational Psychology, 114*(5), 1062–1085. <https://doi.org/10.1037/edu0000708>
- Bichi, A. A., & Talib, R. (2018). Item response theory: An introduction to latent trait models to test and item development. *International Journal of Evaluation and Research in Education (IJERE), 7*(2), 142. <https://doi.org/10.11591/ijere.v7i2.12900>
- Christensen, K. B., Makransky, G., & Horton, M. (2017). Critical Values for Yen's Q3: Identification of local dependence in the Rasch model using residual correlations. *Applied Psychological Measurement, 41*(3), 178–194. <https://doi.org/10.1177/0146621616677520>
- Cook, K. F., Dodd, B. G., & Fitzpatrick, S. J. (1999). A comparison of three polytomous item response theory models in the context of testlet scoring. *Journal of Outcome Measurement, 3*(1), 1–20.
- Gaspard, H., Dicke, A.-L., Flunger, B., Schreier, B., Häfner, I., Trautwein, U., & Nagengast, B. (2015). More value through greater differentiation: Gender differences in value beliefs about math. *Journal of Educational Psychology, 107*(3), 663–677. <https://doi.org/10.1037/edu0000003>
- Green, B. F., Bock, R. D., Humphreys, L. G., Linn, R. L., & Reckase, M. D. (1984). Technical guidelines for assessing computerized adaptive tests. *Journal of Educational Measurement, 21*(4), 347–360. <https://doi.org/10.1111/j.1745-3984.1984.tb01039.x>
- Khorramdel, L., Davier, M. von, Gonzalez, E., & Yamamoto, K. (2020). Plausible values: Principles of item response theory and multiple imputations. In D. B. Maehler & B. Rammstedt (Eds.), *Methodology of Educational Measurement and Assessment. Large-Scale Cognitive Assessment* (pp. 27–47). Springer International Publishing. https://doi.org/10.1007/978-3-030-47515-4_3
- Muraki, E. (1992). A generalized partial credit model: Application of an EM algorithm. *ETS Research Report Series, 1992*(1), i-30. <https://doi.org/10.1002/j.2333-8504.1992.tb01436.x>
- Muraki, E. (1997). A generalized partial credit model. In W. J. van der Linden & R. K. Hambleton (Eds.), *Handbook of modern item response theory* (pp. 153–164). Springer New York. https://doi.org/10.1007/978-1-4757-2691-6_9
- Penfield, R. D., & Bergeron, J. M. (2005). Applying a weighted maximum likelihood latent trait estimator to the generalized partial credit model. *Applied Psychological Measurement, 29*(3), 218–233. <https://doi.org/10.1177/0146621604270412>
- R Core Team. (2021). *R: A language and environment for statistical computing*. Vienna, Austria. R Foundation for Statistical Computing. <https://www.R-project.org/>
- Robitzsch, A., Kiefer, T., & Wu, M. (2022). *Package 'TAM'*. <https://cran.r-project.org/web/packages/TAM/TAM.pdf>
- Robitzsch, A., & Steinfeld, J. (2018). Item response models for human ratings: Overview, estimation methods, and implementation in R. *Psychological Test and Assessment Modeling, 60*(1), 101–139.
- Schnick-Vollmer, K., Diefenbach, C., Gräf, C., Hoffmann, D., Hoffmann, I., Imhof, M., Kiefer, T., König, J., Schlecht, J., Schmidt, M. F., & Urschitz, M. S. (2020). Indikatoren schulischen Wohlbefindens bei gesunden und chronisch kranken Kindern: Psychometrische Prüfung und Validierung adaptierter FEES-Skalen. *Zeitschrift Für Pädagogische Psychologie, 34*(3-4), 201–219. <https://doi.org/10.1024/1010-0652/a000259>
- Shu, L., & Schwarz, R. D. (2014). IRT-estimated reliability for tests containing mixed item formats. *Journal of Educational Measurement, 51*(2), 163–177. <https://doi.org/10.1111/jedm.12040>
- Suh, Y., & Cho, S.-J. (2014). Chi-square difference tests for detecting differential functioning in a multidimensional IRT model. *Applied Psychological Measurement, 38*(5), 359–375. <https://doi.org/10.1177/0146621614523116>

- Taber, K. S. (2018). The use of cronbach's alpha when developing and reporting research instruments in science education. *Research in Science Education*, 48(6), 1273–1296. <https://doi.org/10.1007/s11165-016-9602-2>
- Warm, T. A. (1989). Weighted likelihood estimation of ability in item response theory. *Psychometrika*, 54(3), 427–450. <https://doi.org/10.1007/BF02294627>
- Westermann, R., Elke, H., Spies, K., & Trautwein, U. (1996). Identifikation und Erfassung von Komponenten der Studienzufriedenheit. *Psychologie in Erziehung Und Unterricht*, 43(1), 1–22. <https://www.fachportal-paedagogik.de/literatur/vollanzeige.html?FId=390780>
- WINT-Check Mathematik: Handreichung [WINT-Check mathematics: handbook]. (2017). https://beta.orca.nrw/media/download/pdfs/handreichungen/Handreichung_WINT-Check-Mathematik.pdf
- Yen, W. M. (1984). Effects of local item dependence on the fit and equating performance of the three-parameter logistic model. *Applied Psychological Measurement*, 8(2), 125–145. <https://doi.org/10.1177/014662168400800201>
- Yılmaz, H. B. (2019). A comparison of IRT model combinations for assessing fit in a mixed format elementary school science test. *International Electronic Journal of Elementary Education*, 11(5), 539–545. <https://doi.org/10.26822/iejee.2019553350>

8. Appendix

8.1. Changed Problems in Partial Credit Scoring Version 4 (PCS4)

8.1.1. Lowest Common Denominator in Fractions (GR9)

Kleinster gemeinsamer Nenner in Brüchen

Bei welchen der folgenden Fragestellungen innerhalb der Bruchrechnung ist das Bestimmen von kleinsten gemeinsamen Nennern notwendig?

Wählen Sie eine oder mehrere richtige Antworten.

- Multiplikation von Brüchen
- Kehrwertbestimmung
- Division von Brüchen
- Subtraktion von Brüchen
- Größenvergleich von Brüchen

Math Problem ID

GR9

Change

Answer option 5 “Größenvergleich von Brüchen” was removed.

Reason for Change Made by Content Experts

The fifth answer option was chosen by the majority of participants, which suggests that these participants noticed that determining a common denominator can be helpful when comparing two fractions, although it is not strictly necessary. Thus, content experts decided to remove this answer option.

Correct Answers (PCS3)

Answer	Correct Answer(s)	Number Correct Answers	Number Incorrect Answers
Multiplikation von Brüchen	blinded	blinded	blinded
Kehrwertbestimmung	blinded	blinded	blinded
Division von Brüchen	blinded	blinded	blinded
Subtraktion von Brüchen	blinded	blinded	blinded
Größenvergleich von Brüchen	blinded	blinded	blinded

Scoring (PCS3): Every correct response and correct rejection is worth one point (up to 5 points possible).

Item Characteristics (PCS3)

Discrimination					
Measurement Type		Model A1	Model B	Model C	Model D
Correlation to participant ability (θ)		0.37	0.37	0.41	0.37
Discrimination Parameter (α)		0.35	0.37	0.67	0.38
Difficulty					
Measurement Type	Points	Model A1	Model B	Model C	Model D
Difficulty for participant of average ability level	5	4.68	4.41	2.59	4.31
	4	-1.09	-1.12	-0.98	-1.07
	3	-2.32	-2.31	-2.11	-2.23
	2	-3.05	-3.02	-3.21	-2.93
	1	-3.58	-3.52	-4.59	-3.42
	0	NA	NA	NA	NA
Cumulative probability for participant of average ability level	5	11.8%	12.0%	11.5%	11.8%
	4	66.6%	67.7%	72.5%	67.4%
	3	88.5%	89.4%	93.7%	89.3%
	2	96.2%	96.7%	99.3%	96.6%
	1	97.9%	98.2%	100%	98.2%
	0	100%	100%	100%	100%
Frequencies					
Groups	Points	Frequencies		Percent (%)	
Complete sample for this math problem (n = 565)	5	70		12.4%	
	4	296		52.4%	
	3	119		21.1%	
	2	46		8.1%	
	1	13		2.3%	
	0	21		3.7%	
Female (n = 202)	5	22		10.9%	
	4	105		52.0%	
	3	40		19.8%	
	2	16		7.9%	
	1	11		5.4%	
	0	8		4.0%	
Male (n = 348)	5	46		13.2%	
	4	186		53.4%	
	3	73		21.0%	
	2	28		8.0%	
	1	2		0.6%	
	0	13		3.7%	

Frequencies			
Groups	Points	Frequencies	Percent (%)
German as primary language at home (n = 407)	5	47	11.5%
	4	241	59.2%
	3	78	19.2%
	2	21	5.2%
	1	8	2.0%
	0	12	2.9%
Other language as primary language at home (n = 150)	5	21	14.0%
	4	53	35.3%
	3	38	25.3%
	2	24	16.0%
	1	5	3.3%
	0	9	6.0%
Secondary school completed in Germany (n = 492)	5	59	12.0%
	4	270	54.9%
	3	102	20.7%
	2	34	6.9%
	1	12	2.4%
	0	15	3.0%
Secondary school completed abroad (n = 68)	5	10	14.7%
	4	26	38.2%
	3	14	20.6%
	2	11	16.2%
	1	1	1.5%
	0	6	8.8%
Math not attended as advanced course in secondary school (n = 204)	5	34	16.7%
	4	75	36.8%
	3	54	26.5%
	2	23	11.3%
	1	9	4.4%
	0	9	4.4%
Math attended as advanced course in secondary school (n = 300)	5	30	10.0%
	4	197	65.7%
	3	47	15.7%
	2	16	5.3%
	1	3	1.0%
	0	7	2.3%
No math preparatory course attended (n = 251)	5	33	13.1%
	4	103	41.0%
	3	61	24.3%
	2	29	11.6%
	1	11	4.4%
	0	14	5.6%

Frequencies			
Groups	Points	Frequencies	Percent (%)
Math preparatory course attended (n = 304)	5	35	11.5%
	4	191	62.8%
	3	54	17.8%
	2	16	5.3%
	1	2	0.7%
	0	6	2.0%
University of applied sciences (n = 146)	5	21	14.4%
	4	55	37.7%
	3	33	22.6%
	2	20	13.7%
	1	7	4.8%
	0	10	6.8%
University (n = 419)	5	49	11.7%
	4	241	57.5%
	3	86	20.5%
	2	26	6.2%
	1	6	1.4%
	0	11	2.6%
Online Participation (n = 498)	5	56	14.1%
	4	197	49.5%
	3	91	22.9%
	2	33	8.3%
	1	9	2.3%
	0	12	3.0%
Pen-and-Paper Participation (n = 167)	5	14	8.4%
	4	99	59.3%
	3	28	16.8%
	2	13	7.8%
	1	4	2.4%
	0	9	5.4%
Attended Gymnasium (n = 403)	5	46	11.4%
	4	238	59.1%
	3	79	19.6%
	2	23	5.7%
	1	5	1.2%
	0	46	11.4%
Attended Other Secondary School (n = 145)	5	22	15.4%
	4	54	37.8%
	3	33	23.1%
	2	18	12.6%
	1	8	5.6%
	0	22	15.4%

Note. Due to missing values on demographics questions, frequencies within groups may not add up to the total number of responses.

Plots (PCS3)

All plots are generated from **Model A1**.

Item Information

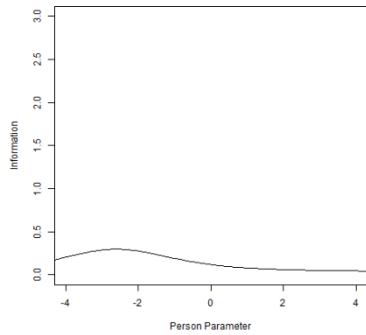

Expected Score

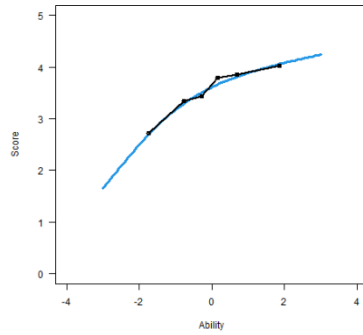

Probability

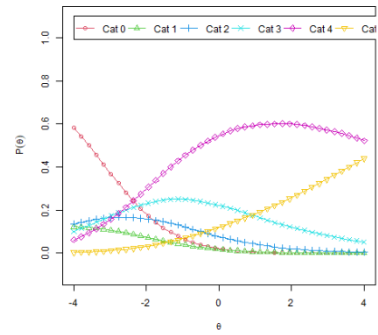

Note. The blue line represents expected performance, and the black line represents actual performance.

Note. Cat n = probability of receiving n points.

8.1.2. Decimal Representation (GR11)

Dezimaldarstellung

Welche der folgenden Zahlen ist die Dezimaldarstellung von $\frac{12}{55}$?

Wählen Sie die richtige Antwort.

A 0,0218

B 0,218

C 0,218

D 0,218

E 0,0218

Math Problem ID

GR11

Change

Problem was removed.

Reason for Change Made by Content Experts

This problem had a somewhat low factor loading, and its content was considered to be covered by other problems (GR1, GR3).

Correct Answers (PCS3)

Correct Answer	Number Correct Answers	Number Incorrect Answers ^a	Answer Frequencies					
			A	B	C	D	E	
blinded	blinded	blinded	blinded	blinded	blinded	blinded	blinded	blinded

Scoring (PCS3): Every correct response is worth one point (up to 1 point possible).

^a Includes cases, where the problem was seen but not answered.

Item Characteristics (PCS3)

Discrimination					
Measurement Type		Model A1	Model B	Model C	Model D
Correlation to participant ability (θ)		0.33	0.27	0.27	0.28
Discrimination Parameter (α)		0.60	0.54	0.54	0.60
Difficulty					
Measurement Type	Points	Model A1	Model B	Model C	Model D
Difficulty for participant of average ability level	1	-0.78	-0.88	-0.99	-0.80
	0	NA	NA	NA	NA
Cumulative probability for participant of average ability level	1	61.6%	61.6%	63.1%	61.7%
	0	100%	100%	100%	100%

Frequencies			
Groups	Points	Frequencies	Percent (%)
Complete sample for this math problem (n = 575)	1	352	61.2%
	0	223	38.8%
Female (n = 188)	1	104	55.3%
	0	84	44.7%
Male (n = 378)	1	241	63.8%
	0	137	36.2%
German as primary language at home (n = 426)	1	260	61.0%
	0	166	39.0%
Other language as primary language at home (n = 142)	1	86	60.6%
	0	56	39.4%
Secondary school completed in Germany (n = 505)	1	305	60.4%
	0	200	39.6%
Secondary school completed abroad (n = 65)	1	43	66.2%
	0	22	33.8%
Math not attended as advanced course in secondary school (n = 189)	1	103	54.5%
	0	86	45.5%
Math attended as advanced course in secondary school (n = 323)	1	209	64.7%
	0	114	35.3%
No math preparatory course attended (n = 270)	1	156	57.8%
	0	114	42.2%
Math preparatory course attended (n = 296)	1	188	63.5%
	0	108	36.5%
University of applied sciences (n = 146)	1	88	60.3%
	0	58	39.7%
University (n = 429)	1	264	61.5%
	0	165	38.5%
Online Participation (n = 407)	1	254	62.4%
	0	153	37.6%
Pen-and-Paper Participation (n = 168)	1	98	58.3%
	0	70	41.7%
Attended Gymnasium (n = 415)	1	261	62.9%
	0	154	37.1%
Attended Other Secondary School (n = 141)	1	79	56.0%
	0	62	44.0%

Note. Due to missing values on demographics questions, frequencies within groups may not add up to the total number of responses.

Plots (PCS3)

All plots are generated from **Model A1**.

Item Information

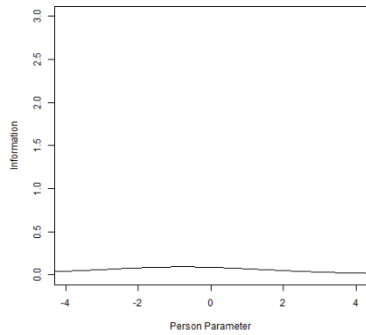

Expected Score

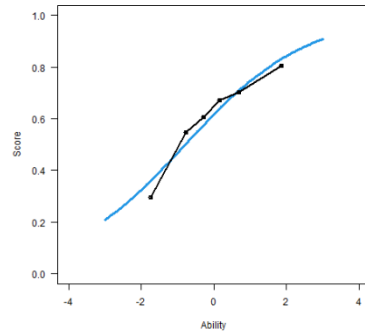

Note. The blue line represents expected performance, and the black line represents actual performance.

Probability

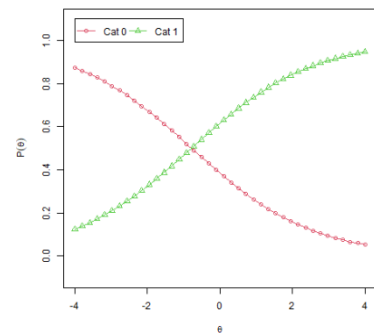

Note. Cat n = probability of receiving n points.

8.1.3. “Area – Indefinite?” (I8)

„Flächeninhalt – unbegrenzt?“

Bestimmen Sie das folgende Integral in Abhängigkeit des Parameters a .

Ergänzen Sie das freie Feld.

Schreibweise:
Nutzen Sie folgende Zeichen: + (Addition), - (Subtraktion), * (Multiplikation), / (Division), ^ (Potenz).

a)

$$\int_1^a x^{-2} dx = \text{[]}$$

b)

Je größer a wird, desto näher kommt das Integral dem Wert **1**. Welche Interpretation dieses mathematischen Sachverhalts trifft zu?

Wählen Sie eine oder mehrere richtige Antworten.

Ein solches Integral kann nicht als Flächeninhalt interpretiert werden.

Es handelt sich um ein sogenanntes uneigentliches Integral.

Der Wert beschreibt den Flächeninhalt bis zur Nullstelle der Funktion.

Der Flächeninhalt beträgt insgesamt nur **1**, auch wenn die beschriebene Fläche für a gegen unendlich kein Ende nimmt.

Math Problem ID

I8

Change

Problem Part “b)” was removed.

Reason for Change Made by Content Experts

The content of Part b) is only covered in advanced math courses in secondary school and not in regular courses so that curricular validity was not given.

Correct Answers (PCS3)

Math Problem Part	Correct Answer(s)	Number Correct Answers	Number Incorrect Answers	
a)	blinded	blinded	blinded	
Math Problem Part	Answer	Correct Answer(s)	Number Correct Answers	Number Incorrect Answers
b)	Ein solches Integral kann nicht als Flächeninhalt interpretiert werden.	blinded	blinded	blinded
	Es handelt sich um ein sogenanntes uneigentliches Integral.	blinded	blinded	blinded
	Der Wert beschreibt den Flächeninhalt bis zur Nullstelle der Funktion.	blinded	blinded	blinded
	Der Flächeninhalt beträgt insgesamt nur 1, auch wenn die beschriebene Fläche für a gegen unendlich kein Ende nimmt.	blinded	blinded	blinded

Scoring (PCS3): Correctly answering Part a) is worth one point. For Part b), correctly choosing/rejecting answer options 1, 2, and 3 is worth one point, and choosing Answer Option 4 is worth another point (up to 3 points possible).

Item Characteristics (PCS3)

Discrimination					
Measurement Type		Model A9	Model B	Model C	Model D
Correlation to participant ability (θ)		0.73	0.67	0.65	0.64
Discrimination Parameter (α)		1.22	1.08	0.80	1.18
Difficulty					
Measurement Type	Points	Model A9	Model B	Model C	Model D
Difficulty for participant of average ability level	3	1.77	1.87	2.14	1.79
	2	0.61	0.62	0.61	0.60
	1	-0.56	-0.62	-0.87	-0.59
	0	NA	NA	NA	NA
Cumulative probability for participant of average ability level	3	3.1%	3.9%	6.1%	3.4%
	2	25.0%	26.7%	31.5%	25.8%
	1	70.9%	71.0%	72.5%	71.4%
	0	100%	100%	100%	100%
Frequencies					
Groups	Points	Frequencies	Percent (%)		
Complete sample for this math problem (n = 533)	3	57	10.7%		
	2	127	23.8%		
	1	177	33.2%		
	0	172	32.3%		
Female (n = 184)	3	17	9.2%		
	2	36	19.6%		
	1	65	35.3%		
	0	66	35.9%		
Male (n = 341)	3	38	11.1%		
	2	90	26.4%		
	1	110	32.3%		
	0	103	30.2%		
German as primary language at home (n = 401)	3	51	12.7%		
	2	102	25.4%		
	1	137	34.2%		
	0	111	27.7%		
Other language as primary language at home (n = 132)	3	6	4.5%		
	2	25	18.9%		
	1	40	30.3%		
	0	61	46.2%		
Secondary school completed in Germany (n = 472)	3	54	11.4%		
	2	112	23.7%		
	1	157	33.3%		
	0	149	31.6%		

Frequencies			
Groups	Points	Frequencies	Percent (%)
Secondary school completed abroad (n = 60)	3	2	3.3%
	2	15	25.0%
	1	20	33.3%
	0	23	38.3%
Math not attended as advanced course in secondary school (n = 182)	3	4	2.2%
	2	16	8.8%
	1	63	34.6%
	0	99	54.4%
Math attended as advanced course in secondary school (n = 310)	3	52	16.8%
	2	102	32.9%
	1	99	31.9%
	0	57	18.4%
No math preparatory course attended (n = 236)	3	14	5.9%
	2	49	20.8%
	1	79	33.5%
	0	94	39.8%
Math preparatory course attended (n = 290)	3	42	14.5%
	2	77	26.6%
	1	97	33.4%
	0	74	25.5%
University of applied sciences (n = 134)	3	4	3.0%
	2	21	15.7%
	1	46	34.3%
	0	63	47.0%
University (n = 399)	3	53	13.3%
	2	106	26.6%
	1	131	32.8%
	0	109	27.3%
Online Participation (n = 369)	3	32	8.7%
	2	85	23.0%
	1	123	33.3%
	0	129	35.0%
Pen-and-Paper Participation (n = 164)	3	25	15.2%
	2	42	25.6%
	1	54	32.9%
	0	43	26.2%
Attended Gymnasium (n = 404)	3	51	12.6%
	2	107	26.5%
	1	141	34.9%
	0	105	26.0%
Attended Other Secondary School (n = 123)	3	6	4.9%
	2	19	15.4%
	1	35	28.5%
	0	63	51.2%

Note. Due to missing values on demographics questions, frequencies within groups may not add up to the total number of responses.

Plots (PCS3)

All plots are generated from **Model A9**.

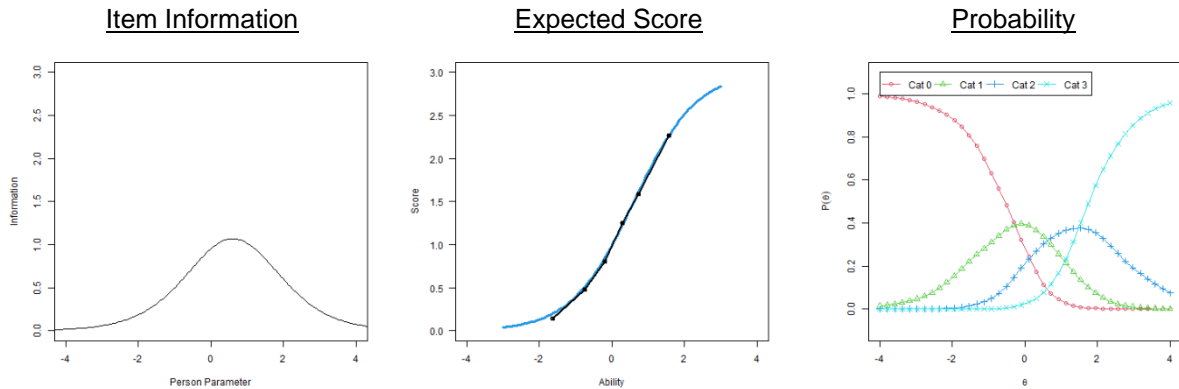

Note. The blue line represents expected performance, and the black line represents actual performance.

Note. Cat n = probability of receiving n points.

Differential Item Functioning (DIF in PCS3)

This problem shows DIF based on attending math as an advanced or regular course in high school. The difficulty (β) was significantly lower for those who attended math as an advanced course. This shows that the problem was significantly easier for those who attended math as an advanced course in high school.

Expected Score (math attended as advanced course in high school)

Expected Score (math not attended as advanced course in high school)

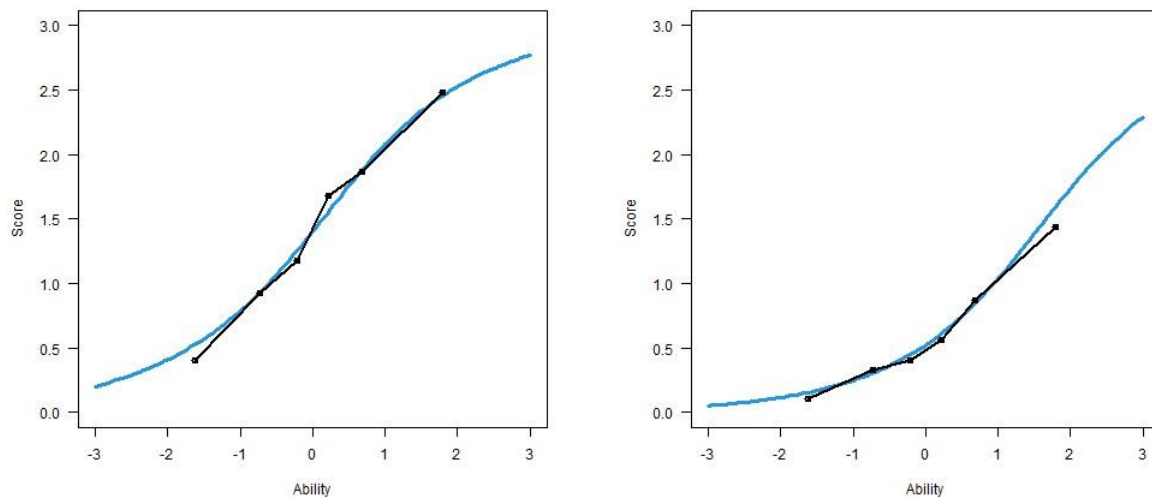

Note. The blue line represents expected performance, and the black line represents actual performance.

8.1.4. Linear Equation Systems for Lines (L12)

LGS einer Geraden

Gegeben sei ein lineares Gleichungssystem mit zwei Gleichungen und den Unbekannten x und y . Wenn das Gleichungssystem eine Gerade beschreibt, wie muss dann die Lösungsmenge aussehen?

Wählen Sie die richtige Antwort.

Die Lösung ist eine eindeutige Kombination von Werten für x und y . A

Es gibt keine Lösung. B

Die Lösung kann nur mit x in Abhängigkeit von y (oder umgekehrt) angegeben werden. C

Die Lösung enthält alle Kombinationen von Werten für x und y . D

Math Problem ID

L12

Change

Problem was removed.

Reason for Change Made by Content Experts

This problem had a low factor loading in all models, and its content was considered to be covered by other problems (L2, L6, L10).

Correct Answers (PCS3)

Correct Answer	Number Correct Answers	Number Incorrect Answers ^a	Answer Frequencies			
			A	B	C	D
blinded	blinded	blinded	blinded	blinded	blinded	blinded

Scoring (PCS3): Every correct response is worth one point (up to 1 point possible).

^a Includes cases, where the problem was seen but not answered.

Item Characteristics (PCS3)

Discrimination					
Measurement Type		Model A10	Model B	Model C	Model D
Correlation to participant ability (θ)		0.20	0.17	0.17	0.16
Discrimination Parameter (α)		0.34	0.30	0.30	0.32
Difficulty					
Measurement Type	Points	Model A10	Model B	Model C	Model D
Difficulty for participant of average ability level	1	0.59	0.59	0.47	0.57
	0	NA	NA	NA	NA
Cumulative probability for participant of average ability level	1	45.0%	45.6%	46.5%	45.5%
	0	100%	100%	100%	100%
Frequencies					
Groups	Points	Frequencies		Percent (%)	
Complete sample for this math problem (n = 542)	1	245		45.2%	
	0	297		54.8%	
Female (n = 187)	1	70		37.4%	
	0	117		62.6%	
Male (n = 342)	1	170		49.7%	
	0	172		50.3%	
German as primary language at home (n = 398)	1	192		48.2%	
	0	206		51.8%	
Other language as primary language at home (n = 138)	1	51		37.0%	
	0	87		63.0%	
Secondary school completed in Germany (n = 481)	1	220		45.7%	
	0	261		54.3%	
Secondary school completed abroad (n = 58)	1	24		41.4%	
	0	34		58.6%	
Math not attended as advanced course in secondary school (n = 196)	1	81		41.3%	
	0	115		58.7%	
Math attended as advanced course in secondary school (n = 284)	1	135		47.5%	
	0	149		52.5%	
No math preparatory course attended (n = 246)	1	107		43.5%	
	0	139		56.5%	
Math preparatory course attended (n = 286)	1	133		46.5%	
	0	153		53.5%	
University of applied sciences (n = 142)	1	64		45.1%	
	0	78		54.9%	
University (n = 400)	1	181		45.3%	
	0	219		54.8%	
Online Participation (n = 381)	1	184		48.3%	
	0	197		51.7%	
Pen-and-Paper Participation (n = 161)	1	61		37.9%	
	0	100		62.1%	

Frequencies			
Groups	Points	Frequencies	Percent (%)
Attended Gymnasium (n = 383)	1	179	46.7%
	0	204	53.3%
Attended Other Secondary School (n = 148)	1	62	41.9%
	0	86	58.1%

Note. Due to missing values on demographics questions, frequencies within groups may not add up to the total number of responses.

Plots (PCS3)

All plots are generated from **Model A10**.

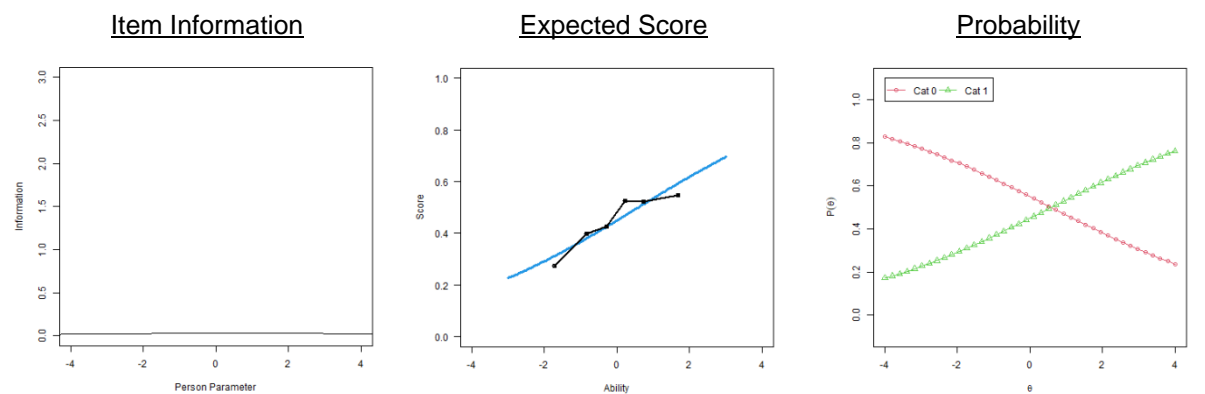

Note. The blue line represents expected performance, and the black line represents actual performance.

Note. Cat n = probability of receiving n points.

8.2. R Scripts

8.2.1. Script for Data Import

```
#####Data Import and cleaning
###Data Version 34
##this script imports data from SPSS and creates data frames for use in analyses
#Libraries#####
library(foreign) #this library is needed to read spss data sets
library(pairwise) #Pairwise is only used for ftab function as verification

##Import and clean data#####
d0<-read.spss("IRT EXPORT PC1 vFinal2.sav",to.data.frame=T,use.value.labels = F)

##d1 is partial credit version 1#####
names(d0) #Check names and column numbers
d1<-d0[514:632] #adjust for correct column numbers

#filter out unused cases and check numbers
d1<-d1[which(d0$CaseType<=1),]
nrow(d0[which(d0$CaseType<=1),])

##3213 cases are included in analyses
#this is the number who answered at least one math problem correctly.
##This is created for a valid comparison group
d0_Trimmed<-d0[which(d0$CaseType<=1),]
table(d0_Trimmed$Group)

##Make frames for individual scale analyses#####
PC_EF<-d1[1:10]
PC_TR<-d1[11:20]
PC_TG<-d1[21:30]
PC_G<-d1[31:40]
PC_D<-d1[41:51]
PC_V<-d1[52:64]
PC_I<-d1[65:74]
PC_HF<-d1[75:84]
PC_GR<-d1[85:97]
PC_L<-d1[98:109]
PC_P<-d1[110:119]
#check freq. tables
#check for unusual sums and verify names have been converted correctly.
ftab(PC_EF)
ftab(PC_TR)
ftab(PC_TG)
ftab(PC_G)
ftab(PC_D)
ftab(PC_V)
ftab(PC_I)
ftab(PC_HF)
ftab(PC_GR)
ftab(PC_L)
ftab(PC_P)

###Useful values to export to IRT analyses
##List of Items
items <- names(d1)
##List of constructs each item belongs to#
maxk <- max(unlist(d1), na.rm = TRUE)
constructs <- gsub("(PC_)([[:alpha:]]+)([[:digit:]]+)$", "\\2", items)
```

```

##Person IDs
pid <- d0$ID[which(d0$CaseType<=1 & d0$CaseType2<2)]
demo_d1<-d0[1:111]
demo_d1<-demo_d1[which(d0$CaseType<=1 & d0$CaseType2<2),]

####Get data for PC vers 2.####
d0PC2 <-read.spss("IRT EXPORT PC2 vFinal2.sav",to.data.frame=T,use.value.labels = F)
names(d0PC2) #Check names and column numbers
d2<-d0PC2[514:632] #adjust for correct column numbers

#filter out unused cases and check numbers
d2<-d2[which(d0PC2$CaseType<=1 & d0PC2$CaseType2<2),]
nrow(d0[which(d0PC2$CaseType<=1 & d0PC2$CaseType2<2),])

##Make frames for individual scale analyses####
PC_EF_PC2<-d2[1:10]
PC_TR_PC2<-d2[11:20]
PC_TG_PC2<-d2[21:30]
PC_G_PC2<-d2[31:40]
PC_D_PC2<-d2[41:51]
PC_V_PC2<-d2[52:64]
PC_I_PC2<-d2[65:74]
PC_HF_PC2<-d2[75:84]
PC_GR_PC2<-d2[85:97]
PC_L_PC2<-d2[98:109]
PC_P_PC2<-d2[110:119]
#check freq. tables
#check for unusual sums and verify names have been converted correctly.
ftab(PC_EF_PC2)
ftab(PC_TR_PC2)
ftab(PC_TG_PC2)
ftab(PC_G_PC2)
ftab(PC_D_PC2)
ftab(PC_V_PC2)
ftab(PC_I_PC2)
ftab(PC_HF_PC2)
ftab(PC_GR_PC2)
ftab(PC_L_PC2)
ftab(PC_P_PC2)

####Get data for PC vers 3.####
d0PC3<-read.spss("IRT EXPORT PC3 vFinal2.sav",to.data.frame=T,use.value.labels = F)
d0PC3<-d0PC3[which(d0PC2$CaseType<=1 & d0PC2$CaseType2<2),]
d3<-d2

##Test all changes on model A
d3$PC_D11<-d0PC3$PC_D11_ALT
d3$PC_D7<-d0PC3$PC_D7_ALT
d3$PC_I1<-d0PC3$PC_I1_ALT
d3$PC_I8<-d0PC3$PC_I8_ALT
d3$PC_L2<-d0PC3$PC_L2_ALT
d3$PC_TG9<-d0PC3$PC_TG9_ALT
d3$PC_V4<-d0PC3$PC_V4_ALT
d3$PC_V11<-d0PC3$PC_V11_Alt
d3$PC_L2<-d0PC3$PC_L2_ALT
d3$PC_L4<-d0PC3$PC_L4_ALT

PC_EF_PC3<-d3[1:10]
PC_TR_PC3<-d3[11:20]

```

```
PC_TG_PC3<-d3[21:30]
PC_G_PC3<-d3[31:40]
PC_D_PC3<-d3[41:51]
PC_V_PC3<-d3[52:64]
PC_I_PC3<-d3[65:74]
PC_HF_PC3<-d3[75:84]
PC_GR_PC3<-d3[85:97]
PC_L_PC3<-d3[98:109]
PC_P_PC3<-d3[110:119]
```

```
ftab(PC_EF_PC3)
ftab(PC_TR_PC3)
ftab(PC_TG_PC3)
ftab(PC_G_PC3)
ftab(PC_D_PC3)
ftab(PC_V_PC3)
ftab(PC_I_PC3)
ftab(PC_HF_PC3)
ftab(PC_GR_PC3)
ftab(PC_L_PC3)
ftab(PC_P_PC3)
```

```
##Export D3 to create tables in report####
write.csv(d0_Trimmed,"d0_Trimmed.csv")
write.csv(d3, "d3.csv")
```

```
####Data Version 4####
##Includes Select modifications to Problems and Items
d4<-d3
```

```
#Delete 3 problems
d4$PC_GR11<-NULL
d4$PC_L12<-NULL
#Delete I8, part b
d4$PC_I8<-d0_Trimmed$C1_I8.1_1
#Fix GR9
table(d4$PC_GR9)
d4$PC_GR9<-rowSums(cbind(d0_Trimmed$C1_GR9_1,
                        d0_Trimmed$C1_GR9_2,
                        d0_Trimmed$C1_GR9_3,
                        d0_Trimmed$C1_GR9_4))
table(d4$PC_GR9)
```

```
summary(d4$PC_GR11)
summary(d4$L12)
summary(d4$TR2)
summary(d4$PC_I8)
summary(d3$PC_I8)
summary(d4$PC_GR9)
```

```
##Create Subscales
names(d4)
```

```
PC_EF_PC4<-d4[1:10]
PC_TR_PC4<-d4[11:20]
PC_TG_PC4<-d4[21:30]
PC_G_PC4<-d4[31:40]
PC_D_PC4<-d4[41:51]
PC_V_PC4<-d4[52:64]
PC_I_PC4<-d4[65:74]
PC_HF_PC4<-d4[75:84]
```



```
PC_GR_PC4<-d4[85:96]
PC_L_PC4<-d4[97:107]
PC_P_PC4<-d4[108:117]
```

```
ftab(d4)
ftab(PC_EF_PC4)
ftab(PC_TR_PC4)
ftab(PC_TG_PC4)
ftab(PC_G_PC4)
ftab(PC_D_PC4)
ftab(PC_V_PC4)
ftab(PC_I_PC4)
ftab(PC_HF_PC4)
ftab(PC_GR_PC4)
ftab(PC_L_PC4)
ftab(PC_P_PC4)
```

```
#Items and constructs in PC4
```

```
items_PC4 <- names(d4)
```

```
constructs_PC4 <- gsub("^PC_)([[:alpha:]]+)([[:digit:]]+)$", "\\2", items_PC4)
```

```
#export d4
```

```
write.csv(d4,"D4_Trimmed.csv")
```

```
pairwise::ftab(d4)
```

```
x<-pairwise::ftab(d4)
```

```
write.csv(x,"temp.csv")
```

8.2.2. Script for Base PCS4-Models

```
#####This script builds models for PC4
##Other models are calculated the same way, but with different versions of the data
##e.g., PC1, PC2, or PC3 – which are created in the data import script (see Section 8.2.1)
##Exports are Thurstonian thresholds,
#       Alpha values
#       Point-Biserial correlations
#       Q3 statistics
#       Item Probability curves

##Libraries and backbone#####
library(TAM)
tam_ctrl <- list(nodes = seq(-6, 6, len = 21),
               snodes = 0, QMC = TRUE,
               Msteps = 4,
               increment.factor = 1, fac.oldxsi = 0, acceleration = "none"
)
tam_ctrl$increment.factor <- 1.05

##NOTE see script "OldModels.R" for modles PC1-3
#####Models A1-A11#####
##A1. Grundrechenarten
GPCM_A1_PC4 <- tam.mml.2pl(PC_GR_PC4,irtmodel="GPCM",control=tam_ctrl,pid=pid)
WLE_A1_PC4<-tam.wle(GPCM_A1_PC4)
GPCM_A1_PC4
##A2. Potenzen, Wurzeln, Logarithmen
GPCM_A2_PC4 <- tam.mml.2pl(PC_P_PC4,irtmodel="GPCM",control=tam_ctrl,pid=pid)
WLE_A2_PC4<-tam.wle(GPCM_A2_PC4)
GPCM_A2_PC4
##A3. Terme und Gleichungen
GPCM_A3_PC4 <- tam.mml.2pl(PC_TG_PC4,irtmodel="GPCM",control=tam_ctrl,pid=pid)
WLE_A3_PC4<-tam.wle(GPCM_A3_PC4)
GPCM_A3_PC4
##A4. Elementare Funktionen
GPCM_A4_PC4 <- tam.mml.2pl(PC_EF_PC4,irtmodel="GPCM",control=tam_ctrl,pid=pid)
WLE_A4_PC4<-tam.wle(GPCM_A4_PC4)
GPCM_A4_PC4
##A5. Elementare Geometrie
GPCM_A5_PC4 <- tam.mml.2pl(PC_G_PC4,irtmodel="GPCM",control=tam_ctrl,pid=pid)
WLE_A5_PC4<-tam.wle(GPCM_A5_PC4)
GPCM_A5_PC4
##A6. Trigonometrie
GPCM_A6_PC4 <- tam.mml.2pl(PC_TR_PC4,irtmodel="GPCM",control=tam_ctrl,pid=pid)
WLE_A6_PC4 <-tam.wle(GPCM_A6_PC4)
GPCM_A6_PC4
##A7. Höhere Funktionen
GPCM_A7_PC4 <- tam.mml.2pl(PC_HF_PC4,irtmodel="GPCM",control=tam_ctrl,pid=pid)
WLE_A7_PC4<-tam.wle(GPCM_A7_PC4)
GPCM_A7_PC4
##A8. Differentialrechnung
GPCM_A8_PC4 <- tam.mml.2pl(PC_D_PC4,irtmodel="GPCM",control=tam_ctrl,pid=pid)
WLE_A8_PC4<-tam.wle(GPCM_A8_PC4)
GPCM_A8_PC4
##A9. Integralrechnung
GPCM_A9_PC4 <- tam.mml.2pl(PC_I_PC4,irtmodel="GPCM",control=tam_ctrl,pid=pid)
WLE_A9_PC4<-tam.wle(GPCM_A9_PC4)
```

```

GPCM_A9_PC4
##A10. Lineare Gleichungssysteme
GPCM_A10_PC4 <- tam.mml.2pl(PC_L_PC4,irtmodel="GPCM",control=tam_ctrl,pid=pid)
WLE_A10_PC4<-tam.wle(GPCM_A10_PC4)
GPCM_A10_PC4
##A11. Vektoren und Analytische Geomtrie
GPCM_A11_PC4 <- tam.mml.2pl(PC_V_PC4,irtmodel="GPCM",control=tam_ctrl,pid=pid)
WLE_A11_PC4<-tam.wle(GPCM_A11_PC4)
GPCM_A11_PC4

##Model B (Unidimensional no constraints)####
##Crate Model B##
GPCM_B_PC4 <- tam.mml.2pl(d4,irtmodel="GPCM",control=tam_ctrl,pid=pid)
##WLE for Model B#
WLE_B_PC4<-tam.wle(GPCM_B_PC4)

##Model C (Unidimensional, constrained equal alpha sums for each scale)####
#tweak controls
this_tam_ctrl <- tam_ctrl
this_tam_ctrl$fac.oldxsi <- .8
this_tam_ctrl$Msteps <- 5
this_tam_ctrl$acceleration <- "Ramsay"

# constrain slope parameters to sum up to the number of items
# within a given construct
gammaslope.constr.V <- matrix(0, nrow = length(items_PC4),
                             ncol = length(unique(constructs_PC4)),
                             dimnames = list(items_PC4, unique(constructs_PC4)))
gammaslope.constr.c <- setNames(vector(length = length(unique(constructs_PC4))),
                               unique(constructs_PC4))

for(dd in unique(constructs)){
  gammaslope.constr.V[constructs_PC4 == dd, dd] <- 1
  gammaslope.constr.c[dd] <- 11
##total weight of the items of a subdomain equal accross all subdomains
}
#Model
GPCM_C_PC4 <- tam.mml.3pl(d4[, items_PC4],
                        pid = pid,
                        est.variance = TRUE,
                        gammaslope.constr.V = gammaslope.constr.V,
                        gammaslope.constr.c = gammaslope.constr.c,
                        gammaslope.des = "2PL",
                        control = this_tam_ctrl)

#Confirm equal weights
cbind(aggregate(data.frame("estimates" = GPCM_C_PC4$gammaslope), list(constructs_PC4), sum),
      "target" = unname(gammaslope.constr.c[order(names(gammaslope.constr.c))]))
#WLE
WLE_C_PC4<-tam.mml.wle(GPCM_C_PC4)

##Model D - PC4####
##Full 11 dimensional model
Q <- matrix(0, nrow = length(items_PC4), ncol = length(unique(constructs_PC4)),
            dimnames = list(items_PC4, sort(unique(constructs_PC4))))
Q[cbind(1:length(items_PC4), match(constructs_PC4, colnames(Q)))] <- 1

```

```
beta.fixed <- rbind(cbind("group" = 1, "dim" = 1:ncol(Q), "value" = 0))
fixed_cov <- diag(1, ncol(Q))
variance.fixed <- cbind("group" = 1,
  "dim" = which(lower.tri(fixed_cov, diag = TRUE), arr.ind = TRUE),
  "value" = fixed_cov[lower.tri(fixed_cov, diag = TRUE)]
)
##Build Model & Make presets##
tam_ctrl <- list(nodes = seq(-6, 6, len = 21),
  snodes = 0, QMC = TRUE,
  Msteps = 4,
  increment.factor = 1, fac.oldxsi = 0, acceleration = "none"
)
tam_ctrl$increment.factor <- 1.05

remove_cat_vars <- function(x, k) {
  setdiff(x, miceadds::grep.vec(paste0("Cat", k), x, "OR")$x)
}
tam_ctrl$snodes <- 10000 ##10,000 integration nodes

tam_ctrl$acceleration <- "Ramsay"

GPCM_D_PC4 <- tam.mml.2pl(d4, # very demanding (even with only 2000 integration points)
  pid = pid,
  Q = Q,
  irtmodel = "GPCM",
  est.variance = FALSE, # default est.variance = FALSE
  control = tam_ctrl)
WLE_D_PC4 <- tam.wle(GPCM_D_PC4)

GPCM_D_PC4$iter
Q

##Export Model Characteristics####
#Thresholds
#Models A
write.csv(tam.threshold(GPCM_A1_PC4), "GPCM_A1_PC4_Thresholds.csv")
write.csv(tam.threshold(GPCM_A2_PC4), "GPCM_A2_PC4_Thresholds.csv")
write.csv(tam.threshold(GPCM_A3_PC4), "GPCM_A3_PC4_Thresholds.csv")
write.csv(tam.threshold(GPCM_A4_PC4), "GPCM_A4_PC4_Thresholds.csv")
write.csv(tam.threshold(GPCM_A5_PC4), "GPCM_A5_PC4_Thresholds.csv")
write.csv(tam.threshold(GPCM_A6_PC4), "GPCM_A6_PC4_Thresholds.csv")
write.csv(tam.threshold(GPCM_A7_PC4), "GPCM_A7_PC4_Thresholds.csv")
write.csv(tam.threshold(GPCM_A8_PC4), "GPCM_A8_PC4_Thresholds.csv")
write.csv(tam.threshold(GPCM_A9_PC4), "GPCM_A9_PC4_Thresholds.csv")
write.csv(tam.threshold(GPCM_A10_PC4), "GPCM_A10_PC4_Thresholds.csv")
write.csv(tam.threshold(GPCM_A11_PC4), "GPCM_A11_PC4_Thresholds.csv")

#model B
write.csv(tam.threshold(GPCM_B_PC4), "GPCM_B_PC4_Thresholds.csv")

#Model C
write.csv(tam.threshold(GPCM_C_PC4), "GPCM_C_PC4_Thresholds.csv")

#Model D
write.csv(tam.threshold(GPCM_D_PC4), "GPCM_D_PC4_Thresholds.csv")
```

```

##Alphas
#Models A
Alpha_A1_PC4<-cbind(GPCM_A1_PC4$item_irt$alpha,names(PC_GR_PC4))
write.csv(Alpha_A1_PC4, "alphas_A1.csv")
Alpha_A2_PC4<-cbind(GPCM_A2_PC4$item_irt$alpha,names(PC_P_PC4))
write.csv(Alpha_A2_PC4, "alphas_A2.csv")
Alpha_A3_PC4<-cbind(GPCM_A3_PC4$item_irt$alpha,names(PC_TG_PC4))
write.csv(Alpha_A3_PC4, "alphas_A3.csv")
Alpha_A4_PC4<-cbind(GPCM_A4_PC4$item_irt$alpha,names(PC_EF_PC4))
write.csv(Alpha_A4_PC4, "alphas_A4.csv")
Alpha_A5_PC4<-cbind(GPCM_A5_PC4$item_irt$alpha,names(PC_G_PC4))
write.csv(Alpha_A5_PC4, "alphas_A5.csv")
Alpha_A6_PC4<-cbind(GPCM_A6_PC4$item_irt$alpha,names(PC_TR_PC4))
write.csv(Alpha_A6_PC4, "alphas_A6.csv")
Alpha_A7_PC4<-cbind(GPCM_A7_PC4$item_irt$alpha,names(PC_HF_PC4))
write.csv(Alpha_A7_PC4, "alphas_A7.csv")
Alpha_A8_PC4<-cbind(GPCM_A8_PC4$item_irt$alpha,names(PC_D_PC4))
write.csv(Alpha_A8_PC4, "alphas_A8.csv")
Alpha_A9_PC4<-cbind(GPCM_A9_PC4$item_irt$alpha,names(PC_I_PC4))
write.csv(Alpha_A9_PC4, "alphas_A9.csv")
Alpha_A10_PC4<-cbind(GPCM_A10_PC4$item_irt$alpha,names(PC_L_PC4))
write.csv(Alpha_A10_PC4, "alphas_A10.csv")
Alpha_A11_PC4<-cbind(GPCM_A11_PC4$item_irt$alpha,names(PC_V_PC4))
write.csv(Alpha_A11_PC4, "alphas_A11.csv")
#Model B
Alphas_Model_B<-cbind(GPCM_B_PC4$item_irt$alpha,names(d4))
write.csv(Alphas_Model_B, "alphas_B_PC4.csv")
#Model C
Alphas_Model_C<-cbind(GPCM_C_PC4$item_irt$alpha,names(d4))
write.csv(Alphas_Model_C, "alphas_C_PC4.csv")
#Model D
Alpha_D_PC4<-as.data.frame(cbind(rowSums(GPCM_D_PC4$B[,2,]),names(d4)))
write.csv(Alpha_D_PC4, "alphas_D_PC4.csv")

```

##Biserial Correlations####

```

#Models A
x<-0
for(i in 1:ncol(PC_GR_PC4)) x[i]<-
cor(PC_GR_PC4[i],WLE_A1_PC4$theta,use="pairwise.complete.obs")
names(x)<-names(PC_GR_PC4)
write.csv(x,"A1_BiCor.csv")
x<-0
for(i in 1:ncol(PC_P_PC4)) x[i]<-cor(PC_P_PC4[i],WLE_A2_PC4$theta,use="pairwise.complete.obs")
names(x)<-names(PC_P_PC4)
write.csv(x,"A2_BiCor.csv")
x<-0
for(i in 1:ncol(PC_TG_PC4)) x[i]<-
cor(PC_TG_PC4[i],WLE_A3_PC4$theta,use="pairwise.complete.obs")
names(x)<-names(PC_TG_PC4)
write.csv(x,"A3_BiCor.csv")
x<-0
for(i in 1:ncol(PC_EF_PC4)) x[i]<-
cor(PC_EF_PC4[i],WLE_A4_PC4$theta,use="pairwise.complete.obs")
names(x)<-names(PC_EF_PC4)
write.csv(x,"A4_BiCor.csv")
x<-0

```

```

for(i in 1:ncol(PC_G_PC4)) x[i]<-cor(PC_G_PC4[i],WLE_A5_PC4$theta,use="pairwise.complete.obs")
names(x)<-names(PC_G_PC4)
write.csv(x,"A5_BiCor.csv")
x<-0
for(i in 1:ncol(PC_TR_PC4)) x[i]<-
cor(PC_TR_PC4[i],WLE_A6_PC4$theta,use="pairwise.complete.obs")
names(x)<-names(PC_TR_PC4)
write.csv(x,"A6_BiCor.csv")
x<-0
for(i in 1:ncol(PC_HF_PC4)) x[i]<-
cor(PC_HF_PC4[i],WLE_A7_PC4$theta,use="pairwise.complete.obs")
names(x)<-names(PC_HF_PC4)
write.csv(x,"A7_BiCor.csv")
x<-0
for(i in 1:ncol(PC_D_PC4)) x[i]<-cor(PC_D_PC4[i],WLE_A8_PC4$theta,use="pairwise.complete.obs")
names(x)<-names(PC_D_PC4)
write.csv(x,"A8_BiCor.csv")
x<-0
for(i in 1:ncol(PC_I_PC4)) x[i]<-cor(PC_I_PC4[i],WLE_A9_PC4$theta,use="pairwise.complete.obs")
names(x)<-names(PC_I_PC4)
write.csv(x,"A9_BiCor.csv")
x<-0
for(i in 1:ncol(PC_L_PC4)) x[i]<-cor(PC_L_PC4[i],WLE_A10_PC4$theta,use="pairwise.complete.obs")
names(x)<-names(PC_L_PC4)
write.csv(x,"A10_BiCor.csv")
x<-0
for(i in 1:ncol(PC_V_PC4)) x[i]<-cor(PC_V_PC4[i],WLE_A11_PC4$theta,use="pairwise.complete.obs")
names(x)<-names(PC_V_PC4)
write.csv(x,"A11_BiCor.csv")

#Model B
x<-0
for(i in 1:ncol(d4)){ x[i]<-cor(d4[i],WLE_B_PC4$theta,use="pairwise.complete.obs")}
names(x)<-names(d4)
write.csv(x,"B_BiCor.csv")

#Model C
x<-0
for(i in 1:ncol(d4)){ x[i]<-cor(d4[i],WLE_C_PC4$theta,use="pairwise.complete.obs")}
names(x)<-names(d4)
write.csv(x,"C_BiCor.csv")

#model D
#Note Model D uses simplified equal weights calculation
x<-0
for(i in 1:ncol(d4)){ x[i]<-
cor(d4[i],rowMeans(WLE_D_PC4[25:35],na.rm=T),use="pairwise.complete.obs")}
names(x)<-names(d4)
write.csv(x,"D_BiCor.csv")

####Q3 matrix####
Q3_A1<-tam.Q3(GPCM_A1_PC4)
Q3_A2<-tam.Q3(GPCM_A2_PC4)
Q3_A3<-tam.Q3(GPCM_A3_PC4)
Q3_A4<-tam.Q3(GPCM_A4_PC4)
Q3_A5<-tam.Q3(GPCM_A5_PC4)
Q3_A6<-tam.Q3(GPCM_A6_PC4)

```

```
Q3_A7<-tam.Q3(GPCM_A7_PC4)
Q3_A8<-tam.Q3(GPCM_A8_PC4)
Q3_A9<-tam.Q3(GPCM_A9_PC4)
Q3_A10<-tam.Q3(GPCM_A10_PC4)
Q3_A11<-tam.Q3(GPCM_A11_PC4)

write.csv(Q3_A1$Q3.matr,"Q3_A1.csv")
write.csv(Q3_A2$Q3.matr,"Q3_A2.csv")
write.csv(Q3_A3$Q3.matr,"Q3_A3.csv")
write.csv(Q3_A4$Q3.matr,"Q3_A4.csv")
write.csv(Q3_A5$Q3.matr,"Q3_A5.csv")
write.csv(Q3_A6$Q3.matr,"Q3_A6.csv")
write.csv(Q3_A7$Q3.matr,"Q3_A7.csv")
write.csv(Q3_A8$Q3.matr,"Q3_A8.csv")
write.csv(Q3_A9$Q3.matr,"Q3_A9.csv")
write.csv(Q3_A10$Q3.matr,"Q3_A10.csv")
write.csv(Q3_A11$Q3.matr,"Q3_A11.csv")

###Extract probabilities @theta = 0 ####

A1_Probs<-IRT.irfprob(GPCM_A1_PC4)
A1_Probs[,11]

A2_Probs<-IRT.irfprob(GPCM_A2_PC4)
A2_Probs[,11]

A3_Probs<-IRT.irfprob(GPCM_A3_PC4)
A3_Probs[,11]

A4_Probs<-IRT.irfprob(GPCM_A4_PC4)
A4_Probs[,11]

A5_Probs<-IRT.irfprob(GPCM_A5_PC4)
A5_Probs[,11]

A6_Probs<-IRT.irfprob(GPCM_A6_PC4)
A6_Probs[,11]

A7_Probs<-IRT.irfprob(GPCM_A7_PC4)
A7_Probs[,11]

A8_Probs<-IRT.irfprob(GPCM_A8_PC4)
A8_Probs[,11]

A9_Probs<-IRT.irfprob(GPCM_A9_PC4)
A9_Probs[,11]

A10_Probs<-IRT.irfprob(GPCM_A10_PC4)
A10_Probs[,11]

A11_Probs<-IRT.irfprob(GPCM_A11_PC4)
A11_Probs[,11]

B_Probs<-IRT.irfprob(GPCM_B_PC4)
B_Probs[,11]
```

```
C_Probs<-IRT.irfprob(GPCM_C_PC4)
C_Probs[,11]
```

```
A_Probs<-list(
  A1_Probs[,11],
  A2_Probs[,11],
  A3_Probs[,11],
  A4_Probs[,11],
  A5_Probs[,11],
  A6_Probs[,11],
  A7_Probs[,11],
  A8_Probs[,11],
  A9_Probs[,11],
  A10_Probs[,11],
  A11_Probs[,11])
```

```
##Syntax for model D taken from Thomas Kiefer's suggestion
##alter call to force similar to other functions so we are not using the integration nodes
res <- with(GPCM_D_PC4,
  TAM:::tam_mml_calc_prob(
    ilindex = 1:nitems, A = A, AXsi = AXsi, B = B, xsi = xsi,
    theta = matrix(0, ncol = 11), nnodes = 1,
    maxK = maxK, recalc = FALSE,
    maxcat = apply(GPCM_D_PC4$resp, 2, max, na.rm = TRUE) + 1,
    use_rcpp = TRUE)
)
```

```
D_Probs<-res$rprobs
res<-NULL
```

```
for (i in 1:11){
  write.csv(A_Probs[i], paste("A",i,"_Probs.csv",sep=""))}
write.csv(B_Probs[,11],"B_Probs.csv")
write.csv(C_Probs[,11],"C_Probs.csv")
write.csv(D_Probs,"D_Probs.csv")
```

```
##Model D subscale correlation matrix
temp<-as.data.frame(GPCM_D_PC4$variance)
names(temp)<-c("D","EF","G","GR", "HF", "I", "L", "P", "TG", "TR", "V")
write.csv(temp,"D_CorMat.csv")
```

```
table(d0_Trimmed$LinkConsent,d0_Trimmed$Group)
```

8.2.3. Script to Calculate PV and Theta Values

```
###Get Thetas and PVs
library(TAM)
##This file gets thetas and PVs for Partial Credit Scoring version 3 PCS3
###PCS4####

##For model A, PVs are only estimated if the participant was assigned a booklet that contained it
#A1
A1_PC4_Theta_PV<-as.data.frame(cbind(WLE_A1_PC4$pid,WLE_A1_PC4$theta))
temp<-tam.pv(GPCM_A1_PC4)$pv[2:11]
A1_PC4_Theta_PV<-cbind(A1_PC4_Theta_PV,temp)
names(A1_PC4_Theta_PV)<-c("ID","A1_Theta","A1_PV1","A1_PV2","A1_PV3","A1_PV4",
"A1_PV5","A1_PV6",
"A1_PV7","A1_PV8","A1_PV9","A1_PV10")
A1_PC4_Theta_PV[3:12][which(is.na(A1_PC4_Theta_PV[2])),]<-NA
#A2
A2_PC4_Theta_PV<-as.data.frame(cbind(WLE_A2_PC4$pid,WLE_A2_PC4$theta))
temp<-tam.pv(GPCM_A2_PC4)$pv[2:11]
A2_PC4_Theta_PV<-cbind(A2_PC4_Theta_PV,temp)
names(A2_PC4_Theta_PV)<-c("ID","A2_Theta","A2_PV1","A2_PV2","A2_PV3","A2_PV4",
"A2_PV5","A2_PV6",
"A2_PV7","A2_PV8","A2_PV9","A2_PV10")
A2_PC4_Theta_PV[3:12][which(is.na(A2_PC4_Theta_PV[2])),]<-NA
#A3
A3_PC4_Theta_PV<-as.data.frame(cbind(WLE_A3_PC4$pid,WLE_A3_PC4$theta))
temp<-tam.pv(GPCM_A3_PC4)$pv[2:11]
A3_PC4_Theta_PV<-cbind(A3_PC4_Theta_PV,temp)
names(A3_PC4_Theta_PV)<-c("ID","A3_Theta","A3_PV1","A3_PV2","A3_PV3","A3_PV4",
"A3_PV5","A3_PV6",
"A3_PV7","A3_PV8","A3_PV9","A3_PV10")
A3_PC4_Theta_PV[3:12][which(is.na(A3_PC4_Theta_PV[2])),]<-NA
#A4
A4_PC4_Theta_PV<-as.data.frame(cbind(WLE_A4_PC4$pid,WLE_A4_PC4$theta))
temp<-tam.pv(GPCM_A4_PC4)$pv[2:11]
A4_PC4_Theta_PV<-cbind(A4_PC4_Theta_PV,temp)
names(A4_PC4_Theta_PV)<-c("ID","A4_Theta","A4_PV1","A4_PV2","A4_PV3","A4_PV4",
"A4_PV5","A4_PV6",
"A4_PV7","A4_PV8","A4_PV9","A4_PV10")
A4_PC4_Theta_PV[3:12][which(is.na(A4_PC4_Theta_PV[2])),]<-NA
#A5
A5_PC4_Theta_PV<-as.data.frame(cbind(WLE_A5_PC4$pid,WLE_A5_PC4$theta))
temp<-tam.pv(GPCM_A5_PC4)$pv[2:11]
A5_PC4_Theta_PV<-cbind(A5_PC4_Theta_PV,temp)
names(A5_PC4_Theta_PV)<-c("ID","A5_Theta","A5_PV1","A5_PV2","A5_PV3","A5_PV4",
"A5_PV5","A5_PV6",
"A5_PV7","A5_PV8","A5_PV9","A5_PV10")
A5_PC4_Theta_PV[3:12][which(is.na(A5_PC4_Theta_PV[2])),]<-NA
#A6
A6_PC4_Theta_PV<-as.data.frame(cbind(WLE_A6_PC4$pid,WLE_A6_PC4$theta))
temp<-tam.pv(GPCM_A6_PC4)$pv[2:11]
A6_PC4_Theta_PV<-cbind(A6_PC4_Theta_PV,temp)
names(A6_PC4_Theta_PV)<-c("ID","A6_Theta","A6_PV1","A6_PV2","A6_PV3","A6_PV4",
"A6_PV5","A6_PV6",
"A6_PV7","A6_PV8","A6_PV9","A6_PV10")
A6_PC4_Theta_PV[3:12][which(is.na(A6_PC4_Theta_PV[2])),]<-NA
#A7
```

```
A7_PC4_Theta_PV<-as.data.frame(cbind(WLE_A7_PC4$pid,WLE_A7_PC4$theta))
temp<-tam.pv(GPCM_A7_PC4)$pv[2:11]
A7_PC4_Theta_PV<-cbind(A7_PC4_Theta_PV,temp)
names(A7_PC4_Theta_PV)<-c("ID","A7_Theta","A7_PV1","A7_PV2", "A7_PV3" ,"A7_PV4",
"A7_PV5", "A7_PV6",
      "A7_PV7", "A7_PV8", "A7_PV9", "A7_PV10")
A7_PC4_Theta_PV[3:12][which(is.na(A7_PC4_Theta_PV[2])),]<-NA
#A8
A8_PC4_Theta_PV<-as.data.frame(cbind(WLE_A8_PC4$pid,WLE_A8_PC4$theta))
temp<-tam.pv(GPCM_A8_PC4)$pv[2:11]
A8_PC4_Theta_PV<-cbind(A8_PC4_Theta_PV,temp)
names(A8_PC4_Theta_PV)<-c("ID","A8_Theta","A8_PV1","A8_PV2", "A8_PV3" ,"A8_PV4",
"A8_PV5", "A8_PV6",
      "A8_PV7", "A8_PV8", "A8_PV9", "A8_PV10")
A8_PC4_Theta_PV[3:12][which(is.na(A8_PC4_Theta_PV[2])),]<-NA
#A9
A9_PC4_Theta_PV<-as.data.frame(cbind(WLE_A9_PC4$pid,WLE_A9_PC4$theta))
temp<-tam.pv(GPCM_A9_PC4)$pv[2:11]
A9_PC4_Theta_PV<-cbind(A9_PC4_Theta_PV,temp)
names(A9_PC4_Theta_PV)<-c("ID","A9_Theta","A9_PV1","A9_PV2", "A9_PV3" ,"A9_PV4",
"A9_PV5", "A9_PV6",
      "A9_PV7", "A9_PV8", "A9_PV9", "A9_PV10")
A9_PC4_Theta_PV[3:12][which(is.na(A9_PC4_Theta_PV[2])),]<-NA
#A10
A10_PC4_Theta_PV<-as.data.frame(cbind(WLE_A10_PC4$pid,WLE_A10_PC4$theta))
temp<-tam.pv(GPCM_A10_PC4)$pv[2:11]
A10_PC4_Theta_PV<-cbind(A10_PC4_Theta_PV,temp)
names(A10_PC4_Theta_PV)<-c("ID","A10_Theta","A10_PV1","A10_PV2", "A10_PV3" ,"A10_PV4",
"A10_PV5", "A10_PV6",
      "A10_PV7", "A10_PV8", "A10_PV9", "A10_PV10")
A10_PC4_Theta_PV[3:12][which(is.na(A10_PC4_Theta_PV[2])),]<-NA
#A11
A11_PC4_Theta_PV<-as.data.frame(cbind(WLE_A11_PC4$pid,WLE_A11_PC4$theta))
temp<-tam.pv(GPCM_A11_PC4)$pv[2:11]
A11_PC4_Theta_PV<-cbind(A11_PC4_Theta_PV,temp)
names(A11_PC4_Theta_PV)<-c("ID","A11_Theta","A11_PV1","A11_PV2", "A11_PV3" ,"A11_PV4",
"A11_PV5", "A11_PV6",
      "A11_PV7", "A11_PV8", "A11_PV9", "A11_PV10")
A11_PC4_Theta_PV[3:12][which(is.na(A11_PC4_Theta_PV[2])),]<-NA

##Model B
B_PC4_Theta_PV<-as.data.frame(cbind(WLE_B_PC4$pid,WLE_B_PC4$theta))
temp<-tam.pv(GPCM_B_PC4)$pv[2:11]
B_PC4_Theta_PV<-cbind(B_PC4_Theta_PV,temp)
names(B_PC4_Theta_PV)<-c("ID","B_Theta","B_PV1","B_PV2", "B_PV3" ,"B_PV4", "B_PV5",
"B_PV6",
      "B_PV7", "B_PV8", "B_PV9", "B_PV10")

##Model C
C_PC4_Theta_PV<-as.data.frame(cbind(WLE_C_PC4$pid,WLE_C_PC4$theta))
temp<-tam.pv(GPCM_C_PC4)$pv[2:11]
C_PC4_Theta_PV<-cbind(C_PC4_Theta_PV,temp)
names(C_PC4_Theta_PV)<-c("ID","C_Theta","C_PV1","C_PV2", "C_PV3" ,"C_PV4", "C_PV5",
"C_PV6",
      "C_PV7", "C_PV8", "C_PV9", "C_PV10")
```

#D

```
D_WLE<-rowMeans(WLE_D_PC4[25:35],na.rm=T)
temp<-TAM::tam.pv.mcmc(GPCM_D_PC4) ##Warning - this will take a while.
```

#D1 - GR

```
D1_PC4_Theta_PV<-as.data.frame(cbind(WLE_D_PC4$pid,WLE_D_PC4$theta.Dim04))
temp2<-as.data.frame(cbind(temp$pv$PV1.Dim4,temp$pv$PV2.Dim4,
temp$pv$PV3.Dim4,temp$pv$PV4.Dim4,
temp$pv$PV5.Dim4,temp$pv$PV6.Dim4,
temp$pv$PV7.Dim4,temp$pv$PV8.Dim4,
temp$pv$PV9.Dim4,temp$pv$PV10.Dim4
))
temp2[which(is.na(WLE_D_PC4$theta.Dim04)),]<-NA
D1_PC4_Theta_PV<-cbind(D1_PC4_Theta_PV,temp2)
names(D1_PC4_Theta_PV)<-c("ID","D1_Theta","D1_PV1","D1_PV2","D1_PV3","D1_PV4",
"D1_PV5","D1_PV6",
"D1_PV7","D1_PV8","D1_PV9","D1_PV10")
```

#D2 - P

```
D2_PC4_Theta_PV<-as.data.frame(cbind(WLE_D_PC4$pid,WLE_D_PC4$theta.Dim08))
temp2<-as.data.frame(cbind(temp$pv$PV1.Dim8,temp$pv$PV2.Dim8,
temp$pv$PV3.Dim8,temp$pv$PV4.Dim8,
temp$pv$PV5.Dim8,temp$pv$PV6.Dim8,
temp$pv$PV7.Dim8,temp$pv$PV8.Dim8,
temp$pv$PV9.Dim8,temp$pv$PV10.Dim8
))
temp2[which(is.na(WLE_D_PC4$theta.Dim08)),]<-NA
D2_PC4_Theta_PV<-cbind(D2_PC4_Theta_PV,temp2)
names(D2_PC4_Theta_PV)<-c("ID","D2_Theta","D2_PV1","D2_PV2","D2_PV3","D2_PV4",
"D2_PV5","D2_PV6",
"D2_PV7","D2_PV8","D2_PV9","D2_PV10")
```

#D3 -

```
D3_PC4_Theta_PV<-as.data.frame(cbind(WLE_D_PC4$pid,WLE_D_PC4$theta.Dim09))
temp2<-as.data.frame(cbind(temp$pv$PV1.Dim9,temp$pv$PV2.Dim9,
temp$pv$PV3.Dim9,temp$pv$PV4.Dim9,
temp$pv$PV5.Dim9,temp$pv$PV6.Dim9,
temp$pv$PV7.Dim9,temp$pv$PV8.Dim9,
temp$pv$PV9.Dim9,temp$pv$PV10.Dim9
))
temp2[which(is.na(WLE_D_PC4$theta.Dim09)),]<-NA
D3_PC4_Theta_PV<-cbind(D3_PC4_Theta_PV,temp2)
names(D3_PC4_Theta_PV)<-c("ID","D3_Theta","D3_PV1","D3_PV2","D3_PV3","D3_PV4",
"D3_PV5","D3_PV6",
"D3_PV7","D3_PV8","D3_PV9","D3_PV10")
```

#D4 -

```
D4_PC4_Theta_PV<-as.data.frame(cbind(WLE_D_PC4$pid,WLE_D_PC4$theta.Dim02))
temp2<-as.data.frame(cbind(temp$pv$PV1.Dim2,temp$pv$PV2.Dim2,
temp$pv$PV3.Dim2,temp$pv$PV4.Dim2,
temp$pv$PV5.Dim2,temp$pv$PV6.Dim2,
temp$pv$PV7.Dim2,temp$pv$PV8.Dim2,
temp$pv$PV9.Dim2,temp$pv$PV10.Dim2
))
temp2[which(is.na(WLE_D_PC4$theta.Dim02)),]<-NA
```

```
D4_PC4_Theta_PV<-cbind(D4_PC4_Theta_PV,temp2)
names(D4_PC4_Theta_PV)<-c("ID","D4_Theta","D4_PV1","D4_PV2", "D4_PV3", "D4_PV4",
"D4_PV5", "D4_PV6",
"D4_PV7", "D4_PV8", "D4_PV9", "D4_PV10")
```

```
#D5
```

```
D5_PC4_Theta_PV<-as.data.frame(cbind(WLE_D_PC4$pid,WLE_D_PC4$theta.Dim03))
temp2<-as.data.frame(cbind(temp$pv$PV1.Dim3,temp$pv$PV2.Dim3,
temp$pv$PV3.Dim3,temp$pv$PV4.Dim3,
temp$pv$PV5.Dim3,temp$pv$PV6.Dim3,
temp$pv$PV7.Dim3,temp$pv$PV8.Dim3,
temp$pv$PV9.Dim3,temp$pv$PV10.Dim3
```

```
))
```

```
temp2[which(is.na(WLE_D_PC4$theta.Dim03)),]<-NA
D5_PC4_Theta_PV<-cbind(D5_PC4_Theta_PV,temp2)
names(D5_PC4_Theta_PV)<-c("ID","D5_Theta","D5_PV1","D5_PV2", "D5_PV3", "D5_PV4",
"D5_PV5", "D5_PV6",
"D5_PV7", "D5_PV8", "D5_PV9", "D5_PV10")
```

```
#D6
```

```
D6_PC4_Theta_PV<-as.data.frame(cbind(WLE_D_PC4$pid,WLE_D_PC4$theta.Dim10))
temp2<-as.data.frame(cbind(temp$pv$PV1.Dim10,temp$pv$PV2.Dim10,
temp$pv$PV3.Dim10,temp$pv$PV4.Dim10,
temp$pv$PV5.Dim10,temp$pv$PV6.Dim10,
temp$pv$PV7.Dim10,temp$pv$PV8.Dim10,
temp$pv$PV9.Dim10,temp$pv$PV10.Dim10
```

```
))
```

```
temp2[which(is.na(WLE_D_PC4$theta.Dim10)),]<-NA
D6_PC4_Theta_PV<-cbind(D6_PC4_Theta_PV,temp2)
names(D6_PC4_Theta_PV)<-c("ID","D6_Theta","D6_PV1","D6_PV2", "D6_PV3", "D6_PV4",
"D6_PV5", "D6_PV6",
"D6_PV7", "D6_PV8", "D6_PV9", "D6_PV10")
```

```
#D7
```

```
D7_PC4_Theta_PV<-as.data.frame(cbind(WLE_D_PC4$pid,WLE_D_PC4$theta.Dim05))
temp2<-as.data.frame(cbind(temp$pv$PV1.Dim5,temp$pv$PV2.Dim5,
temp$pv$PV3.Dim5,temp$pv$PV4.Dim5,
temp$pv$PV5.Dim5,temp$pv$PV6.Dim5,
temp$pv$PV7.Dim5,temp$pv$PV8.Dim5,
temp$pv$PV9.Dim5,temp$pv$PV10.Dim5
```

```
))
```

```
temp2[which(is.na(WLE_D_PC4$theta.Dim05)),]<-NA
D7_PC4_Theta_PV<-cbind(D7_PC4_Theta_PV,temp2)
names(D7_PC4_Theta_PV)<-c("ID","D7_Theta","D7_PV1","D7_PV2", "D7_PV3", "D7_PV4",
"D7_PV5", "D7_PV6",
"D7_PV7", "D7_PV8", "D7_PV9", "D7_PV10")
```

```
#D8
```

```
D8_PC4_Theta_PV<-as.data.frame(cbind(WLE_D_PC4$pid,WLE_D_PC4$theta.Dim01))
temp2<-as.data.frame(cbind(temp$pv$PV1.Dim1,temp$pv$PV2.Dim1,
temp$pv$PV3.Dim1,temp$pv$PV4.Dim1,
temp$pv$PV5.Dim1,temp$pv$PV6.Dim1,
temp$pv$PV7.Dim1,temp$pv$PV8.Dim1,
temp$pv$PV9.Dim1,temp$pv$PV10.Dim1
```

```
))
```

```
temp2[which(is.na(WLE_D_PC4$theta.Dim01)),]<-NA
```

```

D8_PC4_Theta_PV<-cbind(D8_PC4_Theta_PV,temp2)
names(D8_PC4_Theta_PV)<-c("ID","D8_Theta","D8_PV1","D8_PV2", "D8_PV3", "D8_PV4",
"D8_PV5", "D8_PV6",
"D8_PV7", "D8_PV8", "D8_PV9", "D8_PV10")
#D9
D9_PC4_Theta_PV<-as.data.frame(cbind(WLE_D_PC4$pid,WLE_D_PC4$theta.Dim06))
temp2<-as.data.frame(cbind(temp$pv$PV1.Dim6,temp$pv$PV2.Dim6,
temp$pv$PV3.Dim6,temp$pv$PV4.Dim6,
temp$pv$PV5.Dim6,temp$pv$PV6.Dim6,
temp$pv$PV7.Dim6,temp$pv$PV8.Dim6,
temp$pv$PV9.Dim6,temp$pv$PV10.Dim6
))
temp2[which(is.na(WLE_D_PC4$theta.Dim06)),]<-NA
D9_PC4_Theta_PV<-cbind(D9_PC4_Theta_PV,temp2)
names(D9_PC4_Theta_PV)<-c("ID","D9_Theta","D9_PV1","D9_PV2", "D9_PV3", "D9_PV4",
"D9_PV5", "D9_PV6",
"D9_PV7", "D9_PV8", "D9_PV9", "D9_PV10")
#D10
D10_PC4_Theta_PV<-as.data.frame(cbind(WLE_D_PC4$pid,WLE_D_PC4$theta.Dim07))
temp2<-as.data.frame(cbind(temp$pv$PV1.Dim7,temp$pv$PV2.Dim7,
temp$pv$PV3.Dim7,temp$pv$PV4.Dim7,
temp$pv$PV5.Dim7,temp$pv$PV6.Dim7,
temp$pv$PV7.Dim7,temp$pv$PV8.Dim7,
temp$pv$PV9.Dim7,temp$pv$PV10.Dim7
))
temp2[which(is.na(WLE_D_PC4$theta.Dim07)),]<-NA
D10_PC4_Theta_PV<-cbind(D10_PC4_Theta_PV,temp2)
names(D10_PC4_Theta_PV)<-c("ID","D10_Theta","D10_PV1","D10_PV2", "D10_PV3", "D10_PV4",
"D10_PV5", "D10_PV6",
"D10_PV7", "D10_PV8", "D10_PV9", "D10_PV10")
#D11
D11_PC4_Theta_PV<-as.data.frame(cbind(WLE_D_PC4$pid,WLE_D_PC4$theta.Dim11))
temp2<-as.data.frame(cbind(temp$pv$PV1.Dim11,temp$pv$PV2.Dim11,
temp$pv$PV3.Dim11,temp$pv$PV4.Dim11,
temp$pv$PV5.Dim11,temp$pv$PV6.Dim11,
temp$pv$PV7.Dim11,temp$pv$PV8.Dim11,
temp$pv$PV9.Dim11,temp$pv$PV10.Dim11
))
temp2[which(is.na(WLE_D_PC4$theta.Dim11)),]<-NA
D11_PC4_Theta_PV<-cbind(D11_PC4_Theta_PV,temp2)
names(D11_PC4_Theta_PV)<-c("ID","D11_Theta","D11_PV1","D11_PV2", "D11_PV3", "D11_PV4",
"D11_PV5", "D11_PV6",
"D11_PV7", "D11_PV8", "D11_PV9", "D11_PV10")
D11_PC4_Theta_PV[which(is.na(D11_PC4_Theta_PV$D11_Theta)),3:12]<-NA

temp3<-as.data.frame(cbind(WLE_D_PC4$pid,D_WLE))
names(temp3)<-c("ID","D_WLE_OVERALL_EqWeights")

D_PC4_THETA_PV<-cbind(temp3,
D1_PC4_Theta_PV[2:12],
D2_PC4_Theta_PV[2:12],
D3_PC4_Theta_PV[2:12],
D4_PC4_Theta_PV[2:12],
D5_PC4_Theta_PV[2:12],
D6_PC4_Theta_PV[2:12],
D7_PC4_Theta_PV[2:12],

```

```
D8_PC4_Theta_PV[2:12],
D9_PC4_Theta_PV[2:12],
D10_PC4_Theta_PV[2:12],
D11_PC4_Theta_PV[2:12])
```

```
A_PC4_THETA_PV<-cbind(A1_PC4_Theta_PV[1:12],
  A2_PC4_Theta_PV[2:12],
  A3_PC4_Theta_PV[2:12],
  A4_PC4_Theta_PV[2:12],
  A5_PC4_Theta_PV[2:12],
  A6_PC4_Theta_PV[2:12],
  A7_PC4_Theta_PV[2:12],
  A8_PC4_Theta_PV[2:12],
  A9_PC4_Theta_PV[2:12],
  A10_PC4_Theta_PV[2:12],
  A11_PC4_Theta_PV[2:12])
```

```
PC4_THETA<-merge(A_PC4_THETA_PV,B_PC4_Theta_PV,idvar="ID")
PC4_THETA<-merge(PC4_THETA,C_PC4_Theta_PV,idvar="ID")
PC4_THETA<-merge(PC4_THETA,D_PC4_THETA_PV,idvar="ID")
```

```
names(PC4_THETA)
```

```
###Create PV matrix for overall ds.
```

```
PV_D_Overall<-as.data.frame(rep(NA,nrow(d4)))
```

```
PV_D_Overall[1]<-rowMeans(cbind(
```

```
  PC4_THETA$D1_PV1,
  PC4_THETA$D2_PV1,
  PC4_THETA$D3_PV1,
  PC4_THETA$D4_PV1,
  PC4_THETA$D5_PV1,
  PC4_THETA$D6_PV1,
  PC4_THETA$D7_PV1,
  PC4_THETA$D8_PV1,
  PC4_THETA$D9_PV1,
  PC4_THETA$D10_PV1),na.rm=T)
```

```
PV_D_Overall[2]<-rowMeans(cbind(
```

```
  PC4_THETA$D1_PV2,
  PC4_THETA$D2_PV2,
  PC4_THETA$D3_PV2,
  PC4_THETA$D4_PV2,
  PC4_THETA$D5_PV2,
  PC4_THETA$D6_PV2,
  PC4_THETA$D7_PV2,
  PC4_THETA$D8_PV2,
  PC4_THETA$D9_PV2,
  PC4_THETA$D10_PV2),na.rm=T)
```

```
PV_D_Overall[3]<-rowMeans(cbind(
```

```
  PC4_THETA$D1_PV3,
  PC4_THETA$D2_PV3,
  PC4_THETA$D3_PV3,
  PC4_THETA$D4_PV3,
  PC4_THETA$D5_PV3,
  PC4_THETA$D6_PV3,
  PC4_THETA$D7_PV3,
  PC4_THETA$D8_PV3,
```

```
PC4_THETA$D9_PV3,
PC4_THETA$D10_PV3),na.rm=T)
PV_D_Overall[4]<-rowMeans(cbind(
PC4_THETA$D1_PV4,
PC4_THETA$D2_PV4,
PC4_THETA$D3_PV4,
PC4_THETA$D4_PV4,
PC4_THETA$D5_PV4,
PC4_THETA$D6_PV4,
PC4_THETA$D7_PV4,
PC4_THETA$D8_PV4,
PC4_THETA$D9_PV4,
PC4_THETA$D10_PV4),na.rm=T)
PV_D_Overall[5]<-rowMeans(cbind(
PC4_THETA$D1_PV5,
PC4_THETA$D2_PV5,
PC4_THETA$D3_PV5,
PC4_THETA$D4_PV5,
PC4_THETA$D5_PV5,
PC4_THETA$D6_PV5,
PC4_THETA$D7_PV5,
PC4_THETA$D8_PV5,
PC4_THETA$D9_PV5,
PC4_THETA$D10_PV5),na.rm=T)
PV_D_Overall[6]<-rowMeans(cbind(
PC4_THETA$D1_PV6,
PC4_THETA$D2_PV6,
PC4_THETA$D3_PV6,
PC4_THETA$D4_PV6,
PC4_THETA$D5_PV6,
PC4_THETA$D6_PV6,
PC4_THETA$D7_PV6,
PC4_THETA$D8_PV6,
PC4_THETA$D9_PV6,
PC4_THETA$D10_PV6),na.rm=T)
PV_D_Overall[7]<-rowMeans(cbind(
PC4_THETA$D1_PV7,
PC4_THETA$D2_PV7,
PC4_THETA$D3_PV7,
PC4_THETA$D4_PV7,
PC4_THETA$D5_PV7,
PC4_THETA$D6_PV7,
PC4_THETA$D7_PV7,
PC4_THETA$D8_PV7,
PC4_THETA$D9_PV7,
PC4_THETA$D10_PV7),na.rm=T)
PV_D_Overall[8]<-rowMeans(cbind(
PC4_THETA$D1_PV8,
PC4_THETA$D2_PV8,
PC4_THETA$D3_PV8,
PC4_THETA$D4_PV8,
PC4_THETA$D5_PV8,
PC4_THETA$D6_PV8,
PC4_THETA$D7_PV8,
PC4_THETA$D8_PV8,
PC4_THETA$D9_PV8,
PC4_THETA$D10_PV8),na.rm=T)
```

```
PV_D_Overall[9]<-rowMeans(cbind(
  PC4_THETA$D1_PV9,
  PC4_THETA$D2_PV9,
  PC4_THETA$D3_PV9,
  PC4_THETA$D4_PV9,
  PC4_THETA$D5_PV9,
  PC4_THETA$D6_PV9,
  PC4_THETA$D7_PV9,
  PC4_THETA$D8_PV9,
  PC4_THETA$D9_PV9,
  PC4_THETA$D10_PV9),na.rm=T)
PV_D_Overall[10]<-rowMeans(cbind(
  PC4_THETA$D1_PV10,
  PC4_THETA$D2_PV10,
  PC4_THETA$D3_PV10,
  PC4_THETA$D4_PV10,
  PC4_THETA$D5_PV10,
  PC4_THETA$D6_PV10,
  PC4_THETA$D7_PV10,
  PC4_THETA$D8_PV10,
  PC4_THETA$D9_PV10,
  PC4_THETA$D10_PV10),na.rm=T)

names(PV_D_Overall)<-c("D_Overall_PV1","D_Overall_PV2","D_Overall_PV3","D_Overall_PV4",
  "D_Overall_PV5","D_Overall_PV6","D_Overall_PV7","D_Overall_PV8",
  "D_Overall_PV9","D_Overall_PV10")

PC4_THETA<-cbind(PC4_THETA,PV_D_Overall)

names(PC4_THETA)

##Export
write.csv(PC4_THETA, "PC4_Theta_and_PVs.csv")
```

8.2.4. Script for DIF Analyses

```

##NOTE this is an example of DIF analyses for variable "SEX."
##Other variables follow the same script but with the variable switched

##FullyAdvanced Dif#
##Libraries####
library(TAM)
library(sirt)
library(dplyr)
##Backbone & Base####
tam_ctrl <- list(nodes = seq(-6, 6, len = 21),
                snodes = 0, QMC = TRUE,
                Msteps = 4,
                increment.factor = 1, fac.oldxsi = 0, acceleration = "none")
tam_ctrl$increment.factor <- 1.05
this_tam_ctrl<-tam_ctrl
this_tam_ctrl$fac.oldxsi <- .0
this_tam_ctrl$Msteps<-5
this_tam_ctrl$increment.factor = 1.10
this_tam_ctrl$acceleration = "Ramsay"

beta.fixed <- rbind(cbind(1,1,0), cbind(2,1,0))
# needed here s.t. location dif fully on item parameter side
variance.fixed <- as.matrix(data.frame( # multigroup variance fixation only in tam.mml.3pl
  "group" = 1:2, # needed here s.t. discrim dif fully on item parameter side
  "dim1" = 1,
  "dim2" = 1,
  "value" = 1
))

#Define Q Matrix
Q <- matrix(0, nrow = length(items_PC4), ncol = length(unique(constructs_PC4)),
            dimnames = list(items_PC4, sort(unique(constructs_PC4))))
Q[cbind(1:length(items_PC4), match(constructs_PC4, colnames(Q)))] <- 1

##Recreate model B in a loop for ease of calculation##
md_list <- setNames(vector(mode= "list",11), c(
  "GR","P","TG","EF","G","TR","HF","D","I","L","V"))

for(dd in names(md_list)){
  md_list[[dd]] <- list("mod" = tam.mml.2pl(d4[, names(which(Q[, dd] == 1))],
    pid = pid,
    irtmodel = "GPCM",
    control = this_tam_ctrl))
  md_list[[dd]] <- c(md_list[[dd]], list("wle" = tam.mml.wle(md_list[[dd]]$mod)))
}

###SEX####
lrts_SEX<-setNames(vector(mode="list",11), c(
  "GR","P","TG","EF","G","TR","HF","D","I","L","V"))

###Fully Advanced###
for(j in names(md_list)) { #Repeat for each B model
# for(j in 1:1) { #Test condition for just GR

```

```

md <- md_list[[j]]$mod
facets <- d0_Trimmed[match(md$pid, d0_Trimmed$ID), "SEX", drop = FALSE] # make sure facets is
a data frame
ind <- which(!is.na(facets$SEX) & (!facets$SEX %in% c(3, -77))) &
      rowSums(!is.na(md$resp)) > 0) # drop NA
resp_orig <- md$resp[ind, ] # will be used later
pid_orig <- md$pid[ind] # will be used later
facets <- facets[ind,,drop = FALSE] # make sure facets is a data frame
table(facets)

base <- tam.mml.3pl(resp_orig,
  pid = pid_orig,
  group = facets$SEX,
  beta.fixed = beta.fixed,
  variance.fixed = variance.fixed,
  control = this_tam_ctrl)
difDes <- tam.mml.mfr(resp_orig,
  formulaA = ~item + item:step + SEX,
  facets = facets,
  control = list(maxiter = 1), verbose = FALSE)
# we just need the extended response matrix and the design matrix
lrts <- setNames(vector(length = ncol(resp_orig), mode = "list"), colnames(resp_orig))
for(ii in names(lrts)){
  iiDesign <- paste0(ii, "-SEX", 1:2)
  iiCatvar <- grep(paste0(ii, "_Cat"), dimnames(md$A)[[3]], value = TRUE)
  ind <- match(ii, names(lrts))

  resp <- cbind(difDes$resp[, iiDesign], resp_orig[, -ind])

  A <- array(0, dim = dim(base$A) + c(1, 0, 1))
  # Add SEX from DIF-Parameter
  dimnames(A) <- list(colnames(resp),
    dimnames(base$A)[[2]],
    c(dimnames(base$A)[[3]], "SEX"))
  A[iiDesign, , iiCatvar] <- base$A[rep(ind, 2), , iiCatvar] # new item loadings
  A[setdiff(dimnames(A)[[1]], iiDesign),,
    setdiff(dimnames(A)[[3]], "SEX")] <- md$A[-ind,,] # every other loading stays the same
  A[iiDesign, , "SEX"] <- difDes$A[iiDesign,, "SEX1"] # new SEX from DIF loadings

  non_unif <- tam.mml.3pl(resp,
    pid = pid_orig,
    group = facets$SEX,
    A = A, # new loading structure
    beta.fixed = beta.fixed,
    variance.fixed = variance.fixed,
    control = this_tam_ctrl)

  gammaslope.constr.V <- matrix(0, nrow = length(non_unif$gammaslope), ncol = 1)
  gammaslope.constr.V[1:2, 1] <- c(1, -1) # common loading for DIF item
  gammaslope.constr.c <- 0

  unif <- tam.mml.3pl(resp,
    pid = pid_orig,
    group = facets$SEX,
    A = A, # new loading structure
    beta.fixed = beta.fixed,

```

```
variance.fixed = variance.fixed,  
gammaslope.constr.V = gammaslope.constr.V,  
gammaslope.constr.c = gammaslope.constr.c,  
control = this_tam_ctrl)
```

```
#  
  lrts[[ind]] <- list(anova(base, non_unif), anova(unif, non_unif), anova(base, unif))  
}  
lrts_SEX[[j]] <- lrts  
}
```

8.2.5. Script for True Score Equating

```

##This extracts the function for the individual theta values, in the same way
##Problem IDs must be extracted and isolated from each subscale in Model D.
##This will create a test characteristic function for participant ability for each subscale.
##This works because each problem loads only onto the subscale it belongs to.
##also see the documentation for the function truescore.irt in the package "sirt."

##ensure we are using Q matrix from PCS4:
Q <- matrix(0, nrow = length(items_PC4), ncol = length(unique(constructs_PC4)),
            dimnames = list(items_PC4, sort(unique(constructs_PC4))))
Q[cbind(1:length(items_PC4), match(constructs_PC4, colnames(Q)))] <- 1

##D1_GR
(colnames(Q)) ## ##Identify Matrix number based on Q Matrix
dd_ind<-4 ##Index based on the Q Matrix - This selects the correct subscale
tmp1 <- GPCM_D_PC4 #Create temporary variable as a copy of Model D
tmp1$B <- tmp1$B[,dd_ind, drop = FALSE] #Select for problems in the index
dd_items_ind <- which(Q[, dd_ind] == 1) #Create item list to double check items were correctly chosen
dd_items_ind #Verify item numbers
##Grab rows only for ones included in the subscale
##pull parameters - see comments on function truescore.irt in package "sirt"
A<-tmp1$B[min(dd_items_ind):max(dd_items_ind),-1,1]
B<-tmp1$AXsi[min(dd_items_ind):max(dd_items_ind),-1]
x<-sirt::truescore.irt(A=A,B=B,theta=seq(-5,5,leng=1000),pid=seq(-5,5,leng=1000)) #create temp var
for export
write.csv(x,"TS_D1.csv") #export

##D2_P
(colnames(Q)) ## ##Identify Matrix number based on Q Matrix
dd_ind<-8 ##Index based on the Q Matrix
tmp1 <- GPCM_D_PC4
tmp1$B <- tmp1$B[,dd_ind, drop = FALSE]
dd_items_ind <- which(Q[, dd_ind] == 1)
dd_items_ind #Verify item numbers
##Grab rows only for ones included in the subscale
##pull parameters
A<-tmp1$B[min(dd_items_ind):max(dd_items_ind),-1,1]
B<-tmp1$AXsi[min(dd_items_ind):max(dd_items_ind),-1]
x<-sirt::truescore.irt(A=A,B=B,theta=seq(-5,5,leng=1000),pid=seq(-5,5,leng=1000)) #create temp var
for export
write.csv(x,"TS_D2.csv")

##D3_TG
(colnames(Q)) ## ##Identify Matrix number based on Q Matrix
dd_ind<-9 ##Index based on the Q Matrix
tmp1 <- GPCM_D_PC4
tmp1$B <- tmp1$B[,dd_ind, drop = FALSE]
dd_items_ind <- which(Q[, dd_ind] == 1)
dd_items_ind #Verify item numbers
##Grab rows only for ones included in the subscale
##pull parameters
A<-tmp1$B[min(dd_items_ind):max(dd_items_ind),-1,1]
B<-tmp1$AXsi[min(dd_items_ind):max(dd_items_ind),-1]
x<-sirt::truescore.irt(A=A,B=B,theta=seq(-5,5,leng=1000),pid=seq(-5,5,leng=1000))
write.csv(x,"TS_D3.csv")

```

##D4_EF

```
(colnames(Q)) ## ##Identify Matrix number based on Q Matrix
dd_ind<-2 ##Index based on the Q Matrix
tmp1 <- GPCM_D_PC4
tmp1$B <- tmp1$B[,dd_ind, drop = FALSE]
dd_items_ind <- which(Q[, dd_ind] == 1)
dd_items_ind #Verify item numbers
##Grab rows only for ones included in the subscale
##pull parameters
A<-tmp1$B[min(dd_items_ind):max(dd_items_ind),-1,1]
B<-tmp1$AXsi[min(dd_items_ind):max(dd_items_ind),-1]
x<-sirt::truescore.irt(A=A,B=B,theta=seq(-5,5,leng=1000),pid=seq(-5,5,leng=1000))
write.csv(x,"TS_D4.csv")
```

##D5_G

```
(colnames(Q)) ## ##Identify Matrix number based on Q Matrix
dd_ind<-3 ##Index based on the Q Matrix
tmp1 <- GPCM_D_PC4
tmp1$B <- tmp1$B[,dd_ind, drop = FALSE]
dd_items_ind <- which(Q[, dd_ind] == 1)
dd_items_ind #Verify item numbers
##Grab rows only for ones included in the subscale
##pull parameters
A<-tmp1$B[min(dd_items_ind):max(dd_items_ind),-1,1]
B<-tmp1$AXsi[min(dd_items_ind):max(dd_items_ind),-1]
x<-sirt::truescore.irt(A=A,B=B,theta=seq(-5,5,leng=1000),pid=seq(-5,5,leng=1000))
write.csv(x,"TS_D5.csv")
```

##D6_TR

```
(colnames(Q)) ## ##Identify Matrix number based on Q Matrix
dd_ind<-10 ##Index based on the Q Matrix
tmp1 <- GPCM_D_PC4
tmp1$B <- tmp1$B[,dd_ind, drop = FALSE]
dd_items_ind <- which(Q[, dd_ind] == 1)
dd_items_ind #Verify item numbers
##Grab rows only for ones included in the subscale
##pull parameters
A<-tmp1$B[min(dd_items_ind):max(dd_items_ind),-1,1]
B<-tmp1$AXsi[min(dd_items_ind):max(dd_items_ind),-1]
x<-sirt::truescore.irt(A=A,B=B,theta=seq(-5,5,leng=1000),pid=seq(-5,5,leng=1000))
write.csv(x,"TS_D6.csv")
```

##D7_HF

```
(colnames(Q)) ## ##Identify Matrix number based on Q Matrix
dd_ind<-5 ##Index based on the Q Matrix
tmp1 <- GPCM_D_PC4
tmp1$B <- tmp1$B[,dd_ind, drop = FALSE]
dd_items_ind <- which(Q[, dd_ind] == 1)
dd_items_ind #Verify item numbers
##Grab rows only for ones included in the subscale
##pull parameters
A<-tmp1$B[min(dd_items_ind):max(dd_items_ind),-1,1]
B<-tmp1$AXsi[min(dd_items_ind):max(dd_items_ind),-1]
x<-sirt::truescore.irt(A=A,B=B,theta=seq(-5,5,leng=1000),pid=seq(-5,5,leng=1000))
write.csv(x,"TS_D7.csv")
```

```
##D8_D
(colnames(Q)) ## ##Identify Matrix number based on Q Matrix
dd_ind<-1 ##Index based on the Q Matrix
tmp1 <- GPCM_D_PC4
tmp1$B <- tmp1$B[,dd_ind, drop = FALSE]
dd_items_ind <- which(Q[, dd_ind] == 1)
dd_items_ind #Verify item numbers
##Grab rows only for ones included in the subscale
##pull parameters
A<-tmp1$B[min(dd_items_ind):max(dd_items_ind),-1,1]
B<-tmp1$AXsi[min(dd_items_ind):max(dd_items_ind),-1]
x<-sirt::truescore.irt(A=A,B=B,theta=seq(-5,5,leng=1000),pid=seq(-5,5,leng=1000))
write.csv(x,"TS_D8.csv")
```

```
##D9_I
(colnames(Q)) ## ##Identify Matrix number based on Q Matrix
dd_ind<-6 ##Index based on the Q Matrix
tmp1 <- GPCM_D_PC4
tmp1$B <- tmp1$B[,dd_ind, drop = FALSE]
dd_items_ind <- which(Q[, dd_ind] == 1)
dd_items_ind #Verify item numbers
##Grab rows only for ones included in the subscale
##pull parameters
A<-tmp1$B[min(dd_items_ind):max(dd_items_ind),-1,1]
B<-tmp1$AXsi[min(dd_items_ind):max(dd_items_ind),-1]
x<-sirt::truescore.irt(A=A,B=B,theta=seq(-5,5,leng=1000),pid=seq(-5,5,leng=1000))
write.csv(x,"TS_D9.csv")
```

```
##D10_L
(colnames(Q)) ## ##Identify Matrix number based on Q Matrix
dd_ind<-7 ##Index based on the Q Matrix
tmp1 <- GPCM_D_PC4
tmp1$B <- tmp1$B[,dd_ind, drop = FALSE]
dd_items_ind <- which(Q[, dd_ind] == 1)
dd_items_ind #Verify item numbers
##Grab rows only for ones included in the subscale
##pull parameters
A<-tmp1$B[min(dd_items_ind):max(dd_items_ind),-1,1]
B<-tmp1$AXsi[min(dd_items_ind):max(dd_items_ind),-1]
x<-sirt::truescore.irt(A=A,B=B,theta=seq(-5,5,leng=1000),pid=seq(-5,5,leng=1000))
write.csv(x,"TS_D10.csv")
```

```
##D11_V
(colnames(Q)) ## ##Identify Matrix number based on Q Matrix
dd_ind<-11 ##Index based on the Q Matrix
tmp1 <- GPCM_D_PC4
tmp1$B <- tmp1$B[,dd_ind, drop = FALSE]
dd_items_ind <- which(Q[, dd_ind] == 1)
dd_items_ind #Verify item numbers
##Grab rows only for ones included in the subscale
##pull parameters
A<-tmp1$B[min(dd_items_ind):max(dd_items_ind),-1,1]
B<-tmp1$AXsi[min(dd_items_ind):max(dd_items_ind),-1]
x<-sirt::truescore.irt(A=A,B=B,theta=seq(-5,5,leng=1000),pid=seq(-5,5,leng=1000))
write.csv(x,"TS_D11.csv")
```