

Genetic distances and phylogeography of selected disjunct moss populations in Europe

Dissertation

zur

Erlangung des Doktorgrades (Dr. rer. nat.)

der

Mathematisch-Naturwissenschaftlichen Fakultät

der

Rheinischen-Friedrich-Wilhelms-Universität Bonn

vorgelegt von
Marko Sabovljević
aus
Belgrad

Bonn 2006

Angefertigt mit Genehmigung der Mathematisch – Naturwissenschaftlichen Fakultät der Rheinischen-Friedrich-Wilhelms-Universität Bonn

1. Referent: Prof. Dr. J.-P. Frahm
2. Referent: PD. Dr. W. Barthlott
3. Referent: Prof. Dr. T. Litt
4. Referent: PD. Dr. J. Löffler

Tag der Promotion: Juli 2005

Diese Dissertation ist auf dem Hochschulschriftenserver der ULB Bonn http://hss.ulb.uni-bonn.de/diss_online elektronisch publiziert

to my parents,
meinen Eltern,
mojim roditeljima,

to my Aneta,
meiner Aneta,
mojoj Aneti

and to my friends.
und meinen Freunden.
i mojim prijateljima.

1.0. INTRODUCTION	1
1.1. Bryophyte relictness vs. Bryophyte dispersal	1
1.1.1. Bryophyte dispersal	1
1.1.2. Bryophyte relicts	3
1.1.3. About glaciations	5
1.2. Effects of glaciations on biotas	8
1.2.1. Selection for vagility	12
1.2.2. Selection for the low specialization	13
1.2.3. Interbreeding during range advances	14
1.3. Molecular tracing of population relationships and past migration events: insights from the nuclear ribosomal DNA: Internal Transcribed Spacer (ITS) and plastid non-coding DNA region (<i>trnL</i> -F spacer and intron)	16
1.3.1. Plant DNA sequence markers suitable for phylogeographic studies	20
1.3.2. Internal Transcribed Spacer of the nrDNA	23
1.3.3. <i>trnL-trnF</i> region of the plastid DNA	29
1.4. Bryophyte phylogeography	30
1.5. Species chosen for our investigations	34
1.5.1. <i>Campylopus oerstedianus</i>	35
1.5.2. <i>Hilpertia velenovskyi</i>	38
1.5.3. <i>Isothecium holtii</i>	39
1.5.4. <i>Rhytidium rugosum</i>	40
1.5.5. <i>Dichelyma capillaceum</i>	41
2.0. AIMS, MATERIAL AND METHODS	44
2.1. Aims	44
2.2. Material preparation	45
2.3. DNA extraction	46
2.4. Polymerase Chain Reaction protocols	48
2.5. Primers	49
2.6. Agarose gels	51
2.7. Stock solutions and buffers	52
2.8. Alignment	56
2.9. Cladistic analysis	56
2.9.1. Maximum Parsimony (MP)	56
2.9.2. Maximum Likelihood (ML)	58
2.9.3. Neighbor Joining (NJ)	58
2.9.4. Bootstrap Analysis	59
2.9.5. The chose of the outgroup	59
3.0. RESULTS	60
3.1. Relict or long-distance dispersal? A phylogeography case study of the rare and endangered moss <i>Campylopus oerstedianus</i> (Müll. Hall.) Mitt. (Dicranaceae) in Europe	61
3.2. The origin of the German populations of <i>Hilpertia velenovskyi</i> (Pottiaceae, Bryopsida): inferences from variation in the nuclear ITS region	73
3.3. Taxonomic value, systematic position and the origin of German populations of <i>Isothecium holtii</i> Kindb. based on molecular data	83
3.4. Genetic diversity and phylogeography of the moss <i>Rhytidium rugosum</i> (Hedw.) Kindb. (Hypnales) in Europe	94
3.5. The origin of German population of <i>Dichelyma capillaceum</i> inferred by <i>trnL</i> -F plastid DNA sequences	109
4.0. DISCUSSION	118
5.0. CONCLUSIONS	128
6.0. SUMMARY	129
7.0. ACKNOWLEDGEMENTS	133
8.0. REFERENCES	134

1.0. INTRODUCTION

1.1 BRYOPHYTE RELICTNESS VS. BRYOPHYTE DISPERSAL

1.1.1. Bryophyte dispersal

In recent years the dispersal ecology of vascular plants (Bonn and Poschlod, 1998) and bryophytes (Muñoz *et al.*, 2004) has received much attention. The interest has occurred as a result of the wide recognition that diaspore dispersal plays a significant role in the maintenance of plant populations and colonization of newly created habitats, and with the recognition of unexplained genetic differences among species with rare sexual reproduction.

In bryophytes which produce spores, they are often produced in large numbers and dispersed over long distances by wind (e. g. Miles and Longton, 1992; Stoneburner *et al.*, 1992; Marchall and Convey, 1997). However, some dioecious species rarely or never produce sporophytes over large areas or not at all (Longton and Miles, 1982; Longton and Schuster, 1983). For these species dispersal by vegetative means such as specialized propagules and unspecialised gametophyte fragments, may be an important or even the only mode of dispersal. It is generally accepted that these vegetative bryophyte diaspores generally achieve much shorter dispersal distances by wind than do spores, due to their larger size (e. g. Longton and Schuster, 1983; Kimmerer, 1991). Since most of the bryophyte propagules do not show spezialization

for dispersal, most of the authors consider that they are transported by wind, storms, water flows, animals or other unidentified means passively (Muñoz *et al.*, 2004). However, the distances and vectors remain obscured for many propagule types and many species. One of rarely exploited theory of bryophyte propagules is epizoochory. Some authors give very low importance to this theory, since bryophytes have no special means of ensuring attachment (van Zanten and Pócs, 1981). With the exception the extended study of flies dispersing the spores of splachnaceous mosses (Marino, 1991), there have been only few reports of epizoochorous dispersal of mosses (Sarafis, 1971; van Zanten and Pócs, 1981; Lloret, 1994; Lewis Smith, 1999; Hainken, 2000; Heinken *et al.*, 2001; Ignatov and Ignatova, 2001). However, long distance dispersal of bryophytes is still the subject of unclearness and many possibility remain since lately evidence of passive long distance dispersal are proven even for organisms such as snails or some other organisms not adapted for passive transport (e. g. Uit de Weerd *et al.* 2005). Heinken *et al.* (2001) state that slender pleurocarpous moss species are commonly found on large mammals and that dispersal of bryophytes this way may not be restricted to short distances. There is no any evidence of other animal vector so far like fishes, insects, snails, etc. There are some considerations of birds as dispersal factor while collecting bryophytes for nests (Sernander, 1901; Heintze, 1915; Breil and Moyle, 1976; Davison, 1976), but not while birds migrations or range expansions. The transported fragments can function as diaspores, epizoochorous transport of unspecialised gametophyte fragments may play a significant, but so far under-estimated role in dispersal of bryophyte species, especially those without asexual propagules and with rare sexual reproduction.

In most studies considering bryophyte dispersal, there are a lot of assumptions without true evidence of spreading (e.g. Schofield, 1985). Spreading vectors are not easy to recognize or to measure the distance of spore and diaspore dispersal, as well as habitats suitable for new population establishing. However, sporadically there is an apparent evidence of rapid long distance dispersal in bryophytes (e.g. Young and Kläy, 1971).

1.1.2. Bryophyte relicts

Relict plant is a recent but old species that remains from some previous floras. The age of species are hard to estimate but data can be obtained from various fossil records, habitats they invade, ecology and present geography, etc. There are many fossil records for vascular plant species which are considered as relict due to its morphology. For bryophytes, the direct confirmation of relictness is rather rare and so less knowledge is present on bryophyte relicts.

Relicts can be categorized by the epoch which they derive from (xerotherm relict, glacial relict...) or by the size of range they have at present (endemo-relict or relict of wide range). There are very few concrete considerations on relict species among bryophytes, although it is widely accepted that the group is ancient.

Only few studies dealing with various aspects of bryophyte relicts (eg. Steere, 1937; Heusser, 1972; Lazarenko, 1974; Obgaard, 1988; Blanár and Šoltés, 2000; Dítě and Šoltés, 2002).

In general, it is accepted that most of the relict species survived Ice Age in the Southern European refuges, although lately there are many new proofs that different organisms survived in central even northern Europe in so called small refuges or cryptorefuges (eg. Torroni *et al.*, 2001; Müller *et al.*, 2003; Hubberten *et al.*, 2004). The first evidence for xerotherm relict survived in Middle Europe for bryophyte *Anacolia laevisphaera* are provided by Quandt *et al.* (2000), at first erroneously reported as *Bartramia stricta*, although classical approach suggest that all potential bryophyte relicts survived in the southern Europe (Herzog, 1926; Gams, 1932; Schuster, 1984).

Based on the range sciences and in general of present distribution of bryophytes, most of bryologists considered some bryophyte to be of relict origin. The most comprehensive views of relicts among bryophytes (Tab. 1) can be found in Frahm (2001). There are three groups of bryophyte relicts: glacial (arctic-alpine and boreal

species survived in postglacial period in non boreal habitats), xerothermrelicts (mostly Mediterranean species survived postglacial warm period (6000-7800 years B. P.) in temperate habitats) and tertiary relicts (tropical species mild climate mostly Atlantic Europe).

Tab. 1. The list of European bryophyte relicts accepted by most of the authors (according to Frahm, 2001; changed)

European bryophyte relicts		
Glacial	Xerotherm	Tertiar
<i>Caliergon richardsonii</i>	<i>Bartramia stricta</i>	<i>Adelanthus decipiens</i>
<i>Caliergon trifarium</i>	<i>Bryum torquescens</i>	<i>A. lindenbergianus</i>
<i>Catoscopium nigratum</i>	<i>Campylopus oerstedianus</i>	<i>Braunia alopecura</i>
<i>Chandonanthus setiformis</i>	<i>Fabronia ciliaris</i>	<i>Calypers erosum</i>
<i>Cinclidium stygium</i>	<i>Funaria muehlenbergii</i>	<i>Campylopus shawii</i>
<i>Helodium blandowii</i>	<i>Mannia fragrans</i>	<i>C. flexuosus</i>
<i>Hilpertia velenovskyi</i>	<i>Pleurochaete squarrosa</i>	<i>Colura calyptrifolia</i>
<i>Hymenostylium recurvirostre</i>	<i>Pottia recta</i>	<i>Cynclodictyon laetevirens</i>
<i>Meesia triquetra</i>	<i>Pottia starkeana</i>	<i>Drepanolejeunea hamatifolia</i>
<i>Mnium cinclidioides</i>	<i>Pterygoneurum cavifolium</i>	<i>Harpalejeunea molleri</i>
<i>Paludella squarrosa</i>	<i>P. lamellatum</i>	<i>Isothecium holtii</i>
<i>Rhytidium rugosum</i>	<i>P. subsessile</i>	<i>Jubula hutchinsiae</i>
<i>Scorpidium turgescens</i>	<i>Rhynchostegiella tenella</i>	<i>Lepidozia cupresina</i>
<i>Sphagnum lindbergii</i>	<i>Scleropodium illecebrum</i>	<i>Leptoscyphus cuneifolius</i>
<i>Tetraplodon angustatus</i>	<i>Sphero carpus texanus</i>	<i>Marchesinia mackii</i>
	<i>Targionia hypophylla</i>	<i>Neckera intermedia</i>
	<i>Tortella nitida</i>	<i>Plagiochila killarniensis</i>
	<i>Tortula atrovirens</i>	<i>Teleranea nematodes</i>
	<i>T. canescens</i>	<i>Tetrastichium virens</i>
	<i>T. inermis</i>	<i>Trematodon longicollis</i>
	<i>T. princeps</i>	
	<i>Trichostomum brachydontium</i>	
	<i>Weissia crispata</i>	
	<i>W. tortilis</i>	

When considering relict and rarness of the relict species, as well as genetic differences among them, “Nunatak” theory should always be in mind. It means that

small populations of relict organism survived Ice Age in small isolated places with somewhat more pleasant microclimate and spread or not from that places afterwards, when conditions permit (e.g. Fernald, 1925; Belland *et al.*, 1992). The opponent theory is long distance dispersal (e.g. Bouchard *et al.*, 1977). Lately, there are overlapping results between two, and it seems to be that both hypothesis have confirmation (e. g. Brouillet *et al.*, 1998).

1.1.3. About glaciations

Various types of paleoclimatic evidences suggest that the climate of the Earth has varied over time. The data suggests that during most of the Earth's history, global temperatures were probably 8 to 15° Celsius warmer than they are today (Raymo, 1994). However, there were periods of times when the Earth's average global temperature became cold. It was cold enough for the formation of alpine glaciers and continental glaciers that extended into the higher, middle and sometimes lower latitudes. In the last billion years of Earth history, glacial periods have started at roughly 925, 800, 680, 450, 330, and 2 million years before present (B.P.). Of these ice ages, the most severe occurred at 800 million years ago when glaciers came within 5 degrees of the equator.

The last major glacial period began about 2,000,000 years B.P. and is commonly known as the Pleistocene or Ice Age. During this glacial period, large glacial ice sheets covered much of the North America, Europe, and Asia for long periods of time (Benn and Evans, 1998). The extent of the glacier ice during the Pleistocene, however, was not static. The Pleistocene had periods when the glaciers retreated (interglacial) because of mild temperatures, and advanced because of colder temperatures (glacial). Average global temperatures were probably 4 to 5° Celsius colder than they are today at the peak of the Pleistocene. The most recent glacial retreat began about 15,000 years B.P. and is still going on (Jansen and Sjöholm, 1991). We call this period the Holocene epoch.

Today, glacial ice covers about 10 % of the Earth's land surface. During the height of the Pleistocene, ice sheets probably covered about 30 %. Currently, the most extensive continental glaciers are found in Antarctica and Greenland. We can also find smaller glaciers at higher elevations in various mountain ranges in the lower, middle, and higher latitudes.

Glaciers can be classified according to size. Continental glaciers are the largest, with surface coverage in the order of 5 million square kilometers. Antarctica is a good example of a continental glacier. Mountain or alpine glaciers are the smallest type of glacier. These glaciers can range in size from a small mass of ice occupying a cirque to a much larger system filling a mountain valley. Some mountain glaciers are even found in the tropics. The merger of many alpine glaciers creates the third type of glacier, piedmont glaciers. Piedmont glaciers are between several thousand to several tens of thousands of square kilometers in size.

In North America, the Pleistocene glaciers began their formation in the higher altitudes of the Rocky Mountains, and high latitude locations in Greenland and north-central Canada. From these locations, the ice spread in all directions following the topography of the landscape. In North America, the glaciers from the Rocky Mountains and north-central Canada met each other in the center of the continent creating an ice sheet that stretched from the Pacific to the Atlantic Ocean. At their greatest extent, the ice sheets of North America covered most of Canada and extended into the United States to latitude of about 40° North. Shortly, the range of glaciers during the peak of the last Ice Age (ca. 15000 years B. P.) comprised continuously Northern America, and the ice glaciers made contact coming from the western and eastern mountain ranges in central plateau.

A similar pattern of glaciation has also been scientifically documented in Europe (Fig. 1) and Asia. In Eurasia, ice sheets had their birth place in the Alps Mountains,

Scandinavia, northern British Isles, and northern Siberia. The ice sheets of Eurasia, however, did not form a single ice sheet through convergence and their furthest extent south was limited to a latitude of about 45° North. In Europe, the distribution was more complicated. Ice cap comprised British Isles, almost all Fenno-Scandia, Northern Germany, Northern Poland, Baltic Countries and northern European Russia, while by the newest data Severnaya Zemlya, and the Eurasian mainland except Taymyr peninsula were not affected by the Ice Sheet during Last Glacial Maximum (Hubberten *et al.*, 2004).

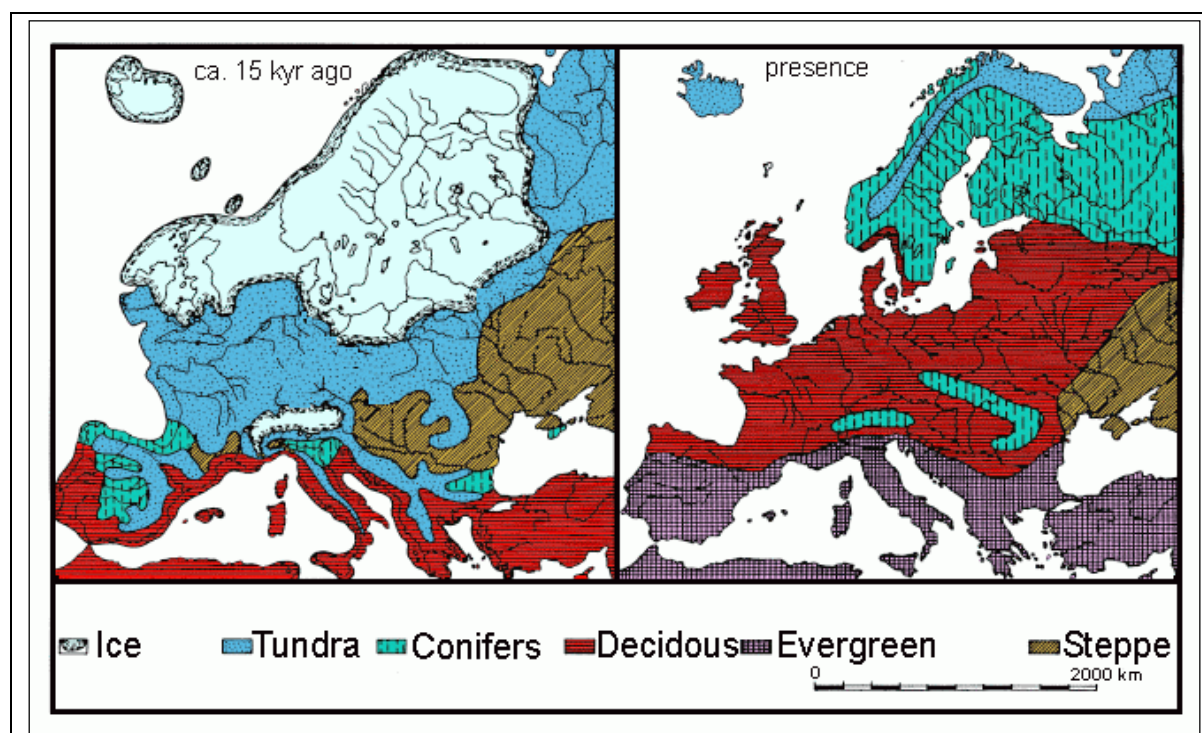

Fig. 1. The position of Ice Calote during last Glaciation Maximum and the main vegetation type distribution during last glaciation and in presence.

The most of Eastern Europe across Siberia and into Alaska, and Siberia was enjoying some type of temperate climate. The south European alpine ice sheets were disunited and present in all higher mountains (the Pyrenees, the Alps, the Dinarids, the Scardo-Pinds, the Carpatians and the Balkan mountains). However, the area covered and glaciers reach-lowlands were different due to different geographical position, relief and paleoclimate.

The reasons for the glaciers dynamics are Orbital or Milankovićs oscillations (eg. Maslin *et al.*, 1998).

Also, there is paleoclimatic evidence that there have been two branches of atmospheric circulation, both bringing warm air, one going towards the North Atlantic basin, and the other weaker going to Eurasia, following Mediterranean coast entering Central Europe (Hubberten *et al.*, 2004). Cold and dry flow coming from Scandinavia results eastern parts of Eurasia to be polar desert to tundra-steppe (Hubberten *et al.*, 2004).

1.2. EFFECTS OF GLACIATIONS ON BIOTAS

Few plants can survive the rigorous environment of coldness. Moss species are the dominant plants even nowadays in such environment like Antarctica, along with some lichens and algae (Smith, 1984, 1993; Walton, 1990; Skotnicki *et al.*, 2004). Mosses grow at the limits of any plant's tolerance of extremes – drought, cold and wind as well as light (Skotnicki *et al.*, 2000).

Thus, bryophytes survived many ecological, for other organisms, catastrophic changes, at first places climate oscillations. Variations in the Earth's orbit with periods of 10-100 thousand years (kyr) (Milanković oscillations) have led to recurrent and rapid climatic shifts throughout Earth's history. These cause changes in the geographical distributions of organisms (Jansson and Dynesius, 2002). Climatic

shifts cause extinction, splitting and merging of gene pools and populations. They select among individuals and clades for traits enhancing the ability to survive *in situ* and to establish new populations.

Research in recent decades has led to a major expansion in the knowledge of long-term climatic variability and of how some organisms respond to such changes. The discovery that Earth's climate varies with variations in its orbit (Hays *et al.*, 1976; Berger, 1988; Imbrie *et al.*, 1993) revolutionized modeling of past climates (Wright *et al.*, 1993). Owing to increased sampling of fossils and new dating techniques, it is now possible to document evolutionary responses and changes in the distribution of organisms in relation to climatic events (Bennett, 1997). The combination of methods and ideas from genetics, systematics, and biogeography in the field of phylogeography (Avice, 2000) has also made it possible to infer past changes in geographical distributions and levels of gene flow from patterns of genealogical relatedness among clades (Cruzan and Templeton, 2000). All this new information has led to the realization that recurrent climatic changes affect evolution and cause biogeographical and macroecological patterns (Hewitt, 1996; Bennett, 1997; Dynesius and Jansson, 2000).

Beyond seasonal changes, the amplitude of climatic changes increases towards longer timescales but has marked peaks on the timescales of 10-100 thousand years (kyr). These climatic variations are caused by periodical changes in Earth's orbit, called Milanković oscillations, resulting from gravitational interactions with other planets in the Solar System, primarily Jupiter because of its size and Venus because of its proximity to Earth (Berger, 1988). The tilt of Earth's axis varies with a 41 kyr period, the eccentricity of the orbit varies with a 100 kyr period and the annual timing of minimum Earth-Sun distance varies with 19 and 23 kyr period (Berger, 1988). Combined with earthbound feedbacks from, e.g., atmospheric CO₂, global ice volume, and surface albedo, the variations in insolation produce large, rapid, non-linear climatic changes (Berger, 1988; Imbrie *et al.*, 1989, 1993) and stable

conditions generally lasting only a few thousand years at a time (Imbrie *et al.*, 1989; Webb and Bartlein, 1992; Wright *et al.*, 1993). In fact, the climate during the present 10 kyr long interglacial period has been more stable than during glacial periods, which make up more than 90% of the Quaternary (Kukla, 2000). Superimposed on orbital variation, there are millennial-scale climatic variations, which have been more pronounced during glacial periods (Jansson and Dynesius, 2002). Milanković oscillations have been a feature of Earth's entire history, as documented in rhythmic sedimentation patterns having the same periodicity as orbital variations (Olsen, 1986; Zachos *et al.*, 1997, 2001), although the amplitude and the relative importance of variation in different orbital parameters have varied over time. Over millions of years, there are also long-term trends in Earth's climate caused largely by plate tectonics of oceanic and atmospheric flows determining the mean climate over many Milanković oscillations.

Thus, Milanković oscillations can be cause for ranges of many recent and extinct life forms. Summarizing present knowledge mostly based on higher plant and animal species can be given as follow:

Paleoecological studies show that the dominant responses to recurrent climatic shifts of species and other clades recognizable in the fossil record have been changes in the size and location of their geographical distributions (Davis, 1976; Coope, 1979; Huntley and Birks, 1983; Cronin *et al.*, 1996; Roy *et al.*, 1996). Such range fluctuations have occurred globally, although the magnitude of change has varied tremendously among regions (Bennett, 1997). Dynesius and Jansson (2000) named changes in geographical distributions in response to Milanković climate oscillations "orbitally forced species' range dynamics." However, the term applies to clades at any level of genealogical inclusiveness, from single gene pools to phyla, and therefore Jansson and Dynesius (2002) proposed new term that should be more generally rephrased "orbitally forced range dynamics" (ORD). ORD entail advances and retreats of range limits and also movements and extinctions of genes,

genotypes, and subclades in nonmarginal parts of the geographical ranges caused by the moving environmental gradients. The magnitude of climatic change varies geographically owing to variation in the amplitude of insolation change and to spatially varying effects of the earthbound feedbacks. For example, the 41- and 100-kyr oscillations cause larger temperature changes toward the poles (Imbrie *et al.*, 1989; Wright *et al.*, 1993), causing more ORD (Bennett, 1997). For example, plant taxa in tropical rain forests persisted locally in large proportions of their ranges during the last glacial period (Flenley, 1998). In contrast, tree taxa of the temperate deciduous forests of the Northern Hemisphere were often restricted to small refugia during the last glacial period and have since expanded up to many thousands of kilometers (Davis, 1976; Huntley and Birks, 1983). The latitudinal gradient in the 100-kyr oscillations is caused by earthbound feedbacks, whereas the 41-kyr orbital oscillations intrinsically lead to a latitudinal gradient in insolation change (Imbrie *et al.*, 1989, 1993; Wright *et al.*, 1993). Therefore, it is assumed that a latitudinal gradient in ORD has been continuously present (Jansson and Dynesius, 2002). Local to regional factors can buffer against regional climatic change. For example, tropical mountain cloud-forests have generally been considerably less climatically variable than the region to which they belong because local factors lead to persistent mist and cloud formation (Fjeldsa *et al.*, 1999). Oceanic islands are generally little affected by Milanković climate oscillations at least in tropical latitudes (Cronk, 1997). Steep physical gradients reduce ORD because organisms only have to move short distances as temperature, moisture conditions, or water levels change (Darlington, 1943; Brown, 1995; Hewitt, 1996). The prime examples are steep slopes, both on land and under water. Both local moderation of climate variability and steep gradients were probably important for the survival of tree species in the mountains of southern Europe during glacial periods (Bennett *et al.*, 1991). All else being equal, the lower the magnitude of climatic change, the larger the area continually inhabited by a clade. Those of the clade's gene pools that are in such areas will exhibit low levels of ORD.

A gene pool is the pool of genetic information carried by all individuals in a population. A gene pool and all its descendant gene pools constitute a clade (Williams, 1992). Evolution is affected by sorting among genetic variants at any level of genealogic inclusiveness (Williams, 1992). The evolutionary effects of climate change vary with genealogic inclusiveness and are thus spatially and temporally scale dependent. Individual gene pools occupying small areas are more likely to be strongly affected by climate shifts than more inclusive clades occupying larger areas. Jansson and Dynesius (2002) state that the higher amplitude of climatic fluctuations causes more dynamics in size and locations of ranges of biota and this makes higher vagility, less specialization, larger range size of old biota and higher extinction rate. In contrast, higher vagility, less specialization and larger range size reduce extinction rate. On the other hand, more dynamics in size and location of ranges bring more clade to be formed by polyploidization.

Given that populations are locally adapted, changes in climate and associated biotic and abiotic factors should alter fitness optima of population phenotypes throughout the range of the clade (Davis and Shaw, 2001). In response to this, local populations may either go extinct, adapt to the new conditions *in situ*, or individuals may disperse to and establish new populations in environments that have become suitable (Jackson and Overpeck, 2000). Gene flow may increase as individuals from previously separated populations come into contact and interbreed (Futuyma, 1987). The type of response depends on the magnitude and rate of the climatic change, but traits and locations of the organisms are also important.

1.2.1. Selection for vagility

When climate changes, range boundaries may advance.

Marginal populations at range boundaries may become sources for new populations beyond the present range boundary. Phenotypes with high vagility (i.e., high dispersal ability and propensity) are more likely to found new populations and to initiate range advances. The descendents of the individuals arriving first pre-empt

suitable habitats to the disadvantage of organisms arriving later (Hewitt, 1999). This leads to selection for vagility, provided differences in vagility are heritable. Repeated founding events after long-distance dispersal would result in rapid directional selection for vagility (Cwynar and MacDonald, 1987). Range advances are often achieved by long-distance dispersal. For example, the observed rapid advances in the beginning of the Holocene of north temperate tree taxa can only be explained this way (Skellam, 1951; Cain *et al.*, 2000). In such situations, selection for vagility should primarily affect traits associated with the tail of dispersal curves.

Selection against vagility owing to local adaptations, dispersal-related mortality, and (at least among flying insects) tradeoffs with reproductive investment are ubiquitous. What about long-distance dispersed mosses? Even more, those that rarely produces gametes, spores or diaspores?

1.2.2. Selection for the low specialization

Organisms differ in the width of their environmental tolerance, habitat and resource specialization, and in how dependent they are on specific species (Futuyma and Moreno, 1988). Less specialized, more tolerant individuals are more likely to find suitable habitats, establish in new areas, and survive while moving through heterogeneous environments. Thus, range advances should select for low specialization and wide tolerance. This conclusion is supported by a spatially explicit patch-occupancy model (Bowers and Harris, 1994). In the model a broad-niched generalist species was able to track environmental changes better than a specialist species. In constant or slowly changing environments the specialist species was favored owing to better competitive abilities, but with moderate or rapid environmental change, the generalist species was able to limit the ability of the specialist to survive and/or track the shifting environment.

Improved environmental conditions at existing range boundaries are likely to initiate range advances without any evolutionary change. Once the advance is initiated, individuals that advance most rapidly are likely to be favored. Advancing range fronts

become characterized by dispersive generalists or by specialists on habitats common in the colonized area (Thomas *et al.*, 2001).

1.2.3. Interbreeding during range advances.

Individuals from previously separated populations of sexual organisms may come into contact and interbreed during range advances. This may result in hybrid speciation (e.g., polyploidization) or various degrees of introgression between differentiated gene pools or clades. Introgression may be counteracted by the formation of hybrid zones (Remington, 1968; Hewitt, 2001).

The same processes as those at work during advances of range limits are active in other parts of the range where climate changes. However, populations in other situations are more likely to go extinct without leaving offspring during climatic change. Organisms may fail to establish new populations, either because they cannot move fast enough, because they encounter barriers (Brown, 1995; Ashworth, 1996), or because the preferred habitat becomes rare or temporarily disappears regionally. Establishment in new areas with suitable habitat may also be impeded by competition from individuals of the same clade already present before the change. Survival *in situ* is hampered by competition with immigrants better adapted to the new environment at that site. Again, all this may lead to selection for high vagility and low specialization. Low specialization is selected for because it is less likely that the niche of such individuals will disappear completely in an area (McGlone, 1996, Jackson and Overpeck, 2000). Moreover, less specialized organisms do not need to disperse as rapidly to track their habitat. If peripheral populations go extinct, range limits retreat.

The probability of long-term survival varies among clades depending on characters of organisms, e.g., degree of specialization and vagility. Generalism and high vagility promote high population densities and wide distributions. All these factors are positively correlated with low extinction rates at the level of species or higher

taxonomical rank (McKinney, 1997). There is also non-adaptive sorting caused by the large geographic variation in range dynamics. Clades that are in the right place, i.e., in areas demanding the least distributional change, have higher probability of surviving climatic shifts and should thus have higher fitness over long timescales. Oceanic islands have high proportions of paleoendemics, which have disappeared from continents, probably because stable climates and poverty of competitors and exploiters have allowed island clades to persist longer (Cronk, 1997). For most taxa of European forest trees, only clades that persisted during both glacial and interglacial times in southern and south-eastern Europe have living European representatives (Bennett *et al.*, 1991). The northern populations of most taxa went extinct *in situ* during the glacials. In the beginning of interglacials northern Europe was colonized from southeastern and southern refugia (Bennett *et al.*, 1991). There are very few data if the same fate was for bryophytes as well.

There is a wide range of mechanisms, abiotic as well as biotic, that could lead to separation of gene pools in sexual organisms (Jansson and Ddynesius, 2002). The separation occurs when gene flow is reduced or prevented by barriers to dispersal (allopatrically), distance (parapatrically), disruptive selection (sexual or ecological) within a locality (sympatrically), or abrupt speciation (e.g. polyploidization). If range dynamics is low, gene pools are more likely to survive and remain separated. Moreover, organisms may specialize and evolve reduced dispersal abilities without going extinct. This leads to decreasing gene flow, further favoring the integrity of gene pools and leading to radiation. However, there are many uncertainty when applicate these postulate to bryophytes which do not have or express sexuality.

Dynamics of range caused by glaciations and interglaciations should favor gene pool splitting in three principal ways: (a) by creating physically separated (allopatric) gene pools, (b) by favoring expansion into new areas where parapatric divergence can start, and (c) by causing a paucity of specialized organisms, leaving resources underexploited and thereby making ecological divergence in sympatry more frequent

(Schluter, 2000). Also, reproductive barriers can play significant role in clade evolutions. Reproductive barriers make clades resistant to merging with other clades, thus increasing clade persistence. Reproductive barriers may evolve gradually over many generations (allopatrically, parapatrically or sympatrically) or form abruptly, e.g. by polyploidization (Mayr, 1963).

1.3. MOLECULAR TRACING OF POPULATION RELATIONSHIPS AND PAST MIGRATION EVENTS: INSIGHTS FROM THE NUCLEAR RIBOSOMAL DNA INTERNAL TRANSCRIBED SPACER (ITS) AND PLASTID NON-CODING DNA REGIONS (*trnL-F* SPACER AND INTRON)

Phylogeographic studies at and below the population level in plants are still uncommon. This is in part due to low levels of variability in DNA sequence data and recent investigations suggest that the nuclear ribosomal Internal Transcribed Spacer regions may have some value in plant phylogeographic studies (Barker *et al.*, 2003) as well as some non coding regions of plastid DNA, e.g. *trnL-F* introns and spacers regions (Taberlet *et al.* 1991; Vogel *et al.*, 1996; Vogel *et al.*, 1998; Kelchner 2000;). Furthermore, it has been shown that chloroplast is maternally (i.e. uniparentally) inherited in most plants (Vogel *et al.*, 1998).

Gene genealogies offer great promise for furthering our understanding of plant evolution (Schaal *et al.*, 1998), and when genetic variation is organised into a genealogy, with subsequent overlay of geography, the resulting analysis has been called "intraspecific phylogeography" (Templeton *et al.*, 1995). In a phylogeographic analysis, genealogical lineages are used to make inferences about the principles and processes that have resulted in geographical distribution (Avice, 1998, 2000; Schaal *et al.*, 1998; Schaal and Olsen, 2000), in a process that tracks geographical divergences along a phylogenetic tree (Smouse, 1998). The success of a phylogeographic analysis is dependent on the integrity of the phylogenetic tree, as well as the interpretation of congruence between the phylogeny and geographical distribution (Schaal *et al.*, 1998). Pictorial overlays of haplotype network upon

geography are currently the standard inference tool for intraspecific phylogeography (Templeton *et al.*, 1995). Such pictorial representations usually find a strong association between the geographic location of haplotypes and their evolutionary position within a gene tree, but the demonstration of such an association *per se* does not reveal the causes of the association (Templeton *et al.*, 1995).

The ability of phylogeographic methods to detect geographic associations depends upon there being resolution in the haplotype tree, and historical events cannot be older than the coalescence time for the gene region being investigated (Templeton *et al.*, 1995). However, in order to construct gene trees (for phylogeographic use), significant genetic variation must occur at the appropriate level; *i.e.* among the populations or taxonomic units being investigated (Schaal *et al.*, 1998). In the search for highly informative markers within a single species, genetic markers with recurrent mutation rates high enough to yield multiple mutations over the time-frame of interest must be chosen (Smouse, 1998).

Phylogeographic studies in plants have lagged behind those in animals, primarily because of difficulties in finding ordered, neutral intraspecific variation required for constructing gene trees (Olsen and Schaal, 1999; Schaal and Olsen, 2000). Detection of “phylogenetically informative” intraspecific variation is probably the most difficult problem facing plant population biologists wanting to reconstruct population history (Schaal *et al.*, 1998).

High-resolution nuclear markers such as RAPDs and AFLPs (Vos *et al.*, 1995) are historically unordered, probably confounding phylogenetic reconstruction (Smouse, 1998; Schaal and Olsen, 2000, Koopman *et al.*, 2001). An alternative source of variation, the non-coding regions of single copy or low copy number nuclear genes, could potentially provide multiple, unlinked allele genealogies at the intraspecific level (Olsen and Schaal, 1999), but they have not yet been extensively studied in plants and certainly not in bryophytes.

The chloroplast genome is non-recombining and uniparentally inherited, and is thereby useful for tracking haplotype lineages and discriminating between maternal and paternal contributions to offspring. In contrast, nuclear genes are recombining, biparentally inherited markers, thereby allowing simultaneous observation of maternal and parental contributions to offspring, exposing gene flow and hybridisation events that may not be revealed by analysis of an organellar genome or single genealogy alone (Mayer and Soltis, 1999).

Most attempts to detect intraspecific variation suitable for phylogeographic studies in plants have relied on the chloroplast genome (Olsen and Schaal, 1999). Plastid gene sequences generally exhibit low rates of sequence evolution (Palmer, 1987; Downie and Palmer, 1992; Doyle, 1995), especially when compared with animal mtDNA, a feature limiting its applicability (El Mousadik and Petit 1996). However, by the early 1990's there was ample (largely RFLP) evidence that there was substantial intraspecific variation in the chloroplast genome that could potentially be exploited for phylogeographic studies. Soltis et al, (1992) provide a substantive summary, and include references to many intraspecific studies. The rise and subsequent prevalence of DNA sequencing studies have shown that several regions of the chloroplast genome (such as some intergenic spacers) show potential for phylogeographic analysis, although attempts by Schaal *et al.* (1998) indicate that single cpDNA loci are only occasionally useful at the intraspecific level. Approximately half of all cpDNA mutations are short indels (1-10 bases), located primarily in the noncoding regions of the chloroplast genome (Zurawski *et al.*, 1984; Kanno and Hirai, 1992). In many cases, the chloroplast spacer regions that have been informative for some plant species show little or no intraspecific variation in other species (Schaal and Olsen, 2000).

Studies of noncoding chloroplast DNA sequences have shown that insertions/deletions of more than two bases that do not belong to tandem repetitions

are good phylogenetic markers (Gielly and Taberlet, 1994a; 1994b). Weising and Gardner (1999) published a set of conserved primers that allow the characterisation and genotyping of individuals and populations within a species based on chloroplast simple sequence repeat polymorphisms. Applications of this approach have proved successful in phylogeographic studies (see for example Marshal *et al.*, 2002; Collevatti *et al.*, 2003).

The effective population size of a nuclear gene is four times that of an organelle gene, because it is diploid and bi-parentally inherited (Schaal and Olsen, 2000). This larger effective population size results in larger coalescence times, and because nuclear DNA (nDNA) evolves more slowly than organellar DNA (Palumbi *et al.*, 2001), this in turn increases the likelihood of encountering ancestral polymorphisms (Avice 2000; Schaal and Olsen, 2000). The utility of nuclear gene (*e.g.* intron) sequences in intraspecific phylogenetic analyses appears to be limited by this increased coalescence time (and associated variance) as compared to mitochondrial and chloroplast genes. In addition, the potential for reticulate evolution among nuclear alleles due to recombination (Bermingham and Moritz, 1998) is likely to further limit their utility for phylogeographic studies. These considerations are valid but slightly different for haploid none sexually dispersed clades, *i.e.* bryophytes.

When using organelle genes in comparison to nuclear genes, several factors contribute towards an increase in genetic structure within a plant species. Firstly, effective gene flow is limited to seeds for maternally inherited genomes (Petit *et al.*, 1993). Secondly, in hermaphroditic species such as the oaks, the flowering and fruiting pattern results in the effective number of trees contributing towards the next generation as females, being less than the effective number of trees acting as males (Demesure *et al.*, 1996; Dow and Ashley, 1996). Thirdly, drift is twice as strong for a haploid genome as compared to a diploid one (Dumolin-Lapègue *et al.*, 1997).

For both phylogenetic and phylogeographic purposes it would be desirable to consider multiple gene trees based on chloroplast and nuclear genomes, because independently derived gene trees may not be congruent (Schaal *et al.*, 1998). However, Doyle (1997) warns that when the history of the organellar genome is different from that of the nuclear genome (e.g., in lineage sorting or introgression) every nucleotide in every one of the organellar genome's genes will give the "wrong" phylogenetic pattern for those taxa affected.

Plant molecular phylogenetic studies at species levels are generally limited by the availability of sequences with the right level of resolution suitable for the construction of well-supported trees (Doyle *et al.*, 1996). Single sequences are of limited value when recombining diploid genomes in populations (Bachmann, 1997). This limitation can be overcome by sampling sequence polymorphisms at many points throughout the nuclear genome in order to obtain multilocus genotypes. Various molecular methods have been designed to resolve this (Karp *et al.*, 1996; Bachmann, 1997). Ultimately the full potential of phylogeography will be realised when multiple loci are considered together (Schaal *et al.*, 1998). Because of the difficulty in finding genealogically informative markers, many plant studies have been phylogeographic only in the broad sense, i.e. they detect an association between patterns of genetic variation and geography, and do not incorporate a genealogical perspective (Schaal and Olsen, 2000).

1.3.1. Plant DNA Sequence Markers Suitable for Phylogeographic Studies.

Chloroplast DNA restriction site data meet the requirement of sampling the genome at many points, and this technique has been used extensively in phylogenetic studies at and above the species level. However, use of DNA sequence data has numerous technical advantages over restriction mapping (Doyle *et al.*, 1996), and has thus become the preferred approach for phylogenetic studies. Efforts have been made to identify relatively rapidly evolving chloroplast sequences for use in DNA sequence-

based phylogenetic studies, and the publication of primers to non-coding regions (e.g. Taberlet *et al.*, 1991; Demesure *et al.*, 1995; 1996) have greatly aided both phylogenetic studies at the lower taxonomic levels, as well as phylogeographic studies. Early plastid-based phylogeographic studies (e.g. Ferris *et al.*, 1993; McCauley *et al.*, 1996) or phylogeographic studies with very large sample sizes for which DNA sequence data would be very costly to generate (e.g. Demesure *et al.*, 1996; El Mousadik and Petit, 1996; Grivet and Petit, 2002) utilise an alternative PCR-RFLP approach.

Published phylogeographic studies using chloroplast DNA sequence data are as yet not common, but recent examples include a study on the cycad *Cycas taitungensis* (Huang *et al.*, 2001), the fern *Asplenium ceterach* (Trewick *et al.*, 2002), and the angiosperms *Cyclamen* (Gielly *et al.*, 2001), *Kandelia candela* (Chiang *et al.*, 2001), *Armeria* (Gutierrez-Larena *et al.*, 2002), *Fagus crenata* (Fujii *et al.*, 2002), and *Cyclobalanopsis glauca* (Huang *et al.*, 2002). Among the bryophytes there are just a few phylogeographic study using chloroplast DNA regions (e. g. *trnL* concerning *Hypopterygium rotundum*; Pfeiffer, 2000a); *rps4* gene concerning *T. muralis* (Werner and Guerra, 2004).

The ideal nuclear gene to use for phylogeographic studies would be a single-copy gene, so as to avoid potential problems that multiple paralogues can cause in phylogeny estimation. Sang (2002) reviews the utility of low-copy number nuclear genes in plant phylogenetics, but it appears that the number of nuclear genes or regions suitable for comparative sequence studies at lower taxonomic levels is limited. Examples used for phylogenetic studies, but potentially useful for phylogeography, include the Histone H3 intron sequences (Doyle *et al.*, 1996), the glyceraldehyde 3-phosphate dehydrogenase gene (G3pdh; Olsen and Schaal, 1999; Schaal and Olsen, 2000), and the chloroplast- expressed Glutamine Synthetase gene (ncpGS; Emshwiller and Doyle, 1999). The ncpGS gene contains several introns, and appears to be single copy in most taxa. Levels of variation among the

ncpGS sequences compare favourably with those of the rDNA internal transcribed spacers (Emshwiller and Doyle, 1999). However, these high evolutionary rates also necessitate group or lineage specific primer development.

Extensive use has been made of the multicopy nrDNA genes and allied non-coding regions for phylogenetic studies in plants, mainly because of the near-universality of the primers designed to anneal in highly conserved regions (Gerbi, 1985; White *et al.*, 1990; Hamby and Zimmer, 1992; Cullings and Vogler, 1998). Probably for this reason alone, the internal transcribed spacer (ITS) region of the 18S – 26S ribosomal repeat is one of the most commonly sequenced regions in plant systematics. The 18-26S ribosomal DNA repeat is further attractive for phylogeny reconstruction because of its high copy number, rapid concerted evolution, and diverse rates of evolution within and among component subunits and spacers (Hamby and Zimmer, 1992; Baldwin, 1992, and literature therein).

The nrDNA Intergenic Spacer Region (IGS) consists of two parts, the non-transcribed spacer (NTS), and the external transcribed spacer (ETS), which is adjacent to the 5'–end of the 18S gene (Volkov *et al.*, 1996). The ETS part of the IGS contains different regulatory elements necessary for the initiation and termination of transcription. This region evolves far more rapidly than the nrDNA coding regions, and may thus differ between species, populations and even individuals within a population (Volkov *et al.*, 1996).

The reason why the ETS is not used more frequently for comparative studies in plants is probably the lack of a highly conserved region for primer design flanking the 5' end of the spacer (Baldwin and Markos, 1998). Although the highly conserved 18S gene offers various options for primer sites downstream from the 3' end of the ETS, the highly variable non-transcribed spacer (NTS) borders the 5' end of the ETS and is too rapidly evolving in sequence and length to provide a universal primer site for most plants. Baldwin and Markos (1998) overcame this limitation by using long-

distance PCR to amplify the entire IGS (NTS + ETS) using universal primers that bind to the flanking and highly conserved 18S and 26S sequences.

The ETS of the IGS regions of angiosperms is longer than ITS-1 and ITS-2 regions combined and, based on restriction site data, appears to evolve at least as rapidly as the ITS at the nucleotide level (Baldwin and Markos, 1998). The level of subrepeat identity within the ETS region in the Solanaceae ranges from 57% to 92% (Volkov *et al.*, 1996), and ETS length difference among species of *Nicotiana* may be due to variation in the number of these subrepeats (Volkov *et al.*, 1996). ETS and ITS regions have been successfully used in tandem in a number of phylogenetic studies (Baldwin and Markos, 1998; Bena *et al.*, 1998; Clevinger and Panero, 2000; Markos and Baldwin, 2001; Li *et al.*, 2002), and ETS alone in a few (Volkov *et al.*, 1996; Linder *et al.*, 2000; Markos and Baldwin, 2002).

1.3.2. Internal Transcribed Spacer of the nuclear ribosomal DNA

The nrDNA ITS regions (Fig. 2) exhibit a rare combination of highly conserved primer sites adjacent to highly variable sequences (Bachmann, 1997), and is therefore extremely useful for PCR amplification using “universal” primers (White *et al.*, 1990).

It seems probable that ITS-1 and ITS-2 are under some functional constraint in structure and sequence, as suggested by size and GC content comparisons among angiosperms (Baldwin *et al.*, 1995; Goertzen *et al.* 2003) and therefore useful for phylogeny reconstruction at lower taxonomic levels.

At present, the ITS regions are technically the most convenient and universally accessible nuclear DNA sequences with sufficient variation to distinguish species of a genus or even populations of a species (Bachmann, 1997). The ease with which ITS sequence information can be obtained makes it a valuable nuclear DNA resource for comparison with cpDNA phylogenetic data in angiosperms (Baldwin, 1993).

The ITS region has been shown to be evolutionarily conservative in length, as opposed to the IGS, which varies extensively in length (Hamby & Zimmer 1992). The conservation in length and high nucleotide sequence variability contributes to the appeal that this region has for systematic studies.

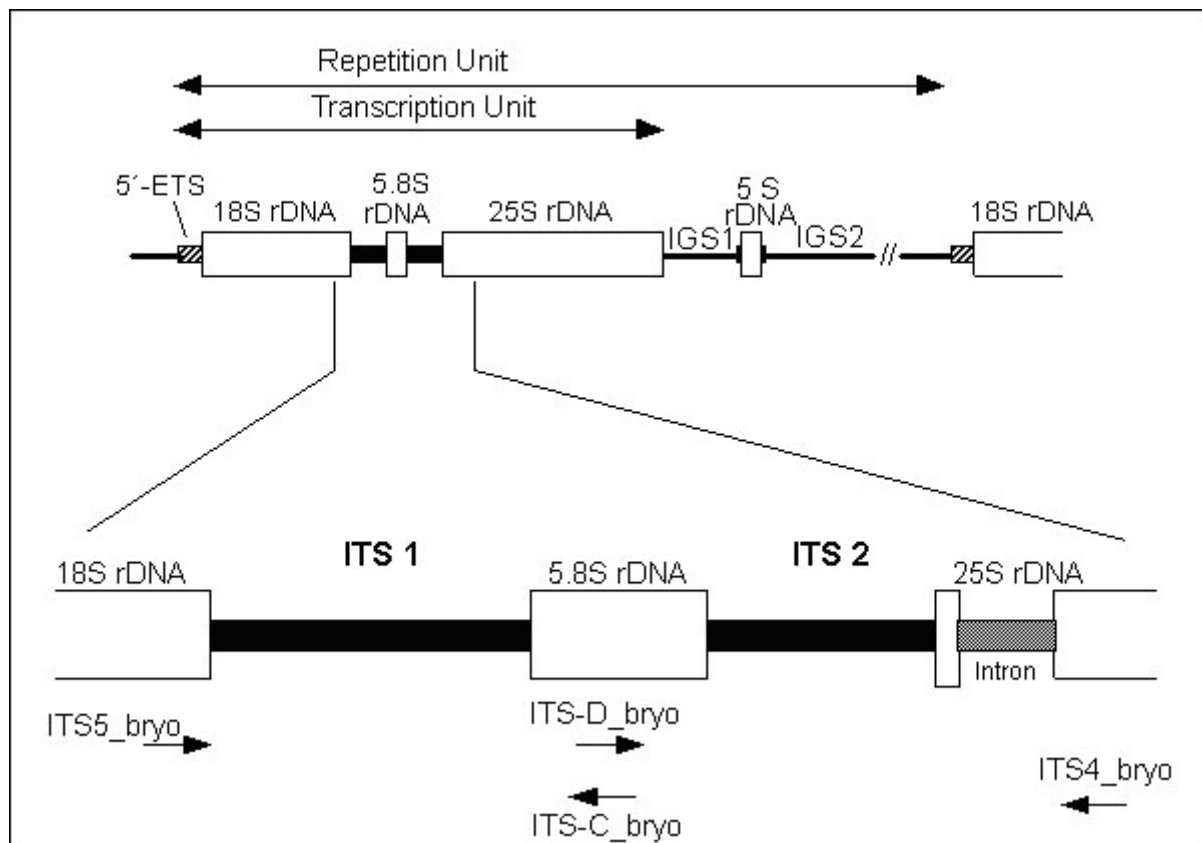

Fig. 2. The Schematic presentation of the nuclear ribosomal Internal Transcribed Spacer (ITS), with transcription and repetition units, and primers used within bryophyte DNA.

However, its use at the intraspecific level is debatable, and at least some species with long life spans show reduced levels of sequence divergence (e.g. Sang *et al.*, 1995).

Apart from a possible size limitation that may result in relatively small numbers of phylogenetically informative characters, there are other factors that may limit the applicability of nrDNA ITS sequences in phylogeographic studies. Biological factors include aspects such as reticulation, hybridisation and polyploidy, while concerted evolution can be considered an intracellular biochemical factor that ensures the homogenisation of the multiple sets of rDNA repeats.

Reticulation, hybridisation and polyploidy are all mechanisms which introduce “unwanted” variation (in a phylogeny reconstruction context). This variation may take the form of paralogous copies of nuclear genes, and this can confound phylogenetic reconstruction. The relevance of these factors to the applicability of ITS sequences at the plant species level is shortly discussed below.

Reticulation. Micro-evolutionary processes such as gene flow and lineage sorting can result in reticulate patterns of relationship among populations (Mayer and Soltis, 1999). Furthermore, if gene flow leads to heterozygosity of ITS types within an individual (which would happen if maternal and paternal contributions were not identical in sequence structure), subsequent recombination or partial gene conversion can disrupt phylogenetic signal in the ITS genealogy (Sang *et al.*, 1995). As noted above, the application of nuclear gene sequences in phylogeographic analyses appears to be limited by the increased coalescence time compared with organellar gene sequences and the potential for reticulate evolution among nuclear alleles due to recombination (Bermingham and Moritz, 1998). Unambiguous phylogeographic signal will thus only be expected if there has been extended population isolation. Gene flow, through either pollen or seed, will potentially disrupt the divergence of nuclear sequences, whereas (in plants with maternal plastid inheritance) gene flow through seed dispersal only will affect organellar gene divergence. As ITS is biparentally inherited, either pollen or seed dispersal will thus contribute to disruptive gene flow. Studies of both genomes can therefore be

informative about pollen versus seed dispersal as the cause of gene flow (Ennos, 1994; El Mousadik and Petit, 1996).

Hybridisation and Polyploidy. While hybridisation can be a threat to species integrity, it can also be a source of new variation and a source of new species, especially through polyploidy (Grant, 1953). It is now commonly accepted that polyploidy is a highly effective evolutionary mechanism for introducing new plant species, promoting their persistence and survival, and ultimately increasing the diversity of plant species (Cook *et al.*, 1998; Otto and Witton, 2000; Ramsey and Schemske, 1998; Soltis and Soltis, 1999; Wendel, 2000). Furthermore, hybridisation may provide a stimulus for the evolution of invasiveness (Ellstrand and Schierenbeck, 2000). It is estimated that between 20% and 70% of angiosperm species are polyploid.

Under traditional views, polyploidy was considered largely an evolutionary dead end; however a growing body of evidence suggests that recurrent polyploidisation is the rule rather than the exception (Cook *et al.*, 1998), and that polyploidy can confer evolutionary advantages on plant species (Doyle, *et al.*, 1999). Most polyploid species of plants that have been examined with molecular markers have been shown to be polyphyletic, having arisen multiple times from the same diploid species (Soltis and Soltis, 2000). Such recurrent formation of a polyploid species has implications for the taxonomy of polyploids, the genetic diversity of polyploid 'species', and for an understanding of the ease with which and rate at which polyploidisation can occur (Soltis and Soltis, 2000). Any hybridisation event (be it between different species or different populations within a species) that results in a plant that can produce viable offspring will introduce a mix of ITS paralogues from both parents. This would introduce new copies of ITS genes also disrupt the divergence of the any nuclear sequences. Studying the diversity of ITS copies in a polyploid genome (or any diploid genome for that matter) can best be done by the cloning of PCR products and subsequent sequencing; something that direct PCR-sequencing cannot do. However, this can be time consuming and costly, and Rauscher *et al.* (2002) present a novel

approach using repeat-specific primers to recover rare parental ITS sequences from polyploid species.

Concerted evolution. Concerted evolution has been proposed as a process that homogenises multiple copies of a gene, such that all copies become identical (Arnheim *et al.*, 1980; Zimmer *et al.*, 1980; Arnheim, 1983; Weising *et al.*, 1995; Bachmann, 1997; Schaal *et al.*, 1998; Aguilar *et al.*, 1999a). During this homogenisation process, either the paternal or maternal copies are retained to the exclusion of those from the other parent. Aguilar *et al.* (1999b) found that in Plumbaginaceae concerted evolution can be complete as quickly as one generation after the combination of two parental ITS types. They also suggest that the fast rate of homogenisation in (artificial) hybrids has important implications for detecting past or recent hybrid events in natural populations. However, in *Gilia achilleifolia* (Polemoniaceae), Morrell and Rieseberg (1998) were able to resolve samples of *G. achilleifolia* as sister to the putative parent species, suggesting this process is not always rapid. Thus in terms of phylogeny reconstruction using rDNA ITS sequence data, a specimen of hybrid origin will be resolved either as a mixed set of paralogues or as related to one of the two possible parents. Under the latter scenario, the means to depict or detect hybrid history will be lost, and this can happen sometimes as rapidly as within a few generations (Sang *et al.*, 1995; Wendel *et al.*, 1995). ITS data has, however, been successfully used to show multiple hybridisation events in populations of *Arabis divaricarpa*, and concerted has resulted in a range of ITS types in both the hybrid and parent taxa (Koch *et al.*, 2003). Furthermore, these workers report intra-individual variation in ITS copies.

In general nuclear ribosomal DNA variation gives many possibilities in studying evolution and ecology of living organisms (Weider *et al.*, 2005).

Concerted evolution can thus be invoked as possible the cause of incongruence between phylogenetic reconstructions using nrDNA and other characters (Bachmann, 1997). For these reasons, the phylogenetic interpretation of ITS

sequences at the species level is considerably less straightforward than those of chloroplast DNA polymorphisms.

Potential for ITS in Intraspecific and Phylogeographic Studies. Schaal *et al.* (1998) suggested that the ITS region of ribosomal DNA is generally not considered useful for phylogeographic studies in angiosperms because, for most species examined, intraspecific ITS variation has not been detected, and the poorly understood process of concerted evolution can confound the interpretation of sequence polymorphism at the intraspecific level. In ITS-based molecular phylogenetic studies at the species level, the inclusion of more than a single representative sample per species is rare, but where done, variation in ITS sequences may be found (see for example Baldwin, 1993). The sentiment of Schaal *et al.* (1998, cited above) might have been somewhat premature, as among the land plants, recent ITS-based phylogeographic studies have been successfully applied to species and species complexes in a number of divisions. ITS appears to be particularly useful in bryophyte studies (Shaw, 2000; Shaw *et al.* 2003a). Within the gymnosperms the ITS 1 & 2 units are highly variable in size (Liston *et al.*, 1996). However, in the gymnosperm *Podocarpus latifolius*, (Barker *et al.*, 2004) found no variation in 250 base pairs of ITS2 sequence data from specimens across the distribution range. This finding that may be correlated to the observation (in monocotyledonous angiosperms; Gaut *et al.*, 1992, Clegg *et al.*, 1994) that substitution rates tend to be slower in groups with longer generation times (*Podocarpus* is very long lived).

However, while providing useful data in this regard, the phylogeographic utility of the ITS region is appreciated but limited by factors such as its multi-copy nature, hybridisation, polyploidy and concerted evolution.

1.3.3. *trnL* – *trnF* region of the plastid DNA

During the last decade a considerable amount of sequencing has been performed in order to address relationship among bryophytes, with the *trnT*-*F* (Fig. 3.) region being one of the most widely used regions. Even, the variability of the *trnT*-*F* region is comparably lower in bryophytes to some other plants and regions, much valuable information on relation among bryophytes groups and even populations are considered from this region (e.g. Hyvönen *et al.*, 1999; Buck *et al.*, 2000a, 2000b; De Luna *et al.*, 2000).

The *trnT*-*F* region of the chloroplast DNA (containing as a part *trnL*-*F* region) is located in the large single copy (LSC) region of the chloroplast genome in close proximity to *rbcl* and comprises the intergenic spacers between the tandemly arranged tRNA genes *trnT*_{UGU}, *trnL*_{UAA} and *trnF*_{GAA} and the *trnL*_{UAA} intron. Of the three non-coding parts mainly the *trnL* intron and the *trnL*-*F* spacer is still quite rare have been extensively sequenced while data of the *trnT*-*L* spacer is still quite rare.

Since its introduction into molecular systematics by Taberlet *et al.* (1991), the *trnL* intron has been considered appropriate for investigations at various taxonomic levels. High-level studies comprise inference of relationships among cyanobacteria, algae and land plants (Besendahl *et al.*, 2000; Simon *et al.*, 2003), thus evaluating the evolutionary history of the *trnL* intron, relationships of basal angiosperms (Borsch *et al.*, 2003) as well as the molecular evolution of the *trnL*-*F* region in land plants (Quandt *et al.*, 2004a). In bryophytes the intron has been used to clarify relationships of liverwort classes (Stech and Frey, 2001) and to investigate bryophyte relationships below the ordinal level, extending even to population studies.

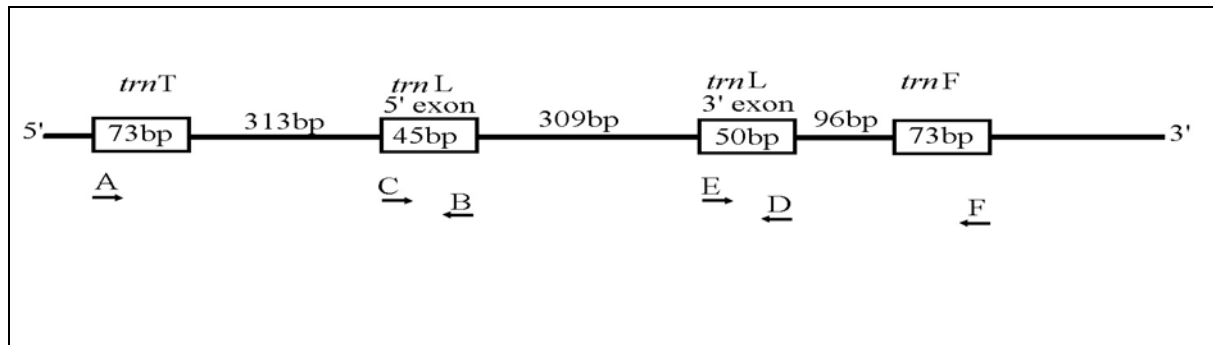

Fig. 3. The Schematic presentation of the chloroplast *trnT-F* region, with transcription, spacer and intron units, and primers used within bryophyte DNA.

1.4. BRYOPHYTE PHYLOGEOGRAPHY

Phylogeography has proven powerful in elucidating patterns of gene flow, hybridisation, historical range fragmentation, range expansion and speciation among many organisms (e.g. Avise 2000; Lessios *et al.*, 2001; Templeton, 2001, Bunje, 2005). However, rarely do phylogeographical analyses take into account the entire range or continent of some widespread species (Bunje, 2005). Most phylogeographical studies restrict their analyses to portion of a range. Investigating the wide or entire range of species is likely to reveal concurrent processes that act differentially to produce intraspecific phylogenetic structure (e.g. Bernatchez, 2001). The effect of geographically restricted mechanisms may be among the most important for bringing about speciation as allopatric processes are likely to produce populations that are less likely to inbreed with distant conspecifics (Knowels 2001; Bernardi *et al.*, 2003).

Phylogeographic analyses of bryophytes are significantly less considered than in vascular plants or animals. From the 1970s to the 1990s, isoenzyme analyses were used to study genetic diversity of bryophytes in relation to their distribution (e.g.

Wyatt *et al.*, 1989; Stoneburner *et al.*, 1991; Bischler and Bisselier-Dubayle, 1997). Shaw (1995) for example found that the widely but scattered distributed copper moss, *Scopelophila cataractae* (Mitt.) Broth was genetically uniform in Europe in contrast to the populations observed in Asia and North America, and he concluded that long-distance dispersal had probably played an important role in the geographic history of this moss. Odrzykoski and Szweykowski (1991) found that wide spread tallous liverwort *Conocephalum conicum* (L.) Dumort. consists of at least five geographic races in Asia, Europe and North America and Werner and Guerra (2004) similairly found 18 haplotypes for cosmopolitan moss *Tortula muralis* Hedw.. Other authors found in other bryophyte species little or no differentiation between Europe and North America: *Plagiomnium medium* (Bruch and Schimp.) T. J. Kop. var. *medium* (Stoneburner *et al.*, 1991), *Mielichoferia elongata* (Hoppe and Horsch.) Nees and Horsch. (Shaw and Schneider, 1995) and *Sphagnum majus* (Russow) C. E. O. Jensen (Sastad *et al.*, 2000). There is assumption that long-distance dispersal is explanation for low genetic distance. Some other explanations like that of Stenoien and Sastrad (1999), who have found lack of genetic distance between European and North-American populations of *Sphagnum angustifolium* (Warnst.) C. E. O. Jensen, consider low mutations rates, together with a large effective population size rather long-distance dispersal responsible for no genetic differentiation. Based on allozymes Cronberg *et al.* (1997) identified 79 genotype out of 258 plants of moss *Hylocomium splendens* (Hedw.) B. & S. analized just in Scandinavia. Cronberg (2002) studied the same species in Baltic lands and concluded that no isolation by distance was detected among populations, indicating efficient and essentially random gene flow, probably occurring via wind-dispersed spores. Finally, Cronberg *et al.* (2006) inferred that clonal structure and genet-level sex ratios suggest different roles of vegetative and sexual reproduction in the clonal moss *Hylocomium splendens*, which influence various genetic diversity over the range of this species.

Also, based on isozymes analyses Cronberg (1998) concluded that post-glacial migration from different refugia explain large-scale genetic variation in *Sphagnum*

rubellum Wils., similarly as Thinggaard (2001) did for *Sphagnum affine* Ren. & Card.. For *Sphagnum capillifolium* (Ehrh.) Hedw. Natcheva and Cronberg (2003) indicate high genetic differentiation even within same potential refugia in Bulgaria based on allozyme analyses.

Cronberg (2000) investigated twelve populations of *Leucodon sciuroides* Schwaegr. based on isozyme loci and found that there is refugium in Greece and even cryptic speciation occurring in Creta.

Van der Velde and Bilsma (2003) state that there is varied genetic differentiation among populations of five *Polytrichum* species studied in Europe based on allozymes and microsatellites. No genetic evidence was obtained for a step-wise recolonization of Europe from southern refugia after the latest glacial period for *P. commune* Hedw., *P. uliginosum* (Wallr.) Schriebl, *P. formosum* Hedw. and *P. piliferum* Hedw. Gene flow levels have apparently been sufficient to prevent genetic differentiation among populations caused by genetic drift, and to wipe out any genetic structure caused by the postglacial recolonization process. On the other hand, increased genetic differentiation of alpine *P. formosum* populations suggests that mountain ranges might restrict gene flow significantly among *Polytrichum* populations. In contrast to most examined *Polytrichum* species, *P. juniperinum* Hedw. showed high levels of genetic differentiation and a profound genetic structure. Assuming that gene flow is not more restricted in *P. juniperinum*, these findings suggest that this species has recolonized Europe after the latest glacial period from two different refugia, one possibly being the British Isles.

Recently, the availability of DNA-based methods, such as RAPDs and DNA sequencing, has led to renewed interest in the biogeography of bryophytes. Skotnicki *et al.* (1998) found high level of RAPD diversity in the moss *Bryum argenteum* Hedw.. Freitas and Brehm (2001) found two main clusters in an investigation of Macaronesian population of *Porella canariensis* (F. Weber) Underw. using RAPD:

one corresponding to Madeira and the other corresponding to Portugal and the other Macaronesian islands.

DNA data in phylogeography of bryophytes are very newly used and there are still very few studies. Firstly, some paleoaustral species (distributed in Australia, New Zealand and/or South America) have been considered (Frey *et al.*, 1999; Pfeiffer, 2000a, 2000b; Quandt *et al.*, 2001). All mentioned studies point out low level of differentiation of species treated in them. Some of these results were used to introduce the term stenoevolution, coined to characterize a very low genetic divergence accumulated over a long geological period in separate populations that are supposed to lack adaptations for long-distance dispersal.

In contrast to study mentioned above, McDaniel and Shaw (2003) studied three chloroplast DNA regions of *Pyrrhobryum mnioides* (Hook) Manuel and found that New and Old World populations formed mutually monophyletic clades. They point out the existence of Gondwanan vicariance due to sequence differentiation between South American and Australian populations.

Recently, non chloroplast region start to be suitable for bryophyte phylogeography research and up to now there are only few studies concerning bryophyte phylogeography based on nuclear ribosomal ITS region of genomic DNA. Chiang and Schaal (1999) introduce ITS2 region into moss phylogeography in ten populations of *Hylocomium splendens* in North America and concluded that there are at least three good defined haplotypes. Shaw *et al.* (2002, 2003b) and Werner *et al.* (2003) deals with ITS divergence among populations of several moss species in North America and North Africa/Europe. The distribution pattern of all these species would appear to be classic examples of so-called Madrean-Tethyan pattern, which is thought to reflect range fragmentation over at least 25 My (Axelrod, 1975). However, the minor but not negligible degree of sequence differentiation between intercontinental disjuncts led to this hypothesis being reject by the authors in favour

of more recent dispersal. Based on ITS variation Shaw (2000, 2001) expresses complex infraspecific phylogeographic and phylogenetic patterns and points out cryptospeciation within *Mielichhoferia elongata* (Hook.) Hornsch. and *M. mielichhoferiana* (Funck in Hook.) Loeske.

The concept of phylogeography was presented by Avise *et al.* (1987) and represented an important step in understanding of population genetics and systematics at species level. Phylogeographic analysis has predominantly been applied in animal systems because maternally inherited mitochondrial DNA of these organisms varies to a considerable degree and is not subject to recombination, making it an ideal object to study. In contrast, the sequence divergence of plant mitochondrial DNA, although evolving more rapidly, is still slowly evolving molecule (Dowling *et al.*, 1996). Nevertheless, recent years have seen a growing interest on the part of plant biologist in the application of phylogeographic methods and in many cases plant chloroplast DNA has been shown to vary sufficiently for phylogeographic studies to be carried out, although sites showing more variability would be desirable (e.g. ITS region; Schaal *et al.*, 1998), if the variability is not intemperate.

1.5. SPECIES CHOSEN FOR OUR INVESTIGATION

Long terrestrial history of mosses with almost no fossil record, where climatic oscillations occurred, their ranges which are bigger than those of vascular plants, but often scattered and not easy explained bring us to idea to lead molecular investigations in selected mosses with aim to get the picture of genetic diversity among populations and try to reconstruct their phylogeography, relictness vs. dispersal in Europe by comparing certain DNA sequences. For these purposes five moss species were chosen: *Campylopus oerstedianus* (Müll. Hall.) Mitt. , *Hilpertia velenovskyi* Schiffner, *Isothecium holtii* Kindb., *Rhytidium rugosum* Hedw. (Kindb.) and *Dichelyma capillaceum* (Dicks.) Myr.

1.5.1. *CAMPYLOPUS OERSTEDIANUS* (Fig. 4.-6.)

Campylopus oerstridanus was firstly described as *C. mildei* from South Tyrol, and was treated for a long time as endemic from the Alps. Lately, it was found in Pyrenees and North Greece (Chalkidiki), what give an idea of its tertiary origin. Afterwards, this species was found in Costa Rica, Jamaika and Georgia (Frahm, 1988; 1999). This inferred to the idea that this species of cyrcum thetian distribution is of high relict characteristics. Species was later found in some more Central European sites (France, Switzerland), and due to its sterility all over its range, it was good model for our moss relict case study.

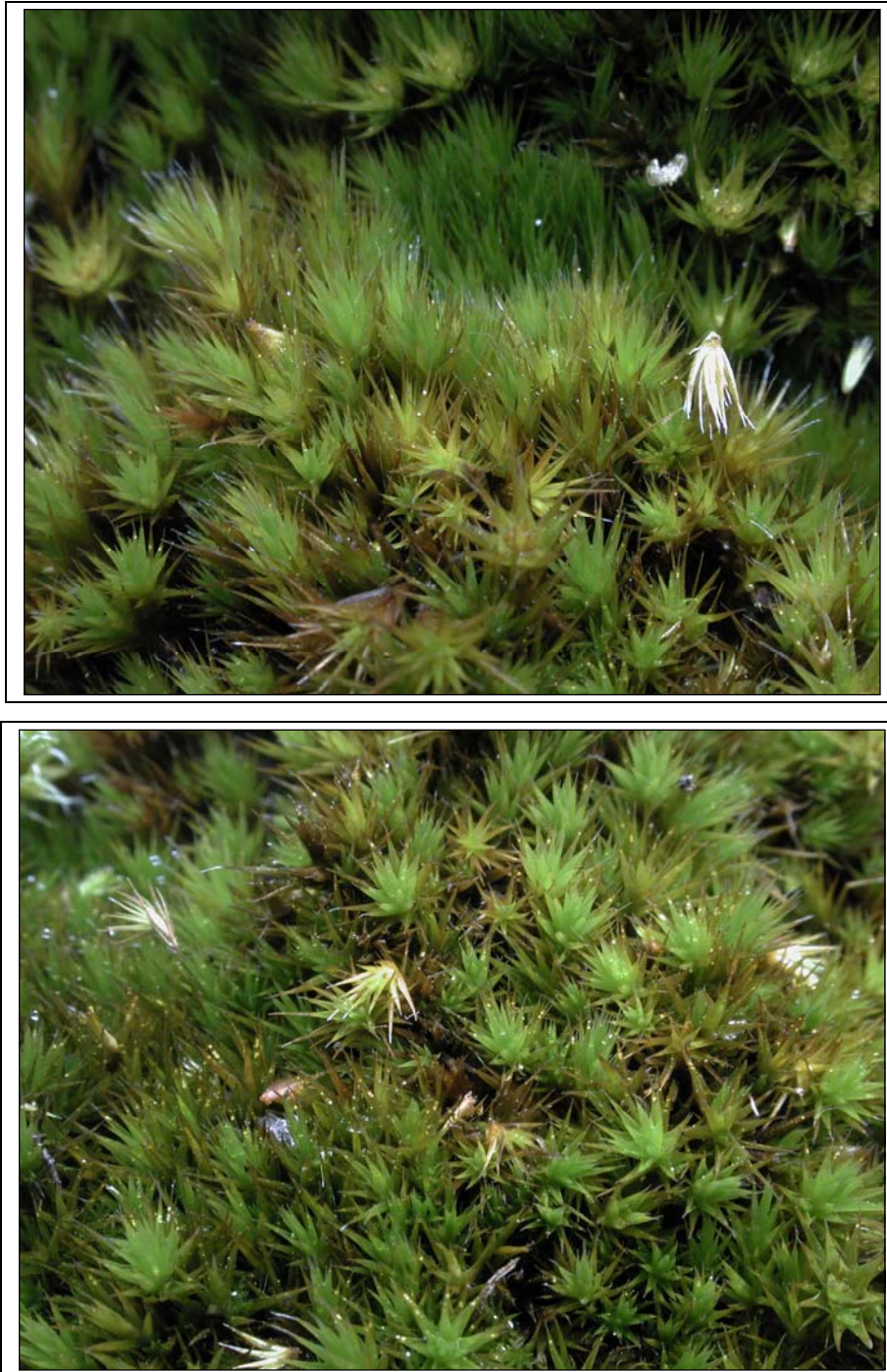

Fig. 4. and 5. Plants of *Campylopus oerstedianus*, with detached tips. (Photos J.-P. Frahm)

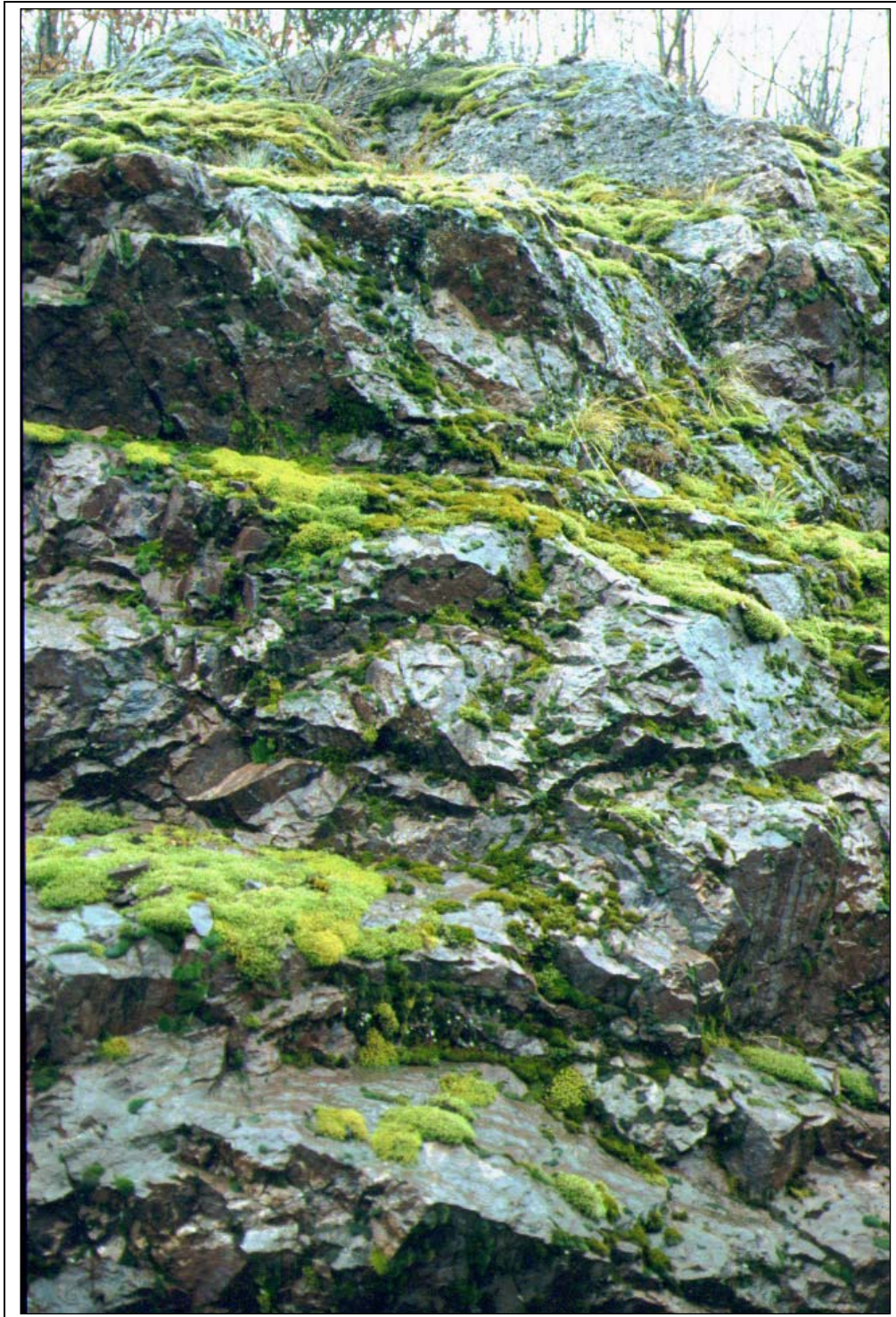

Fig. 6. Habitat of *Campylopus oerstedianus* in Vosges Mts., France (Photo J.-P. Frahm)

1.5.2. *HILPERTIA VELENOVSKYI* (Fig. 7.-9.)

Hilpertia velenovskyi is obligatory loess cliff growing species, with its main distribution in central and Eastern Europe. However, lately with its synonymization with *H. scotteri* from China (Tan and Zhao, 1997) and new records in Alaska and Canada its distribution is scattered and comprises Holarctic. Recently, it is discovered also in Western Germany (Frahm, 2000). Since it has very specific habitat demanding and is addicted especially to glacial relief forms, plus rarely seen with sporophyte, it is considered to be a good model for our investigations.

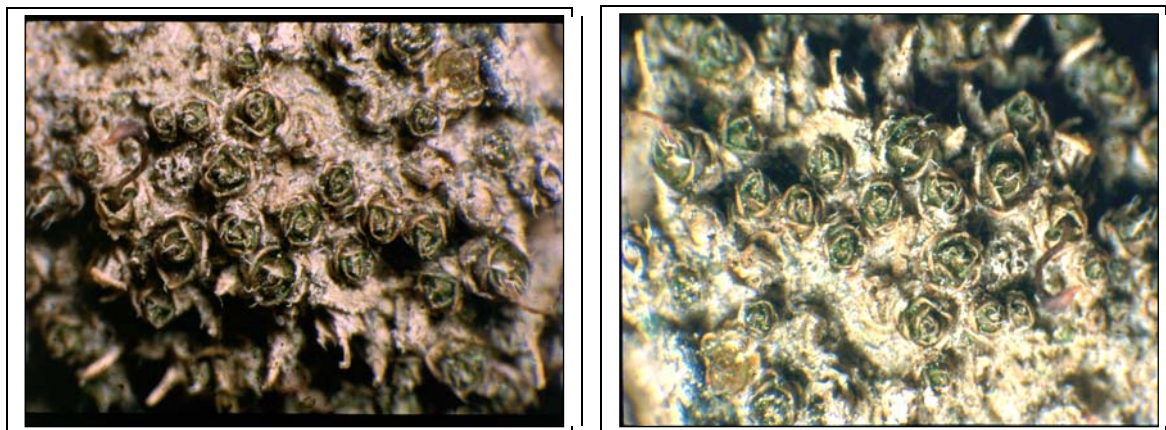

Fig. 7. and 8. Plants of *Hilpertia velenovskyi* (Photos J.-P. Frahm)



Fig. 9. World distribution map of *Hilpertia velenovskyi*, showed by black dots.

1.5.3. *ISOTHECIUM HOLTII* (Fig. 10.-13.)

Isothecium holtii has been regarded either as good species, dubious species, or as a variety of either *I. alopecuroides* or *I. myosuroides*. Its distribution range includes the British Isles, western France and western Norway, with disjunct occurrences in Central Europe and Turkey.

Its range, rarity, recently new records out of known western-European range and sterility make this species good model for our study.



10.



11.



12.



13.

Fig. 10.-12. Plants of *Isothecium holtii* (Photos J. –P. Frahm)

Fig. 13. Habitat of *Isothecium holtii*, Rurtal by Aachen, Germany (Photo J.-P. Frahm)

1.5.4. *RHYTIDIUM RUGOSUM* (Fig. 14.-15.)

Rhytidium rugosum is widespread pleurocarpous moss species in Northern Hemisphere. However, its range is very scattered. In the Central Europe it is characteristic for sunny, warm and open habitats (Frahm, 2005). It is present in the Alps till 2000m (Düll, 1994) and in southern Europe, but with significantly higher abundance in Scandinavia (Nyholm, 1954-1968). In North America it reaches the peaks up to 3500m and is generally present in tundra vegetation (Lawton, 1971). Its general distribution is of boreal type.

The species is over its range mainly sterile and extremely rarely seen with sporophytes. Eventhough, *R. rugosum* does not have any special kind of vegetative spreading mechanisms. So the origin and genetic diversity among its population is questionable. Are all population derived from one refugial which survived Ice Age or there have been more smaller refuge spaces and nunatcks and more than one migration events, due to the evidence of its range dynamics?



Fig. 14. and 15. Plants of *Rhytidium rugosum*, Altenahr, Rheinland-Pfalz, Germany (Photo M. Sabovljević).

1.5.5. *DICHELYMA CAPILLACEUM* (Fig. 16.-18.)

The dioecious moss *Dichelyma capillaceum* (Fontinalaceae) has a very scattered ampho-atlantic range, mainly represented in the North-Eastern part of North America and Scandinavia (Nyholm, 1960; Toivonen, 1972; Crum and Anderson, 1981; Ireland, 1989). In Europe, most of the populations (19) are situated in southern Sweden, but are decreasing (ECCB, 1995; Hylander 1998). Further on, a very few small populations are known from Finland, Poland and Karelia in Russia (Kotiranta et al., 1998). In Estonia, it cannot be refound and populations known from Denmark, Italy and all except one in France are assumed to be extinct (Allorge and Jovet-Ast, 1948; ECCB, 1995). No data on recent populations from Poland and Karelia are available. Each one population from Germany and from France seem to be still present. The records from the Netherlands, Greece and Sicily are reports from 1760, 1851 and 1888, respectively (Touw, 1989; Preston, 1984; Dia et al., 1987), but none of these has been verified. So the actual centres of distributions of this rare and endangered species are North-eastern North America and Northern Europe.

No data on reports of European fossil or subfossil finds of *D. capillaceum* has been found (e.g. Jovet-Ast, 1967; Dickson, 1973) and at least no Quaternary subfossils of this species exist from North America either (Miller, 1980; Janssens, 1983).

Dichelyma capillaceum is yellowish-brown to green, medium sized pleurocarpous aquatic moss growing in small tufts up to 10cm long. Leaves are erect-spreading, slightly falcato secund and lanceolate. Nerve is excurrent in long, aristate point about $\frac{1}{2}$ the length of the leaf. The capsules are extremely rare and immersed. The species is almost without exception sterile in Europe, and it is suspected to have lost its ability to produces capsules due to declining habitat quality and frequencies of male plants (Hedenäs et al., 1996). Currently spreading occurred asexually with the fragments of the young branches. No specialized vegetative dispersal units are known in *D. capillaceum*, but possibly plants can be dispersed vegetatively, either at

a limited locality by elongating stoloniferous shoots that are sometimes seen firmly attached to the substrate or, within the a water course by fragmentation (Toivonen, 1972). There is no evidence of long distance dispersal, and the main dispersal vector seems to be stream water.

It inhabits riparian habitats, growing on the tree bark and rocks.

In Europe, this species is treated as vulnerable and is included in Appendix I of the Bern Convention and in Annex 2 of the EC Habitats and Species Directive.

Dichelyma capillaceum has been found in Germany only once between Bonn and Cologne at the beginning of the 20th century (Brasch, 1923). The locality is ca. 1500 km air distance away from the main European range in Scandinavia (Sweden). Again, Feld (1958) cited the locality without confirming the existence of the populations and mentioned that there are two more literature data for the eastern Germany (Sagan and Westprußen), taken from Mönkemeyer (1927). The searches to find German populations failed over years and Düll (1980) states that the species is impossible to find due to change of landscape and finally considered it as extinct (Düll, 1994). The species was re-found in sterile stage again in 1997, more than seventy years after previous records (Frahm and Stapper, 1998). Even, the species is cited as exclusively sterile as it is mostly over all its present range in Europe, one herbarium specimen from 1923 bear sporophytes.

It is not clear whether the German population settled the present habitat by long distance dispersal originated from either North American or Scandinavian populations or was it there for a long time already. Also, considering that species was not seen for the decades with sporophytes across its range, and no propagules for long range spreading are known, the question of the relationship of German population with representatives in two present centers of its distribution is raised.



Fig. 16.-17. German population of *Dichelyma capillaceum* in 1997 (left; foto J.-P. Frahm) and 2005 (right, foto M. Sabovljevic).

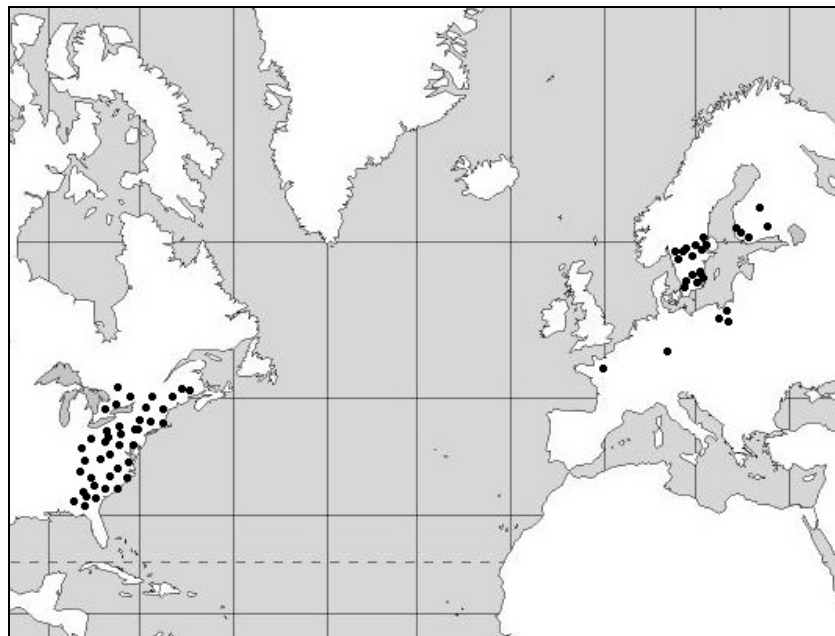

Fig. 18. World distribution of *Dichelyma capillaceum* (redrawn from Hedenäs *et al.*, 1996)

2.0. AIMS, MATERIAL AND METHODS

2.1. AIMS

The aims of the thesis presented here were to answer the following question:

Are disjunct bryophyte populations the remnants of relicts or results of long distance dispersal events?

2.2. MATERIAL PREPARATION

The fresh material of selected moss species populations was collected and deposited in herbarium BONN as voucher specimens. The moss patches were taken as much as possible to be one clone. Some moss material is generously sent by various colleges from Europe and Asia, as well as from curators of various herbaria. Those specimens were selected not to be more than ten years in dry state of herbarium collections.

Moss material is dry cleaned (always with gloves on hands), and then the green tips of mosses (as much as possible) have been taken out with the fire sterilized but cooled forceps, always from the same branches if possible (to avoid different clones in the same moss patches). The moss tips are transferred in clean sterilized Petri dish and rinsed with distilled water.

Petri dish is placed under the stereo microscope and then tip by tip is examined using sterilized forceps to take away impurity of various, under stereo microscope visible, particles, algae etc. Such a way cleaned moss tips were transferred to another sterile Petri dish. Sterile water was added and again was carefully examined to dirt. The tips were two more times rinsed with sterilized water, and then transferred to clean imbibe paper till dry. Afterwards, the dry tips were collected with sterilized forceps to dry clean and previously prepared envelopes with codes of specimens from the database and lived in the chamber with silica gel.

This way prepared material can be kept till few weeks before start of DNA extraction. Alternatively, clean moss tips can be transferred in 2.0 ml Eppendorfs or envelopes of Alu – folia with labels and deposited in -20°C till DNA extraction.

2.3. DNA EXTRACTION

(All dishes, plastic and instruments are previously autoclaved)

Previously autoclaved spatulas and forcepses sterilized trough the fire with ethanol. CTAB – buffer heat in water bad till 60°C. It is necessary approximately 800µl per sample. Add mercapto-ethanol (ME) to CTAB buffer (ratio 20µl ME/10 ml CTAB) and shortly keep in water bad at 60°C.

Way 1:

1. Add autoclaved send to squash dish.
2. Add sample from the eppendorfs or envelopes to squash dish.
3. Add 500 µl CTAB+ME to squash dish.
4. Macerate until the moss tips are completely squashed.
5. Collect the contents of the squash dish in 2.0 µl eppendorf.
6. Add 100 µl of CTAB+ME to collect remnants from the dish walls.
7. Collect the contents of the squash dish in 2.0 µl eppendorf.
8. Transfer the eppendorfs with CTAB+ME and squashed moss content to water bad at 60°C for 30 minutes and every 5 minutes strongly shake.
9. Add 200 µl CTAB+ME to squash dishes and repeat all from the step 4.
10. New content of squash dish add to previously.
11. Centrifuge 2 minutes at 14000 rpm at room temperature.
12. Collect the supernatant to 1.5 µl eppendorfs, and leave it at room temperature.

Way 2:

1. Transfer the prepared moss material to 2.0 µl eppendorfs.
2. Add 2 or 3 metal balls of 2 or 5 mm diameter (depending of moss material consistence)
3. Put the eppendorfs in the right position in the strong shaking machine and start it 2 to 8 minutes at 30 Hz (also depending of moss material consistence)
4. To dusted mosses in eppendorfs add 500 µl CTAB+ME

5. Transfer to the water bad at 60°C for 30 minutes and every 5 minutes strongly shake.
6. Centrifuge 2 minutes at 14000 rpm at room temperature.
7. Collect the supernatant to the 1.5 µl eppendorfs.
8. Add 300 µl CTAB+ME to the subnatant and put the eppendorfs in the right position in the strong shaking machine and start it 2 to 8 minutes at 30 Hz
9. Transfer to the water bad at 60°C for 30 minutes and every 5 minutes strongly shake
10. Centrifuge 2 minutes at 14000 rpm at room temperature.
11. Collect the supernatant and add to the previously one in the 1.5 µl eppendorfs

To the collected supernatant add chlorophorm in ratio 1:1 and shake it 5 minutes without interruption.

Afterwards, centrifuge 10 minutes at room temperature at 14000 rpm.

Upper clear phase transfer to new 1.5 µl eppendorf and add 0.8 isopropanol (100 %) of phase volume.

These eppendorfs should be at least 20 minutes at –20°C, but it is possible to leave it for a few days.

Cool the centrifuge till 4°C, and centrifuge the eppendorfs from the –20°C 30 minutes at 14000 rpm.

Get out the isopropanol form the eppendorfs taking care not to pick up the pellets.

Pellets wash up with 200 µl of 70% ethanol, centrifuge 1 minute at 14000 rpm afterwards getting out the ethanol leaving pellets within the eppendorf (two times).

Leave the pellets to dry at least 30 minutes.

Dry pellets dissolved in 50 µl of TE (or water).

Dissolving pellets can be kept all night in shaker, or in water bad at 30°C, or can be leaved for a few days at + 4°C.

2.4. POLYMERASE CHAIN REACTION PROTOCOLS (Tab. 2a, b. and 3a, b.)

Make master mix in one eppendorf. Than transfer 45µl of master mix to each eppendorf. Add 5µl of template (diluted extracted DNA 1:4) or alternatively 1.45 µl non-diluted extracted DNA.

The following pattern were used (Tab. 2a, b and 3a, b.):

Tables 2a and 2b. Polymerase Chain Reaction Protocol

2a. For double stranded PCR amplification of ITS/IGS regions of the nrDNA

µl of	50µl reaction	2(3)	4(5)	6(7)	8(9)	10(11)	12(13)
H ₂ O (ultraclean)	24.2	72.6	121.0	169.4	217.8	266.2	314.6
10X Taq Buffer (containing 15mM MgCl ₂)	5.0	15.0	25.0	35.0	45.0	55.0	65.0
25 mM MgCl ₂	1.5	4.5	7.5	10.5	13.5	16.5	19.5
Forward primer 20pmol/µl	2.0	6.0	10.0	14.0	18.0	22.0	26.0
Reverse primer 20pmol/µl	2.0	6.0	10.0	14.0	18.0	22.0	26.0
dNTP (each 1.25 mM)	10.0	30.0	50.0	70.0	90.0	110.0	130.0
Taq DNA polymerase (5units/µl)	0.3	0.9	1.5	2.1	2.7	3.3	3.9

2b. For double stranded PCR amplification of *trnL-F* regions of the plastid DNA

µl of	50µl reaction	2(3)	4(5)	6(7)	8(9)	10(11)	12(13)
H ₂ O (ultraclean)	23.7	71.1	121.0	169.4	217.8	266.2	314.6
10X Taq Buffer (containing 15mM MgCl ₂)	5.0	15.0	25.0	35.0	45.0	55.0	65.0
25 mM MgCl ₂	2.0	6.0	10.0	14.0	18.0	22.0	26.0
Forward primer 20pmol/µl	2.0	6.0	10.0	14.0	18.0	22.0	26.0
Reverse primer 20pmol/µl	2.0	6.0	10.0	14.0	18.0	22.0	26.0
dNTP (each 1.25 mM)	10.0	30.0	50.0	70.0	90.0	110.0	130.0
Taq DNA polymerase (5units/µl)	0.3	0.9	1.5	2.1	2.7	3.3	3.9

Tables 3a and 3b.

3a. The PCR Profile for amplification for the Internal Transcribed Spacer (ITS) region of the nuclear ribosomal DNA.

Step	Duration/Temperature	Cycle
Start DNA denaturation	5 min at 94°C	1
DNA denaturation	1 min at 94°C	35 x
Primer annealing	1 min at 48°C	
Extension	1 min at 72°C	
Ending extension	10 min at 72°C	
Cooling	4°C	

3b. The PCR Profile for amplification for the *trnL*-F region of the plastid DNA.

Step	Duration/Temperature	Cycle
Start DNA denaturation	2 min at 94°C	1
DNA denaturation	30 sec at 94°C	35 x
Primer annealing	30 sec at 60°C	
Extension	30 sec at 72°C	
Ending extension	1 min at 72°C	
Cooling	4°C	

2.5. PRIMERS (Tab. 4. and 5.)

Primers for amplifying and sequencing the ITS region (ITS4-bryo and ITS5-bryo; Tab. 4.) based upon the primers "ITS4" and "ITS5" respectively, designed and named by White *et al.*, were slightly modified with respect to bryophytes. The primers ITS-C and ITS-D were modified for this study (ITS-D_bryo and ITS-C_bryo) and used for amplification of ITS 1 and ITS 2 and for sequencing reactions. ITS 1 was amplified

with primers ITS5 –bryo (forward primer) and ITS-C bryo (reverse primer). ITS 2 was amplified with primers ITS-D bryo (forward primer) and ITS4-bryo (reverse primer).

Table 4.: Primer sequences used for amplification and sequencing of the ITS region. Underlined nucleotides represent changes with respect to the original primers of Blattner 1999.

Primer	Sequence	Data source
ITS-C bryo	GCA ATT CAC ACT ACG TAT CGC	Blattner 1999
ITS-D bryo	CTC TCA <u>G</u> CA ACG GAT ATC T <u>I</u> G	Blattner 1999
ITS4-bryo	TCC TCC GCT TAG TGA TAT GC	Stech 1999
ITS5-bryo	GGA AGG AGA AGT CGT AAC AAG G	Stech 1999

Sequencing reactions were performed with the reverse primer for either ITS 1 (ITS-C bryo) or ITS 2 (ITS4-bryo) or forward primer for either ITS 1 (ITS5-bryo) or ITS2 (ITS-D bryo).

The amplification of the *trnT*-L region (Taberlet et al., 1991) was carried out using the forward primer C and the reverse primer F (Tab. 5) slightly modified for bryophytes according to Meißner et al., (1998) and Sugiura et al., (2003).

Table 5.: Primer sequences used for amplification and sequencing of the *trnL*-F region.

Primer	Sequence	Data source
trnL-C bryo	CGA AAT <u>I</u> GG TAG ACG CT <u>G</u> CG	Meißner et al. 1998
trnL-C	CGA AAT CGG TAG ACG CTA CG	Taberlet et al. 1991
trnL-F bryo	ATT TGA ACT GGT GAC AC <u>G</u> AG	Sugiura et al. 2003
trnL-F	ATT TGA ACT GGT GAC ACA AG	Taberlet et al. 1991

2.6. AGAROSE GELS

1. **Test gel** is used to check up weather there is DNA after extraction or PCR products. It runs ca. 1 hour at 70 V.

Gel contains 0.9% of agarose in 120 ml of 1X TAE or 1X TBE. After gels solidify small gel chambers are filled with mix of 4µl loading buffer (6X), 2µl of concentrated extracted DNA and 1µl of gelstar (100X).

2. **Extraction gel** is used to extract PCR products. It runs 3 hours at 80 V.

Gel contains 1.2 % of agarose in 200 ml of 1X TAE or 1X TBE. After gel solidifies huge gel chambers are filled with mix of 5µl loading buffer (6X), 15µl of PCR product and 2µl of gelstar (100X).

3. **Quantity gel** is used after purification of extracted PCR products for check up the quantity of extracted and purified PCR products. Gel contains 1% agarose in 100 ml of 1X TAE or 1X TBE. It runs ca. 1 hour at 70 V. Small gel chambers are filled with mix of 5µl DNA (PCR products), 3 µl of loading buffer (6X) and 2 µl of gelstar (100X).

As a buffer in gel trays 1X TAE or 1X TBE were used.

Extraction

1. All PCR products of the same simple and same pair of primers united in the one tube.
2. To such a volume add 1/10 of volume of 5 M NaCl.
3. Add 2 volume of PCR products volume 100% ethanol

4. vortex
5. freeze 15-30 minutes or longer
6. cool the centrifuge at +4°C
7. centrifuge samples 10 minutes at 14 rpm at +4°C and afterwards discard supernatant
8. add 350 µl of 70 % ethanol
9. centrifuge 15 minutes at 14000 rpm at + 4°C and afterwards discard supernatant
10. dry pellets
11. rehydrate pellets in 15 µl H₂O_{dd} or 1X TE
12. load extraction gel with 15 µl of rehydrated pellets + 5 µl of loading buffer + 2 µl of gelstar, in every second gap
13. run the gel for 3-4 hours at 100 V.
14. For all extracted samples, measure one 1.5 ml tube
15. Cut the band and transfer it into labeled tube
16. Measure the full tube

Extracted bands deposited in tube can stay over the night at +4°C or proceed directly with Gel Extraction Kit Protocols (QIA Gen, Sigma or Nucleo Spin)

2.7. STOCK SOLUTIONS AND BUFFERS

1. 0.5 M EDTA; pH=8.0

Na ₂ EDTA	164,14g
H ₂ O _{dd}	1l

EDTA- tetrasodium salt has pH=14, so the pH should be adjust at 8.0 adding HCl (20%).

Na₂EDTA should be dissolved in ca. 800 ml of H₂O_{dd}, and after adjusting of pH filled with water till 1l all. It should be autoclaved.

2. 0.5 M NaCl

NaCl	29.2g
H ₂ O _{dd}	

29.2g of NaCl put in the glass and add till 100 ml H₂O_{dd}. Keep in room temperature.

3. 1x 7.5 M NH₄Ac

NH ₄ Ac	57.8g
H ₂ O _{dd}	

57.8g of NH₄Ac put in the glass and add till 100 ml H₂O_{dd}. Keep in + 4°C. No autoclavable.

4. 1x 3 M NaAc

NaAc	24.6g
H ₂ O _{dd}	

24.6g of NaAc put in the glass and add till 100 ml H₂O_{dd}. It should be autoclaved.

5. 1 M Tris, pH=8.0

Tris -HCl	121.14g
HCl (20%)	

121.14g of Tris put in the glass and add till 1l H₂O_{dd} adjusting pH=8.0. It should be autoclaved.

6. CTAB extraction buffer

5 M NaCl	28ml
1 Tris-HCl	10ml
0.5 M EDTA	4ml
PVP	1g
CTAB	2g

than add till 100 ml H₂O_{dd} adjusting at pH=8.0 with 20% HCl

7. 10x TE buffer (Tris-EDTA; stock)

1 M Tris-HCl	1ml
0.5 EDTA	20µl

than add till 100 ml H₂O_{dd} adjusting at pH=8.0 with 20% HCl. It should be autoclaved.

8. 10x TBE buffer (Tris Borat EDTA; stock)

Tris	108.0g
Boric acid	55.0g
0.5 M EDTA	40.0ml

than add till 1000 ml H₂O_{dd}. In Tris and boric acid add 800 ml water, add EDTA and adjust with 5 M NaOH at pH=8.56. H₂O_{dd} should be autoclaved.

9. 1x TBE is 10 time diluted 10x TBE, but should be check up if pH remains 8.56.

10. 20x TAE buffer (Tris Acetate EDTA; stock)

Tris	96.8g
Glacial acetic acid	22.84ml
0.5 m EDTA	40.0ml

Add tris in glacial acetic acid and ca. 800 ml H₂O_{dd}, than add EDTA and adjust pH at 8.0 with 0.5 M NaOH.

11. 1x TAE buffer is 20 time diluted 20x TAE, but should be check up if pH remains 8.0.

12. 6x loading buffer

Brom phenol blue	0.25mg (0.25%; w/v)
Xylencynol (optional)	0.25mg (0.25%; w/v)
Glycerine	30.0 ml (30%; w/v)
0.5 M EDTA	10 ml

Add H₂O_{dd} till 100 ml adjusting pH=8.0 (5 M NaOH). Keep at + 4°C.

13. dNTPs (each 1.25 mM)

dATP (100 mM)	12.5 µl
dGTP (100 mM)	12.5 µl
dTTP (100 mM)	12.5 µl
dCTP (100 mM)	12.5 µl

Add 950µl H₂O_{HPLC}.

14. Primers

Primers arrive as powder like stuff (sometimes invisible), usually in blue cup manufactory tubes. Carefully open tube, since it is possible that some powder is in the lid.

Primer should be dissolved in volume of H₂O_{HPLC} (ultraclean water) as indicated in report from manufacturer (“synthesis report”). That way stock of 100 pmol/μl (100 mM) is made.

Primers should be 20 pmol of working dilution for both PCR and sequencing.

2.8. ALIGNMENT

The sequences are aligned in the program manually, after preliminary aligned in ClastaX. The alignment was made manually so that the homologue positions are one under another in the Domix Alignment Editor (Hepperle 2002, 2003). All the sequences are used in 5'-3' direction.

2.9. CLADISTIC ANALYSIS

The sequences contained information can gives trees with application of various methods. Phylogenogram is based on the methods that can either nucleotide position comparison among sequences or complete sequences comparison reduced to data matrix that gives insight in the distance values (e.g. Sullivan and Joyce, 2005). All the analyses are made in winPAUP 4.0b1.0 program (Swofford 2001, 2002).

2.9.1. Maximum parsimony (MP)

The aim of MP method is to find the tree that represent the relationship among examined sequences which can be considered as the most probably due to the smallest steps needed to achieve this relationship (Farris, 1970), which is in

accordance with evolution postulate that the highest probability change in evolution comes with the shortest way to achieved the final characteristics. The method was at firstly used for morphological characteristics (Hennig, 1966) and afterwards developed in algorithm for nucleotide sequences (e.g. Fitch, 1971).

In this method the position of the DNA sequences nucleotide are compared with each other. Non-variable parts of sequences do not count in analysis and so do not affect topology within the tree. The variable nucleotides within sequences make two groups: parsimony-uninformative and parsimony-informative. Uninformative are treated within analysis just in try for substitution (try for Autapomorphy). The topology of tree branches are made base on informative positions, which are informative between at least two sequence substitutions (Synapomorphies).

There is more than one possibility to find shortest tree. In exact search the shortest trees are the best trees. This can be achieved by “exhaustive search”. For example, in the tree with three taxa, the program makes search based on sequence comparison for all possible position of the fourth taxon, than do the same for the fifth, and so on. When the 5 taxa are already in analysis, there are already 15 possible trees, and by 10 taxa there are 2 Milion alternatives for the shortest tree (Felsenstein 1985, 1988). So this method due to its time and resource consuming is usually used for less than 10 taxa.

The other possibility of exact search is the “branch and bound” method (Handy and Penny, 1982). In this method which is significantly quicker, the program run using taxon by taxon making tree if the next tree is longer than previous this one is abandoned and the algorithm goes another direction, to the upper limit which is made by user.

In heuristic search, just the shortest trees are always saved, and than the algorithm search the position of the next taxon within this shortest tree, and so on till the last

taxon analyzed. This method is quicker than previously two but not always so exact (Kitsching, 1992). That is why the “random” method is used in 1000 replicates, which newly ordinate taxa that bring us more reliable results (Kitching, 1992).

With aim to find the optimal tree, “tree rearrangement” algorithm is used, and using the option “tree bisection and reconnection (TBR)”, the tree will be cut into two parts, and than all possibility to combine it again will be searched (Swofford *et al.*, 1996). If the program find shorter tree than at beginning, the start tree should be excluded in further consideration. If the algorithm find more than one short trees, it produce one so-called “consensus tree”. However, only the branching with over 50% of appearance should be considered (50% majority rule consensus tree) or even more strictly just the branches which appears in all trees (strict consensus tree).

2.9.2. Maximum Likelihood (ML)

The base in calculating the trees in this method is the same like in Maximum Parsimony, but the distance values are included in calculations (Lewis, 1988).

To calculate with Maximum likelihood it takes longer than with Maximum Parsimony or Neighbor Joining methods, because after every tree it gets probability (likelihood) for achieved topology is searched. The higher probability of the tree achieved the evolution model is more reliable (Nei, 1996).

The probability that the determined nucleotide appear in determined place of sequence is calculated by Substitution model.

2.9.3. Neighbor-Joining (NJ)

This method is based in contrast to previous two on distance among sequences analyzed. The algorithm made distance matrix for each pair wise sequences and compared them. The similarity of the two taxa is counted just like relationship between them (phaenetic principle). The tree is made starting with the pair that are the less distant, joining the taxon which is with the next less distant from the previous

(nearest neighbor). After each new topology made, the algorithm check-up that the branch length remains as short as possible.

Many different parameters can be used in making distance matrix, or calculate substitution types. The mostly used parameter is uncorrected “p” distance, also used in further studies.

2.9.4. Bootstrap Analysis

Bootstrap test is used to validate the topology once obtained with previous algorithms. The algorithm weight Original matrix with the pseudo data it produced from original matrix and it delete isolated data (Felsenstein, 1985). Than it produce new consensus tree with 50% majority rules, which is statistical support and probability for the tree previously obtained.

2.9.5. The chose of the outgroup

With aim to get better and more reliable tree, outgroup taxa are used in calculation with our ingroup taxa (targeted and studied taxa). The outgroup taxa should not appear within the ingroup branches in tree topology. As ougroup, the best is to use taxa which are close but not to close to the ingroup taxa (sister taxa) and the taxa which are considered to be evolutionary older than taxa examined.

3.0. RESULTS

The results of this dissertation are presented in five separate papers:

- 3.1. Relict or long-distance dispersal? A phylogeography case study of the rare and endangered moss *Campylopus oerstedianus* (Müll. Hall.) Mitt. (Dicranaceae) in Europe (submitted)
- 3.2. The origin of the German populations of *Hilpertia velenovskyi* (Pottiaceae, Bryopsida): inferences from variation in the nuclear ITS region (in press)
- 3.3. Taxonomic value, systematic position and the origin of German populations of *Isothecium holtii* Kindb. based on molecular data (in press)
- 3.4. Genetic diversity and phylogeography of the moss *Rhytidium rugosum* (Hedw.) Kindb. (Hypnales) in Europe (submitted)
- 3.5. The origin of German population of *Dichelyma capillaceum* inferred by *trnL-F* plastid DNA sequences (submitted)

3.1. Paper 1:

Relict or long-distance dispersal? A phylogeography case study of the rare and endangered moss *Campylopus oerstedianus* (Müll. Hall.) Mitt. (Dicranaceae) in Europe (by Sabovljević, M and Frahm, J.-P., submitted)

Abstract

The Genetic diversity and phylogeography of the moss species *Campylopus oerstedianus* in Europe was studied, based on the ITS region of the nrDNA of nine selected European populations. Although this species is known only in sterile stage, it seems to be that long-distance dispersal and so gene flow among populations is present within Europe. The Greek population is genetically most distant from the western-european populations, which indicates a long lasting isolation. The populations from France and Switzerland root together and have supposedly a common origin. Within the French population, that from the Pyrenées is the most basal one and the populations in the Massif Central and the Vosges Mts. can be derived from the latter. This indicates a dispersal from the Mediterranean to the north some time ago, although the species is sterile, and the dispersal propagules and vectors are not obvious.

Keywords: moss, *Campylopus oerstedianus*, phylogeography, Internal Transcribed Spacer, genetic distance, conservation

Introduction

A Trans-continental disjunct range, a pattern rather rare among vascular plant, is present among many bryophytes. Widely allopatric bryophyte species with morphologically similar populations can be genetically similar due to limited evolutionary potential or frequent gene flow by long-distance dispersal. Alternatively, phenotypically similar and disjunct populations of bryophytes may be genetically different, a consequence of genetic isolation due to a lack of gene flow.

Problems of genetic divergence of morphologically homogenous bryophytes give interesting insights in phylogeography of bryophytes (Bischler and Boisselier-Dubayle 1997; Wyatt *et al.* 1997; Shaw and Allen 2000; Shaw 2001).

The moss genus *Campylopus* Brid. is assumed to be of Gondwanan origin (Frahm 1988). Of the approximately 150 species within this genus worldwide (Frahm 1999, 2001), few of them extend their range into Europe (*C. atrovirens* De Not., *C. brevipilus* Bruch & Schimp., *Campylopus flexuosus* (Hedw.) Brid., *C. fragilis* (Brid.) Bruch & Schimp., *C. introflexus* (Hedw.) Brid., *C. oerstedianus* (Müll. Hall.) Mitt. *C. pilifer* Brid., *C. pyriformis* (Schultz) Brid., *C. shawii* Wils., *C. schimperi* Milde, *C. gracilis* Mitt., *C. setifolius* Wils., *C. subulatus* Schimp. in Rabenh.).

The population present in the Northern Hemisphere are either regarded as relict of warmer climate periods or neophytes in the bryofloras of North America and Europe (Frahm 1984, 1988, 2001).

Plants of *Campylopus oerstedianus* (Müll. Hall.) Mitt. are 1-3 cm in height, in olive green tufts, lighter above and brownish below, evenly foliate, tomentose. The leaves are 4-5 mm, lanceolate, gradually narrowed into a subtubulose, straight, concolorous subula; alar cells are slightly differentiated, reddish or hyaline; basal laminal cells hyaline, rectangular; distal laminal cells thick-walled, subquadrate to short-rectangular or oblique; costa filling half of the leaf width, excurrent in a short, hyaline tip, which is longer in perichaetial leaves, in transverse section showing adaxial

hyalocysts and abaxial stereids in groups of 2 cells, abaxially ridged. Specialized asexual reproduction is not seen. Sporophytes are unknown. It grows in thin soil layer covered half-exposed rocks.

The rarest *Campylopus* species in Europe is *Campylopus oerstedianus*, which is known from only a dozen localities. It has been described from Europe as *C. mildei* Limpr. (Limpricht 1885-1903). Plants of *C. oerstedianus* resemble *C. pilifer* in habit, however, with shorter hairpoints. In shady habitats the hairpoints are sometimes lacking. The plants are microscopically distinguished from *C. pilifer* by the slightly different shape of the distal laminal cells and the transverse section of the costa, which lacks abaxial lamellae on the costa, and has smaller adaxial hyalocysts of about the diameter of the median deuter cells, and groups of abaxial stereids with only 2 instead of 4 stereid cells.

C. oerstedianus ranges from Costa Rica to Jamaica and North Carolina in the New World and occurs in Europe (Fig. 19) in France, Spain, Greece, Switzerland, and Italy (Frahm 1980, 1989, 2002; Dia 2000; Cros 2001). The distribution is very scattered and suggests a circum-Tethyan range (margins of the Caribbean and Mediterranean seas). In Europe it is considered to be a rare and endangered species (Sérgio *et al.* 1994; ECCB 1995).

The species occurs in South-Eastern Switzerland and Northern Italy (7 small populations very close to each other), in the Pyrenées with few populations in Spain and France, populations in North-Eastern France (Vosges Mts) and the Massif Central and with one population in Northern Chalkidiki (Greece) and Corse (France). Its European range can be considered as scattered subatlantic-supra-mediterranean. Recently, it was reported from Sicily (Dia 2000). The fact that all European populations are disjunct and widely separated from each other and the species is (worldwide) known only in sterile condition raises several questions:

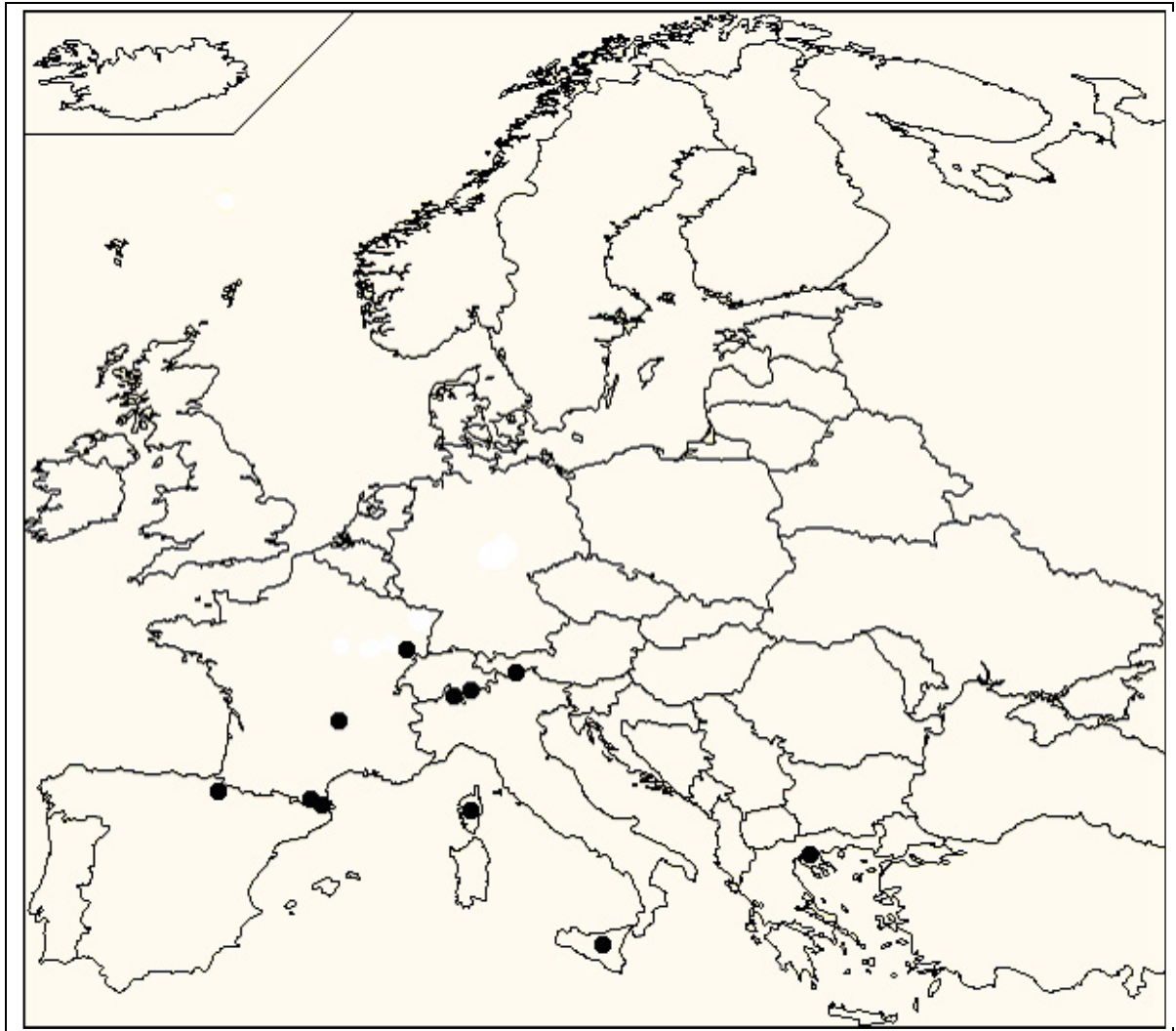

Fig. 19. Distribution of *Campylopus oerstedianus* in Europe (dots indicate all known localities)

- 1) Are the European populations relicts of a former continuous range or were they derived from other populations?
- 2) Are there significant genetic differences among the European populations?
- 3) Is there any gene flow among the disjunct European populations?

Materials and methods

Nine *C. oerstedianus* specimens from all over Europe were used for the molecular study. GenBank accession numbers and the details of collection are given in Table 6.

Table 6. The following specimens of *C. oerstedianus* were used for the molecular study:

Species	Origin	GenBank Accession No.
<i>C. oerstedianus</i>	Greece, Chalkidiki, Holomonadas, Sommergrüner Laubwald/Waldtal ca. 6 km oberhalb (s) Arnea. Silikatgestein, Granit, ca. 750 m. leg. R. Düll, 08.07.1993; (dupl. BONN s.n.)	AM049319
<i>C. oerstedianus</i>	Switzerland, Tessin (Ticino) – population 1, Morcote, Lugano, plentiful on acid rock by roadside of Parco Scherrer, alt. C. 300m. Leg. C.C. Townsend 10.09.2000 (dupl. BONN s.n.)	AM049326
<i>C. oerstedianus</i>	France, Vosges Mtns., - population 1, Haute-Saône, Tal der Beuletin NE Faucogney, leg. J-P. Frahm 31.10.1999, an Hornfelsklippen, Nr. 4479	AM049322
<i>C. oerstedianus</i>	France, Vosges Mts., - population 2, Dépt. Haute-Saône, Esmoulières, an der Strasse nach Faucogney, leg. J.-P. Frahm 12.09.2003, Strassenrand, Nr. V5180	AM049323
<i>C. oerstedianus</i>	France – Dept. Corèze, between Argentat and Beaulieu, vertical silicious rocks. Leg. Frahm 09.09.2002 (BONN s.n.)	AM049324
<i>C. oerstedianus</i>	France Dépt. Haut Loire, - leg. J.-P. Frahm 07.04.2002, (BONN, s.n.)	AM049325
<i>C. oerstedianus</i>	France, East Pyrenées, – population 1, Dépt Pyrenées Orientales, 1km unterhalb Grotte de Ponade W Banjuls sur Mer 80m, alt. Garrigue leg. Frahm 18.03.00 (BONN s.n.)	AM049320
<i>C. oerstedianus</i>	France, East Pyrenées, – population 2, Dépt Pyrenées Orientales, 1km unterhalb Grotte de Ponade W Banjuls sur Mer 100m, alt. Garrigue leg. Frahm 18.03.00 (BONN s.n.)	AM049321
<i>C. oerstedianus</i>	Switzerland, Tessin (Ticino) - population 2 NW Seite des Lago di Muzzano, SW Ligano, 360m An offen S exp Silikatfelsen im Laubwald leg. M Ahrens 08.10.1987 (BONN s.n.)	AM049327

Voucher specimens are deposited in the herbarium BONN.

As molecular marker, the Internal Transcribed Spacer (ITS) region of nrDNA was chosen because this region has revealed useful in the differentiation of taxa on a species or infraspecific level (Wendel *et al.* 1995; Baldwin and Sanderson 1998; Baldwin and Markos 1998; Ainouche and Bayer 1999; Andreasen and Baldwin 2001).

Prior to DNA extraction the plant material was thoroughly cleaned with distilled water. Success of cleaning was checked by examining the plants under a dissecting microscope. Remaining contaminants of algae, fungi, etc. were removed mechanically. DNA was isolated from silica dried fresh material mainly following the method Doyle and Doyle (1990). PCR amplification (Biometra TriBlock thermocycler, PTC-100 or PTC-200 MJ Research) were performed in 50 µl reactions containing 1.5U *Taq* DNA polymerase (Qiagen), 1mM dNTPs- Mix each 0.25 mM (Roth), 1 x buffer (Qiagen), 1.5-2.6Mm MgCl₂ (Qiagen) and 12.5 pmol of each amplification primer. PCR products were purified using the QIA quick purification kit (Qiagen). For cycle sequencing, half reactions were prepared using the ABI Prism Big Dye Terminator Cycle Sequencing Ready Reaction Kit with Amplitaq-DNA polymerase FS (Perkin-Elmer), applying a standard protocol for all reaction. Extension products were precipitated with 40µl 75% (v/v) isopropanol for 15 min at room temperature, centrifuged at 15.000rpm and washed two times with 250 µl of 75% (v/v) isopropanol. All products were sequenced using two primers in DNA Sequencing Facility, University of Maine, USA.

For amplifying and sequencing the ITS region the primers ITS4 and ITS5 (forward ITS 5bryo (5'-GGAAGGAGAAGTCGTAACAAGG-3' and reverse ITS 4bryo (5'-GCAATTCACACTACGTATCGC-3') originally designed by White *et al.* (1990). The entire ITS region was amplified using a protocol consisting of 5 min 94°C, 35 cycles (1 min 94°C, 1 min 48°C and 1 min 72°C) and 4 min 72°C extension time following completion. Cycle sequencing was performed using the following program: 25 cycles (30s 96°C, 15s 50°C and 4 min 60°C).

Calculations of molecular trees (Maximum Parsimony, Maximum Likelihood and Neighbor Joining) were performed with PAUP 4.0b10 (Swofford 2002). All characters were equally weighted and unordered. Multistate characters were interpreted as uncertain and gaps coded as missing data. Heuristic bootstrap searches were performed with 1000 replicates, 100 random addition per bootstrap replicate. The data were analysed using Maximum Parsimony, Maximum Likelihood and Neighbor Joining approaches on manual arranged alignments. Two accessions from the GenBank were used as outgroups: *Pilopogon guadalupensis* (AF444112) and *P. laevis* (AF444139).

Results

The combined length of the ITS1-5.8S rRNA-ITS2 region was 871 to 959 base pairs (bp). The shortest sequence was the one from Greek population (871 bp) and the longest of French - Haute Loire population (959 bp). The ITS1 region is variable with a few indels but not so much in range (from 400 bp in Greek population to 417 in Swiss-Tessin 1 population). The 5.8S rRNA gene had a constant length of 158 bp in all accessions. The ITS2 region (partial) was less variable in length in comparison with the ITS1 region.

The alignment had a total length of 1189 bases.

Of the aligned sequences, 1128 positions were constant, 39 characters were variable and parsimony uninformative and 27 were parsimony informative. Gaps were excluded from further analysis.

Discussion and Conclusion

The Maximum parsimony tree (Fig. 20) shows similar grouping pattern of that one shown in neighbour joining tree.

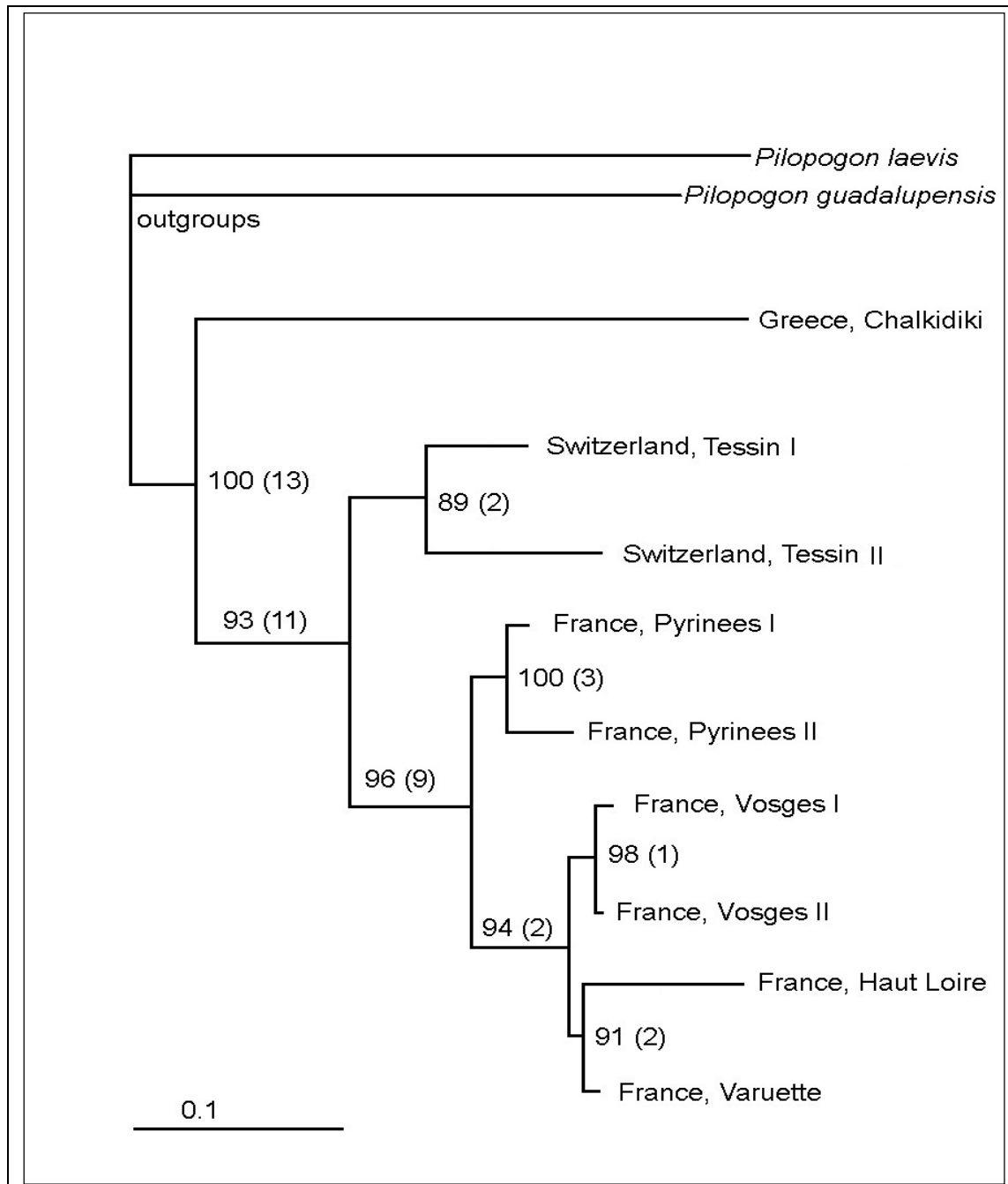

Fig. 20. Strict consensus tree of 1020 most parsimonious trees inferred from heuristic search of ITS sequences of *Campylopus oerstedianus* in Europe, with *Pilopogon* as outgroup representative, shows the phylogeographic relationships of selected European populations of *Campylopus oerstedianus*. Bootstrap values >50% and substitutions in brackets are indicated in ramification points.

Our molecular data support the idea that there is no genetic exchange among populations of *C. oerstedianus* in Europe.

The population in Northern Greece forms a separate clade, which implicates a long period of genetical isolation from the rest of the European populations.

The populations in the Southern Alps are connected with the western European populations but form a separate branch.

A possible explanation could be that all European populations formed once a continuous range, of which only local populations remained. Due to the sterility of the species, the populations remained separated. In this case, the genetic distances between the populations should be all the same. However, the fact that the French populations from the Massif Central and the Vosges Mts. root together indicates a phylogeographic relationship. Therefore it could be possible that these populations are derived from the plants in the Pyrenées and reached the Massif Central and the Vosges Mts. by long distance dispersal. Due to the sterility of the species, vegetative propagation must be taken into account, which by our observation can happen in this species by means of detached stem and leaf tips. This would reveal the potential of long distance dispersal by relatively large diasporas. It is supported by the fact that the populations in Central and North Eastern France are along the route of the prevailing SW-winds. Unfortunately we have no evidence for a determination of the time, when this dispersal happened. If we assume that the separation of the Swiss and French populations happened as a result of the last Ice Age, the dispersal to the North took place in the postglacial period, perhaps during the postglacial climatic optimum 8000 yrs. b.p. It could also be that the separation of the populations in the Pyrenées and the Southern Alps happened already earlier. In this case the spreading to Central and north-eastern France could also have happened earlier, perhaps even before the last Ice Age.

The possibility of a dispersal from the Pyrenées could be considered as most appropriate explanation for the phylogeography of *C. oerstedianus* in Europe since there are examples that long-distance dispersal in bryophytes are present where unexpected by vehicle of wind, storms, water flows and other means (Muñoz *et al.* 2004). Species with highly disjunctive distributions have generated controversy, however, because of long-distance migration is thought to be rare (Nathan 2001). Several studies suggest that long-distance dispersal of spore may be more common than previously appreciated (James *et al.* 2001; Skotnicki *et al.* 2001; McDaniel and Shaw 2003). However, empirical estimates of central parameters, such as rates of migration and colonization are still lacking (Husband and Barrett 1996). In *Campylopus* case, some atypical spreading mean like detached leaf tips or part of gametophores seem to be the most probable propagules for dispersal. Although the predominant means of long-distance dispersal is presumably accomplished by spores (Mogensen 1981; Bremer and Ott 1990; Miles and Longton 1992), some authors suggest gametophyte fragments (Miller and Ambrose 1976; During 1997; McDaniel and Miller 2000) or specialized asexual reproductive structure (Kimmerer 1994) to be responsible for long-distance dispersal in some smaller scale.

According to our molecular data, it can be considered the oldest populations are those in the Pyrenées and in northern Greece. The “p” distance analyses of selected population support the trees. The Greek population has the lowest similarity to all the others (73.2-79.2%), while the greatest similarity showed to be between two Pyrenées populations (91.8%) and two Vosges populations (93.6%). GC content in examined sequences is stabile (48.16-48.91%).

The conservation status of *C. oerstedianus* is uncertain in Europe. The biology of this species reveals to be unknown. Its IUCN protection status in European level should be considered in endangered (EN). However, inferred from molecular data obtained and some personal observation of French populations, no special protection measures are proposed considering that the populations are isolated and very small,

but however with existing but not determined spreading potential. The Greek population is of especial conservation interest due to its genetic distinctness from all other European populations. So far, passive conservation measures (e.g. bryophyte microreserves), and active monitoring if known populations increase, decrease or stay stable are considered to be enough until new biology investigation insights of this species are present (e.g. sexual structure of population, way and means of spreading).

3.2. Paper 2:

The origin of the German populations of *Hilpertia velenovskyi* (Pottiaceae, Bryopsida): inferences from variation in the nuclear ITS region (by Sabovljević, M., Frahm, J.-P. and Schaumann, F., *in press*, Cryptogamie Bryologie)

Abstract - *Hilpertia velenovskyi* is a continental-subarctic moss species, with a range from Ellesmeere Island over Canada, Siberia, Mongolia to China and with plenty records in Eastern and South-Eastern Europe. The species is an element of cold loess steppes. Recently, *Hilpertia velenovskyi* was recorded as new from Eastern Germany in Saxony and in Western Germany in Rheinhessen. To clarify, whether the German populations are a result of recent spore dispersal or perhaps relicts from the last Ice Age, a molecular analysis of the nuclear ITS region has been undertaken. The results show a clear separation of the population from Rheinhessen from the other investigated populations, which either indicate a long isolation possibly since the last Ice Age or a recent spore long-distance dispersal. The population from Saxony clusters with populations from Hungary and Serbia and is thus part of a Central-European group.

Zusammenfassung - *Hilpertia velenovskyi* ist eine kontinental-subarktische Moosart, deren Areal von Ellesmeere Island über Kanada, Sibirien in die Mongolei und nach China reicht und die Vorkommen im östlichen und südöstlichen Mitteleuropa hat. Sie ist eine Art der Kältesteppen auf Löß. Die westlichsten Vorkommen liegen in Sachsen in Ostdeutschland und Rheinhessen in Westdeutschland. Um zu klären, ob die rheinhessische, disjunkte Population von *Hilpertia* durch eine rezente Neuansiedlung über Sporenfernverbreitung stammt, oder aber autochton ist und dort eventuell schon seit der Eiszeit überdauert hat, wurde eine molekulare Untersuchung vorgenommen. Dabei wurden die genetischen Distanzen zwischen Populationen von *Hilpertia velenovskyi* aus Rheinhessen, Ungarn, Serbien und Zentralasien an Hand von Sequenzen der intern transkribierten Spacer 1 und 2 (ITS1/2 der nrDNA) bestimmt. Es zeigt sich, dass die Population aus Rheinhessen von den übrigen europäischen Populationen verschieden ist, was entweder bedeutet, dass diese Population seit langer Zeit, vermutlich seit der letzten Eiszeit, keinen Genaustausch mit den übrigen Vorkommen in Mitteleuropa hat und daher als Glazialrelikt zu werten ist. Eine andere Möglichkeit ist, dass diese Population durch Sporenausbreitung aus einem anderen Teil der Erde hierher gelangt ist. Die Population aus Sachsen clustert mit den übrigen Populationen aus Mitteleuropa und ist Teil der dieser Gruppe.

Introduction

Many bryophyte species show transcontinental disjunct ranges, a pattern that is rather rare among vascular plants. Morphologically similar bryophyte populations that are widely allopatric can be genetically similar, as a result of either limited evolutionary potential or frequent gene flow by long-distance dispersal. Alternatively, phenotypically similar and disjunct populations of bryophytes may be genetically differentiated, a consequence of genetic isolation due to a lack of gene flow. Problems of genetic divergence of morphologically homogenous bryophytes give interesting insights in phylogeography of bryophytes (Bischler and Boisselier-Dubayle, 1997; Wyatt *et al*, 1997; Shaw and Allen, 2000; Shaw, 2001). One of the bryophyte examples with very scattered range is *Hilpertia velenovskyi* (Schiffn.) Zand.

Hilpertia is a monospecific genus. It is based on material collected in the vicinity of Prague in the Czech Republic and described by Schiffner in 1893 as *Tortula velenovskyi* Schiffner. Later Zander (1989) give the genus *Hilpertia*, based on the strongly recurved laminal margins forming a hollow tube of thin-walled and papillose cells. The species is characteristic of cold steppe habitats. The type locality remained for a long time the only known locality for this species. Some fifty years later, Boros (1944) found *H. velenovskyi* in North-Eastern Hungary. Subsequently Podpera (1954) recorded it from Serbia, Pilous (1958) from the Czech Republic and Waclawska (1958) and Kuc (1960) from Poland. Later, Pócs (1999) added many new localities for Hungary and neighbouring regions. Müller (2000) reported this species as new for Germany based on a collection from the vicinity of Dresden (Eastern Germany), and Frahm (2000) confirmed the presence of this species in Germany based on a collection from another loess cliff from Rheinhessen (Western Germany). The records by Dresden in Saxony is close to known localities of *Hilpertia velenovskyi* in Czech Republic, but the one in Rheinhessen is the westernmost locality in Europe and quite far away from any other continental population.

Firstly, it has been thought that *Hilpertia* (*Tortula*) *velenovskiyi* is European endemic species. However, another *Hilpertia* species (*Hilpertia scotteri* (R. H. Zander and Steere) R. H. Zander) was described from the Northwest Territories of Canada as *Tortula scotteri* R. H. Zander & Steere (Zander and Steere, 1978). B. C. Tan and J. Zhao (1997) treat *H. scotteri* is a synonym of *H. velenovskiyi*, which extend its range over Northern Hemisphere but make it even more scattered (Fig. 9.). During the last few decades, many new sites in the Northern Hemisphere were recorded (Bai 1987, Tung 1963, Sibiria: Ignatov and Afonina, 1992, China: Tan and Zhao, 1997, North-Canada: Zander, 1989, dry areas of British Columbia: McIntosh, 1989, and Ellesmeere Island: Mogensen and Zander, 1999).

Hilpertia velenovskiyi is a continental-subarctic moss species, with a range from Ellesmeere Island over Canada, Siberia, Mongolia to China and with plenty records in Eastern and South-Eastern Europe. The species is an element of cold loess steppes.

The habitat of *Hilpertia* in Europe on dry and sunny loess cliffs, as well as the accompanying bryophyte species (species of *Aloina*, *Pterygoneuron*, *Crossidium* pp.) suggest a xerothermic species. For a map of the complete Holarctic distribution see Müller (2000), which suggests a rather subarctic – continental range.

The westernmost European populations are in Germany (Rheinhessen) and this raises the question about the origin of these populations. The record near Dresden is not far from the localities in Czech Republic, whereas the record from Rheinhessen is more than 500 km disjunct from the central and eastern European populations. There are principally two possibilities: First, the population in Rheinhessen is a result of a relatively recent dispersal from the population in Central and Southeast Europe, or long-distance dispersal from some extra European population. Secondly, we may also consider a long lasting separation of the population, which may even go back to

the last glaciation, when *Hilpertia* could have been indigenous in the former loess steppe in Rheinhessen.

The possibility that species could be overlooked is excluded since loess cliffs are small and ones of the best investigated habitats due to its extremely interesting cryptogamic flora.

To clarify the origin of *Hilpertia* in Germany and to infer relationships of selected populations of *Hilpertia velenovskyi*, a molecular study based on sequences of the internal transcribed spacer 1 and 2 was undertaken. Since *H. velenovskyi* is threatened species listed in European Red Data Book (ECCB, 1995), the understanding of its genetic diversity within the species is essential to develop strategies of collection, conservation and germplasm - formation. Genetic variation within a taxon is thought to be crucial for the long-term survival and continued evolution of populations or species (Franklin, 1980; Beardmore, 1983; Frankel, 1983; Huenneke, 1991). Thus, an accurate estimate of the level and distribution of genetic diversity of threatened and endangered species is an important element in proper conservation (Hamrick *et al.*, 1991; Shaal *et al.*, 1991; Chalmers *et al.*, 1992; Cardoso *et al.*, 1998; Kim *et al.*, 2005) However, due to status of species and scarcity of herbarium material, the data presented in this study should be considered as preliminary ones, until the implications for conservation rely on an extensive sampling of the populations.

Material and Methods

Hilpertia velenovskyi is protected by law in many countries, because of its rarity and vulnerability (e.g. Rajczy, 1990; Ochyra, 1992; Kučera and Váňa, 2003; Sabovljević *et al.*, 2004). Only six samples were available or suitable based on age and size of the collection, for our study:

1. Hungary, Tolna County, Mezöföld, Dunakömlöd (Paks). On 6-20 m high, N exposed loess cliffs at the N end of Sánc-H. with rich cryptogamich vegetation at 110-130 m alt. 46°39.3'N, 18°52'E, leg. S. & T. Pócs, G. Kis & A. Szabó.
2. Germany, Saxony, Meissen NW:Elbhänge an der Karpfenschänke, südexponierte Lösswände, leg. F. Müller.
3. China, Provinz Gansu, 40 km NW Lanzhou, 1820 m, Mergelhänge, 36°18.3'N, 103°38.5'E leg. B.Tan.
4. Hungary, Tokaj, Donath, Nagykopasz area, 160-200 m, loess cliff, leg. H. Kürschner
5. Germany, Rheinland-Pfalz, Rheinhessen Kr. Alzey, Naturschutzgebiet Steinkaute bei Dorn-Dürkheim, leg. A. Oesau.
6. Serbia, Vojvodina, Bačka, Titel plateau, Mošorin, loess cliff, leg. M. Sabovljević.

The Internal Transcribed Spacer 1 and 2 (ITS1/2) were used as molecular markers to infer the infraspecific variability.

The DNA extraction and PCR protocols follow Stech and Frahm (2001) and Quandt *et al.* (2004b). Alignment and tree formation followed the protocol by Borsch *et al.* (2003), using Align and PAUP4.0 (Hepperle, 2002; Swofford, 2001). For the determination of genetic differences, a comparison of nuclear ITS sequences based on uncorrected "p" distance was performed using the Neighbour joining - Methode (Saitou and Nei, 1987). Gaps were treated as missing data.

Results and Discussion

Nucleotide sequences were obtained for all six samples and deposited in EMBL Nucleotide Sequence Database with the accession numbers AJ973246, AJ973247, AJ973248, AJ973249, AJ973250 and AJ973251. A comparison of ITS sequences based on uncorrected "p"-distances suggests that the variation in sequences is not

partitioned geographically, and hence that geographic origin is a poor predictor of genetic identity between two populations of *H. velenovsky*

The length of ITS varies between 760 to 831bp. Chinese population has slightly more indels compared to European. The percent of GC content is equilibrated (53.21-54.63 %). Such a high GC content for ITS in *Hilpertia* can be explained by its extremely xerophytic character. A higher GC content may result from adaptation to warm and arid habitats (in animals: Bernardi *et al.*, 1988 and in plants: Salinas *et al.*, 1988; Jobst *et al.*, 1998; Torres *et al.*, 1990; Jarret and Newman, 2000).

The alignment had a total length of 854 bp. The ITS1 region was highly variable with multiple indels, while ITS2 was less variable. The 5.8S rRNA gene had a constant length of 162 bp. The length variation observed in ITS was primarily attributable to the occurrence of a short (GC)_n, (GCC)_n and (CT)_n oligo-microsatellite in ITS1 and (AC)_n in ITS2.

The unrooted neighbor-joining tree for selected populations of *Hilpertia* (Fig. 21.) shows that the Rheinhessen population from Western Germany is quite distinct genetically with the population Eastern Germany, Hungary or Serbia. The rather strong genetic isolation of the population from Western Germany (its ITS has 2 substitutions and 21 indels compared to other European populations) can be explained by a long period without gene exchange. This could be the case in a relict population of the last Ice Age, 13.000 years ago. It has to be considered, that *Hilpertia* could have been part of the flora in Central Europe during the last Ice Age. At that time, similar habitats were provided for the species as nowadays in Siberia or Ellesmere Island. Furthermore, loess was deposited in that time and loess cliffs persisted since that time, providing a constant habitat for bryophytes over the time.

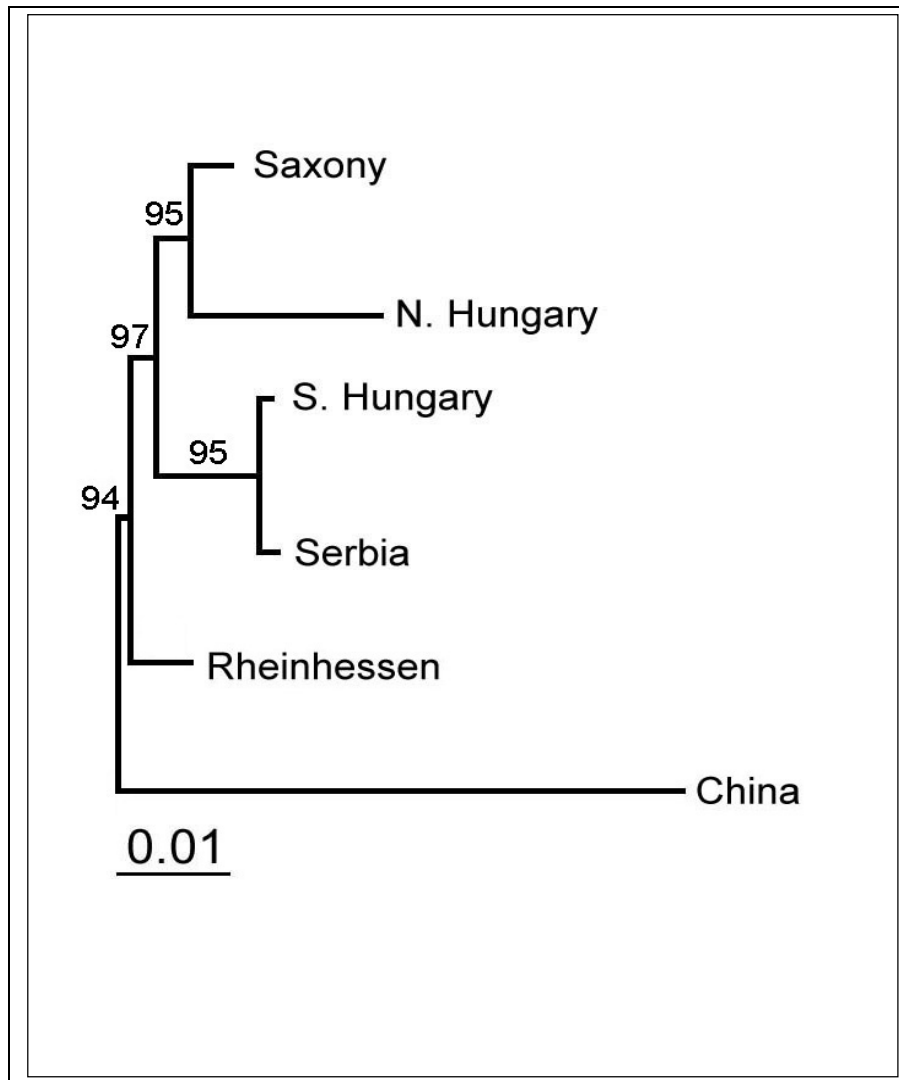

Fig. 21. The unrooted NJ tree for selected population of *Hilpertia velenovskyi* inferred by ITS nr DNA region. Bar scale indicates the inferred number of nucleotide substitutions.

Also, the presence of *H. velenovskyi* in Rheinessen, can be explained by long-distance dispersal from somewhere inside or outside Europe. According to the tree and branch length of Chinese population (Fig. 21.), Rheinessen population is not related to the latter. The latter hypothesis would be supported by the fact that

Hilpertia is known in Rheinhessen from only one locality and only recently discovered. On the other hand, long distance dispersal seems unlikely, since the next populations are in the Caucasus, Mongolia and Siberia, thus quite distant and situated against the prevailing wind system. However, this possibility should not be completely excluded since there are examples that long-distance dispersal in bryophytes are present where unexpected by vehicle of wind, storms, water flows and other means (Muñoz *et al.*, 2004). Species with highly disjunct distributions have generated controversy, however, because of long-distance migration is thought to be rare (Nathan, 2001). Several studies suggest that long-distance dispersal of spore may be more common than previously appreciated (James *et al.*, 2001; Skotnicki *et al.*, 2001; McDaniel and Shaw, 2003). However, empirical estimates of central parameters, such as rates of migration and colonization are still lacking (Husband and Barrett, 1996). In *Hilpertia* case, spores 10–12 µm in diameter and finely papillose, seems to be the most probable propagules for dispersal. Although the predominant means of dispersal on a local scale may be gametophyte fragments (Miller and Ambrose, 1976; During, 1997; McDaniel and Miller, 2000) or specialized asexual reproductive structure (Kimmerer, 1994), most long-distance dispersal is presumably accomplished by spores (Mogensen, 1981; Bremer and Ott, 1990; Miles and Longton, 1992). Consistent with some spores travelling long-distances, van Zanten (1978) found a strong positive correlation between spore longevity and size of distribution area. Moreover, the spore germination studies of van Zanten (1978) show that species with broad distribution often have spores tolerant of long storage and temperature extremes. The correlation between distributional area and spore tolerance may be underlain by additional habitat correlates such as substrate, which is the case with *H. velenovskyi* that is strictly restricted to specific habitats of loess cliffs (e.g. Pócs, 1999; Pócs *et al.*, 2002; Pócs *et al.*, 2004; Kürschner and Wagner, 2005)

A low rate variability of genetic data for *Bryum argenteum* Hedw. and *Ceratodon purpureus* (Hedw.) Brid. reveal large scale population structure, suggesting frequent

long-distance dispersal in these species (Miller and McDaniel, 2004). It is rather to believe that long-distance spreading in Rheinhessen from some other population occurred than that crypto-speciation started. Uit de Weerd *et al.* (2005) gives molecular evidence in passive long-distance dispersal of some Greek land snail, explaining it by birds and by humans accidentally. Since, similar fauna and flora inhabit loess cliffs it can be expected such passive long-distance dispersal by some highly mobile organisms.

All other European populations are more or less related. The population tested from Vojvodina (Serbia) shows great similarity with south Hungarian population, while the north Hungarian population clusters with the population from East Germany. Two German populations are clearly genetically distinct and of different origin.

Acknowledgements. We would like to thank Albert Oesau, Harald Kürschner, Frank Müller and Benito Tan for providing the samples for molecular research. We acknowledge the anonymous referees and Bernard Goffinet for valuable comments to manuscript.

3.3. Paper 3:

Taxonomic value, systematic position and the origin of German populations of *Isoetecium holtii* Kindb. based on molecular data (by Sabovljević, M., Frahm, J.-P. and Herbiniaux, U., *in press*, Lindbergia)

Abstract

Isoetecium holtii has been regarded either as good species, dubious species, or as a variety of either *I. alopecuroides* or *I. myosuroides*. Its distribution range includes the British Isles, western France and western Norway, with disjunct occurrences in Central Europe and Turkey. A molecular study was designed to clarify the taxonomic position of this taxon as well as to assess whether the disjunct populations in Germany are a result of recent migration or whether they are relicts of a wider distribution in more humid climatic periods. The analysis of nuclear ribosomal DNA sequences (internal transcribed spacer [ITS] 1/2) revealed that *Isoetecium holtii* is a good species, and that it is closer related to *I. myosuroides* than to *I. alopecuroides*. The disjunct populations in Germany are heterogenous. Two cluster with different populations in Western Europe, indicating independent dispersal events, whereas another is genetically isolated, indicating a long separation and a relict. The populations in Brittany and the Massif Central are genetically related but rooted with the populations from Britain and Ireland and indicating that they are relicts of a former continuous range.

Introduction

Isothecium holtii Kindb. was first collected by Holt in 1885 in Wales and named by him as *I. myosuroides* Brid. var. *rivulare*. The name was published by Limpricht in 1895, but raised to the rank of a species in the same year by Kindberg, who introduced the name *I. holtii*. In 1897, Paris listed the var. *rivulare* under *I. myurum*. Thus the taxonomic position of this taxon remained doubtful. Limpricht (1896) apparently regarded *I. myosuroides* var. *rivulare* as a modification, when he wrote that shorter leaf tips and vermicular foliation are typically caused by the influence of water. Later, Loeske collected this moss in the Ilse valley of the Harz Mountains and distributed specimens in 1902 under the name *Isothecium vallis-ilsae*. In his "Moosflora des Harzes", however (Loeske 1903), he reduced it to a variety of *I. myurum*, although he states that this is an "very excellent form" (sehr ausgezeichnete Form) and that he has seen no transitions to *I. myurum*. Also Mönkemeyer (1927) lists this species as variety of *I. myosuroides*. At that time, he cites only the localities in Wales and the Harz Mountains. Interestingly, *I. holtii* was placed by some authors to *I. myosuroides*, and by others to *I. myurum* (*alopecuroides*). Nyholm (1954 ff.) lists this taxon as *I. myosuroides* var. *rivulare* with occurrence in the British Isles, westernmost Norway and the Harz. In contrast, Smith (1978) accepts *I. holtii* as a species, but restricts this by the comment, that "the specific status of this plant is doubtful, as intermediates between it and *I. myosuroides* are said to occur." As distribution, he indicates the British Isles and again Norway and Harz.

In the past decades, *Isothecium holtii* has been found also in France in Finistère (De Zuttere *et al.* 1998, Frahm unpubl.), Côtes d'Armor, Cantal (De Zuttere pers. comm.), the Massif Central (Frahm unpubl.) and the Vosges (De Zuttere and Sotiaux 1985), in Luxemburg (Werner 1993), in Germany in the Eifel Mountains in (De Zuttere 1984 in Düll *et al.* 1996, Frahm 2003) and in the northern Black Forest (Nebel & Philippi 2001) and in Turkey (Uyar and Ören 2005). In the Black Forest, two records are from 1921, the others from between 1985 and 1995. These new records from Central

Europe as well as from Turkey would indicate a recent migration of the species, was it not for the old record from 1902 from the Harz and the two old collections from the Black Forest, suggesting rather that this species has been overlooked.

Several bryophyte species are endemic to Europe with an oceanic distribution and scattered disjunct occurrences in Central Europe. Examples are *Platyhypnidium lusitanicum* (Schimp.) Ochyra & Bednarek-Ochyra, *Oxystegus hibernicus* (Mitt.) Hilp., *Hypnum resupinatum* Tayl., *Isothecium holtii*, *Sematophyllum demissum* (Wils.) Mitt, *S. micans* (Mitt.) Braithw., *Lepidozia cupressina* (Sw.) Lindenb., *Frullania microphylla* (Gottsche) Pearson, *Lejeunea lamacerina* (Steph.) Schiffn., *Fissidens rivularis* (Spruce) Bruch & Schimp. or *F. monguillonii* Thér., which have a more or less continuous distribution in Western Europe but which also found in isolated populations in Central Europe. We don't know at which time these oceanic species arrived in Central Europe. Previous authors (e.g. Herzog 1926) described the distribution of oceanic species and their isolated occurrences "at the humid, oceanic leeward flanks of the mountains in Central Europe", but did not make any attempt to explain this distribution.

Two explanations seem possible.

(1) The populations in Central Europe are relicts of a former larger range in the Holocene and survived in suitable habitats in the mountains of Central Europe, which have a similar climate as in Western Europe with high humidity and low temperatures. There are two climatic periods in the Holocene which were more humid than today (Schwarzbach 1993, Schönwiese 1995). The Atlantic Period (5-7000 b.p.), so called postglacial climatic optimum with mean annual temperatures, which were 2-3°C higher than today. It was the period when mainly Mediterranean (faunistic and floristic) elements invaded Central Europe and survived there in microclimatic favourable habitats (Stewart & Lister, 2001; Hewitt, 2004a). The Subatlantic Period (< 2500 b.p.) was 1-2° cooler than today and even more humid but suitable for the invasion of Atlantic species. (2) The populations in Central Europe

are the result of either a single or several independent dispersal events from Western Europe.

The taxonomic problems involved with this species as well as the range with several disjunct occurrences in Central Europe, raise several questions. The aims of this study are: 1) To clarify the taxonomic position of *Isothecium holtii*, whether it is a good species as suggested by Kindberg, a “small species”, or a variety as proposed by some authors, 2) to clarify its relationship to *I. myosuroides* or *alopecuroides*, and 3) to assess whether the populations of this species in Central Europe are a result of a long distance dispersal from one or more populations in Western Europe or whether these disjunct occurrences are the result of a long lasting isolation and relicts of a formerly continuous range.

Materials and methods

Plant material. *Isothecium holtii* differs by metallic lustrous shine, often yellowish-orange colour, and large plants. They are dendroid and the branches are similarly incurved when dry as those of *Thamnobryum alopecurum*. The species is found in Western Europe beside waterfalls and fast running streams very distinctly just above *Thamnobryum alopecurum*, with which it can easily be confused, especially in shady sites, where *I. holtii* is deep green and not golden-yellowish. Düll (in Düll *et al.* 1996) had collected the species in the Rur valley in the Eifel Mountains before it was discovered by De Zuttere but named it as *Platyhypnidium* or *Thamnobryum*. The plant material used for this study is listed in Table 1 with gene bank accession numbers. Voucher specimens are deposited in herbarium Frahm (BONN). One sequence of *Isothecium myosuroides* was taken from gene bank data under accession number AY737479.

DNA isolation, PCR and sequencing. Prior to DNA extraction the plant material was thoroughly cleaned with distilled water and additionally treated by ultrasonic waves

for 2-4 minutes. Success of cleaning was checked by examining the plants under a binocular microscope. Remaining contaminations e.g. with algae and fungi were removed mechanically. Isolation of DNA was carried out following the CTAB technique described in Doyle & Doyle .

PCR amplifications (Biometra TriBlock thermocycler, PTC-100 MJ Research) were performed in 50 µl–reactions containing 1.5 U *Taq* DNA polymerase (Genecraft), 1 mM dNTPs-Mix, nucleotide concentration 0.25 mM each (PeqLab), 1x buffer (Genecraft), 2.5 mM MgCl₂ (PeqLab) and 40 pmol of each amplification primer. PCR products were purified using the QIAquick gel purification kit (Qiagen). Cycle sequencing reactions (half reactions) were performed using a Biometra TriBlock thermocycler (PTC-100 MJ Research) in combination with the ABI Prism™ Big Dye Terminator Cycle Sequencing Ready Reaction Kit with Amplitaq-DNA polymerase FS (Perkin Elmer), applying a standard protocol for all reactions. Extension products were precipitated with 40 µl 75 % (v/v) isopropanol for 15 min at room temperature, centrifuged with 15,000 rpm at 25°C, and washed with 250 µl of 75 % (v/v) isopropanol. These purified products were loaded on an ABI 310 automated sequencer (Perkin Elmer) and electrophoresed. For cycle sequencing 10 µl–reactions were used containing 3 µl of Big Dye Terminator Cycle Sequencing premix. Sequencing reactions were performed with the reverse primer for either ITS 1 (ITS-C bryo) or ITS 2 (ITS4-bryo).

Primers for amplifying and sequencing the ITS region (ITS4-bryo and ITS5-bryo) based upon the primers “ITS4” and “ITS5” respectively, designed and named by White *et al.*, were slightly modified with respect to bryophytes. The primers ITS-C and ITS-D were modified for this study (ITS-D_bryo and ITS-C_bryo) and used for amplification of ITS 1 and ITS 2 and for sequencing reactions (Table 4.). ITS 1 was amplified with primers ITS5 –bryo (forward primer) and ITS-C bryo (reverse primer). ITS 2 was amplified with primers ITS-D bryo (forward primer) and ITS4-bryo (reverse primer).

The ITS region was amplified using a protocol consisting of: 5 min. 94°C, 35 cycles (1 min. 94°C, 1 min. 48°C, 1 min. 72°C, increased by 4 sec. Per cycle) and a 5 min. 72°C extension time, Cycle sequencing settings: 25 cycles (30 sec. 96°C, 15 sec. 50°C, 4 min. 60°C).

ITS 1 and ITS 2 were separately amplified, because we were able to get a more specific PCR product by this approach rather than amplifying the whole ITS region by the primers ITS4-bryo and ITS5-bryo.

All sequences will be deposited in EMBL, accession numbers are listed in Table 7., the alignments are available on request from the authors.

Table 7. Specimens of *Isothecium* used for DNA extraction.

Species	Country	Location	Collector	Genebank Accession Number
<i>I. alopecuroides</i>	France	Vosges, Lac de Retournemer	Frahm V5080	AJ937833
<i>I. alopecuroides</i>	France	Vosges, Saut du Bouchout	Frahm V5182	AJ37834
<i>I. holtii</i>	France	Finistère	Frahm 26.9.03	AJ964878
<i>I. holtii</i>	France	Corèze	Frahm 6872	AJ964879
<i>I. holtii</i>	Germany	Harz, Warme Bode	Müller 27.5.01	AJ964880
<i>I. holtii</i>	Germany	Harz, Harzburg	Koperski 22.9.96	AJ964881
<i>I. holtii</i>	Great Britain	Wales	Lansdown SN850514	AJ964882
<i>I. holtii</i>	Great Britain	Shimna River	Blockeel 28/199	AJ964884
<i>I. holtii</i>	Ireland	Lismore	Preston May 1999	AJ964883
<i>I. holtii</i>	Germany	Rurtal near Aachen	Frahm, May 2004	AM182055
<i>I. holtii</i>	Germany	Rurtal near Aachen	Frahm, May 2004	AM182056
<i>I. myosuroides</i>	Germany	Rurtal near Aachen	Frahm, November 2005	AM182054

Phylogenetic analyses. Heuristic searches under the parsimony criterion were carried out under the following options: all characters unweighted and unordered, multistate characters interpreted as uncertainties, gaps coded as missing data, performing a tree bisection reconnection (TBR) branch swapping, collapse zero branch length branches, MulTrees option in effect, random addition sequence with 1000 replicates.

Furthermore, the data sets were analysed using *winPAUP* 4.0b10 executing the command files generated by 'PRAP', employing the implemented parsimony ratchet algorithm. For the parsimony ratchet the following settings were employed: 10 random addition cycles of 200 iterations each with a 40 % upweighting of the characters in the PRAP iterations. Heuristic bootstrap searches under parsimony criterion were performed with 1000 replicates, 10 random addition cycles per bootstrap replicate and the same options in effect as the heuristic search for the most parsimonious tree (MPT). The consistency index, retention index (RI), and rescaled consistency index were calculated to assess homoplasy.

Maximum Likelihood analyses were executed assuming a general time reversible model (GTR+G+I), and a rate variation among sites following a gamma distribution (four categories represented by the mean), with the shape being estimated and the molecular clock not enforced. According to Akaike Information Criterion GTR+G+I was chosen as the model that best fit the data by Modeltest v3.06, employing the windows front-end. The proposed settings by Modeltest v3.06 (table 16) were executed in *winPAUP* 4.0b10. In addition to the MP analyses Bayesian Inferences with MrBayes3.0 were performed. Modeltest 3.5 was used to select DNA substitution models for the data set (gamma shape distribution, six substitution types). The Markov Chain Monte Carlo (MCMC) analyses were run for 2,000,000 generations with four simultaneous MCMCs and one tree per 100 generations was saved. The 'burn-in' values were determined empirically from the likelihood values. The analyses were repeated three times to assure sufficient mixing by confirming that the program converged to the same posterior probability (PP).

The program Treegraph was used to edit trees directly from PAUP-treefiles.

Results and discussion

The alignment length of the ITS1-5.8S-ITS2 region was of 763 base pairs (bp) in total. The shortest sequences were in *I. alopecuroides* – FR, Dept. Lac de Retournemer (575 bp) and the longest in *Isothecium myosuroides* from Belgium (661 bp). Within *Isothecium holtii* specimens, sequence lengths vary from 591 (DE, Rurtal bei Aachen 2) till 630 bp (DE, Harz, Tal der Warmen Bode). Of the aligned sequences, 1972 positions were gapped sites and excluded from further analysis. Of the remaining sites, 662 sites were constant, 14 variable and parsimony-uninformative and 86 were parsimony-informative. All characters were equally weighted. Gaps were treated as “missing”.

The trees derived from ITS2 viz. ITS 1/2 show the same topology. Also the ITS1/2 trees calculated with Maximum Parsimony (Fig. 22.) or Neighbour Joining are identical. The position of selected populations in the tree shows that there is high genetic variation among them. This might be a result of lacking gene exchange caused by sterility of the populations and might reflect the scattered distribution of the species and the fact that we have even within the main range no real closed range but several isolated occurrences instead.

The tree shows that all three species, *I. holtii*, *myosuroides* and *alopecuroides* are well separated. *Isothecium holtii* is rooted together with *I. myosuroides*, thus showing a closer relationship to the latter than to *I. alopecuroides*. The analysis revealed that *Isothecium holtii* is a good species. The closer relationship of *I. holtii* to *I. myosuroides* compared to *I. alopecuroides*, is in accordance with the opinion of older authors such as Mönkemeyer (1927) and Nyholm (1954 ff.). Molecular evidence is in contrast to morphology, as *I. holtii* resembles more *I. alopecuroides* in its robust appearance and leaf shape.

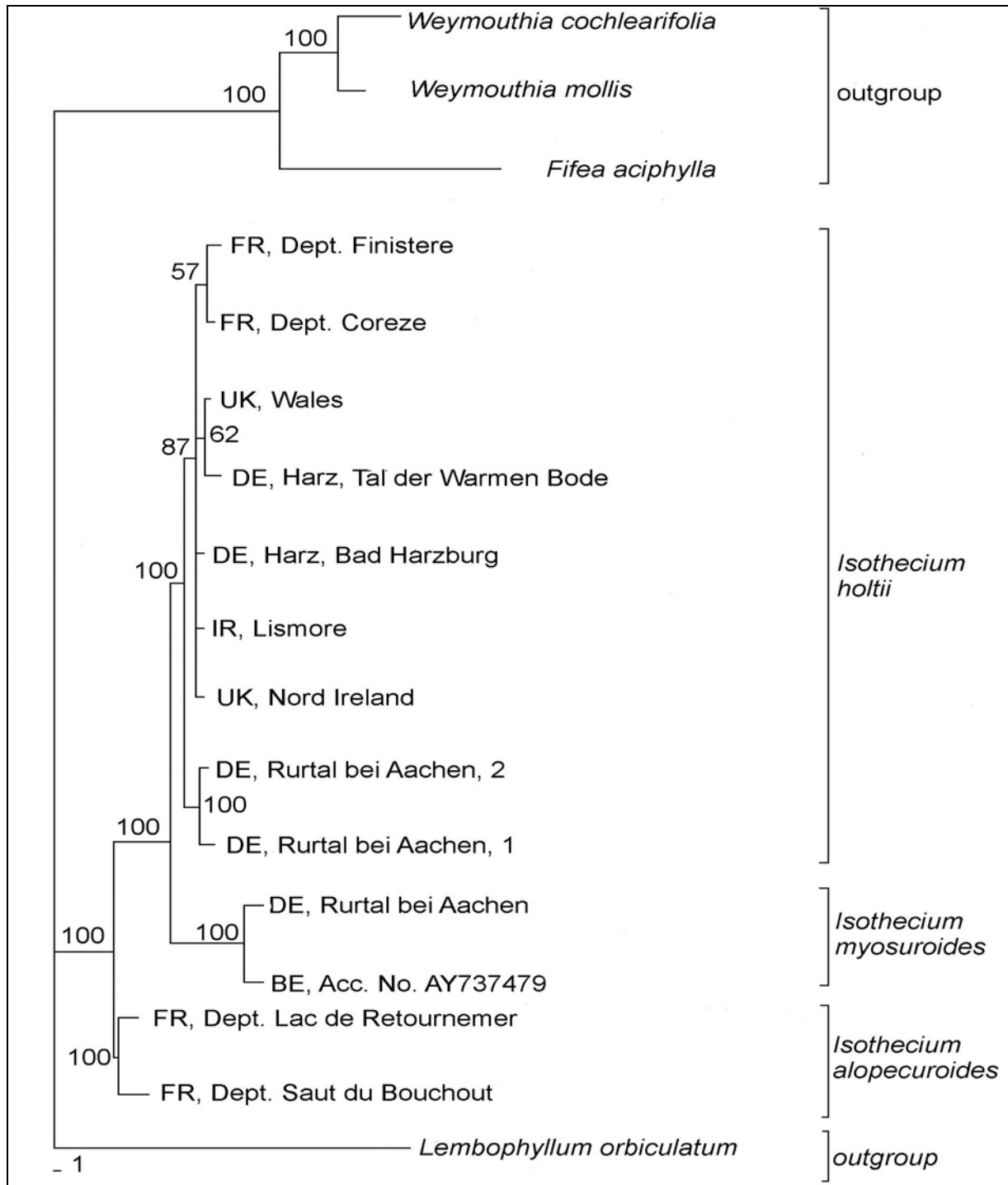

Fig. 22. Maximum Parsimony Tree of ITS1/2 sequences of *Isothecium holtii*, *I. alopecuroides* and *I. myosuroides*.

The populations of *I. holtii* from the Harz Mountains are from two different valleys. Interestingly, both are neither identical nor do they cluster in one branch but group together with populations from Ireland and Wales. This indicates two different dispersal events by spores from Western Europe probable. The French populations in Brittany and the Massif Central root together and thus seem to be of a common origin. They also root together with the populations in Britain and Ireland, which indicates that gene exchange sometimes in the past. The two populations of *I. holtii* from the Eifel Mountains (Rurtal near Aachen) in Germany are basal to and isolated from all other studied populations of *I. holtii*. This pattern may speak in favour of these populations being relict of a previous wider distribution in Western and Central Europe.

The results of our study indicate that both the relict and the dispersal hypothesis may account for the occurrences of *I. holtii* in continental Europe. The Harz-German populations clustering with those from Western Europe are consistent with a hypothesis of relatively recent dispersal. These are the easternmost populations in Germany, and may never have been part of a continuous range in earlier climatic periods. Our data indicate that long range dispersal is possible in this species, despite lack of vegetative propagation and rare sporophyte production. (Mönkemeyer (1927) does not even mention sporophytes, Smith (1978) mentions rare sporophyte production).

Acknowledgements

We wish to thank Sarah Preston, Monika Koperski, Tom Blockeel, Frank Müller and Michael Lüth, who contributed specimens to this study, and Rolf Blöcher for support during lab work.

3.4. Paper 4:

Genetic diversity and phylogeography of the moss *Rhytidium rugosum* (Hedw.)
Kindb. (Hypnales) in Europe (by Sabovljević, M. and Frahm, J.-P., submitted)

Abstract

Genetic diversity and phylogeography in of the boreal moss species *Rhytidium rugosum* have been studied. The species is considered to be glacial relict of the wide but scattered Holarctic range. According to molecular data sampling from the selected European, American and Asian population high genetic diversity of this species is present, even if this species is mostly sterile and produced sex organs extremely rarely and spread mostly asexually. Analysing the Internal Transcribed Spacer (ITS) of the nuclear ribosomal DNA, it can be concluded that the populations of this species survived in various places in Europe and settled and re-settled present range space in various times from various refuges.

Introduction

Climatic and environmental changes during the Pleistocene have had significant impacts upon the habitat and natural range of many species (Hewitt, 1993, 2000). In temperate latitudes of the Northern Hemisphere southward range shifts and contractions during cold periods into so-called glacial refugia have been followed during warmer interglacials by northerly range shifts and recolonizations. Genomic evidence of quaternary glacial events has been considered by many researchers (Hewitt, 1996, 1999, 2001; Taberlet *et al.*, 1998 and Avise, 2000). Helvitt (2004a) states four major refugia in Europe (the Iberian, the Appenine and the Balkan peninsulas as well as the Caspian/Caucasus regions).

However, most considerations have been made for higher animal and plants and there are very few approaches of the glaciation influence to other groups of organisms. For the bryophytes there have been few, but very valuable contributions on genetic diversity and phylogeography published up to date (Shaw and Schneider, 1995; Bischler and Boisslelier-Dubayle, 1997; Wyatt *et al.*, 1997; Cronberg, 2000; Shaw, 1995, 2000, 2001; Chiang and Schaal, 1999; McDaniel and Shaw, 2003; van der Velde and Bijlsma, 2003; Skotnicki *et al.*, 2004; Werner and Guerra, 2004)

The present study examined patterns of the population genetic variation in the wide distributed moss *Rhytidium rugosum*, and presents the first genetic insights into geographic history of this species. For this purpose nuclear ribosomal Internal Transcribed Spacer regions are used considering its plant phylogeographic study values, although there are some limiting factors such as its multi-copy nature, hybridisation, polyploidy and concerted evolution (e.g. Barker *et al.* 2003). However, in order to construct gene trees (for phylogeographic use), significant genetic variation must occur at the appropriate level; i.e. among populations (Schaal *et al.*, 1998). Nuclear ribosomal ITS appears to be particularly useful in bryophyte studies (Shaw, 2000; Shaw *et al.* 2003; Barker *et al.* 2003) due to its high variation, and especially in species with no or low sex cross-over and no or low spore production.

The pleurocarpous moss *Rhytidium rugosum* (Hedw.) Kindb. is a monotypic species and genus within the family of *Rhytidiaceae* placed in the order Hypnales.

Rhytidium rugosum grows in open, dry and preferentially basic habitats.

The species has a circumpolar scattered range from the Arctic to the Mediterranean. However, it can be considered as boreo-montane species (Frahm, 2005). In Central Europe the species “behaves like a thermophilous element”, being confined to the warmer parts (especially with viniculture) and growing in dry grasslands together with other thermophilous elements, both phanerogams, ferns and bryophytes. A look at the whole range, however, reveals that the species is also found north to the arctic, both in Europe and North America (Alaska, northern Canada, and Greenland). It goes also up in the mountains to more than 2000 m as in the Alps. The reason for its “thermophilous behaviour” seemed therefore that it is not a species of warm habitats but requires open habitats, either in the Mediterranean, in Central Europe or in the arctic.

The major problem involved with this species is, that it is found in Central Europe almost always sterile and the question, how the species was dispersed from its supposed refugia in southern Europe to Central Europe after glaciation remains unsolved. Thus the sterility of this species could be a reference to its persistence in Central Europe.

Even though it is widespread, *Rhytidium rugosum* is infrequent, presumably because of a preference for exposed calcareous or mafic bedrock range wide mostly in a cool habitat. The species is rarely found with sporophytes. Perhaps almost total reliance on asexual reproduction explains the strong morphological uniformity seen among specimens of *R. rugosum* collected from across its broad range. Though, morphological characters indicated not high genetic diversity and easy dispersal, which is, not know up to date.

Materials and methods

Sampling and outgroup choice. An attempt was made to sample from a wide range of sparsely distributed *R. rugosum*. Material from 41 populations was acquired for this study. The sampling included 28 European, 5 North American and 8 Asian localities. Related species, *Hypnum cupressiforme* (Acc. No. AY528888/AF403607) and *Ctenidium moluscum* (AF230989/AF231004) were chosen as outgroup taxa, and their sequences were taken from the EMBL gene bank. Vouchers are in the University of Bonn Herbarium BONN, unless otherwise indicated.

PCR and DNA sequencing. Prior to DNA extraction the plant material was thoroughly cleaned with distilled water and additionally treated by ultrasonic waves for 2-4 minutes. Success of cleaning was checked by examining the plants under a binocular microscope. Remaining contaminations e.g. with algae and fungi were removed mechanically. Isolation of DNA was carried out following the CTAB technique described in Doyle & Doyle.

PCR amplifications (Biometra TriBlock thermocycler, PTC-100 MJ Research) were performed in 50 µl-reactions containing 1.5 U *Taq* DNA polymerase (Genecraft), 1 mM dNTPs-Mix, nucleotide concentration 0.25 mM each (PeqLab), 1x buffer (Genecraft), 2.5 mM MgCl₂ (PeqLab) and 40 pmol of each amplification primer. PCR products were purified using the QIAquick gel purification kit (Qiagen). Cycle sequencing reactions (half reactions) were performed using a Biometra TriBlock thermocycler (PTC-100 MJ Research) in combination with the ABI Prism™ Big Dye Terminator Cycle Sequencing Ready Reaction Kit with AmpliTaq-DNA polymerase FS (Perkin Elmer), applying a standard protocol for all reactions. Extension products were precipitated with 40 µl 75 % (v/v) isopropanol for 15 min at room temperature, centrifuged with 15,000 rpm at 25°C, and washed with 250 µl of 75 % (v/v) isopropanol. These purified products were loaded on an ABI 310 automated sequencer (Perkin Elmer) and electrophoresed. For cycle sequencing 10 µl-

reactions were used containing 3 µl of Big Dye Terminator Cycle Sequencing premix. Sequencing reactions were performed with the reverse primers for either ITS1 (ITS-C bryo) and ITS2 (ITS4 bryo) or forward primers for either ITS1 (ITS5 bryo) or ITS2(ITS-D bryo).

Primers for amplifying and sequencing the ITS region (ITS4-bryo and ITS5-bryo) based upon the primers “ITS4” and “ITS5” respectively, designed and named by White *et al.*, were slightly modified with respect to bryophytes. The primers ITS-C and ITS-D were modified for this study (ITS-D_bryo and ITS-C_bryo) and used for amplification of ITS 1 and ITS 2 and for sequencing reactions (Table 4). ITS 1 was amplified with primers ITS5 –bryo (forward primer) and ITS-C bryo (reverse primer). ITS 2 was amplified with primers ITS-D bryo (forward primer) and ITS4-bryo (reverse primer).

The ITS region was amplified using a protocol consisting of: 5 min. 94°C, 35 cycles (1 min. 94°C, 1 min. 48°C, 1 min. 72°C, increased by 4 sec. Per cycle) and a 5 min. 72°C extension time, Cycle sequencing settings: 25 cycles (30 sec. 96°C, 15 sec. 50°C, 4 min. 60°C).

ITS 1 and ITS 2 were separately amplified, because we were able to get a more specific PCR product by this approach rather than amplifying the whole ITS region by the primers ITS4-bryo and ITS5-bryo.

All sequences are deposited in EMBL, accession numbers are listed in Table 8., and the alignments are available on request from the authors.

Phylogenetic analyses were performed with *winPAUP* 4.0b10, to calculate Maximum Parsimony, Maximum Likelihood and Neighbor Joining Trees.

Heuristic searches under the parsimony criterion were carried out under the following options: all characters unweighted and unordered, multistate characters interpreted

Table. 8. Rhytidium specimens with Gene Bank Accessions Numbers:

Origin	Collection data	Accession Number
Mongolia	Gobi, leg. M. Ignatov	AM229018
Russia	Altai Mts., leg. O. Pisarenko	AM229019
Russia	Karelia, Pitkäranta District, leg. S. Huttunen & H. Wahlberg	AM229020
Germany	Kr. Cochem, Dortebacktal, leg. J.-P. Frahm	AM229044
Spain	Guadalajara, Checa, leg. B. Albertos <i>et al.</i>	AM229021
Spain	Teruel, Orihuel del Tremedal, leg. C. Gimeno	AM229022
France	Dépt. Dordogne, leg. J.-P. Frahm	AM229025
Italy	Western Italian Alps, Aosta Valley, leg. M. Sabovljević	AM229026
France	Dépt. Pyrénées, leg. J.-P. Frahm	AM229027
Spain	Navarra, Sierra de Leyre, leg. A. Ederra	AM229023
Spain	Asturias, Pto. Ventana, leg. M. C. Fernandez	AM229024
Serbia	Kopaonik Mt., leg. M. Sabovljević	AM229055
Serbia	Novi Pazar, Sopoćani, leg. B. Papp	AM229056
Bulgaria	Balkan Mt., leg. A. Ganeva	AM229057
France	Dépt. Puy-de-Dôme, leg. J.-P. Frahm	AM229029
France	Dépt. Haute-Rhin, Vosge Mts., leg. J.-P. Frahm	AM229030
France	Lothrigam, leg. J.-P. Frahm	AM229031
Switzerland	S Luzern, Alpnacher See, leg. J.-P. Frahm	AM229032
Germany	Kr. Bad Münstereifel, leg. J.-P. Frahm	AM229034
Germany	Kr. Cochem, Moseltal, leg. J.-P. Frahm	AM229035
Hungary	Borson-Abaúj-Zemplén, leg. M. Rajczy	AM229028
Hungary	Zemplén Mts., leg. B. Papp	AM229033
Montenegro	Durmitor Mt., leg. B. Papp	AM229036
Slowenia	Julijske Alpe, Pl. Bukovec, leg. J.-P. Frahm	AM229037
Germany	Kr. Daun, leg. J.-P. Frahm	AM229038
Germany	Kr. Limburg, leg. J.-P. Frahm	AM229039
Germany	Kr. Euskirchen, leg. J.-P. Frahm	AM229040
Germany	Kr. Heidelberg, leg. J.-P. Frahm	AM229041
Russia	South Urals, Bashkiria, leg. Konovalova	AM229042
Russia	Caucasus, leg. M. Ignatov	AM229043
Russia	Kola Peninsula, leg. M. Ignatov	AM229045
Russia	CentralEuropean Russia, Kursk, leg. M. Ignatov	AM229046
Russia	Altai, Mts., leg. Zolotukhin	AM229047
Russia	Russian Far East, Khabarovsk, leg. M. Ignatov	AM229048
Russia	Jakutia, Siberia, leg. Krivoschapkin	AM229049
USA	South Dakota, leg. S. P. Churchill	AM229051
Canada	Alberta, leg. J.-P. Frahm	AM229050
Canada	British Columbia, leg. D. Vitt	AM229054
Mexico	Hidalgo, leg. C. Delgadillo	AM229052
USA	Colorado, leg. Weber & Withmann	AM229053
Taiwan	sequence from Gene Bank	AJ288548 AJ288334

as uncertainties, gaps coded as missing data, performing a tree bisection reconnection (TBR) branch swapping, collapse zero branch length branches, MulTrees option in effect, random addition sequence with 1000 replicates.

Furthermore, the data sets were analysed using *winPAUP* 4.0b10. For the parsimony ratchet the following settings were employed: 10 random addition cycles of 200 iterations each with a 40 % upweighting of the characters in the PRAP iterations. Heuristic bootstrap searches under parsimony criterion were performed with 1000 replicates, 10 random addition cycles per bootstrap replicate and the same options in effect as the heuristic search for the most parsimonious tree (MPT).

Results

The combined length of the ITS1-5.8S rRNA – ITS2-partial 25S rRNA region was 652 bp (Spanish Teruel population) to 709bp (Mongolia population). The ITS1 region was highly variable with multiple indels and ranged from 222bp (Serbian Sopocani population) to 270bp (Spanish Guadalajara population). Length of 5.8S rRNA was invariable (101bp) in all accessions. The ITS2 length measured 276bp (Spanish Navarra population) to 339bp (Canadian Alberta population). Within European population ITS2 length goes up to 330 in German Heidelberg population, while it measure over 330 in all NorthAmerican and Asian populations. The alignment of complete regions analysed was 917 positions long due to indels in ITS1 and ITS2 regions. For the tree construction, 847 positions of ITS1 and ITS2 were used, including 19 variable and 51 parsimony informative ones.

All clades are bootstrap supported with values over 81. The similar branching pattern and clade organisation to Parsimony tree (Fig. 23) has been shown in both Maximum Likelihood and Neighbor Joining trees, dough in Maximum Likelihood it was generally lower bootstrap support, which may be due to the fast bootstrap procedure and exclusion of the indel characters.

Genetic distances and phylogeography of selected disjunct moss populations in Europe
Marko Sabovljević

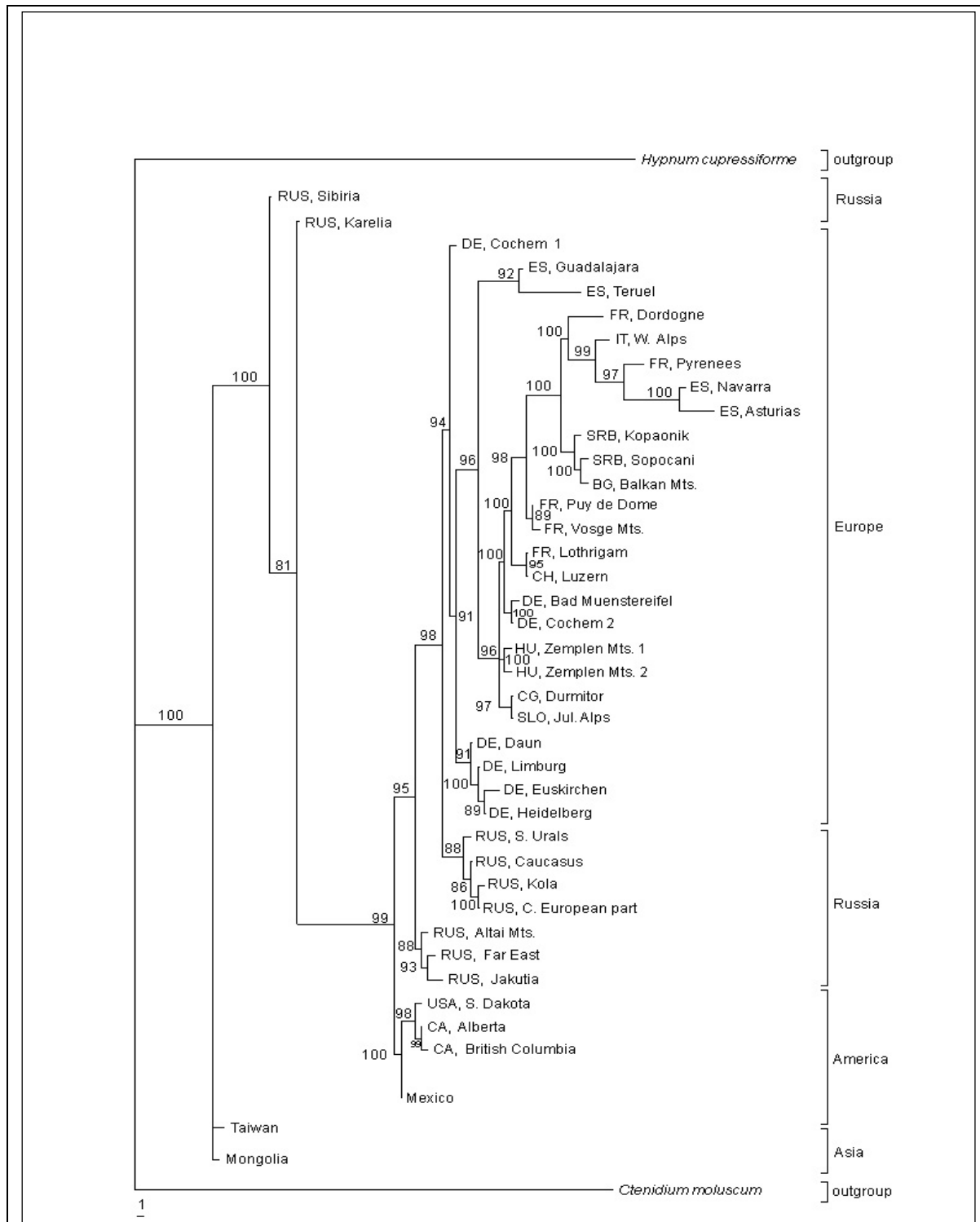

Fig. 23. The Most Parsimonious Tree of selected *Rhytidium rugosum* populations with the bootstrap values above branches.

According to the uncorrected “p” distance analyses, the distances among selected population of *R. rugosum* varied from 73.9 (Bulgarian and Dakota population) till 95.2 (Mongolian and Taiwanese population). The highest similarity in Europe according to uncorrected “p” distance was between the Spanish-Navarra population and the Western Italian Alps populations (85.7). The lowest similarity in Europe (77.3) is between Spanish Teruel and Russian Karelian populations.

The content of GC in the sequences analysed (ITS1-5.8SrNA-ITS2-partial 25SrRNA) is variable but equilibrated (57.35-61.86%). Interestingly, within the same clade GC content varies less than among all sampled populations.

Discussion

According to molecular data it seems to be that central Spanish populations are long time isolated from other south European populations (Fig. 24), and that these populations have been established during Pleistocene but did not spread in the Holocene. The Northern Spanish populations are related with populations from Pyrenees, adjacent regions and the Western European Alps. The Eastern European Alps population has a sister population in the continuing range of the Dinaric Alps. Serbian populations are clustered with Bulgarian population and form the Central Balkan group.

In France, there are two groups of haplotypes expressing potential migration routes from the Pyrenees and Switzerland. Western German populations comprise three quite different haplotypes expressing the possibility of west European refugia of *R. rugosum*. However, due to the high variability and quick evolution in the nrITS region used in these study, absence of sexual reproduction and gene flow this refugial consideration should be taken carefully since there was the highest sampling resolution in Western Germany, which makes explanation more difficult. Pfeiffer *et al.*

(2006) suggest high genetic diversity among populations even in very limited geographical space for *R. rugosum*.

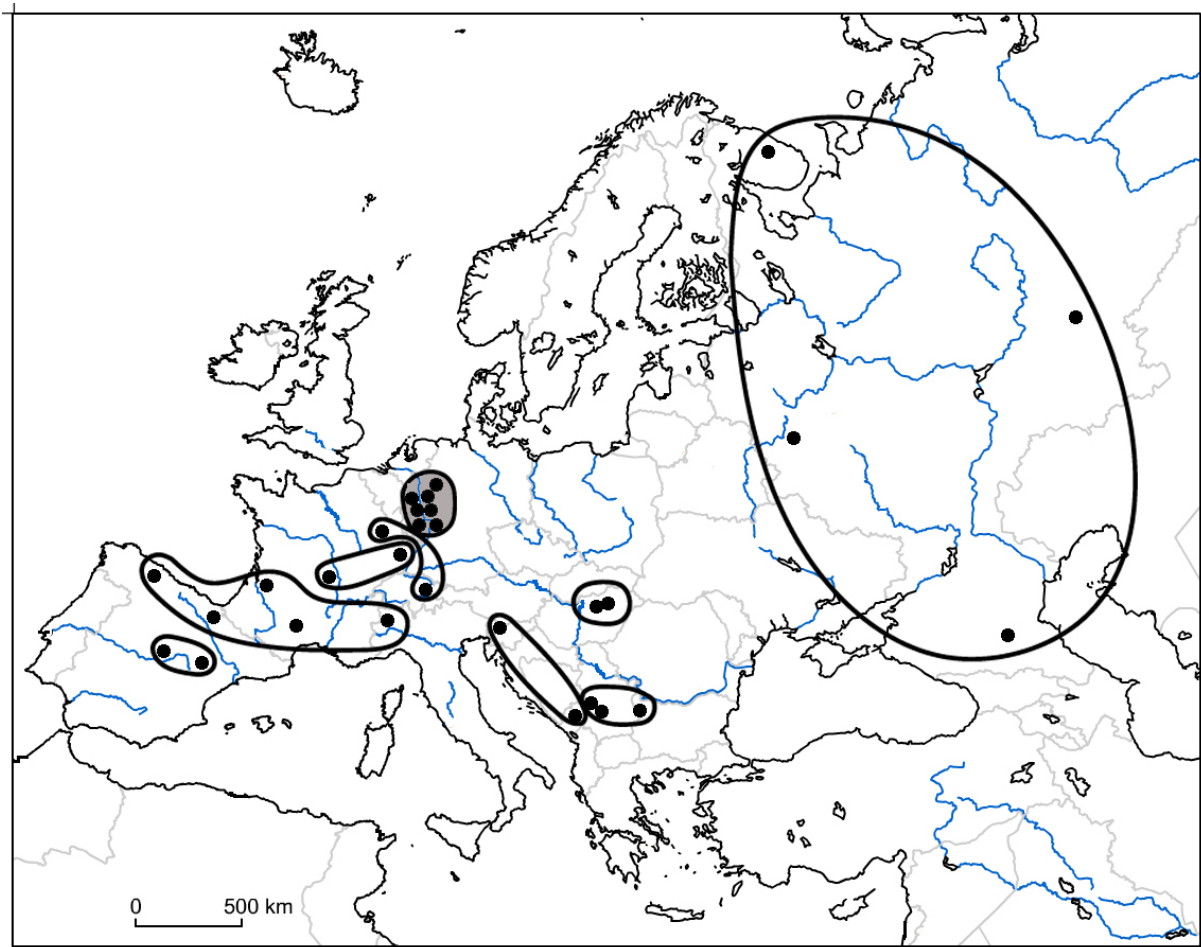

Fig. 24. The analysed populations of *Rhytidium rugosum* from Europe. Related haplotypes are grouped together. The zone with highest haplotype numbers are presented in gray.

Generally, where genomes from two or more refugia come together, genetic diversity will be increased by the presence of diverged lineages, as seen in hybrid and suture zones. Two populations with no inbreed event, living in the same region in similar

habitats, but from different colonizing refugia will possess very different alleles and genomes, while conversely two very distant populations in distinct habitats may have the same refugial genome. This points to the importance of population history in the process of post glacial adaptation, and our understanding of it. So, it can be considered that western Germany has relic populations as well as ones lately settled during their migrations from southern refugia. Also, there is molecular evidence that some parts of Germany were so called northern refugia for some other groups of organisms (e.g. Hänfling *et al*, 2002; Pinceel, 2005). Besides, some regions like Belgian Ardennes, SW England, NE Hungary, SW Ireland, NW Scotland and W Slovakia are known as cryptic refugia (Stewart and Lister, 2001) where also fossil evidence suggests survival of some tree and mammal species, so hypothetically place for survival of some moss populations, as well.

The populations from European Russia according to nr ITS all derives from the refugial site situated in Caucasus region.

The Balkan populations for many biota provided main genomic source for postglacial colonisations, probably due to the deep canyon passes directed south-north. Less came from Iberia and Italy probably hindered by the ice-capped and hardly to pass Pyrenees and Alps (Hewitt, 2004).

Many European species phylogeographies are emerging and a considerable number broadly show these distribution patterns and probably followed similar colonization routes despite differences in their niche, mobility and life history. This apparent and remarkable commonality would seem to be a result of colonization following postglacial climate change in Europe's particular geography of southern peninsulas, transverse mountain ranges and northern plains. It demonstrates the explanatory power of combined phylogeography and paleoclimatology.

During the Last Glacial Maximum (23-18 kyr) the ice sheets and permafrost extended towards lower latitudes, so that generally species distributions were compressed toward the equator. Boreal species survived south of the ice in North America and Europe, but large areas of the north eastern Palearctic and Beringia remained ice free and some cold-hardy species appear to have survived here. Temperate species survived further south where habitats occurred to which they were already adapted. In Europe the disjunct southern peninsulas of Iberia, Italy and Balkans were particularly important, while in North America many temperate locations occurred around 40°N between the East and West coasts (Hewitt, 2004b). All this is in accordance with our data for the moss *R. rugosum*.

As a consequence, the habitats of many Boreal, Temperate and Tropical species were reduced and fragmented and they survived in refugia; but for some their habitats expanded, like those in the tundra and savannah. As the climate warmed after the latest glacial maximum and the ice retreated, many boreal and temperate species were able to expand their ranges, as were some tropical species. In some cases the refugial populations died out, but particularly in mountainous regions they could survive by ascending with the climate and their niche, as for example in the Alps, Andes, Appalachians and Arusha mountains. Such refugial regions allow the survival of species through several ice age cycles by ascending and descending to track their habitat, e.g. (Hewitt, 2000). This consideration should always be taken in assumption for the bryophytes, which are bio-chemically and physiologically adapted to survive freezing and long time under the ice. So, "nunatak" theory for surviving of some population cannot be excluded. Moreover, the molecular data set now gained leaves many space for such consideration in some alpine and some boreal regions. Distribution dynamics caused by glaciation-interglaciation cycling events modify the genetic content and structure of populations within species, and leave some traces for which we may search. Populations, races and subspecies that have been effectively separated for several glacial cycles will show divergence through the accumulation of neutral and possibly selected DNA changes. The extent of this

divergence will be proportional to the time of separation. The haplotype tree or network of an evolving DNA sequence will reflect population expansions and contractions.

The contractions, expansions and distant colonisations involved in these late Quaternary range changes would have influenced the genetic diversity, and should have left some signs. Low haplotype diversity and shallow clades are expected when populations have been severely contracted, and the age of the subsequent expansion may be gauged by mismatch analysis. The structure of haplotype networks and nested clades also provide indications of such events. So, having all this in mind combined with our molecular data it can be said that the moss species *R. rugosum* survived glaciation periods in various places in Europe and extended its ranges from these places to more than once and that survived populations mixed without exchanging genetical material which is in accordance with its asexual reproduction and no sporophyte productions.

Conclusions

The frequent major climatic oscillations in the last 2 My caused repeated changes in the ranges of surviving taxa, with extensive extinction and recolonization in higher latitudes and altitudinal shifts and complex refugia nearer the tropics. As a result of these past dynamics, the genetic diversity within species can be highly structured spatially, with a patchwork of genomes divided by often coincident hybrid zones. When asexual spreading occurs this cannot be expected in such a high rate.

The phylogeographical analysis of *R. rugosum* selected populations reveals an intriguing picture of the colonization history of this species in Europe. In Europe, *R. rugosum* probably survived the glaciation in few glacial refuges in southern Europe as well as in situ in Central Europe. From these refuges, major lineages re-colonised Europe in separate directions. According to molecular data, the Iberian Peninsula was one of the European refuge sites. Second and very important refuge was the

Balkans. The genetical structure of the *Rhytidium* population examined show that the Pyrenees range together with the Western Alps, show high genetical similarity, while the Eastern Alps population is more related with the Dinaric Alps population, which is not so close to Central Balkan populations group. Swiss population is related with the Vosges population, indicating that Nunatak theory should also be considered when explaining present phylogeography of the moss *R. rugosum* in Europe. The south and central France populations makes molecularly related group, the most probably survived the latest Ice Age somewhere there. Hungarian populations make separate clade, which just confirms that there was a central European micro-refuge; also know for some other groups of organisms and humans. The European Russian populations derived from the populations that survived Ice Age somewhere in the region of Caucasus and space between the Black and the Caspian seas.

The most impressive and interesting result of genetic differences of *Rhytidium* population is the one in the western Germany. Many different haplotypes have been recorded there, which suggest that the region beside having refugial characteristic (already known for the other groups of organisms), was also the main settling route for colonization-decolonisation processes in the distribution history of *R. rugosum* in Europe.

Acknowledgement

We acknowledge all the colleagues who provide some of material for this study: A. Ganeva, J. Heino, S. Huttunen, M. Ignatov, B. Papp, O. Pisarenko and R.M. Ros.

3.5. Paper 5:

The origin of German population of *Dichelyma capillaceum* inferred by *trnL*-F plastid DNA sequences (by Sabovljević, M. and Frahm, J.-P., submitted)

Abstract

The genetic relationships of North America, Scandinavian and the only German population of *Dichelyma capillaceum* has been studied, based on the chloroplast sequences of the *trnL-F* region. Inferred from the molecular data obtained, the German population has derived from Scandinavian (Swedish) rather than North American populations. According to the genetic distances among Swedish and German populations the separation must have been long time ago.

Introduction

The dioecious moss *Dichelyma capillaceum* (Fontinalaceae) has very a scattered ampho-atlantic range, mainly represented in the North-Eastern part of North America and Scandinavia (Crum and Anderson, 1981; Ireland, 1989; Nyholm, 1960; Toivonen, 1972). In Europe, most of the populations are situated in southern Sweden (19), but are decreasing (ECCB, 1995; Hylander 1998). Further on, a very few small populations are known from Finland, Poland and Karelia in Russia (Kotiranta et al., 1998). In Estonia, it cannot be refound and populations known from Denmark, Italy and all except one in France are assumed to be extinct (Allorge and Jovet-Ast, 1948; ECCB, 1995). No data on recent populations from Poland and Karelia are available. Each one population from Germany and from France seem to be still present. The records from the Netherlands, Greece and Sicily are reports from 1760, 1851 and 1888, respectively (Touw, 1989; Preston, 1984; Dia et al., 1987), but none of these has been verified. So the actual centres of distributions of this rare and endangered species are North-eastern North America and Northern Europe.

No data on reports of European fossil or subfossil finds of *D. capillaceum* has been found (e.g. Jovet-Ast, 1967; Dickson, 1973) and at least no Quaternary subfossils of this species exist from North America either (Miller, 1980; Janssens, 1983).

Dichelyma capillaceum is yellowish-brown to green, medium sized pleurocarpous aquatic moss growing in small tufts up to 10cm long. Leaves are erect-spreading, slightly falcato secund and lanceolate. Nerve is excurrent in long, aristate point about $\frac{1}{2}$ the length of the leaf. The capsules are extremely rare and immersed. The species is almost without exception sterile in Europe, and it is suspected to have lost its ability to produce capsules due to declining habitat quality and frequencies of male plants (Hedenäs et al., 1996). Currently spreading occurred asexually with the fragments of the young branches. No specialized vegetative dispersal units are known in *D. capillaceum*, but possibly plants can be dispersed vegetatively, either at a limited locality by elongating stoloniferous shoots that are sometimes seen firmly attached to the substrate or, within the a water course by fragmentation (Toivonen, 1972). There is no evidence of long distance dispersal, and the main dispersal vector seems to be stream water.

It inhabits riparian habitats, growing on the tree bark and rocks.

In Europe, this species is treated as vulnerable and is included in Appendix I of the Bern Convention and in Annex 2 of the EC Habitats and Species Directive.

Dichelyma capillaceum has been found in Germany one time between Bonn and Cologne at the beginning of the 20th century (Brasch, 1923). The locality is ca. 1500 km airdistance away from the main European range in Scandinavia (Sweden). Again, Feld (1958) cited the locality without confirming the existence of the populations and mentioned that there are two more literature data for the eastern Germany (Sagan and Westprußen), taken from Mönkemeyer (1927). The searches to find German populations failed over years and Düll (1980) state that the species is impossible to find due to change of landscape and finally considered it as extinct (Düll, 1994). The species was re-found in sterile stage again in 1997, more than seventy years after previous records (Frahm and Stapper, 1998). Even, the species is cited as exclusively sterile as it is mostly over all its present range in Europe, one herbarium specimen from 1923 bears sporophytes.

It is not clear whether the German population settled the present habitat by long distance dispersal originated from either North American or Scandinavian populations or was it there for a long time already. Also, considering that species was not seen for the decades with sporophytes across its range, and no propagules for long range spreading are known, the question of the relationship of German population with representatives in two present centres of its distribution is raised.

Phylogeographical methods have provided the opportunity to elucidate the effects of large-scale historical events (such as Pleistocene climate change) on the distribution and subdivision of biota and put into context the role of reproductive biology in the genetic structuring of species (Vogel et al., 1999).

Material and methods

Chloroplast markers are often successfully applied in plant phylogeography research, because they are more conserved, but also have spacers and introns among genes of chloroplast RNAs, which are useful for studying differences both among populations and genera. Widely used are highly variable spacers positioned between Lysine-tRNA-Exon *trnL* (UAA-3') and tRNA-Gen for Phenylalanine *trnF* (GAA) (eg. Taberlet et al. 1991 and Kelchner 2000). A previous survey demonstrated that this fragment was likely to reveal an informative amount of diversity (Vogel et al., 1996) and has been shown that chloroplast is maternally (i.e. uniparentally) inherited in most plants (Vogel et al., 1998).

DNA was extracted from herbarium specimens using 2X CTAB (hexadecyltrimethylammonium bromide) method as stated in Sabovljevic et al. (in press).

Amplification of the *trnL-F* region (Taberlet et al., 1991) was carried out using the forward primer C and the reverse primer F slightly modified for bryophytes according to Meißner et al., (1998) and Sugiura et al., (2003).

The alignment of the sequences was created manually with the alignment editor Align 32 (Happerle, 2003). PAUP4.0b10 (Swofford, 2002) was used for the calculation of molecular trees.

Maximum parsimony and likelihood as well as neighbor joining analyses were performed with *trnL-F* data sets of selected specimens and a few specimens borrowed from the GenBank. Heuristic search were carried out with the following options: all characters unweighted and unordered, multiseriate characters interpreted as uncertain, gaps coded as missing data, performing TBR branch swapping, collapse zero length branches, MulTrees option in effect. Heuristic bootstrap searches were performed with 1000 replicates, 100 random addition replicates per bootstrap replicate and the same option in effect.

The sequences obtained for selected specimens are deposited in GenBank (Tab. 9), and three additional were used from the data base (AF191505, AF191506 and AF191504).

Tab. 9. Specimens used in this study, with GenBank accession numbers:

Species	Origin	GenBank Acc. No.
<i>Dichelyma capillaceum</i>	Sweden, Vöxjö, leg. K.Hylander	AM259337
<i>Dichelyma capillaceum</i>	Sweden, Sandviken, leg. K. Hylander	AM259338
<i>Dichelyma capillaceum</i>	Sweden, Närke, leg. L. Hedenäs	AM259339
<i>Dichelyma capillaceum</i>	USA, Missouri, leg. B. Summers and C. D. Scott	AM259340
<i>Dichelyma capillaceum</i>	USA, New Hampshire, leg. B. Allen	AM259341
<i>Dichelyma capillaceum</i>	USA, Maine, leg. B. Allen	AM259342
<i>Dichelyma capillaceum</i>	Germany, Brühl, leg. Sabovljevic and Frahm	AM259343
<i>Dichelyma falcatum</i>	USA, from GenBank	AF191505
<i>Dichelyma falcatum</i>	USA, from GenBank	AF191506
<i>Dichelyma uncinatum</i>	USA, from GenBank	AF191504

Results

The results obtained in PAUP analyses clearly showed that the German population is distant from all the other tested populations. Since the species is quite rare and in danger of extinction three North European and three north-eastern North American populations have been chosen for comparison with the German one. Additionally, the *trnL-F* sequences of the two specimens of *Dichelyma falcatum* and one of *D. uncinatum* were added.

The alignment was 424 bp long, consisting of 385 constant characters, 23 variables but parsimony uninformative and 16 parsimony informative. The *trnL* intron contained relatively only one informative site, whereas high levels of informative variation occurred in the *trnL/trnF* spacer. Two informative variations are present in *trnF* gene. The similar pattern of sequence variability is reported for the family Fontinalaceae (Show and Allen, 2000). Considering only the sequences of *Dichelyma capillaceum*, there have not been variations recognized within *trnF* sequence genes. Uncorrected sequence divergence among *D. capillaceum* specimens varied from 0.09612 to 0.07441 (within European specimens only somewhat lower 0.08103-0.07441), while the divergence values among *D. falcatum* and *D. capillaceum* varied from 0.00321-0.00773 and among *D. uncinatum* and *D. capillaceum* 0.00101-0.00211. The distance values among *D. uncinatum* and *D. falcatum* were 0.01256 and 0.01318. The highest distance value within *D. capillaceum* specimen comes between German specimen and the American Missouri specimen.

Discussion

According to the results obtained, inferred from the plastid *trnL-F* sequence region, the German population can be considered to be more related to the northern European ones than to the populations from the American continent. The same

patterns of trees are resulting by Maximum Parsimony (Fig. 25) or Neighbor Joining analyses. The German population is clustered with Swedish Göknalet population, from which however according to the branch length is separated for a long time. This clade makes a common branch with two other tested Swedish populations, which is clustered with the separated branch of the American populations. All are rooted with a branch bearing two other species of *Dichelyma* used in this study.

Considering the results obtained, it can be assumed that German population is long time genetically separated from all the others tested and not just a result of relatively recent long distance dispersal. This can be explained having in mind long geographical isolation and non-sexual reproduction. The German population survived *in situ* or is asexually spread from some other site within sometimes wider but disjoint range of this species.

Several Pleistocene glacial refugia have been proposed for the European biota (Taberlet et al., 1998; Hewitt, 1999). The consensus from previous molecular studies is that taxa emerged from one or more of three southern European main lands (Iberia, Apeninne and Balkans) following the last glacial and presumably also during interglacials. However, congruence in phylogeographical patterns is observed only on a broad scale and most taxa show distinctive patterns of genetic diversity throughout Europe. Molecular and fossil evidence also indicates that some tree species such as common beech (Demesure et al, 1996), black alder (King and Ferris, 1998) and Scots pine (Sinclair et al., 1999) survived the Pleistocene in relatively northern locations (i.e. close to the periglacial zone).

Schneller (1996), Vogel et al., (1999), Suter et al. (2000) and Trewick et al. (2002) showed that low genetic variability is suggestive for recent expansion.

Considering that the German population shows a genotype different from the American ones, and is slightly different but genetically distant from Scandinavian populations, it can be assumed that it originated from Scandinavian one and that its expansion has occurred relatively recently having in mind sterility, German

population size and no propagules for short or long distance dispersal. Species inhabits riparian habitats over its range and in the North America it spreads disjoint from the boreal till the subtropical climate zone always decreasing towards to south. According to this, in European part one would be expected more records southern of the Scandinavia. This fact plus molecular data obtained, inferred that Scandinavian representatives probably have ancestors and in America, where the centre of the range for the genus *Dichelyma* is. German population spread southern by long distance dispersal originated from some Scandinavian ancestor. Since, German population has different genotype and is according to the branch length relatively long separated from the Scandinavian populations to which is related, it can be assumed that German population is isolated from Scandinavian for over 100 years since the time of its establishment. The species is known to have small spores, it is not excluded that the long distance dispersal has occurred with the spores once upon a time when the sporophyte production was still common.

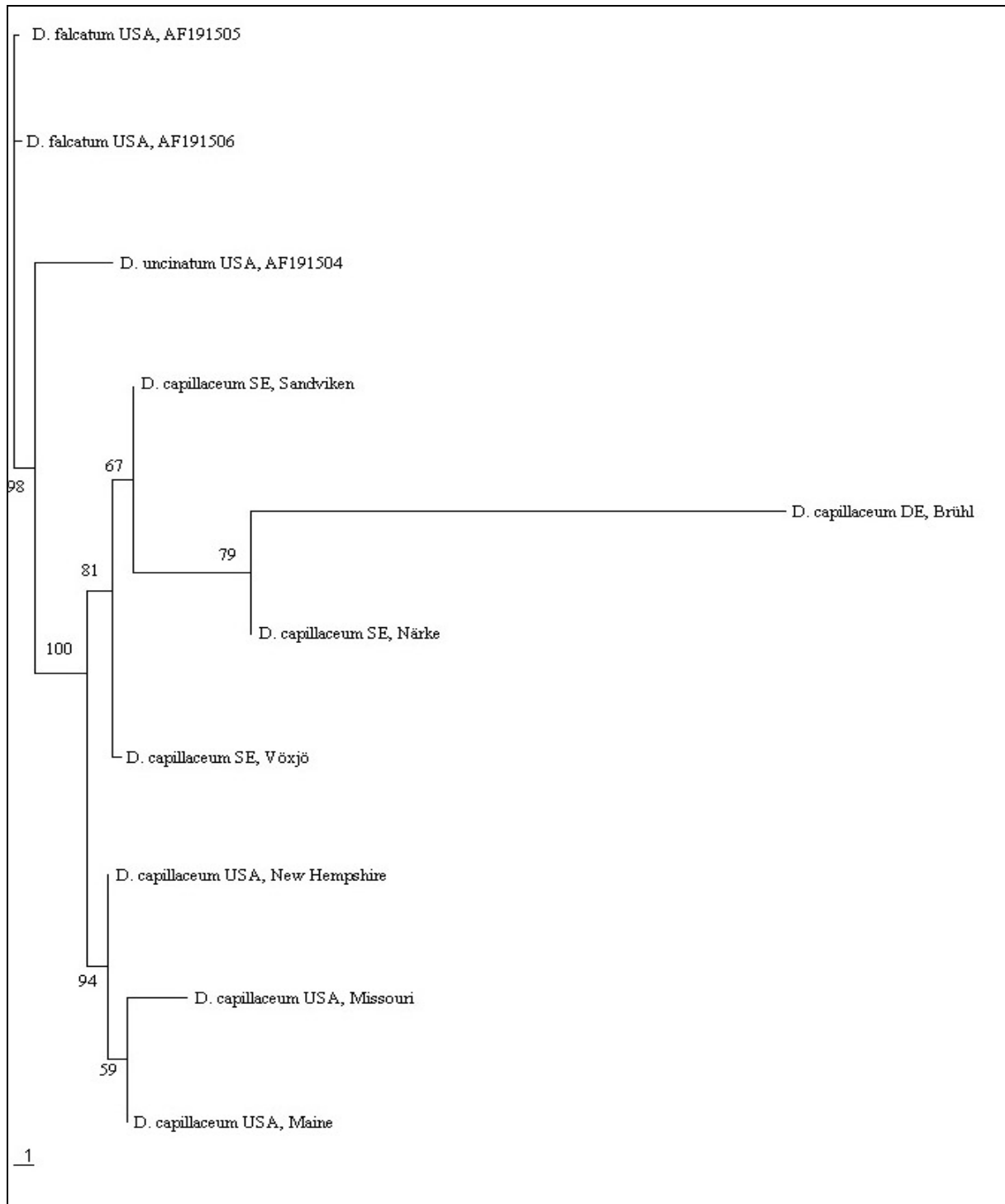

Fig.25. The most parsimonious tree of selected *Dichelyma* populations with the bootstrap values above branches.

4.0. DISCUSSION

Molecular data give the evidence that there is no genetic exchange among population of *Campylopus oerstedianus* in Europe. The population from the Northern Greece form separate clade and thus inferred to be genetically isolated from the rest of European populations for a long period. The populations from the Southern Alps are connected with the western European populations but form a separate branch.

Therefore, it can be concluded that all European population formed once a continuous range, and the present distribution is composed by remnants of former continuous range. Due to sterility of this species, its populations in Europe could not have genetical exchange, which can be the reason for their phylogeographical isolation and its high genetic distances. However, the populations from the Massif Central and the Vosges Mts. root together and have somewhat smaller genetic distances compared to other populations in Europe and thus indicate more recent separations. According to the molecular tree it can be concluded that this population possibly derived from the Spanish populations in the Pyrenées, and that it is rather the result of recent long distance spreading events.

Due to the sterility of the species, vegetative propagation must be taken into account, which to our observation can happen in this species by means of detached stem and leaf tips. This would reveal the potential of long distance dispersal by relatively large diaspores. It is supported by the fact that the populations in Central and North Eastern France are along the route of the prevailing SW-winds. Unfortunately we have no evidence for a determination of the time, when this dispersal happened. If we assume that the separation of the Swiss and French populations happened as a result of the last Ice Age, the dispersal to the North took place in the postglacial period, perhaps during the postglacial climatic optimum 8000 yrs. b.p. It could also be that the separation of the populations in the Pyrenées and the Southern Alps

happened already earlier. In this case the spreading to Central and north-eastern France could also have happened earlier, perhaps even before the last Ice Age.

The possibility of a dispersal from the Pyrenées could be considered as the most appropriate explanation for the phylogeography of *C. oerstedianus* in Europe since there are examples that long-distance dispersal in bryophytes is present by winds, storms, water flows and other means (Muñoz *et al.* 2004). Species with highly disjunct distribution have caused controversy, however, because long-distance migration is thought to be rare (Nathan 2001). Several studies suggest that long-distance dispersal of spore may be more common than previously appreciated (James *et al.* 2001; Skotnicki *et al.* 2001; McDaniel and Shaw 2003). However, empirical estimates of central parameters, such as rates of migration and colonization are still lacking (Husband and Barrett 1996). In *Campylopus*, some atypical spreading by detached leaf tips or part of gametophytes seem to be the most probable propagules for dispersal. Although the predominant means of long-distance dispersal is presumably accomplished by spores (Mogensen 1981; Bremer and Ott 1990; Miles and Longton 1992), some authors suggest gametophyte fragments (Miller and Ambrose 1976; During 1997; McDaniel and Miller 2000) or specialized asexual reproductive structure (Kimmerer 1994) to be responsible for long-distance dispersal in some smaller scale.

According to our molecular data, it can be considered the oldest populations are those in the Pyrenées and in northern Greece. The “p” distance analyses of selected population support the trees. The Greek population has the lowest similarity to all the others (73.2-79.2%), while the greatest similarity showed to be between the two Pyrenées populations (91.8%) and the two Vosges populations (93.6%).

The data gained from selected population of *Hilpertia velenovskyi* show that the Rheinhessen population from Western Germany is genetically quite distinct from the populations in Eastern Germany, Hungary or Serbia. The rather strong genetic

isolation of the population from Western Germany can be explained by a long period without gene exchange. This could be the case in a relict population of the last Ice Age, 13.000 years ago. It has to be considered, that *H. velenovskyi* as a cold loess steppe species could have been part of the flora in Central Europe during the last Ice Age. At that time, similar habitats were provided for the species as nowadays in Siberia or Ellesmere Island. Furthermore, loess was deposited in that time and loess cliffs persisted since that time, providing a constant habitat for bryophytes over the time.

Also, the presence of *H. velenovskyi* in Rheinhessen, can be explained by long-distance dispersal from somewhere inside or outside Europe. According to the tree and branch length of Chinese population, the Rheinhessen population is not related to the latter. The latter hypothesis would be supported by the fact that *Hilpertia* is known in Rheinhessen from only one locality and only recently discovered. On the other hand, a long distance dispersal seems unlikely, since the next populations are in the Caucasus, Mongolia and Siberia, thus quite distant and situated against the prevailing wind system. However, this possibility should not be completely excluded since there are examples that long-distance dispersal in bryophytes are present where unexpected by wind, storms, water flows and other means (Muñoz *et al.*, 2004). Species with highly disjunct distributions have generated controversy, however, because of long-distance migration is thought to be rare (Nathan, 2001).

Several studies suggest that long-distance dispersal of spore may be more common than previously appreciated (James *et al.*, 2001; Skotnicki *et al.*, 2001; McDaniel and Shaw, 2003). However, empirical estimates of central parameters, such as rates of migration and colonization are still lacking (Husband and Barrett, 1996). In *Hilpertia* case, the spores are 10–12 µm in diameter and finely papillose, which seems to be the most probable propagules for dispersal. Although the predominant means of dispersal on a local scale may be by gametophyte fragments (Miller and Ambrose, 1976; During, 1997; McDaniel and Miller, 2000) or specialized asexual reproductive

structure (Kimmerer, 1994), most long-distance dispersal is presumably accomplished by spores (Mogensen, 1981; Bremer and Ott, 1990; Miles and Longton, 1992). Consistent with some spores travelling long-distances, van Zanten (1978) found a strong positive correlation between spore longevity and size of distribution area. Moreover, the spore germination studies of van Zanten (1978) show that species with broad distribution often have spores tolerant to long storage and temperature extremes. The correlation between distributional area and spore tolerance may be underlined by additional habitat correlates such as the substrate. In the case of *H. velenovskyi*, it is strictly restricted to the specific habitat of loess cliffs (e.g. Pócs, 1999; Pócs *et al.*, 2002; Pócs *et al.*, 2004; Kürschner and Wagner, 2005). A low variability of genetic data for *Bryum argenteum* Hedw. and *Ceratodon purpureus* (Hedw.) Brid. reveal large-scale population structure, suggesting frequent long-distance dispersal in these species (Miller and McDaniel, 2004). This is not the case in *H. velenovskyi*.

All other European populations are more or less related. The population tested from Vojvodina (Serbia) shows great similarity with south Hungarian population, while the north Hungarian population clusters with the population from East Germany. Two German populations are clearly genetically distinct and of different origin.

The results obtained for the selected *Isothecium holtii* populations show that there is high genetic variation among them. This might be a result of lacking gene exchange caused by sterility of the populations and might reflect the scattered distribution of the species and the fact that we have even within the main range no real closed range but several isolated occurrences instead.

The tree shows that all three species, *I. holtii*, *I. myosuroides* and *I. alopecuroides* are well separated. *Isothecium holtii* is rooted together with *I. myosuroides*, thus showing a closer relationship to the latter than to *I. alopecuroides*. The analysis revealed that *Isothecium holtii* is a good species and not a variety as suggested by previous

authors. The closer relationship of *I. holtii* to *I. myosuroides* compared to *I. alopecuroides* is in accordance with the opinion of older authors such as Mönkemeyer (1927) and Nyholm (1954 ff.). However, the molecular evidence is in contrast to its morphology, as *I. holtii* resembles more *I. alopecuroides* in its robust appearance and leaf shape.

The populations of *I. holtii* from the Harz Mountains are from two different valleys. Interestingly, both are neither identical nor do they cluster in one branch but group together with populations from Ireland and Wales. This indicates two different dispersal events by spores from Western Europe probable. The French populations in Brittany and the Massif Central root together and thus seem to be of a common origin. They also root together with the populations in Britain and Ireland, which indicates that gene exchange sometimes in the past. The two populations of *I. holtii* from the Eifel Mountains (Rurtal near Aachen) in Germany are basal to and isolated from all other studied populations of *I. holtii*. This pattern favours the hypothesis these populations are a relict of a previous wider distribution in Western and Central Europe.

The results of our study indicate that both the relict and the dispersal hypothesis may account for the occurrences of *I. holtii* in continental Europe. The Harz-German populations clustering with those from Western Europe are consistent with a hypothesis of relatively recent dispersal. These are the easternmost populations in Germany, and may never have been part of a continuous range in earlier climatic periods. Our data indicate that long-range dispersal is possible in this species, despite lack of vegetative propagation and rare sporophyte production. These considerations are supported with the fact that this species was recently found in Morocco and Turkey.

According to molecular data from selected populations of *Rhytidium rugosum* it seems to be that central Spanish populations are long time isolated from other south

European populations, and that these populations have been established during Pleistocene but did not spread in the Holocene. The Northern Spanish populations are related with populations from the Pyrenées, adjacent regions and the Western European Alps. The Eastern European Alps population has a sister population in the continuing range of the Dinaric Alps. The Serbian populations are clustered with Bulgarian population and form the Central Balkan group.

In France, there are two groups of haplotypes expressing potential migration routes from the Pyrenees and Switzerland. The Western German populations comprise three quite different haplotypes expressing the possibility of west European refugia of *R. rugosum*. However, due to the high variability and quick evolution in the nrITS region used in these study, the absence of sexual reproduction and gene flow this refugial consideration should be drawn carefully since there was the highest sampling resolution in Western Germany, which makes any explanation more difficult.

Generally, where genomes from two or more refugia come together, the genetic diversity will be increased by the presence of diverged survived lineages, as seen in hybrid and suture zones. Two populations with no inbreed event, living in the same region in similar habitats, but from different colonizing refugia will possess very different alleles and genomes, while conversely two very distant populations in distinct habitats may have the same refugial genome. This points to the importance of population history in the process of postglacial adaptation, and our understanding of it. So, it can be considered that western Germany has relic populations as well as ones lately settled during their migrations from southern refugia. Also, there is molecular evidence that some parts of Germany were so called northern refugia for some other groups of organisms (e.g. Hänfling *et al*, 2002; Pinceel, 2005). Besides, some regions like Belgian Ardennes, SW England, NE Hungary, SW Ireland, NW Scotland and W Slovakia are known as cryptic refugia (Stewart & Lister, 2001) where

also fossil evidence suggests survival of some tree and mammal species. These might hypothetically places for survival of some moss populations, as well.

The populations from European Russia according to nr ITS all derives from the refugial site situated in Caucasus region.

The Balkan populations provided a main genomic source for postglacial colonisations, probably due to the deep canyon passes directed south-north. Less came from Iberia and Italy probably hindered by the ice-capped and hardly to pass Pyrenées and Alps (Hewitt, 2004).

Many European species phylogeographies are emerging and a considerable number broadly show these distribution patterns and probably followed similar colonization routes despite differences in their niche, mobility and life history. This apparent and remarkable commonality would seem to be a result of colonization following postglacial climate change in Europe's particular geography of southern peninsulas, transverse mountain ranges and northern plains. It demonstrates the explanatory power of combined phylogeography and paleoclimatology.

During the Last Glacial Maximum (23-18 kyr) the ice sheets and permafrost extended towards lower latitudes, so that species ranges were compressed toward the equator. The boreal species survived south of the ice in North America and Europe, but large areas of the north eastern Palearctic and Beringia remained ice free and some cold-hardy species appear to have survived here. Temperate species survived further south, where habitats occurred to which they were already adapted. In Europe the disjunct southern peninsulas of Iberia, Italy and Balkans were particularly important, while in North America many temperate locations occurred around 40°N between the East and West coasts (Hewitt, 2004b). All this is in accordance with our data for the moss *R. rugosum*.

As a consequence, the habitats of many boreal, temperate and tropical species were reduced and fragmented and they survived in refugia; but for some their habitats expanded, like those from the tundra and savannah. As the climate warmed up after the latest glacial maximum and the ice retreated, many boreal and temperate species were able to expand their ranges, as were some tropical species. In some cases the refugial populations died out, but particularly in mountainous regions they could survive by ascending with the climate and their niche, as for example in the Alps, Andes, Appalachians and Arusha mountains. Such refugial regions allow the survival of species through several ice age cycles by ascending and descending to track their habitat, e.g. (Hewitt, 2000).

Distribution dynamics caused by glaciation-interglaciation cycling events modify the genetic content and structure of populations within species, and leave some traces for which we may search. Populations, races and subspecies that have been effectively separated for several glacial cycles will show divergence through the accumulation of neutral and possibly selected DNA changes. The extent of this divergence will be proportional to the time of separation. The haplotype tree or network of an evolving DNA sequence will reflect population expansions and contractions.

The contractions, expansions and distant colonisations involved in these late Quaternary range changes would have influenced the genetic diversity, and should have left some signs. Low haplotype diversity and shallow clades are expected when populations have been severely contracted, and the age of the subsequent expansion may be gauged by mismatch analysis. The structure of haplotype networks and nested clades also provide indications of such events. So, having all this in mind combined with our molecular data it can be said that the moss species *R. rugosum* survived the last periods during glaciation in various places in Europe and extended its ranges from these places more than once and that survived populations

mixed without exchanging genetical material which is in accordance with its asexual reproduction.

The amphi-atlantic ranged rare riparian species *Dichelyma capillaceum* occurs only once in Germany. Considering the results obtained, it can be assumed that the German population is long time genetically separated from all the others tested. This can be explained by the long geographical isolation and non-sexual reproduction. The German population survived *in situ* or is asexually spread from some other site within the wider but disjoint range of this species.

Considering that the German population shows a different genotype from the American ones, and is slightly different but genetically distant from Scandinavian populations, it can be assumed that it originated from the Scandinavian one and that its expansion has occurred relatively recently with respect to its sterility, German population size and no propagules for short or long distance dispersal. Having in mind that species inhabit riparian habitats over its range and that in the North America it ranges from boreal till subtropical climate zones, it can be assumed that Scandinavian representatives probably have its ancestors in America, where the centre of the range for the genus *Dichelyma* is. Since, German population has different genotype and is according to the branch length relatively long separated from the Scandinavian populations to which is related, it can be assumed that German population is isolated from Scandinavian for over 100 years since the time of its establishment. The species is known to have small spores, it is not excluded that the long distance dispersal has occurred with the spores once upon a time when the sporophyte production was still common.

The frequent major climatic oscillations in the last 2 My caused repeated changes in the ranges of surviving taxa, with extensive extinction and recolonization in higher latitudes and altitudinal shifts and complex refugia nearer the tropics. As a result of these past dynamics, the genetic diversity within species can be highly structured

spatially, with a patchwork of genomes divided by often coincident hybrid zones. When asexual spreading occurs this cannot be expected in such a high rate. The phylogeographical analysis of moss species populations selected in these studies reveals an intriguing picture of the colonization history of mosses in Europe. According to the biology of species examined they survived as well in few other glacial refuges in southern, western and/or Central Europe. From these refuges, major lineages re-colonised Europe in separate directions. According to the molecular data, the Iberian Peninsula and the Balkans were ones of the European southern refuge site. The genetical structure of the moss population examined show that the Pyrenees range together with the Western Alps, show high genetical similarity, while the Eastern Alps population is more related with the Dinaric Alps population, which is not so close to Central Balkan populations group. The data analysed showed that among asexual moss species there are high genetical diversity and high genetic distance are present. However, the geographically distant populations with low genetic distance inferred from molecular give the evidence that long-distance dispersal among bryophytes are presented more often presented event than previously predicted even where there no obvious propagules are produced and where there are no obvious vectors for long distance spreading.

5.0. CONCLUSIONS

From the molecular data obtained, from the dispersal strategies of the species and from the geographical interpretations, the following conclusions can be drawn:

1. Both, long distance dispersal and relicts are responsible for the present distribution of the species studied.
2. The basal position of the southern and western European populations in species like *Campylopus oerstedianus* and *Isothecium holtii* supports the refugial hypothesis during the last Ice Age, from which the species established populations in Central Europe by long distance dispersal. The site of *Dichelyma capillaceum* in Germany has originated from the Scandinavian population by long distance dispersal, too.
3. In case of *Hilpertia velenovskyi* and *Rhytidium rugosum*, persistence during and since the last Ice Age in Central Europe can be postulated.

Long-distance dispersal is possible in the species studied, although they are sterile at present and lack specialized brood bodies. It can only be explained by the fact that fragments of plants can serve even for long distance dispersal.

6.0. SUMMARY

Disjunct ranges are a common phenomenon in bryophytes. To test, whether these disjunctions are the result of the former continuous ranges (and therefore relicts) or the result of long-distance dispersal (and therefore result of spreading), five moss species were chosen for a case study: *Campylopus oerstedianus*, *Hilpertia velenovskyi*, *Isothecium holtii*, *Rhytidium rugosum* and *Dichelyma capillaceum*

Also, the problem of genetic diversity within the species morphologically not very variable species in space and time has been studied.

For the determination of genetic distances between populations, the variation of the nuclear ribosomal non coding DNA region of the Internal Transcribed Spacer (ITS) and *trnL-F* region of the chloroplast DNA was used.

Campylopus oerstedianus has a scattered circum tethyan distribution ranging from Costa Rica to Georgia, the Pyrenees, the Southern Alps and northern Greece. It is worldwide sterile and can propagate only vegetatively. In addition it is found in the Massif Central and the Vosges, in France. The molecular results showed that the populations in the Pyrenees, Southern Alps and Greece have no genetic exchange and are possibly separated for long time. The disjunct populations in France are clustering with the population in the Pyrenees and are therefore possibly derived from the latter. The Greek population is highly isolated and genetically unrelated to the other European populations of *C. oerstedianus*, which counts for a very long isolation.

Hilpertia velenovskyi is mainly a species of cold loess steppes in inner Asia. It is also found in Europe on loess cliffs from southern Poland to northern Serbia. It was recently discovered in Germany (Saxony and Rhinehessia). The molecular tree shows that Saxonian population is related to the Czech and both cluster with all other

European populations except that from Rhinehessia. The latter is totally isolated also from a Chinese one, which means that it has spread from somewhere else, probably from some populations, which were not included in the study, or it has to be interpreted as a result of long lasting isolation since the last Ice Age. The continuity of the habitat (loess cliff), however support this hypothesis. It would be the first molecular proof of a glacial relict among bryophytes.

Isothecium holtii has been regarded either as good species, dubious species, or as a variety of either *I. alopecuroides* or *I. myosuroides*. Its distribution range includes the British Isles, western France and western Norway, with disjunct occurrences in Central Europe and Turkey. A molecular study was designed to clarify the taxonomic position of this taxon as well as to assess whether the disjunct populations in Germany are a result of recent migration or whether they are relicts of a wider distribution in more humid climatic periods. The analysis of nuclear ribosomal DNA sequences (ITS) revealed that *Isothecium holtii* is a good species, and that it is closer related to *I. myosuroides* than to *I. alopecuroides*. The disjunct populations in Germany are heterogenous. Two from the Harz Mts. cluster with different populations in Western Europe, indicating independent dispersal events, whereas another from the Eiffel Mts. is genetically isolated, indicating a long separation and a relict. The populations in Brittany and the Massif Central in France are genetically related but rooted with the populations from Britain and Ireland and indicate that they are relicts of a former continuous range.

The boreal moss *R. rugosum*, today widely but scattered spread over Europe, is considered to be a glacial relict of its wide but scattered Holarctic range. Due to molecular data, it survived glaciation in southern European refugia, but also in some regions of central and Western Europe. According to haplotypes distinguished in Europe, the species range is a result of migrations, range extension, colonization and spreading events. However, some relic haplotypes remain within some regions of

Europe. The species extremely rarely produces spores and spreads mainly vegetatively. The geographical regions of higher genetic diversity among populations can be the regions where some relic haplotypes survived and afterwards were settled by some other haplotypes during migrations, as well. South-western and western Germany is determined as one of these regions in Europe. According to molecular data sampled from selected European, American and Asian populations, a high genetic diversity of this species is present although it is mostly sterile.

Dichelyma capillaceum is a rare and protected pleurocarpous moss from riparian habitats with scattered amphi-atlantic distribution. The European center of its distribution is concentrated within Scandinavia with 85 populations mostly in Sweden. Outside Scandinavia two further populations are still present in Europe (in W. Germany and NW France). It is sterile although there are a few rare old records with sex organs or sporophyte from herbaria.

The German population of *D. capillaceum* is genetically long time separated but originated from some ancestor from Scandinavia. According to the genetical data obtained it is rather result of relatively recent long distance dispersal event than of relict origin. Due to bio-geographical and molecular data, it can be assumed that the Scandinavian populations derived from North American. This can be proved by the fact that genetic variation among European populations studied is lower compared to all studied populations, which means a longer existence of American populations. It is furthermore supported by the fact that Atlantic North America is centre of species diversity of the genus *Dichelyma*.

From the molecular data obtained, from the dispersal strategies of the species and from the geographical interpretations, the following conclusions can be drawn:

4. Both, long distance dispersal and relicts are responsible for the present distribution of the species studied.

5. The basal position of the southern and western European populations in species like *Campylopus oerstedianus* and *Isothecium holtii* supports the refugial hypothesis during the last Ice Age, from which the species established populations in Central Europe by long distance dispersal. The site of *Dichelyma capillaceum* in Germany has originated from the Scandinavian population by long distance dispersal, too.
6. In case of *Hilpertia velenovskyi* and *Rhytidium rugosum*, persistence during and since the last Ice Age in Central Europe can be postulated.
7. Long-distance dispersal is possible in the species studied, although they are sterile at present and lack specialized brood bodies. It can only be explained by the fact that fragments of plants can serve even for long distance dispersal.

7.0. ACKNOWLEDGEMENTS

I wish to express my gratitude to Prof. Dr. Jan-Peter Frahm for the guidance through multidisciplinary approach to bryology and for the persistency and support he gave me over last years.

Furthermore, I greatly appreciate to Dr. Barthlott, Dr. Litt and Dr. Löffler for taking the Korreferat.

I acknowledge indeed the DAAD and GEFFRUB for financial support, without which I would not be able to bring my PhD work till the end.

Sincere thanks to many colleagues from Nees Institute of Bonn University, especially to co-workers in Molecular Laboratory and to Prof. Dr. V. Knoop (Institute of Cell and Molecular Botany of Bonn University) for his support.

Also, I thank to the colleagues from my home University of Belgrade.

I am grateful to all the colleagues, which provide material for molecular study.

Last but not least, I wish to express my thankfulness to my Aneta, my family and my friends who were with and by me in my good and bad.

8.0. REFERENCES

- Aguilar, J.F., Rosselló, J.A. and Feliner, G.N. 1999a. Molecular evidence for the compillopecies model for reticulate evolution in *Armeria* (Plumbaginaceae). *Systematic Biology* 48: 735–754.
- Aguilar, J.F., Rosselló, J.A. and Feliner, G.N. 1999b. Nuclear ribosomal DNA (nrDNA) concerted evolution in natural and artificial hybrids of *Armeria* (Plumbaginaceae). *Molecular Ecology* 8: 1341–1346.
- Ainouche A.-K. and Bayer R.J. 1999. Phylogenetic relationship in *Lupinus* (Fabaceae: Papilionidae) based on internal transcribed spacer sequences (ITS) of nuclear ribosomal DNA. *American Journal of Botany* 86: 590-607.
- Akaike, H. 1974. A new look at the statistical model identification. *IEEE Transaction Autom. Contribution* 19: 716-723.
- Allorge, V. and Jovet-Ast, S. 1948. *Dichelyma capillacea* dans le sud-ouest de la France. *Compte rendu sommaire des séances de la société de biogéographie* 25(213): 17-18.
- Andreasen, K. and Baldwin, B.G. 2001. Unequal evolutionary rates between annual and perennial lineages of checker mallows (*Sidalcea*, Malvaceae): Evidence from 18S-26S rDNA internal and external transcribed spacers. *Molecular Biology and Evolution* 18(6): 936-944.
- Arnheim, N. 1983. Concerted evolution of multigene families. – In: Nei, M. and Koehn, R.K. (Eds.), *Evolution of genes and proteins*. Sinauer Assoc., Sunderland, Massachusetts, USA. Pp 38-61.
- Arnheim, N., Krystal, M., Schmickel, R., Wilson, G., Ryder, O and Zimmer, E.A. 1980. Molecular evidence for genetic exchanges among ribosomal genes on non-homologous chromosomes in man and apes. *Proceedings of the National Academy of Sciences USA* 77: 7323-7327.

- Ashworth, A.C. 1996. The response of arctic Carabidae (Coleoptera) to climate change based on the fossil record of the Quaternary Period. *Annales Zoologici Feniici* 33: 125-131.
- Avise, J.C. 1998. The history and purview of phylogeography: a personal reflection. *Molecular Ecology* 7: 371–379.
- Avise, J.C. 2000. *Phylogeography: The History and Formation of Species*. Harvard University Press, London
- Avise, J.C., Arnold, J., Ball, R. M., Bermingham, E., Lamb, T., Neigel, J. E., Reeb, C. A. and Saunders, N. C. 1987. Intraspecific phylogeography: The mitochondrial DNA bridge between population genetics and systematics. *Annual Review of Ecology and Systematics* 18: 489-522.
- Axelrod, D.I. 1975. Evolution and biogeography of Madrean-Thetyan sclerophyll vegetation. *Annals of the Missouri Botanical Garden* 62: 280-334.
- Bachmann, K. 1997. Nuclear DNA markers in plant biosystematic research. *Opera Botanica* 132: 137–148.
- Bai, X.-L., 1987 - Primary report of the mosses in Inner Mongolia, China. *Acta Scientiarum Naturalium Universitatis Intramongoliae* 18: 311-350.
- Baldwin, B.G. 1992. Phylogenetic utility of the internal transcribed spacers of nuclear ribosomal DNA in plants: and examples from the Compositae. *Molecular Phylogenetics and Evolution* 1: 3–16.
- Baldwin, B.G. 1993. Molecular phylogenetics of *Calycadenia* (Compositae) based on ITS sequences of nuclear ribosomal DNA: chromosomal and morphological evolution reexamined. *American Journal of Botany* 80: 222 – 238.
- Baldwin, B.G. and Markos, S. 1998. Phylogenetic utility of the external transcribed spacer (ETS) of 18S-26S rDNA: congruence of ETS and ITS trees of *Calycadenia* (Compositae). *Molecular Phylogenetics and Evolution* 10: 449-463.
- Baldwin, B.G. and Sanderson, M.J. 1998. Age and rate of diversification of the Hawaiian silversword alliance (Compositae). *Proceedings of the National Academy of Science of the USA* 95: 9402-9406.

- Baldwin, B.G., Sanderson, M.J., Porter, J.M., Wokciechowski, M.F., Campbell, C.S. and Donoghue, M.J. 1995. The ITS region of nuclear ribosomal DNA: a valuable source of evidence on angiosperm phylogeny. *Annals of the Missouri Botanical Garden* 82: 247-277.
- Barker, N.P., Muller, E.M. and Mill, R.R. 2004. A yellowwood by any other name: molecular systematics and the taxonomy of *Podocarpus* and the Podocarpaceae in Southern Africa. *South African Journal of Science* 100: 629-632.
- Barker, N.P., von Senger, I., Howis, S., Zachariades, C. and Ripley, B.S. Plant phylogeography based on rDNA IST sequence data: two examples from Asteraceae. – In: Bakker, F. T., Chatrou, L. W., Gravendeel, B. and Pelsers, P. B. (Eds.) *Plant Species level systematics – patterns, processes and new applications*. Koeltz, Königstein. Pp. 217-244.
- Beardmore, J.A., 1983. Extinction, survival and genetic variation. In: Schoenwald-Cox C. M., Chambers S. M., MacBryde B. & Thomas L. (Eds), *Genetics and Conservation*. Benjamin-Cummings, Menlo Park, CA, pp. 125-151.
- Beckert, S., Steinhauser, S., Muhle, H. and Knoop. V. 1999. A molecular phylogeny of bryophytes based on nucleotide sequences of the mitochondrial *nad5* gene. *Plant Systematics and Evolution* 218 (3-4): 179-192.
- Belland, R.J., Schoefield, W.B. and Hedderson, T.A. 1992. Bryophytes of Mingan Archipelago National Park Reserve, Québec: A boreal flora with arctic and alpine components. *Canadian Journal of Botany* 70: 2207-2222.
- Bena, G., Prosperi, J.-M., Lejeune, B. and Olivieri, I. 1998. Evolution of annual species of the genus *Medicago*: A molecular phylogenetic approach. *Molecular Phylogenetics and Evolution* 9: 552-559.
- Benn, D.I. and Evans, J.A. 1998. *Glaciers and glaciation*. Publisher Arnold, London, pp.734.
- Bennett, K.D. 1997. *Evolution and Ecology: The Pace of Life*. Cambridge University Press, Cambridge

- Bennett, K.D., Tzedakis, P.C. and Willis, K.J. 1991. Quaternary refugia of north European trees. *Journal of Biogeography* 18:103–115.
- Berger, A. 1988. Milankovitch theory and climate. *Reviews of Geophysics* 26: 624–657.
- Bermingham, E. and Moritz, C. 1998. Comparative phylogeography: concepts and applications. *Molecular Ecology* 7: 367-369.
- Bernardi G., Mouchiroud D. and Gautier C. 1988. Compositional patterns in vertebrate genomes: Conservation and change in evolution. *Journal of Molecular Evolution* 28: 7-18.
- Bernardi, G., Findley, L. and Rocha-Olivares, A. 2003. Vicariance and dispersal across Baja California in disjunct marine fish populations. *Evolution* 57: 1599-1609.
- Bernatchez, L. 2001. The evolutionary history of the brown trout (*Salmo trutta*) inferred from phylogeographic, nested clade and mismatch analyses of mitochondrial DNA variation. *Evolution* 55: 351-379.
- Besendahl, A., Qui, Y.-L., Lee, J., Palmer, J.-D. and Bhattacharya, D. 2000. The cyanobacterial origin and vertical transmission of the plastid tRNA_{LEU} group I intron. *Current Genetics* 37: 12-23.
- Bischler, H and Boisselier-Dubayle, M.C. 1997. Population genetics and variation in liverworts. *Advances in Bryology* 6: 1-34.
- Blanár, D. and Šoltés, R. 2000. The glacial relict moss species *Helodium blandowii* in the Veporské vrchy Hills (Slovakia). *Thaiszia* 10: 47-51.
- Blattner, F.R. 1999. Direct amplification of the entire ITS region from poorly preserved *ülants* using recombinant PCR. *BioTechniques* 27: 1180-1186.
- Bonn, S. and Poschold, P. 1998. *Ausbreitungsbiologie der Pflanzen Mitteleuropas*. Wiesbaden, Quelle and Meyer.
- Boros, A., 1944. Florisztikai érdekességek a Bácskából. *Botanikai Közlemények* XLI: 1-2.

- Borsch, T., Hilu, W., Quandt, D., Wilde, W., Neinhuis, C. and Bartlott, W. 2003. Non encoding plastid *trnT-trnF* sequences reveal a well resolved phylogeny of basal angiosperms. *Journal of Evolutionary Biology* 16: 558-576.
- Bouchard, A., Barabé, D. and Hay, S. 1977. An isolated colony of *Oropteris limbosperma* (ALL.) Holub in Gros Morne National Park, Newfoundland, Canada. *Naturaliste canadienne* 104: 239-244.
- Bowers, M.A. and Harris, L.C. 1994. A large-scale metapopulation model of interspecific competition and environmental change. *Ecological Modelling* 72: 251–273.
- Brasch, H. 1923. Beitrag zur Laubmoosflora. Sitzungber. *Naturhist. Ver. Preuss. Rheinlande und Westfalen* 1920-22: 18-22.
- Breil, D.A. and Moyle, S.M. 1976. Bryophytes used in construction of bird nests. *Bryologist* 79: 95-98.
- Bremer, P. and Ott, E.C.J. 1990. The establishment and distribution of bryophytes in the woods of IJsselmeerpolders, The Netherlands. *Lindbergia* 16: 3-18.
- Brouillet, L., Hay, S., Turcotte, P. and Bouchard, A. 1998. La flore vasculaire alpine du Plateau Big level, au Parc National du Gros-Morne, Terre-Neuve. *Géographie physique et Quaternaire* 52 (2): 1-19.
- Brown, J.H. 1995. *Macroecology*. University Chicago Press, Chicago.
- Buck, W.R., Goffinet, B. and Shaw, A. 2000a. Testing morphological concepts of orders of pleurocarpous mosses (Bryophyta) using phylogenetic reconstruction based on *trnL-F* and *rps4* sequences. *Molecular Phylogeny and Evolution* 16: 180-198.
- Buck, W.R., Goffinet, B. and Shaw, A. 2000b. Novel relationships in pleurocarpous mosses as revealed by cpDNA sequences. *Bryologist* 103: 774-789.
- Bunje, P.M.E. 2005. Pan-European phylogeography of the aquatic snail *Theodoxus fluviatilis* (Gastropoda: Neritidae). *Molecular Ecology* 14: 4323-4340.
- Cain, M.L., Milligan, B.G. and Strand, A. E. 2000. Long-distance seed dispersal in plant populations. *American Journal of Botany* 87:1217–1227.

- Cardoso, M.A., Provan, W., Powell, J., Ferreras, P.C.G. and Oliveira, D.E. 1998. High genetic differentiation among remnant populations of the endangered *Caesalpinia echinata* Lam. (Leguminosae-Caesalpinioideae). *Molecular Ecology* 7: 601-608.
- Chalmers, K.J., Waugh, R., Sprent, J.I., Simons, A.J. and Powell, W. 1992. Detection of genetic variation between and within population of *Gliricidia sepium* and *G. maculata* using RAPD markers. *Heredity* 69: 465-472.
- Chiang, T.Y. and Schaal, B.A. 1999. Phylogeography of North American populations of the moss species *Hylocomium splendens* based on the nucleotide sequences of the internal transcribed spacer 2 of nuclear ribosomal DNA. *Molecular Ecology* 8: 1037-1042.
- Chiang, T.Y., Chiang, Y.C., Chen, Y.J., Chou, C.H., Havonond, S., Hong, T.N. and Huang, S. 2001. Phylogeography of *Kandelia candel* in East Asiatic mangroves based on nucleotide variation of chloroplast and mitochondrial DNAs. *Molecular Ecology* 10: 2697-2710.
- Clegg, M.T., Gaut, B.S., Learn, G.H. and Morton, B.R. 1994. Rates and patterns of chloroplast DNA evolution. *Proceedings of the National Academy of Sciences, USA* 91: 6795-6801.
- Clevinger, J.A. and Panero, J.L. 2000. Phylogenetic analysis of *Silphium* and Subtribe Engelmanniinae (Asteraceae: Helianthae) based on ITS and ETS sequence data. *American Journal of Botany* 87: 565 – 572.
- Collevatti, R.G., Grattapaglia, D. and Hay, J.D. 2003. Evidences for multiple maternal lineages of *Caryocar brasiliense* populations in the Brazillian Cerrado based on the analysis of chloroplast DNA sequences and microsatellite haplotype variation. *Molecular Ecology* 12: 105-115.
- Cook, L. M., Soltis, P.S., Brunfeld, S.J. and Soltis, D.E. 1998. Multiple independent formations of *Tragopogon* tetraploids (Asteraceae): evidence from RAPD markers. *Molecular Ecology* 7: 1293 – 1302.
- Coope, G.R. 1979. Late Cenozoic fossil Coleoptera: evolution, biogeography, and ecology. *Annual Review of Ecology and Systematics* 10:247–267.

- Cronberg, N. 1998. Population structure and interspecific differentiation of the peat moss sister species *Sphagnum rubellum* and *S. capillifolium* (*Sphagnaceae*) in northern Europe. *Plant Systematics and Evolution* 209: 139-158.
- Cronberg, N. 2000. Genetic diversity of the epiphytic bryophyte *Leucodon sciuroides* in formerly glaciated versus nonglaciated parts of Europe. *Heredity* 84: 710-720.
- Cronberg, N. 2002. Colonization dynamics of the clonal moss *Hylocomium splendens* on islands in a Baltic land uplift area: reproduction, genet distribution and genetic variation. *Journal of Ecology* 90: 925-935.
- Cronberg, N., Molau, U. and Sonesson, M. 1997. Genetic variation in the clonal bryophyte *Hylocomium splendens* at hierarchical geographical scales in Scandinavia. *Heredity* 78: 293-301.
- Cronberg, N., Rydgren, K. and Okland, R.H. 2006. Clonal structure and genet-level sex ratios suggest different roles of vegetative and sexual reproduction in the clonal moss *Hylocomium splendens*. *Ecography* 29: 95-103.
- Cronin, T.M., Raymo, M.E. and Kyle, K.P. 1996. Pliocene (3.2–2.4 Ma) ostracode faunal cycles and deep ocean circulation, North Atlantic Ocean. *Geology* 24: 695–698
- Cronk, Q.C.B. 1997. Islands: stability, diversity, conservation. *Biodiversity and Conservation* 6: 477–493.
- Cros, R.M. 2001. Nuevas citas de *Campylopus oerstedianus* y *C. brevopilus* para la flora española. *Boletín de Sociedad Española de Briología* 18-19: 73-76.
- Crum, H.A. and Anderson, L.E. 1981. Mosses of Eastern North America, Columbia University Press, New York, 2 vol. 1328.
- Cruzan, M.B. and Templeton, A.R. 2000. Paleogeography and coalescence: phylogeographic analysis of hypotheses from the fossil record. *Trends in Ecology and Evolution* 15: 491–496.
- Cullings, K.W. and Vogler, D.R. 1998. A 5.8S nuclear ribosomal RNA gene sequence database: applications to ecology and evolution. *Molecular Ecology* 7: 919-923.

- Cwynar, L.C. and MacDonald, G.M. 1987. Geographical variation of lodgepole pine in relation to population history. *American Naturalist* 129: 463–469.
- Darlington, P.J. 1943. Carabidae of mountains and islands: data on the evolution of isolated faunas, and on atrophy of wings. *Ecological Monograph* 13: 37–61.
- Davis, M.B. 1976. Pleistocene biogeography of temperate deciduous forests. *Geoscience and Man* 8:13-26.
- Davis, M.B. and Shaw, R.G. 2001. Range shifts and adaptive responses to Quaternary climate change. *Science* 292: 673-679.
- Davison, G.W.H. 1976. Role of birds in moss dispersal. *British birds* 69: 65-66.
- De Luna, E., Buck, W.R., Akiyama, H., Arikiwa, T., Tsubota, H., Gonzalez, D., Newton, A.E. and Shaw, A.J. 2000, Ordinal phylogeny within the Hypnobryalean pleurocarpous mosses inferred from cladistic analyses of the tree chloroplast DNA sequence data sets: *trnL-F*, *rps4* and *rbcL*. *Bryologist* 103: 242-256.
- De Zuttere, Ph. and Sotiaux, A. 1985. Quelques bryophytes nouvelles ou intéressantes pour les Vosges francaises. *Bulletin Soc. Hist. Nat. Montbéliard* 1985: 48-51.
- De Zuttere, Ph., Quéré, Ph., Durfort, J. and Pohl, H. 1998. Récoltes bryologiques en Bretagne (III). *Nowellia bryologica* 15-16: 15-48.
- Demesure, B., Sodzi, N. and Petit, R.J. 1995. A set of universal primers for amplification of polymorphic non-coding regions of mitochondrial and chloroplast DNA in plants. *Molecular Ecology* 4: 129-131.
- Demesure, B., Comps, B. and Petit, R.J. 1996. Chloroplast DNA phylogeography and the common beech (*Fagus sylvatica* L.) in Europe. *Evolution* 50: 2515-2520.
- Dia, M.G. 2000. First record of *Campylopus oerstedianus* (Dicranaceae, Musci) in Sicily. *Flora Mediterranea* 10: 81–85.
- Dia, M.G., Miceli, G. and Raimondo, F. M. 1987. Check-list dei muschi noti in Sicilia. *Webbia* 41: 61-123.
- Dickson, J. H. 1973. Bryophytes of the Pleistocene. The British record and its chorological and ecological implications. Cambridge University Press, London.

- Dítě, D. and Šoltés, R. 2002. Nová lokalita glaciálnych reliktov machorastov v Blatnej doline (Podtatranská brázda, Slovensko). (New location of glacial moss relict species in Blatná dolina (Podtatranská brázda, Slovakia)). *Bulletin of the Slovakian Botanical Society* 24: nn
- Dow, B.D. and Ashley, M.V. 1996. Microsatellite analysis of seed dispersal and parentage of saplings in bur oak, *Quercus macrocarpa*. *Molecular Ecology* 5: 615-627.
- Dowling, T.E., Moritz, C., Palmer, J.D. and Riesberg, L.H. 1996. Nucleic Acid III: Analysis of fragments and restriction sites. – In: Hillis, D. M. Moritz, C. and Mable, B.K. (Eds.) *Molecular Systematics*. Sunderland, Mass. Sinauer Associates, Inc. Pp. 249-320.
- Downie, S.R. and Palmer, J.D. 1992. Use of chloroplast DNA rearrangements in reconstructing plant phylogeny. - In: Soltis, P.S., Soltis, D.E. and Doyle, J.J. (Eds.) *Molecular Systematics of Plants*. New York, Chapman & Hall. Pp14-35
- Doyle, J.J. 1995. The irrelevance of allele tree topologies for species delineation, and non-topological alternatives. *Systematic Botany* 20: 574 – 588.
- Doyle, J.J. 1997. Within trees: genes and species, molecules and morphology. *Systematic Biology* 46: 537-553.
- Doyle, J.J. and Doyle, J.L. 1990. Isolation of DNA from fresh tissue. *Focus* 12: 13-15.
- Doyle, J.J., Kanazin, V. and Schoemaker, R.C. 1996. Phylogenetic utility of Histone H3 intron sequences in the perennial relatives on the soybean (*Glycine*: Subg. *Glycine*: Leguminosae). *American Journal of Botany* 83: 434.
- Doyle, J.J., Doyle, J.L. and Brown, A.H.D. 1999. Origins, colonization, and lineage recombination in a widespread perennial soybean complex. *Proceedings of the National Academy of Sciences, USA* 96: 10741-10745.
- Düll, R. 1980. Die Moose (Bryophyta) des Rheinlandes (Nordrhein-Westfalen, BRD) *Decheniana Beiheft* 24.
- Düll, R. 1994. *Deutschlands Moose*. Bad Münstereifel.
- Düll, R., Koppe, F. and May, R. 1996. *Punktkartenflora der Moose Nordrhein-Westfalens*. - Bad Münstereifel.

- Dumolin-Lapègue, S., Demesure, B., Fineschi, S., Le Corre, V. and Petit, R.J. 1997. Phylogeographic structure of white oaks throughout the European continent. *Genetics* 146: 1475-1487.
- During, H.J., 1997.- Bryophyte diaspore banks. *Advances in Bryology* 6: 103-134.
- Dynesius, M. and Jansson, R. 2000. Evolutionary consequences of changes in species' geographical distributions driven by Milankovitch climate oscillations. *Proceedings of the National Academy of Sciences, USA* 97:9115–9120
- ECCB, 1995. *Red Data Book of European bryophytes*. Trondheim.
- El Mousadik, A. and Petit, R.J. 1996. Chloroplast DNA phylogeography of the argan tree of Morocco. *Molecular Ecology* 5: 547-555.
- Ellstrand, N.C. and Schierenbeck, K.A. 2000. Hybridisation as a stimulus for the evolution of invasiveness in plants? *Proceedings of the National Academy of Sciences, USA* 97: 7043-7050.
- Emshwiller, E. and Doyle, J.J. 1999. Chloroplast-expressed Glutamine Synthetase (npsGS): potential utility for phylogenetic studies with an example from *Oxalis* (Oxalidaceae). *Molecular Phylogenetics and Evolution* 12: 310-319.
- Ennos, R.A. 1994. Estimating the relative rates of pollen and seed migration among plant populations. *Heredity* 72: 250-259.
- Farris, J.S. 1970. Methods of computing Wagner trees. *Systematic Zoology* 34: 21-34.
- Farris, J.S. 1989. The retention index and the rescaled consistency index. *Cladistics* 5: 417-419.
- Feld, J. 1958. Moosflora der Rheinprovinz. *Decheniana Beiheft* 6.
- Felsenstein, J. 1985. Confidence limits on phylogenies: An approach using the bootstrap. *Evolution* 39: 783-791.
- Felsenstein, J. 1988. Phylogenies from molecular sequences: inference and reliability. *Annual Review of Genetics* 22: 521-565.
- Fernald, M.L. 1925. The persistence of plants in unglaciated areas of boreal America. *Memoirs of the American Academy of Arts and Sciences* 15: 239-342.

- Ferris, C., Oliver, R.P., Davy, A.J. and Hewitt, G.M. 1993. Native oak chloroplasts reveal an ancient divide across Europe. *Molecular Ecology* 2: 337-344.
- Fitch, W.M. 1971. Toward defining the course of evolution. Minimum change for a specific tree topology. *Systematic Zoology* 20: 406-416.
- Fjeldsa, J., Lambin, E. and Mertens, B. 1999. Correlation between endemism and local ecoclimatic stability documented by comparing Andean bird distributions and remotely sensed land surface data. *Ecography* 22:63–78.
- Flenley, J.R. 1998. Tropical forests under the climates of the last 30,000 years. *Climate Change* 39: 177–197.
- Frahm, J.-P. 1980. Taxonomische Notizen zur Gattung *Campylopus* IX. *Journal of Bryology* 11: 213-218.
- Frahm, J.-P. 1984. Phytogeography of European *Campylopus* Species. Proc. III. Meeting of Bryologists from Central and East Europe, Prague, 191-212.
- Frahm, J.-P. 1988. The subantarctic and southern hemispheric species of *Campylopus* (Dicranaceae), with contribution to the origin and speciation of the genus. *Journal of Hattori Botanical Laboratory* 64, 367-387.
- Frahm, J.-P. 1989. *La bryoflore des Vosges et des zones limitrophes*. Duisburg University.
- Frahm, J.-P. 1999. A type catalogue of Campyloporidioideae and Paraleucobryoideae (Musci, Dicranaceae), Part II, Campylopus. *Tropical Bryology* 16: 17-102.
- Frahm, J.-P. 2000. *Hilpertia velenovskyi* in Rheinhessen. *Limprichtia* 14: 27-30.
- Frahm, J.-P. 2001. *Biologie der Moose*. Gustav Fischer Verlag, Heidelberg-Berlin. Pp. 357.
- Frahm, J.-P. 2002. La bryoflore des Vosges et des zones limitrophes. *Limprichtia* 19: 1- 332.
- Frahm, J.-P. 2003. *Isothecium holtii*, eine verkannte Art. *Bryologische Rundbriefe* 72:4-5.
- Frahm, J.-P. 2005. *Rhytidium rugosum* (Hedw.) Kindb. *Bryologische Rundbriefe* 94: 7.

- Frahm, J-P. and Stapper, N. 1998. Das Laubmoos *Dichelyma capillaceum* nach 70 Jahren an seinem einzigen Fundort in Deutschland gefunden. *Decheniana* 151: 109-113.
- Frankel, O.H. 1983. The place of management in conservation. In: Schoenwald-Cox C. M., Chambers S. M., MacBryde B. & Thomas L. (Eds). *Genetics and Conservation*. Benjamin-Cummings, Menlo Park, CA, pp. 113-121.
- Franklin, E.R. 1980. Evolutionary change in small populations. In: SOULÉ M. E. & Wilcox B. A. (Eds) *Conservation biology: an evolutionary –ecological perspective*. Sinauer, Sunderland, pp.135-150.
- Freitas, H. and Brehm, A. 2001. Genetic diversity of the Macaronesian leafy liverwort *porella canariensis* inferred from RAPD markers. *Journal of Heredity* 92: 339-345.
- Frey, W., Stech, M. and Meissner, K. 1999. Chloroplast DNA relationship in paleoaustral *Lopidium concinnum* (Hypopterygiaceae, Musci). An example of stenoevolution in mosses. *Studies in austral temperate rain forest bryophytes 2. Plant Systematics and Evolution* 218: 67-75.
- Fujii, N., Tomaru, N., Okuyama, K., Koike, T., Mikami, T. and Ueda, K. 2002. Chloroplast DNA phylogeography of *Fagus crenata* (Fagaceae) in Japan. *Plant Systematics and Evolution* 232: 21-33.
- Futuyama, D.J. 1987. On the role of species in anagenesis. *American Naturalist* 130: 465-473.
- Futuyama, D.J., and Moreno, G. 1988. The evolution of ecological specialization. *Annual Review of Ecology and Systematics* 19: 207–233.
- Gams, H. 1932. Quaternary distributions. – In: Verdoorn, P. (Ed.) *Manual of Bryology*. The Hague. Pp. 297-322.
- Gaut, B.S., Muse, S.V., Clark, W.D. and Clegg, M.T. 1992. Relative rates of nucleotide substitution at the *rbcL* locus of monocotyledonous plants. *Journal of Molecular Evolution* 35: 292-303.
- Gerbi, S.A. 1985. Evolution of ribosomal RNA. - In: MacIntyre, R.J. (Ed.) *Molecular Evolutionary Genetics*. New York, Plenum Press. Pp. 419-518

- Gielly, L. and Taberlet, P. 1994a. Chloroplast DNA polymorphism at the intrageneric level and plant phylogenies. *Comptes Rendus de l'Académie des Sciences de Paris* 317: 685-692.
- Gielly, L. and Taberlet, P. 1994b. The use of chloroplast DNA to resolve plant phylogenies: Noncoding vs. *rbcL* sequences. *Molecular Biology and Evolution* 11: 769-777.
- Gielly, L., Debussche, M. and Thompson, J.D. 2001. Geographic isolation and evolution of Mediterranean endemic *Cyclamen*: insights from chloroplast *trnL* (UAA) intron sequence variation. *Plant Systematics and Evolution* 230: 75-88.
- Goertzen, L.R., Cannone, J.J., Gutell, R.R. and Jansen, R.K. 2003. Secondary structure derived from comparative analysis: implications for sequence alignment and phylogeny of the Asteraceae. *Molecular Phylogenetics and Evolution* 29 (2): 216-234.
- Grant, W.F. 1953. A cytotaxonomic study in the genus *Eupatorium*. *American Journal of Botany* 40: 729-742.
- Grivet, D. and Petit, R.J. 2002. Phylogeography of the common ivy (*Hedera* sp.) in Europe: genetic differentiation through space and time. *Molecular Ecology* 11: 1351-1362.
- Gutierrez Larena, B., Fuertes Aguilar, J and Nieto Feliner, G. 2002. Glacial-induced altitudinal migrations in *Armeria* (Plumbaginaceae) inferred from patterns of chloroplast DNA haplotype sharing. *Molecular Ecology* 11: 1965-1974.
- Hamby, R. K. and Zimmer, E.A. 1992. Ribosomal RNA as a phylogenetic tool in plant systematics. - In: Soltis, P.S., Soltis, D.E. & Joyle, J.J. (Eds.) *Molecular Systematics of Plants*. New York, Chapman and Hall. Pp.50-91.
- Hamrick, J.L., Godt, M.J.W., Murawski, D.A. and Loveless, M.D. 1991. Correlation between species traits and allozyme diversity: implication for conservation biology. In: FALK D.A. & HOLSINGER, K. E. (Eds) *Genetics and conservation of rare plants*. Oxford University Press, New York, pp. 75-86.

- Hänfling, B., Hellemans, B., Volckaert, F.A.M. and Carvalho, G.R. 2002. Late glacial history of the cold-adapted freshwater fish *Cottus gobio*, revealed by microsatellites. *Molecular Ecology* 11: 1717-1729.
- Hays, J.D., Imbrie, J. and Shackleton, N.J. 1976. Variations in the Earth's orbit: pacemaker of the ice ages. *Science* 194: 1121-32
- Heinken, T. 2000. Dispersal of plants by a dog. *Botanische Jahrbücher für Systematik* 122: 449-467.
- Heinken, T., Lees, R., Raudnitschka, D. and Runge, S. 2001. Epizoochorous dispersal of bryophyte stem fragments by roe deer (*Capreolus capreolus*) and wild boar (*Sus scrofa*). *Journal of Bryology* 23: 293-300.
- Heintze, A. 1915. Om synzoisk fröspridning genom fåglar. *Svensk Botanisk Tidskrift* 9: 13-22.
- Hendy, M.D. and Penny, D. 1982. Branch and bound algorithms to determine minimal evolutionary trees. *Mathematical Biosciences* 59: 277-290.
- Hennig, W. 1966. *Phylogenetic Systematics*. Uni. Illinois Press, Urbana.
- Hepperle, D. 2002. *Alignment Editor Align*. Heidelberg.
- Hepperle, D. 2003. *Align v01/2003: manual sequence alignment for PCs*. <http://www.gwdg.de/~dhepper/software.htm>
- Hedenäs, L., Godow, S. and Hylander, K. 1996. Bryophyte Profiles No 1: *Dichelyma capillaceum* (Dicks.) Myr. (Bryopsida: Fontinalaceae). *Journal of Bryology* 19: 157-179
- Herzog, Th. 1926. *Geographie der Moose*. Jena (Fischer).
- Heusser, C.J. 1972. Polsters of the Moss *Drepanocladus berggrenii* on Gilkey Glacier, Alaska. *Bulletin of the Torrey Botanical Club* 99 (1): 34-36.
- Hewitt, G.M. 1993. Postglacial distribution and species substructure: lessons from pollen, insects and hybride zones. – In: Leeds, D.R. and Edwards, D. (Eds.) *Evolutionary patterns and processes*. Academic Press, London. pp. 97-123.
- Hewitt, G.M. 1996. Some genetic consequences of ice ages, and their role in divergence and speciation. *Biological Journal of the Linnean Society* 58: 247-276.

- Hewitt, G.M. 1999. Post-glacial re-colonization of European biota. *Biological Journal of the Linnean Society* 68: 87–112.
- Hewitt, G.M. 2000. The genetic legacy of the Quaternary ice ages. *Nature* 405: 907-913.
- Hewitt G.M. 2001. Speciation, hybrid zones and phylogeography: or seeing genes in space and time. *Molecular Ecology* 10: 537–549.
- Hewitt, G.M. 2004a. Genetic consequences of climatic oscillations in the Quaternary. *Philosophical Transactions of the Royal Society of London. Series B, Biological Sciences* 359: 183-195.
- Hewitt, G.M. 2004b. The structure of biodiversity – insights from molecular phylogeography. *Frontiers in Zoology* 1: 18-33.
- Huang, S.S.F., Chiang, Y.C., Schaal, B.A., Chou, C.H. and Chiang, T.Y. 2001. Organelle DNA phylogeography of *Cycas taitungensis*, a relict species in Taiwan. *Molecular Ecology* 10: 2669-2682.
- Huang, S.S.F., Huang, S-Y. and Lin, T-P. 2002. Spatial pattern of chloroplast DNA variation of *Cyclobalanopsis glauca* in Taiwan and East Asia. *Molecular Ecology* 11: 2349-2358.
- Hubberten, H.W., Andreev, A., Astakhov, V.I., Demidov, I., Dowdeswell, J.A., Henriksen, M., Hjort, C., Houmark-Nielsen, M., Jakobsson, M., Kuzmina, S., Larsen, E., Lunkka, J.P., Lysa, A., Mangerud, J., Möller, P., Saarnisto, M., Schirmer, L., Scher, A.V., Siegert, C., Siegert, M.J. and Svedsen, J.I. 2004. The periglacial climate and environment in northern Eurasia during last glaciation. *Quaternary Science Review* 23: 1333-1357.
- Huelsenbeck, J.P. and Ronquist, F. 2001. Mr Bayes: A program for the Bayesian inference of phylogeny. *Bioinformatics* 17:754-755.
- Huenneke L.F. 1991. Ecological implications of genetic variations in plant populations. In: Falk, D.A. and Holsinger, K.E. (Eds) *Genetics and conservation of rare plants*. Oxford University Press, New York, pp. 31-44.
- Huntley, B. and Birks, H.J.B. 1983. *An Atlas of Past and Present Pollen Maps for Europe: 0-13,000 Years Ago*. Cambridge University Press, Cambridge.

- Husband, B.C. and Barrett S.C.H. 1996. A metapopulation perspective in plant population biology. *Journal of Ecology* 84: 461-469.
- Hylander, K. 1998. Hårklomossa, *Dichelyma capillaceum* - ekologi och aktuell förekomst i Sverige. *Svensk Botanisk Tidskrift* 92: 95
- Hyvönen, J., Hedderson, T.A., Smith Merrill, G.L., Gibbings, J.G. and Koskinen, S. 1999. On phylogeny of the Polytrichales. *Bryologist* 101: 489-504.
- Ignatov, M.S. and Afonina, O.M., 1992 - Checklist of the mosses of the former USSR. *Arctoa* 1: 1-85.
- Ignatov, M. and Ignatova, E. 2001. On the zoochory of *Schistostega pennata* (Schistostegaceae, Musci). *Arctoa* 10: 83-96.
- Imbrie, J., Berger, A. and Shackleton, N.J. 1993. Role of orbital forcing: a two-million-year perspective. – In: Eddy, J. A. and Oeschger, H. (Eds.), *Global Changes in the Perspective of the Past*. Wiley, Chichester, UK. Pp. 263–277.
- Imbrie, J., McIntyre, A. and Mix, A. 1989. Oceanic response to orbital forcing in the late Quaternary: observational and experimental strategies. - In: Berger, A., Schneider, A. and Duplessy, J.C. (Eds.), *Climate and Geo-Sciences*. Kluwer, Dordrecht, The Netherlands. Pp. 121-164.
- Ireland, R. R. 1989. Distribution of the moss genus *Dichelyma* in Canada. *Lindbergia* 15 (2): 65-69.
- Jackson, S.T. and Overpeck, J.T. 2000. Responses of plant populations and communities to environmental changes of the late Quaternary. *Paleobiology* 26: 194-220.
- James T.Y., Moncalvo S.L. and Vilgalis R. 2001. Polymorphism at the ribosomal DNA spacer and its relation to breeding structure of the widespread mushroom *Schizophyllum commune*. *Genetics* 157: 149-161.
- Jansen, E. and Sjöholm, J. 1991. Reconstruction of glaciation over the past 6 Myr from ice-borne deposits in the Norwegian Sea. *Nature* 349: 600-603.
- Janssens, J.A. 1983. Quaternary fossil bryophytes in North America: new records. *Lindbergia* 9: 137-151.

- Jansson, R. and Dynesius, M. 2002. The fate of clades in a world of recurrent climatic change: Milankovitch Oscillations and Evolution. *Annual Review of Ecology and Systematics* 33: 741-777.
- Jarret, R.L. and Newman, M. 2000. Phylogenetic relationships among species of *Citrullus* and the placement of *C. rehmii* De Winter as determined by Internal Transcribed Spacer (ITS) sequence heterogeneity. *Genetic Resources and Crop Evolution* 47: 215-222.
- Jobst, J., King, K. and Hemleben, V. 1998. Molecular Evolution of Internal Transcribed Spacers (ITS1 and ITS2) and phylogenetic relationships among species of the family Cucurbitaceae. *Molecular Phylogenetics and Evolution* 9(2): 204-219.
- Jovet-Ast, S. 1967. Bryophyta. – In: Boureau, E. (ed.) *Traité de Paléobotanique*, vol II. Maisson de Cie, Paris, pp. 17-186.
- Kanno, A. and Hirai, A. 1992. Comparative studies of structure of chloroplast DNA from four species of *Oryza*: cloning and physical maps. *Theoretical and Applied Genetics* 83: 791-798.
- Karp, A., Seberg, O. and Buiatti, M. 1996. Molecular techniques in the assessment of botanical diversity. *Annals of Botany* 78: 143-149.
- Kelch, D.G., Driskell, A. and Mishler, B.D. 2004. Inferring phylogeny using genomic characters: a case study using land plant plastomes. –In: Goffinet, B., Hollowell, V. and Magill, R. (Eds.) *Molecular systematics of bryophytes*. Missouri Botanical Garden Press, St. Louis. Pp. 3-12.
- Kelchner, S.A. 2000. The evolution of non-coding chloroplast DNA and its application in plant systematics. *Annals of the Missouri Botanical Garden* 87: 482-498.
- Kim S.-C., Lee C. and Santos Guerra A. 2005. Genetic analysis and conservation of the endangered Canary Island woody sow-thistle, *Sonchus gandogerii* (Asteraceae). *Journal of Plant Research* 118: 147-153.
- Kimmerer, R.W. 1991. Reproductive ecology of *Tetraphis pelucida*. II. Differential success of sexual and asexual propagules. *Bryologist* 94: 284-288.

- Kimmerer, R.W. 1994. Ecological consequences of sexual versus asexual reproduction in *Dicranum flagellare* and *Tertraphis pellucida*. *Bryologist* 97: 20-25.
- King, R. A. and Ferris, C. 1998. Chloroplast DNA phylogeography of *Alnus glutinosa* (L.) Gaertn. *Molecular Ecology* 7: 1151-1161.
- Kitching, I.J. 1992. Tree building techniques. –In: Forey, P. L., Humphries, C. J., Kitching, I. J., Scotland, R. W., Siebert, D. J. and Williams, D. M. (Eds.). *Cladistics: a practical course in systematics*. Oxford University Press. Pp.191.
- Kluge, A.G. and Farris, J.S. 1969. Quantitative phyletics and the evolution of anurans. *Systematic Zoology* 18:1-32.
- Knowels, L.L. 2001. Did the Pleistocene glaciations promote divergence? Tests of explicit refugial models in montane grasshoppers. *Molecular Ecology* 10: 691-701.
- Koch, M.A., Dobes, C. and Mitchell-Olds, T. 2003. Multiple hybrid formation in natural populations: Concerted evolution of the Internal Transcribed Spacer of nuclear ribosomal DNA (ITS) in North American *Arabis divaricarpa* (Brassicaceae). *Molecular Biology and Evolution* 20: 338-350.
- Koopman, W.J.M., Zevenbergen, M.J. and Van Den Berg, R.G. 2001. Species relationships in *Lactuca* s.l. (Lactuceae, Asteraceae) inferred from AFLP fingerprints. *American Journal of Botany* 88: 1881-1887.
- Kotiranta, H., Uotila, P., Sulkava, S. and Peltonen, S. L. 1998. Red Data Book of East Fennoscandia. Helsinki, Ministr. Environment. 351. pp
- Kuc, M. 1960. La distribution géographique de *Tortula velenovskyi* Schiffner. *Revue Bryologique- Lichénologique* 29: 92-96.
- Kučera, J. and Váňa, J. 2003. Check- and Red List of bryophytes of the Czech Republic (2003). *Preslia* 75: 193-222.
- Kukla, G.J. 2000. Paleoclimate: the last interglacial. *Science* 287: 987–988.
- Kürschner, H. and Wagner, D. 2005. Phytosociology and life strategies of a new loess slope bryophyte community from N China (Gansu), including *Crossidium laxefilamentosum* new to China. *Nova Hedwigia* 81 (1-2): 229-246.

- Lawton, E. 1971. *Mosses of the Pacific Northwest*. Nichinan.
- Lazarenko, A.S. 1974. Some Considerations on the Nature and Behavior of the Relict Moss, *Desmatodon randii*. *Bryologist* 77 (3): 474-477.
- Lessios, H.A., Kessing, B.D. and Pearse, J.S. 2001. Population structure and speciation in tropical seas: global phylogeography of the sea urchin *Diadema*. *Evolution* 55: 955-975.
- Lewis, P.O. 1988. Maximum likelihood as an alternative to parsimony for inferring phylogeny using nucleotide sequence data. –In: Soltis, D. E., Soltis, P.S. and Doyle, J. J. (Eds.). *Molecular Systematics of plants II*. DNA sequencing. Kluwer Academic Press; Boston, Dordrecht, London. Pp. 574.
- Lewis Smith, R.I. 1999. Biological and environmental characteristics of tree cosmopolitan mosses dominant in continental Antarctica. *Journal of Vegetation Science* 10: 231-242.
- Li, J., Alexander, J.H. and Donglin, Z. 2002. Paraphyletic *Syringa* (Oleaceae): Evidence from Sequences of Nuclear Ribosomal DNA ITS and ETS Regions. *Systematic Botany* 27 (3): 592-597.
- Linder, C.R., Goertzen, L.R., Heuvel, B.V., Francisco-Ortega, J. and Jansen, R.K. 2000. The complete external transcribed spacer of 18S-26S rDNA: amplification and phylogenetic utility at low taxonomic levels in Asteraceae and closely allied families. *Molecular Phylogenetics and Evolution* 14: 285–303.
- Limpricht, G. 1885-1903. *Die Laubmoose Deutschlands, Oesterreichs und der Schweiz 1-3*. Eduard Kummer: Leipzig.
- Limpricht, K.W. 1896. *Die Laubmoose*. - *Rabenhorst's Kryptogamenflora Vierter Band III. Abteilung*. Leipzig (Kummer).
- Liston, A., Robinson, W. A., Oliphant, J. M. and Alvarez-Buylla, E. R. 1996. Length variation in the nuclear ribosomal DNA internal transcribed spacer region of non-flowering seed plants. *Systematic Botany* 21: 109-120.
- Lloret, F. 1994. Gap colonization by mosses on a forest floor: an experimental approach. *Lindbergia* 19: 122-128.

- Loeske, L. 1903. *Moosflora des Harzes*. - Leipzig (Bornträger).
- Longton, R.E. and Miles, C.J. 1982. Studies on the reproductive biology of mosses. *Journal of the Hattori Botanical Laboratory* 52: 219-240.
- Longton, R.E. and Schuster, R.M. 1983. Reproductive biology. – In: Schuster, R.M. (Ed.) *New Manual of Bryology* 1. Nichian, HBL. Pp. 386-462.
- Marino, P.C. 1991. Dispersal and coexistence of mosses (*Splachnaceae*) in patchy habitats. *Journal of Ecology* 79: 1047-1060.
- Markos, S. and Baldwin, B.G. 2001. Higher-level relationships and major lineages of *Lessingia* (Compositae, Astereae) based on nuclear rDNA internal and external transcribed spacers (ITS and ETS) sequences. *Systematic Botany* 26:168–183.
- Markos, S. and Baldwin, B.G. 2002. Structure, molecular evolution and phylogenetic utility of the 5' region of the external transcribed spacer of 18S-26S rDNA in *Lessingia* (Compositae, Astereae). *Molecular Phylogenetics and Evolution* 23: 214-228.
- Marshall, H.D., Newton, C. and Ritland, K. 2002. Chloroplast phylogeography and evolution of highly polymorphic microsatellites in lodgepole pine (*Pinus contorta*). *Theoretical and Applied Genetics* 104: 367-378.
- Marshall, W.A. and Convey, P. 1997. Dispersal of the moss propagules on Signy Island, maritime Antarctic. *Polar Biology* 18: 376-383.
- Maslin, M.A., Li, X.S., Loutre, M.F. and Berger, A. 1998. The contribution of orbital forcing to the progressive intensification of northern hemisphere glaciation. *Quaternary Science Reviews* 17 (4-5): 411-426.
- Mayer, M.S. and Soltis, P.S. 1999. Intraspecific phylogeny analysis using ITS sequences: Insights from studies of the *Streptanthus glandulosus* complex (Cruciferae). *Systematic Botany* 24: 47 – 61.
- Mayr, E. 1963. *Animal species and evolution*. Harvard University Press, Cambridge, MA.
- McCauley, D.E., Stevens, J.E., Peroni, P.A. and Raveil, J.A. 1996. The spatial distribution of chloroplast DNA and allozyme polymorphisms within a

- population of *Silene alba* (Caryophyllaceae). *American Journal of Botany* 83: 727-731.
- McDaniel S. F. and Miller N. G., 2000 - Winter dispersal of bryophyte fragments in the Adirondack Mountains, New York. *Bryologist* 103: 592-600.
- McDaniel, S.F. and Shaw, A.J. 2003. Phylogeographic structure and cryptic speciation in the trans-antarctic moss *Pyrrhobryum mnioides*. *Evolution* 57: 205-215.
- McGlone, M.S. 1996. When history matters: scale time, climate and tree diversity. *Global Ecology and Biogeography* 5: 309-314.
- McIntosh, T.T. 1989 - Bryophyte records from the semi-arid steppe of north-western North America, including four species new to North America. *Bryologist* 92: 356-362.
- McKinney, M. L. 1997. Extinction, vulnerability and selectivity: combining ecological and paleontological views. *Annual Review of Ecology and Systematics* 28: 459-516.
- Meißner, K., Frahm, J.-P., Stech, M. and Frey, W. 1998. Molecular divergence patterns and infragenetic relationship of *Monoclea* (Monocleales, Hepaticae). Studies in austral temperate rain forest bryophytes 1. *Nova Hedwigia* 67: 289-302.
- Miles, C.J. and Longton, R.E. 1992. Deposition of the moss spores in relation to distance from parent gametophytes. *Journal of Bryology* 17: 335-368.
- Miller, N. G. 1980. Quaternary fossil bryophytes in North America: catalogue and annotated bibliography. *Journal of the Hattori Botanical Laboratory* 47: 1-34.
- Miller, N.G. and Ambrose, L.J.H. 1976. Growth in culture of wind blown bryophyte gametophyte fragments from arctic Canada. *Bryologist* 79: 55-63.
- Miller, N.G. and McDaniel, S. F. 2004. Bryophyte dispersal inferred from colonization of an introduced substratum on Whiteface Mountain, New York. *American Journal of Botany* 91 (8): 1173-1182.
- Mogensen G.S. 1981. The biological significance of morphological characters in bryophytes: the spore. *Bryologist* 84: 187-207.

- Mogesen G.S. and Zander R.H., 1999 - *Hilpertia velenovskyi* (Musci, Pottiaceae) new to the Arctic from Ellesmere Island, Northeastern Canada. *Bryologist* 102: 753-755.
- Mönkemeyer, W. 1927. *Die Laubmoose Europas. Rabenhorsts Kryptogamen-Flora von Deutschland. Österreich und der Schweiz Bd. IV, Er. Bd.* Leipzig (Akademische Verlagsgesellschaft), 960 pp.
- Morrell, P.L. and Rieseberg, L.H. 1998. Molecular tests of the proposed diploid hybrid origin of *Gilia achilleifolia* (Polemoniaceae). *American Journal of Botany* 85: 1439-1453.
- Müller, F. 2000. Das Laubmoos *Hilpertia velenovskyi* (Schiffn.) Zander (Pottiaceae, eine für die Flora Deutschlands neue Art. *Limprichtia* 14: 49-58.
- Müller, U. C., Pross, J. and Bibus, E. 2003. Vegetation response to rapid climate change in Central Europe during past 140000 yr based on evidence from the Füramoos pollen record. *Quaternary Research* 59: 235-245.
- Müller, J., and Müller, K. 2004. Treegraph: automated drawing of complex tree figures using an extensible tree description format. *Molecular Ecology Notes* 4: 786-788.
- Muñoz, J., Felicísimo, A. M., Cabezas, F., Burgaz, A. R. and Martínez, I. 2004. Wind as a long-distance dispersal vehicle in the Southern Hemisphere. *Science* 304: 1144-1147.
- Nathan R. 2001. Dispersal biogeography, in: Levin, S.A. (Ed.), *Encyclopedia of biodiversity II*. Academic Press, New York, USA.
- Natcheva, R. and Cronberg, N. 2003. Genetic diversity in populations of *Sphagnum capillifolium* from the mountains of Bulgaria, and their possible refugial role. *Journal of Bryology* 25 (2): 91-99.
- Nebel M. and Philippi G. (Eds.), 2001. *Die Moose Baden Württembergs*. Band 2. Stuttgart (Ulmer).
- Nei, M. 1996. Phylogenetic analyses in molecular evolutionary genetics. *Annual Review in genetics* 30: 371-403.

- Nixon, K.C. 1999. The parsimony ratchet, a new method for rapid parsimony analysis. *Cladistics* 15: 407-414.
- Nyholm, E. 1954-1968. *Illustrated Moss Flora of Fennoscandia*. Lund (Gleerup), 799 pp.
- Obgaard, B.V. 1988. Glacial relicts and the moss *Meesia triquetra* in Central and Western Europe. *Lindbergia* 14: 73-78.
- Ochyra, R. 1992. *Czerwona lista mchów zagrożonych Polsce (Red list of threatened mosses in Poland)*. Polish Academy of Sciences, pp. 79-85.
- Odrzykoski, I.J. and Szweykowski, J. 1991. genetic differentiation without concordant morphological divergence in the thallose liverwort *Conocephalum conicum*. *Plant Systematics and Evolution* 178: 135-151.
- Olsen, P.E. 1986. A 40-million-year lake record of early Mesozoic orbital climatic forcing. *Science* 234: 842-848.
- Olsen, K.M. and Schaal, B.A. 1999. Evidence on the origin of cassava: phylogeography of *Manihot esculenta*. *Proceedings of the National Academy of Sciences, USA* 96: 5586-5591.
- Otto, S.P. and Witton, J. 2000. Polyploid incidence and evolution. *Annual Review of Genetics* 34: 401-437.
- Palmer, J.D. 1987. Chloroplast DNA evolution and biosystematic uses of chloroplast DNA variation. *American Naturalist* 130: 6-29.
- Palumbi, S.R., Cipriano, F. and Hare, M. 2001. Predicting nuclear gene coalescence from mitochondrial data: the three-times rule. *Evolution* 55(5): 859-868.
- Patti, F.P. 2002. *WinModeltest front-end v4b*. Program distributed by the author, Harvard.
- Petit, R.J., Kremer, A. and Wagner, D.B. 1993. Finite island model of organelle and nuclear genes in plants. *Heredity* 71: 630-641.
- Pfeiffer, T. 2000a. Molecular relationship of *Hypopterygium 'rotundum'* s.l. (Hypopterygiaceae, Bryopsida) inferred from *trnL* intron sequences. Studies in austral temperate rain forest bryophyte 7. *Edinburgh Journal of Botany* 57: 291-307.

- Pfeiffer, T. 2000b. Relationship and divergence patterns of *Hymenophyton* species (Metzgeriidae, Hepatophytina) in New Zealand and Tasmania. *Studies in austral temperate rain forest bryophyte* 5. *New Zealand Journal of Botany* 38: 415-423.
- Pfeiffer, T., Fritz, S., Stech, M. and Frey, W. 2006. Vegetative reproduction and clonal diversity in *Rhytidium rugosum* (Rhytidiaceae, Bryopsida) inferred by morpho-anatomical and molecular analyses. *Journal of Plant Research* 119(2): 125-135.
- Pilous, Z. 1958 - Fragmenta bryologica. *Preslia* 30: 31-40.
- Pinceel, J., Jordaens, K., Pfenninger, M. and Backeljau, T. 2005. Range phylogeography of a terrestrial slug in Europe: evidence for Alpine refugia and rapid colonization after the Pleistocene glaciations. *Molecular Ecology* 14: 1133-1150.
- Pócs, T. 1999. A löszfalak virágtalan növényzete I. Orografikus sivatag a Kárpát-medencében. (Studies on the cryptogamic vegetation of loess cliffs, I. Orographic desert in the Carpathian Basin). *Kitaibelia* 4(1): 143–156.
- Pócs, T., Goia, I., Kis, G., Orbán, S., Sass-Gyarmati, A. and Van Zanten, B.O. 2002 - *Hilpertia velenovskyi* (Schiffn.) Zander and other pottoid mosses (Bryophyta) new to Romania. Studies on the cryptogamic vegetation of loess cliffs, IX. *Contributii Botanicae Grad. Bot. A. Borza Cluj-Napoca* 37: 13–24.
- Pócs, T., Sabovljević, M., Puche, F., Segarra-Moragues, J.G., Gimeno, C. and Křrschner, H. 2004. *Crossidium laxefilamentosum* Frey and Křrschner (Pottiaceae), new to Europe and to North Africa. (Studies on the cryptogamic vegetation on loess cliffs, VII.) *Journal of Bryology* 26: 113–124.
- Podpera, J. 1954. *Conspectus Muscorum Europaeorum*. Prag.
- Posada, D. and Crandall, K.A. 1998. Modeltest: testing the model of DNA substitution. *Bioinformatics* 14: 817-818.
- Posada, D. and Buckley, T.R. 2004. Model selection and model averaging in phylogenetics: advantages of the AIC and Bayesian approaches over likelihood ratio tests. *Systematic Biology* 53: 793-808

- Preston, C. D. 1984. A check-list of Greek mosses. *Journal of Bryology* 13: 43-95.
- Quandt, D., Frahm, J.-P. and Hébrard, J.-P. 2000. Isoenzymanalysen zur Klärung der Frage von Xerothermenrelikten unter den Moosen in Mitteleuropa. 1. Der Status von *Bartramia stricta* Brid. Im Moselgebiet (Deutschland). *Cryptogamie Bryologie* 21: 77-86.
- Quandt, D., Frahm, J.-P. and Frey, W. 2001. Patterns of molecular divergence within paleoaustral genus *Weymouthia* Broth. (Lembophyllaceae, Bryopsida). *Journal of Bryology* 23: 305-311.
- Quandt, D., Müller, K., Stech, M., Hilu, K.W., Frey, W., Frahm, J.-P. and Borsch, T. 2004a. Molecular evolution of the chloroplast *trnL-F* region in land plants. *Monographs in Systematics of the Missouri Botanical Garden* 98: 13-37.
- Quandt, D., Huttunen, S., Streimann, H., Frahm, J.-P. and Frey, W., 2004b. Molecular phylogenetics in the Meteoriaceae s.str.: focusing on the genera *Meteorium* and *Papillaria*. *Molecular Phylogenetics and Evolution* 32: 435-461.
- Rájczy, M. 1990. Mohák-Bryophyta. - In: Rakonczai Z. (Ed.), *Vörös könyv*. Akadémiai Kiadó, Budapest, pp. 322-325.
- Ramsey, J. and Schemske, D.W. 1998. Pathways, mechanisms, and rates of polyploid formation in flowering plants. *Annual Review of Ecological Systematics* 29: 467 – 501.
- Rauscher, J.T., Doyle, J.J. and Brown, A.H.D. 2002. Internal transcribed spacer repeat-specific primers and the analysis of hybridisation in the *Glycine tomentella* (Leguminosae) polyploidy complex. *Molecular Ecology* 11: 2691-2702.
- Raymo, M.E. 1994. The initiation of Northern Hemisphere glaciation. *Annual review of earth and planetary sciences* 22: 353-383.
- Remington, C.L. 1968. Suture-zones of hybrid interaction between recently joined biotas. *Evolutionary Biology* 2: 321-428.
- Roy, K., Valentine, J. W., Jablonski, D. and Kidwell, S. M. 1996. Scales of climatic variability and time averaging in Pleistocene biotas: implications for ecology and evolution. *Trends in Ecology and Evolution* 11: 458-463.

- Sabovljević, M., Cvetić, T. and Stevanović, V. 2004. Bryophyte Red List of Serbia and Montenegro. *Biodiversity and Conservation* 13: 1781-1790.
- Sabovljević, M., Frahm, J.-P. and Herbiniaux, U. in press. Taxonomic value, systematic position and the origin of German populations of *Isothecium holtii* Kindb. based on molecular data. *Lindbergia*
- Saitou, N. and Nei, M. 1987. The neighbour-joining method: a new method for reconstructing phylogenetic trees. *Molecular Biology and Evolution* 4(4): 406-425.
- Salinas, J., Matassi, G., Montero, L.G. and Bernardi G. 1988. Compositional compartmentalization and compositional patterns in the nuclear genomes of plants. *Nucleic Acidic Research* 16: 4269-4285.
- Sang, T., Crawford, D.J. and Stuessy, T.F. 1995. Documentation of reticulate evolution in peonies (*Paeonia*) using Internal Transcribed Spacer sequences of nuclear ribosomal DNA: Implications for biogeography and concerted evolution. *Proceedings of the National Academy of Sciences, USA* 92: 6813-6817.
- Sarafis, V. 1971. A biological account of *Polytrichum commune*. *New Zealand Journal of Botany* 9: 711-724.
- Sastrad, S.M., Flatberg, K.I. and Hanssen, L. 2000. Origin, taxonomy and population structure of the allopolyploid peat moss *Sphagnum majus*. *Plant Systematics and Evolution* 225: 73-84.
- Shaal B.A., Leverich W. J. and Rogstad S. H., 1991 – A comparison of methods for assessing genetic variation in plant conservation biology. - In: FALK D.A. & HOLSINGER, K. E. (Eds) *Genetics and conservation of rare plants*. Oxford University Press, New York, pp. 123-134.
- Schaal, B.A. and Olsen, K.M. 2000. Gene genealogies and population variation in plants. *Proceedings of the National Academy of Sciences, USA* 97: 7024-7029.

- Schaal, B.A., Hayworth, D.A., Olsen, K.M., Rauscher, J.T. and Smith, W.A. 1998. Phylogeographic studies in plants: problems and prospects. *Molecular Ecology* 7: 465-474.
- Schluter, D. 2000. *The ecology of adaptive radiations*. Oxford University Press, Oxford.
- Schneller, J. J. and Holderegger, R. 1966. Colonization events and genetic variability within populations of *Asplenium ruta-muraria*. In: Camus, J. M., Gibby, M. and Johns, R.J. (eds.) *Pteridology in perspective*. Royal Botanical Gardens, London. Pp. 571-580.
- Schofield, W.B. 1985. *Introduction to bryology*. MPC, New York and CMP, London. Pp. 431
- Schönwiese, C. 1995. *Klimaänderungen*. Berlin (Springer) 224 pp.
- Schuster, R.M. 1984. Phytogeography of the bryophyta. – In: Schuster, R. (Ed.), *New Manual of Bryology*. Hattori Botanical Laboratory, Japan. Pp. 463-626.
- Schwarzbach, M. 1993. *Das Klima der Vorzeit*. - Stuttgart (Enke), 380 pp.
- Sérgio C., Casas C., Brugués M. and Cros R.M. 1994. *Lista Vermelha dos Briófitos da Península Ibérica* [Red List of Bryophytes of the Iberian Peninsula] Lisboa: ICN.
- Sernander, R. 1901. *Den Skandinaviska vegetationens sprindings biologi*. Berlin, Uppsala: Friedländer and Sohn, Lundequistka Bokhandeln.
- Shaw, A.J. 1995. Genetic biogeography of the rare copper moss *Scopelophila cataractae* (Pottiaceae). *Plant Systematics and Evolution* 197: 43-58.
- Shaw, A.J. 2000. Molecular phylogeography and cryptic speciation in the mosses *Mielichhoferia elongata* and *M. mielichhoferiana* (Bryaceae). *Molecular Ecology* 9: 595-608.
- Shaw, A.J. 2001. Biogeographic patterns and cryptic speciation in bryophytes. *Journal of Biogeography* 28: 253-261.
- Shaw, A.J. and Allen, B.H. 2000. Phylogenetic relationships, morphological incongruence and geographic speciation in the Fontinalaceae (Bryophyta). *Molecular Systematics and Evolution* 16: 225-237.

- Show, A. J. and Allen, B. 2002. Phylogenetic relationship, morphological incongruence and geographic speciation in the Fontinalaceae (Bryophyta). *Molecular Phylogenetics and Evolution* 16(2): 225-237.
- Shaw, A.J. and Schneider, R.E. 1995. Genetic biogeography of the rare copper moss, *Mielichhoferia elongata* (Bryaceae). *American Journal of Botany* 82: 8-17.
- Shaw, A.J., McDaniel, S.F., Werner, O. and Ros, R.M. 2002. New frontiers in bryology and lichenology: phylogeography and phylodemography. *Bryologist* 105: 373-383.
- Shaw, A.J., Werner, O. and Ros, R.M. 2003a. Intercontinental Mediterranean disjunct mosses: morphological and molecular patterns. *American Journal of Botany* 90: 540-550.
- Shaw, A.J., Werner, O. and Ros, R.M. 2003b. Transcontinental Mediterranean disjunct mosses: morphological and molecular patterns. *American Journal of Botany* 90: 480-490.
- Simon, D., Fewer, D., Friedl, T. and Bhattacharya, D. 2003. Phylogeny and self splicing ability of the plastid tRNA-Leu group I intron. *Journal of Molecular Evolution* 57: 710-720.
- Sinclair, W. T., Mormon, J. D. and Enos, R. A. 1999. The postglacial history of Scots pine (*Pinus sylvestris* L.) in western Europe: evidence from mitochondrial DNA variation. *Molecular Ecology* 8: 83-88.
- Skellam, J.G. 1951. Random dispersal in theoretical populations. *Biometrika* 38: 196-218.
- Skotnicki, M. L., Ninham, J.A. and Selkirk, P.M. 1998. High levels of RAPD diversity in moss *Bryum argenteum* in Australia, New Zealand and Antarctica. *Bryologist* 101: 412-421.
- Skotnicki, M.L., Ninham, J.A. and Selkirk, P.M. 2000. Genetic diversity, mutagenesis and dispersal of antarctic mosses – a review of progress with molecular studies. *Antarctic Science* 12: 636-373.

- Skotnicki M.L., Selkirk P.M., Broady P., Adam K.D. and Ninham J. A. 2001. Dispersal of the moss *Campylopus pyriformis* on geothermal ground near summits of Mount Erebus and Mount Melbourne, Victoria Land, Antarctica. *Antarctic Science* 13: 280-285.
- Skotnicki, M.L., Mackenzie, A.M., Ninham, J.A. and Selkirk, P.M. 2004. High level of genetic variability in the moss *Ceratodon purpureus* from continental Antarctica, subantarctic Heard and Macquarie Island and Australia. *Polar Biology* 27: 687-698.
- Skotnicki, M.L., Mackenzie, A. and Selkirk, P.A. 2004. Mosses surviving on the edge: origins, genetic diversity and mutation in Antarctica. – In: Goffinet, B., Hollowell, V. and Magill, R. (Eds.), *Molecular Systematics of Bryophytes*. Missouri Botanical Garden Press. St. Louis. Pp. 389-403.
- Smith, A.J.E. 1978: *The Moss Flora of Britain and Ireland*. - Cambridge (Cambridge University Press), 706 pp.
- Smith, R.I.L. 1984. Terrestrial plant biology of the subantarctic and Antarctic. – In: Laws, R. J. (Ed.), *Antarctic Ecology*. Academic Press, London. Pp. 61-162.
- Smith, R.I.L. 1993. Dry coastal ecosystems of Antarctica. – In: van der Maarel, E. (Ed.), *Ecosystems of the world 2A*. Elsevier, Amsterdam. Pp. 51-71.
- Smouse, P.E. 1998. To tree or not to tree. *Molecular Ecology* 7: 399-412.
- Soltis, P.S. and Soltis, D.E. 1999. Polyploidy: recurrent formation and genome evolution. *Trends in Ecology and Evolution* 14: 348-352.
- Soltis, P.S. and Soltis, D.E. 2000. The role of genetic and genomic attributes. in the success of polyploids. *PNAS* 97: 7051-7057.
- Soltis, D.E., Soltis, P.S. and Milligan, B.G. 1992. Intraspecific chloroplast DNA variation: systematic and phylogenetic implications. - In: Soltis, P.S., Soltis, D.E. and Joyle, J.J. (Eds) *Molecular Systematics of Plants*. New York, Chapman and Hall. Pp 117-150.
- Stech, M. 1999. *Molekulare Systematik haplolepider Laubmoose (Dicranaceae, Bryopsida)*. Dissertation Freie Universität Berlin, 114 pp.

- Stech, M. and Frahm, J.-P. 2001 - The systematic position of *Ochyraea tatrensis* (Hypnobartelliaceae, Bryopsida) based on molecular data. *Bryologist* 104: 199-203.
- Stech, M. and Frey, W. 2001. cpDNA relationship and classification of liverworts (Hepaticophytina, Bryophyta). *Nova Hdwigia* 72: 45-58.
- Steere, W.C. 1937. *Bryoxiphium norvegicum*, the sword moss, as a preglacial and interglacial relict. *Ecology* 18 (3): 346-358
- Stenoien, H. and Sastad, S.M. 1999. Genetic structure in three haploid peat mosses (*Sphagnum*). *Heredity* 82: 391-400.
- Stewart, J.R. and Lister, A.M. 2001. Cryptic northern refugia and the origins of the modern biota. *Trends in Ecology and Evolution* 16: 608-613.
- Stonebruner, A., Lane, D.M. and Anderson, L.E. 1992. Spore liberation distances in the moss *Atrichum angustatum* (Polytrichaceae). *Bryologist* 95: 324-328.
- Stonebruner, A., Wyatt, R. and Odrzkoski, I.J. 1991. Applications of enzyme electrophoresis to bryophyte systematics and population biology. *Advances in Bryology* 4: 1-27.
- Sugiura, C., Kobayashi, Y., Setsuyuki, A., Sugita, C. and Mamoru, S. 2003. Complete chloroplast DNA sequence of the moss *Physcomitrella patens*: evidence for the loss and relocation of rpoA from the chloroplast to the nucleus. *Nucleic Acid Research* 31 (18): 5324-5331.
- Sullivan, J. and Joyce, P. 2005. Model Selection in Phylogenetics. *Annual Review in Ecology, Evolution and Systematics* 36: 445-466.
- Suter, M., Schneller, J.J. and Vogel, J. C. 2000. Investigation into genetic variation, population structure and breeding systems of the fern *Asplenium trichomanes* ssp. *ouadrivalens*. *International Journal of Plant Sciences* 161: 233-244.
- Swofford D.L. 2001. *PAUP**. *Phylogenetic analysis using parsimony (*and other methods)*. Version 4. Sinauer Associates, Sunderland, MA.
- Swofford, D.L. 2002. *PAUP**: *Phylogenetic analysis using parsimony (*and other methods)*, version 4.0B10. Sinauer, Sunderland, MA.

- Swofford, D.L., Olsen, G.J., Waddell, P.J. and Hillis, D.M. 1996. Phylogenetic Inference. – In: Hillis, D. M., Moritz, C. and Mable, B. K. (Eds.). *Molecular Systematics*. Sinauer Associates Inc. USA. Pp. 407-514.
- Taberlet, P., Gielly, L., Pautou, G. and Bouvet, J. 1991. Universal primers for amplification of three non-coding regions of chloroplast DNA. *Plant Molecular Biology* 17: 1105-1109.
- Taberlet, P., Fumagalli, L., Wust-Saucy, A.G. Cosson, J.F. 1998. Comparative phylogeography and postglacial colonization routes in Europe. *Molecular Ecology* 7: 453-464.
- Tan, B.C. and Zhao, J.C. 1997. New moss records and range extensions of some xeric and alpine moss species in China. *Cryptogamie- Bryologie Lichénologie* 18: 207-212.
- Templeton, A.R., Routman, R.E. and Phillips, C.A. 1995. Separating population structure from population history: a cladistic analysis of the geographical distribution of mitochondrial DNA haplotypes in the tiger salamander, *Ambystoma tigrinum*. *Genetics* 140: 767-782.
- Templeton, A.R. 2001. Using phylogeographic analyses of gene trees to test species status and processes. *Molecular Ecology* 10: 779-791.
- Thinggaard, K. 2001. Population structure and genetic diversity of the amphiatlantic haploid peatmoss *Sphagnum affine* (Sphagnopsida). *Heredity* 87: 485-496.
- Thomas, C.D., Bodsworth, E.J., Wilson, R.J., Simmons, A.D., Davies, Z.G, Musche, L. and Conradt, L. 2001. Ecological and evolutionary processes at expanding range margins. *Nature* 411: 577-581.
- Toivonen, H. 1972. Distribution of *Dichelyma capillaceum* (With.) Myr. Emend. Br. et Scimp. (Bryophyta), especially in northwestern Europe. *Annales Botanici Fennici* 9: 102-106
- Torres, R.A., Ganal, M. and Hemleben, V. 1990. GC balance in the internal transcribed ITS1 and ITS2 of nuclear ribosomal RNA genes. *Journal of Molecular Evolution* 30(2): 171-181.

- Torrioni, A., Bandelt, H.-J., Macaulay, V., Richards, M., Cruciani, F., Rengo, C., Martinez-Cabrera, V., Villems, R., Kivisild, T., Metspalu, E., Parik, J., Tolk, H.-V., Tambets, K., Forster, P., Karger, B., Francalacci, P., Rudan, P., Janičijević, B., Rikards, O., Savontaus, M.-L., Huoponen, K., Laitinen, V., Koivumäki, S., Sykes, B., Hickey, E., Novelletto, A., Moral, P., Sellitto, D., Coppa, A., Al-Zaheri, N., Santachiara-Benerecetti, A. S., Semino, O. and Scozzari, R. 2001. A signal, from human mtDNA, of postglacial recolonization in Europe. *American Journal of Human Genetics* 69: 844-852.
- Touw, A. 1989. Fontinalaceae. – In: Touw, A. and Rubers, W. V. (eds.) *De Nederlandse bladmossen. Flora en verspreidingsatlas van de Nederlandse Musci (Sphagnum uitgezonderd)*. Stichting Uitgeverij Koninklijke Nederlands Natuurhistorische Vereniging, Utrecht. Pp. 345-347.
- Trewick, S.A., Morgan-Richards, M., Russell, S.J., Henderson, S., Rumsey, F.J., Pinter, I., Barrett, J.A., Gibby, M. and Vogel, J.C. 2002. Polyploidy, phylogeography and pleistocene refugia of the rockfern *Asplenium ceterach*: evidence from chloroplast DNA. *Molecular Ecology* 11: 2003-2012.
- Tung, C.-K. 1963. Notes on some xerophytic mosses in China. *Acta Scientiarum Naturalium Universitatis Intramongoliae* 6: 173-184.
- Uit de Weerd, D.R., Schneider D. and Gittenberger E. 2005. The provenance of the Greek land snail species *Isabellaria pharsalica*: molecular evidence of recent passive long-distance dispersal. *Journal of Biogeography* 32: 1571-1581.
- Uyar, G. and Ören, M. 2005. *Isothecium holtii* Kindb. (Brachytheciaceae, Bryopsida) new to the moss flora of Turkey. *Cryptogamie, Bryologie* 26: 425-429.
- Van der Velde, M. and Bijlsma, R. 2003. Phylogeography of five *Polytrichum* species within Europe. *Biological Journal of the Linnean Society* 78: 203-213.
- Van Zanten B.O. 1978. Experimental studies on trans-oceanic long-range dispersal of moss spores in the Southern Hemisphere. *Journal of the Hattori Botanical Laboratory* 44: 455-482.
- Van Zanten, B.O. and Pócs, T. 1981. Distribution and dispersal of bryophytes. *Advances in Bryology* 1: 479-562.

- Vogel, J. C., Russell, S. J., Barrett, J.A. and Gibby, M. 1996. A non-coding region of chloroplast DNA as a tool to investigate reticulate evolution in European *Asplenium*. In: Camus, J. M., Gibby, M. and Johns, R.J. (eds.) *Pteridology in perspective*. Royal Botanical Gardens, London. Pp. 313-327.
- Vogel, J. C., Russell, S.J., Rumsey, F. J., Barrett, J.A. and Gibby, M. 1998. Evidence from maternal transmission of chloroplast DNA in the genus *Asplenium* (Aspleniaceae, Pteridophyta). *Botanica Acta* 111: 247-249.
- Vogel, J. C., Rumsey, F.J. and Schneller, S. J. 1999. Genetic structure, reproductive biology and ecology in isolated populations of *Asplenium ciskii* (Aspleniaceae, Pteridophyta). *Heredity* 83: 604-612.
- Volkov, R., Kostishin, S., Ehrendorfer, F. and Schweizer, D. 1996. Molecular organization and evolution of the external transcribed rDNA spacer region in two diploid relatives of *Nicotiana tabacum* (Solanaceae). *Plant Systematics and Evolution* 201: 117-129.
- Vos, P., Hogers, R., Bleeker, M., Reijans, M., van de Lee, T., Hornes, M., Frijters, A., Pot, J., Peleman, J., Kuiper, M., and Zabeau, M. 1995. *Nucleic Acid Research* 23: 4407-4414
- Waclawska Z., 1958 - *Tortula velenovskyi* Schiffner w Polsce. *Fragmenta Floristica et Geobotanica* III pars 2.
- Walton, D.W.H. 1990. Colonization of terrestrial habitats – organisms, opportunities and occurrence. – In: Kerry, K. R. and Hempel, G. (Eds.), *Antarctic ecosystems, ecological change and conservation*. Springer-Verlag, Berlin. Pp. 51-60.
- Webb, T. and Bartlein, P.J. 1992. Global changes during the last 3 million years: climatic controls and biotic responses. *Annual Review of Ecology and Systematics* 23: 141–173.
- Weider, L.J., Elser, J.J., Crease, T.J., Mateos, M., Cotner, J.B. and Markow, T.A. 2005. The functional significance of ribosomal (r)DNA variation: impacts on the evolutionary ecology of organisms. *Annual Review in Ecology, Evolution and Systematics* 36: 219-242.

- Weising, K. and Gardner, R.C. 1999. A set of conserved PCR primers for the analysis of simple sequence repeat polymorphisms in chloroplast genomes of dicotyledenous angiosperms. *Genome* 42: 9-19.
- Weising, K., Atkinson, R.G. and Gardner, R.C. 1995. Genomic finger-printing by microsatellite-primed PCR: a critical evaluation. *PCR Methods and Applications* 4: 249 – 255.
- Wendel, J.F. 2000. Genome evolution in plants. *Plant Molecular Biology* 42: 225 – 249.
- Wendel, J.F., Schnabel, A. and Seelanan, T. 1995. Bidirectional interlocus concerted evolution following allopolyploid speciations in cotton. *Proceedings of the National Academy of Sciences, USA* 92: 280-284.
- Werner, J. 1993. Check-list of the Bryophytes of Luxembourg. *Journal of Bryology* 17: 489-500.
- Werner, O. and Guerra, J. 2004. Molecular phylogeography of the moss *Tortula muralis* Hedw. (Pottiaceae) based on the chloroplast *rps4* gene sequence data. *Plant Biology* 6: 147-157.
- Werner, O., Ros, R. M., Guerra, J. and Shaw, A. J. 2003. Molecular data confirm the presence of *Anacolia menziesii* (Bartramiaceae, Musci) in southern Europe and its separation from *Anacolia webbii*. *Systematic Botany* 28: 483-489.
- White, T.J., Bruns, T., Lee, S. and Taylor, J. 1990. Amplification and direct sequencing of fungal ribosomal RNA genes for phylogenetics. - In: Innis, M. A., Gelfand, D. H., Sninsky, J.J. and White, T.J. (Eds.), *PCR Protocols: a guide to methods and applications*. Academic Press, San Diego, California, USA. Pp 315-322
- Williams, G.C. 1992. *Natural Selection: Domains, Levels, and Challenges*. Oxford University Press, New York
- Wright, H.E.Jr., Kutzbach, J.E., Webb, T.I.I.I., Ruddiman, W.F., Street-Perrott, F.A. and Bartlein, P.J. 1993. *Global Climates Since the Last Glacial Maximum*. University of Minneapolis Press, Minneapolis

- Wyatt R., Odrzykoski I.J. & Koponen T. 1997. *Mnium orientale* sp. nov. from Japan is morphologically and genetically distinct from *M. hornum* in Europe and North America. *Bryologist* 100: 226-236.
- Wyatt, R., Stoneburner, A. and Odrzykoski, I.J. 1989. Bryophyte isozymes: systematics and evolutionary implications. – In: Soltis, D. E. and Soltis, P. S. (Eds.) *Isozymes in plant biology*. Portland, Dioscorides Press. Pp. 221-240.
- Young, S.B. and Kläy, J-R. 1971. Bryophytes in the 1969 crater of deception island, Antarctica: an appaernt case of rapid long-distance dispersal. *Ohio Journal of Science* 71 (6): 358-362.
- Zachos, J.C., Flower, B.P. and Paul, H. 1997. Orbitally paced climate oscillations across the Oligocene/Miocene boundary. *Nature* 388: 567–570.
- Zachos, J., Pagani, M., Sloan, L., Thomas, E. and Billups, K. 2001. Trends, rhythms, and aberrations in global climate 65 Ma to present. *Science* 292: 686–693.
- Zander, R.H. 1989. Seven new genera in Pottiaceae (Musci) and a lectotype for *Syntrichia*. *Phytologia* 65: 424-436.
- Zander R.H. and Steere W.C. 1978. *Tortula scotteri* sp. nov. from the Northwest Territories of Canada. *Bryologist* 81: 463-467
- Zimmer, E.A., Martin, S.L., Beverley, S.M., Kan, Y.W. and Wilson, A.C. 1980. Rapid duplication and loss of genes coding for the α chains of hemoglobin. *Proceedings of the National Academy of Sciences, USA* 77: 2158-2162.
- Zurawski, G., Clegg, M.T. and Brown, A.H.D. 1984. The nature of nucleotide sequence divergence between barley and maize chloroplast DNA. *Genetics* 106: 735-749.

Lebenslauf

Geboren am 05.04.1974 in Belgrad, Serbien

Ausbildung:

1981-1993 Grundschule und Gymnasium in Belgrad, Abitur

1993-1994 Wehrdienst

1994-2000 Studium der Biologie, Universität Belgrad

2000 Diplom in Biologie (eins)

2001-2003 Postdiplom Studium in Pflanzenökologie, Universität Belgrad

2003 Master in Biologie (eins)

2004-2006 Doktorand am Nees Institut für Biodiversität der Pflanzen, Universität Bonn

Beruf:

1996-2002 Wissenschaftliche Mitarbeiter des Petnica Wissenschaftlichen Zentrum

2000- Wissenschaftliche und Unterrichtliche Mitarbeiter der Hochstuhl für Ökologie und Geographie der Pflanzen, Botanische Institut und Botanischer Garten, Biologische Fakultät der Universität Belgrad

Weitere Besonderheiten:

Publications:

Studies:

1. **Sabovljević, M.** and Marić, J. 1993. Contribution to the Knowledge of Forests' Communities of Petnica Surrounding. *Collection of Studies of Biological Research Society "Josif Pančić"*, Belgrade, 53-60. (in Serbio-Croat)
2. **Sabovljević, M.** 1995. Contribution to the Knowledge of the Flora of Petnica Surrounding. *Collection of Studies of 10th review of students research-scientific studies*, Belgrade, 51-72. (in Serbo-Croat)
3. Pavić, S., **Sabovljević, M.** and Stevanović, V. 1998. Diversity and threatened status of Yugoslav bryoflora, *Lindbergia* 23 (1): 38-44.
4. **Sabovljević, M.** and Stevanović, V. 1998. Pregled Flore Bryopsida Srbije sa sinonimima - Overview of Bryopsida Flora of Serbia with synonyms. *Nature Protection* 50: 147-168
5. **Sabovljević, M.** 1998. The Rare Bryophytes of Šara Mountain, Yugoslavia. *Planta Europa* 2: 159 - 161.
6. **Sabovljević, M.** and Stevanović, V. 1999. Moss Conspectus of Federal Republic of Yugoslavia. *Flora Mediterranea* 9: 65 - 95.
7. **Sabovljević, M.**, Stevanović, V. and Lakušić, D. 1999. *Buxbaumia viridis* (Moug. ex Lam. & DC.) Brid. ex Moug. & Nestl., rediscovered in Yugoslavia. *Phytologia Balcanica* 5 (1): 51 -52.
8. **Sabovljević, M.** 1999. *Anastrophyllum minutum* (Schreb.) Schuster, new to Serbia (FR Yugoslavia) and its distribution in the Balkans. *Phytologia Balcanica* 5 (2-3): 93 - 96.
9. **Sabovljević, M.** 2000. Checklist of hepatics of the Federal Republic of Yugoslavia. *Lindbergia* 25: 37 - 42
10. **Sabovljević, M.** and Stevanović, V. 2000. *Buxbaumia aphylla* Hedw. new to Montenegro (FR Yugoslavia), and some notes on its ecology. *Cryptogamie - Bryologie* 21(1): 87-89.
11. **Sabovljević, M.** and Stevanović, V. 2000. *Sphagnum denticulatum*, una novedad para la flora briofítica de Serbia (Yugoslavia). *Botanica Complutensis* 24: 61 - 63.
12. Blockeel, T. L., Bergamini, A., Bursa, G., Ertz, D., Sergio, C., Garcia, C., Hedenas, L., Müller, F. and **Sabovljević, M.** 2000. New national and regional bryophyte record, 3. *Journal of Bryology*, 22(4): 303-306.
13. **Sabovljević, M.**, Ganeva, A., Tsakiri, E. and Stefanut, S. 2001. Bryology and bryophyte protection in the south-eastern Europe. *Biological Conservation* 101: 73-84.
14. Papp, B. and **Sabovljević, M.** 2001. Contribution to the knowledge of the bryoflora of the region of Petnica (W. Serbia, Yugoslavia). *Studia Botanica Hungarica* 32: 107-120.

15. **Sabovljević, M.**, Bijelović, A. and Grubišić, D. 2001. Bryophytes as a potential source of medicinal compounds. *Lekovite Sirovine* 21: 17–29.
16. **Sabovljević, M.** 2001. Book review. C. Cortini – Pedrotti. Flora dei muschi d'Italia: Sphagnopsida, Andreaeopsida, Bryopsida (I parte). *Ekologija* 36(1): 101.
17. **Sabovljević, M.** and Cvetic, T. 2001. *Rhodobryum ontariense* (Kindb.) Kindb. new to Yugoslavia and some notes on the genus *Rhodobryum* (Schimp.) Limpr. in Yugoslavia. *Ekologija* 36(2): 145–153.
18. **Sabovljević, M.** and Sérgio, C. 2002. Contribution to the bryoflora of Serbia: a bryophyte collection from 1996. *Portugaliae Acta Biologica* 20: 65–74.
19. Marjanović, Ž and **Sabovljević, M.** 2002. Biljni svet i gljive u klisuri reke Gradac. – In: Janevski, B. (ed.) Reka Gradac – monografija: 91–94. (Plants and fungi of the river Gradac gorge). (in Serbian)
20. Marjanović, Ž and **Sabovljević, M.** 2002. Sumske sastojine sliva reke Gradac. – In: Janevski, B. (ed.) Reka Gradac – monografija: 97. (Forests of the river Gradac gorge). (in Serbian)
21. Blockeel, T. L., Ros, R. M., **Sabovljević, M.**, Cano, M.J., Gallego, M.T., and Muñoz, J. 2002. New and interesting bryophyte records for Greece. *Cryptogamie, Bryologie* 23(2): 149–155.
22. **Sabovljević, M.** 2002. Bryophytes of South Banat (Vojvodina, Serbia). *Bulletin of the Bryological Society* 79: 37–38.
23. Papp, B. and **Sabovljević, M.** 2002. The Bryophyte Flora of Tara National Park (W Serbia, Yugoslavia). *Studia Botanica Hungarica* 33: 25–39.
24. **Sabovljević, M.**, Bijelović, A. and Dragičević, I. 2002. Effective and easy way of establishing *in vitro* culture of mosses, *Bryum argenteum* Hedw. and *Bryum capillare* Hedw. (*Bryaceae*). *Archive of Biological Sciences, Belgrade* 54(1-2): 7P-8P.
25. Blockeel, T.L., Arts, T., Bruggeman-Nannenga, M. A., Brusa, G., Hedenäs, L., Novotný, I., Ochyra, M. S., **Sabovljević, M. S.** and Townsend C. C. 2003. New national and regional bryophyte records, 6. *Journal of Bryology* 24(4): 329–332.
26. **Sabovljević, M.**, Bijelović, A. and Dragičević, I. 2003. *In vitro* culture of mosses: *Aloina aloides* (K.F. Schultz) Kindb., *Brachythecium velutinum* (Hedw.) B.S.&G., *Ceratodon purpureus* (Hedw.) Brid., *Eurhynchium praelongum* (Hedw.) B.S.&G. and *Grimmia pulvinata* (Hedw.) Sm. *Turkish Journal of Botany* 27: 441–446.
27. Aleffi, M., **Sabovljević, M.** and Tacchi, R. 2003. *Didymodon sicculus* M. J. Cano, Ros, García-Zamora & J. Guerra (*Pottiaceae*, Musci), new to Italy. *Cryptogamie, Bryologie* 24(1): 49–51.
28. **Sabovljević, M.** 2003. Bryophyte flora of South Banat. (Vojvodina, Yugoslavia) *Cryptogamie, Bryologie* 24(3): 241 – 252.
29. **Sabovljević, M.** and Cvetic, T. 2003. Bryophyte flora of Avala Mt. (C. Serbia, Yugoslavia). *Lindbergia* 28: 90-96
30. **Sabovljević, M.** 2003. Donneés sur le présence et la chorologie des taxons du genre *Schistidium* Bruch & Schimper (*Grimmiaceae*) dans la République Fédérale de Yougoslavie (Serbie et Monténégro). *Bocconeia* 16(2): 991-999.
31. **Sabovljević, M.** 2003. The hepatic check list of Croatia. *Archive of Biological Sciences, Belgrade* 55(1-2): 59-66.
32. Bijelović, A. and **Sabovljević, M.** 2003. Callus induction and plant regeneration in the moss *Aloina aloides* (Schultz.) Kindb. (*Pottiaceae*, *Bryopsida*). *Archive of Biological Sciences, Belgrade* 55(3-4): 77-80.
33. Papp, B. and **Sabovljević, M.** 2003. Contribution to the bryophyte flora of Turkish Tharce. *Studia Botanica Hungarica* 34: 43–54.
34. Aleffi, M., **Sabovljević, M.** and Tacchi, R. 2003. Bryoflora of Monte Conero Regional Park (Marche, Italy). *Flora Mediterranea* 13: 151–171.
35. **Sabovljević, M.**, Cvetic, T. and Stevanović, V. 2004. Bryophyte Red List of Serbia and Montenegro. *Biodiversity and Conservation* 13: 1781-1790.
36. Bijelović, A., **Sabovljević, M.**, Grubišić, D. and Konjević, R. 2004. Phytohormone influence on the morphogenesis of two mosses (*Bryum argenteum* Hedw. and *Atrichum undulatum* (Hedw.) P. Beauv.). *Israel Journal of Plant Sciences* 52(1): 31-36.
37. Aleffi, M., **Sabovljević, M.** and Tacchi, R. 2004. *Gymnostomum lanceolatum* M.J.Cano, Ros & J. Guerra (*Pottiaceae*, Musci), new to Italy. *Cryptogamie, Bryologie* 25(2): 175-177.
38. Pocs, T., **Sabovljević, M.**, Puche, F., Segarra Moragues, J.G., Gimeno, C and Kürschner, H. 2004. *Crossidium laxifilamentosum* Frey and Kürschner (*Pottiaceae*), new to Europe and to North Africa. Studies on the cryptogamic vegetation on loess cliffs, VII. *Journal of Bryology* 26: 113-124.
39. **Sabovljević, M.** 2004. Comparison of the bryophyte flora of the three southern european mainlands: the Iberian, the Apennine and the Balkan peninsulas. *Braun-Blanquetia* 34: 21- 28.

40. Papp, B., Erzberger, P. and **Sabovljević, M.** 2004. Contribution to the bryophyte flora of Kopaonik Mts. (Serbia, Serbia-Montenegro). *Studia Botanica Hungarica* 35: 67–79.
41. **Sabovljević, M.** 2004. Life strategies of bryophytes on loess cliffs in Vojvodina (Serbia). *Archive of Biological Sciences* 56 (3-4): 127-130.
42. Vukojević, V., Sabovljević, A. and **Sabovljević, M.** 2004. Effect of ferri(III)citrate and potassium hexacyanoferrate(III) on growth of the moss *Bryum argenteum* Hedw. *in vitro*. *Archive of Biological Sciences* 56 (3-4): 75-78.
43. Cvetić, T. and **Sabovljević, M.** 2004. New and interesting bryophyte records for Montenegro. *Phytologia balcanica* 10 (2-3): 67-69.
44. Cvetić, T. and **Sabovljević, M.** 2005. A contribution to the bryophyte flora of Fruska Gora (Vojvodina, Serbia). *Phytologia balcanica* 11(1): 35-43.
45. Vukojević, V., **Sabovljević, M.** and Jovanović, S. 2005. Mosses accumulate heavy metals from the substrata of coal ash. *Archive of Biological Sciences* 57(2): 101-106.
46. Sabovljević, A., **Sabovljević, M.**, Grubišić, D. and Konjević, R. 2005. The effect of sugars on development of two moss species (*Bryum argenteum* and *Atrichum undulatum*) during *in vitro* culture. *Belgian Journal of Botany* 138(1): 79-84.
47. Šinžar-Sekulić, J., **Sabovljević, M.** and Stevanović, B. 2005. Comparison of desiccation tolerance among mosses from different habitats. *Archive of Biological Sciences* 57(3): 189-192.
48. **Sabovljević, M.**, Vukojević, V., Mihajlović, N., Dražić, G. and Vučinić, Ž. 2005. Determination of heavy metal deposition in the county of Obrenovac (Serbia) using mosses as bioindicators. I: Aluminium (Al), Arsenic (As) and Boron (B). *Archive of Biological Sciences* 57(3): 205-212.
49. Cvetić, T., **Sabovljević, M.**, Sabovljević, A. and Grubišić, D. 2005. *In vitro* culture and apogamy – alternative pathway in life cycle of the moss *Amblystegium serpens* (Amblystegiaceae). *Archive of Biological Sciences* 57(4): 267-272.
50. Sabovljević, A., Soković, M., **Sabovljević, M.** and Grubišić, D. 2006. Antimicrobial activity of *Bryum argenteum*. *Fitoterapia* 77(2): 144-145.
51. Frahm, J.-P. and **Sabovljević, M.** 2006.. *Sphagnum denticulatum* var. *monocladum* , a new taxon from the Azores, with notes on *Sphagnum monocladum* Warnst. *Tropical Bryology* 27: 113-119.
52. **Sabovljević, M.** 2006. Contribution to the bryophyte flora of the Djerdap National Park (E. Serbia). *Phytologia Balcanica* 12(1): 51-54.
53. **Sabovljević, M.** 2006. Contribution to the bryophyte flora of the Western Alps (Italy, France). *Archive of Biological Sciences* 58: 61-64.
54. **Sabovljević, M.** 2006. The check list of mosses of Croatia. *Archive of Biological Sciences* 58: 45-53.
55. Vukojević, V., **Sabovljević, M.**, Sabovljević, A., Mihajlović, N., Dražić, G. and Vučinić, Ž. 2006. Heavy metal deposition in the county of Obrenovac (Serbia) using mosses as bioindicators II: Cadmium (Cd), Cobalt (Co) and Chromium (Cr). *Archive of Biological Sciences* 58: 95-104.
56. **Sabovljević, M.** and Stevanović, V. 2006. Contribution to the bryophyte flora of Bačka (Vojvodina, Serbia). *Archive of Biological Sciences* 58: 135-138.
57. Sabovljević, A., Cvetić, T. and **Sabovljević, M.** 2006. The establishment and development of the Catherine's moss *Atrichum undulatum* (Hedw.) P.Beauv. (Polytrichaceae) in *in vitro* conditions. *Archive of Biological Sciences* 58: 87-93
58. Colacino, C. and **Sabovljević, M.** *In press*. Check list of the bryophytes of Albania. *Cryptogamie-Bryologie*
59. **Sabovljević, M.** and Natcheva, R. *In press*. Check list of the liverworts and hornworts of South-Eastern Europe. *Phytologia Balcanica*
60. Frahm, J.-P. and **Sabovljević, M.** *In press*. Preliminary results of the taxonomic value of *Tortula densa* (Velen.) J.-P. Frahm inferred from the Internal Transcribed Spacer (ITS) of the nrDNA. *Cryptogamie-Bryologie*

Further references:

41 communications in International Meetings and 4 chapter in Popular Scientific Journals

Selected Fellowships and Prises:

1. Petnica Science Center Fellowships (2)
2. Serbian Ministry of Education and Science – Fund for Talented Youth
3. SOROS Open Society Fellowship
4. University of Murcia, Spain – Grant for Language and Culture Studies in Spain
5. Italian Government – Grant for foreign Scientists
6. Serbian Nature Protection Institute Prize for Achievement in Nature Protection

7. DAAD Fellowships (2)
8. GEF RUB
9. Ford Motor Company Prize for for the Environment and Protection of Natural Heritage
10. Warburg Memorial Fund (BBS) fellowship
11. Bequest Foundation Fellowships (2)
12. Bryo-Planet Fellowships (6)

Languages: English (active), Spanish (active), Italian (active), German (active), French (active), Portuguese (active), Turkish (basic), Russian (basic), Catalan (basic), Serbian, Croatian, Bosnian, Montenegrin, Macedonian, Bulgarian, Slovenian

International Activities and Responsibilities:

1. member in 11 bryological national and international societies and working groups
2. contact person of The European Committee for Conservation of Bryophytes (ECCB) for the Federal Republic of Yugoslavia region (since 1996),
3. member of ECCB board (since 1999) and CP secretary (since 2004)
4. member of Bryophyte Commission of OPTIMA (Organization for PhytoTaxonomical Investigation in the Mediterranean Area) (since 2002).
5. member and president of The Bryological Association of South Eastern Europe (since 2002).
www.bryo-see.org.yu
6. Reviewer in International Scientific Journals:
 1. Phytologia Balcanica, Sofia
 2. Cryptogamie-Bryologie, Paris
 3. Hacquetia, Ljubljana
 4. Archives of Biological Sciences, Belgrade
 5. Bocconeia, Palermo

Scientific studying stay (up to three months):

Two months in Spain, learning the methods in Bryology, Universidad de Murcia, Facultad de Biología, Laboratorio de Biología supervising by Profa. Dra. Rosa María Ros Espín (may, june 1999)
 One week in Spain, working on taxonomy of the genus Schistidium, Universidad de Murcia, Facultad de Biología, Laboratorio de Biología supervising by Prof. Dr. Hans Blom (september, 2000)
 One week in Spain, working on taxonomy of the genus Grimmia, Real Jardín Botánico, Laboratorio de Criptogamia, Madrid supervising by Dr. Jesús Muñoz (september, 2000)
 One week in Portugal, working on bryological material from Serbia, in Laboratory of Bryology of Museu, Laboratório e Jardim Botânico / Centro de Ecologia e Biologia Vegetal, Universidade de Lisboa supervising by Dra. Cecília Sérgio (september, 2000)
 Three months in Laboratory of bryology, Dipartimento di Botanica ed Ecologia, Università di Camerino, Marche, Italy (April – June, 2002)
 Three months in Laboratory of Bryophyte Molecular Biology, (AG Bryologie), Botanisches Institut des Friedrich Wilhelms Universität Bonn, Germany (January- March, 2003)
 One week in University of Lund, Sweden – Cryptogam Molecular Markers (October, 2003)

Skilfulness and achievements:

Biological:

1. DNA isolation
2. RNA isolation
3. cDNA synthesis
4. PCR
5. RT-PCR
6. TAIL-PCR
7. gene cloning in different vectors
8. protoplast isolation and transformation
9. fluorescent microscopy
10. plant tissue culture
11. atomic absorption
- 12.
13. spectrophotometre

and manipulation within the following softwares:

1. Chromas
2. Alignment
3. Cluster W
4. T Coffee
5. PAUP
6. GenBank (EMBL)
7. BLAST

Non-biological:

Clean Drive Licence
 Military Service
 Certificado de Cultura y Lengua Espanola, Facultad de Letras, Universidad de Murcia, Espana (9 sobre 10) nivel avanzado
 Certificate of Turkish Language, (1+, the highest mark in Germany), University of Cologne.

Eidesstattliche Erklärung:

An Eides statt versichere ich, dass ich diese Arbeit selbst und ohne jede unerlaubte Hilfe angefertigt habe, und dass ich diese oder ähnliche Arbeit noch keiner anderen Stelle zur Prüfung vorgelegt habe.

Marko Sabovljević

Bonn, Juli 2006