

**Development of a new method to identify parameters  
affecting the microbial reduction in domestic dishwashers**

**Dissertation**

zur Erlangung des Grades

Doktorin der Ernährungs- und Lebensmittelwissenschaften (Dr. troph.)

der Landwirtschaftlichen Fakultät

der Rheinischen Friedrich-Wilhelms-Universität Bonn

von

**Britta Brands**

aus

Kleve

Bonn 2021

Referent: Professor Dr. André Lipski

Korreferent: Professor Dr. Dirk Bockmühl

Tag der mündlichen Prüfung: 01. Juli 2021

Angefertigt mit Genehmigung der Landwirtschaftlichen Fakultät der Universität Bonn

## Zusammenfassung

Das Geschirrspülen hat zum Ziel, die benutzten Gegenstände zu säubern. Neben der Entfernung von Speiseresten geht es dabei auch um die Reduktionen mikrobieller Kontaminationen auf Geschirr und Besteck, so dass diese unter die infektiöse Dosis reduziert werden.

Schon seit langem ist bekannt, dass das Spülen mit einem voll belegten Geschirrspüler effizienter ist als das Geschirrspülen von Hand und so deutlich weniger Energie und Wasser verbraucht werden. Zudem wurde gezeigt, dass die mikrobielle Reduktion im Geschirrspüler höher ist als beim Handgeschirrspülen. Hierbei ist allerdings zu beachten, dass diese Aussagen getroffen wurden, als die durchschnittlichen Temperaturen beim Maschinen-Geschirrspülen bei 60 °C und mehr lagen.

Durch den anhaltenden Trend und den steigenden Druck auf die Gerätehersteller, immer weniger Energie und Wasser zu verbrauchen, um bei der Einstufung nach dem EU-Energielabel gute Effizienzklassen zu erzielen stellte sich die Frage, welche Auswirkungen dies auf die mikrobielle Reduktion hat.

Da es bisher keine standardisierte Methode zur Identifizierung der Parameter gab, die die mikrobielle Reduktion in Haushalts-Geschirrspülmaschinen bestimmen, war das Ziel, eine solche Methode zu entwickeln. Gleichzeitig sollte bei der Entwicklung darauf geachtet werden, dass diese Methode in möglichst vielen Laboratorien genutzt werden kann und so sollte nicht der für die Testung von gewerblichen Geschirrspülmaschinen etablierte Stamm *Enterococcus faecium* DSM 2146 genutzt werden, da dieser nur in Laboratorien mit der Freigabe zur Arbeit mit Organismen der Bio-Sicherheitsstufe 2 verwendet werden darf.

Es wurde mit *Micrococcus luteus* DSM 1790 ein alternativer Testkeim der Bio-Sicherheitsstufe 1 identifiziert, der vergleichbare Reduktionen zeigt und in manchen Punkten sogar eine bessere Differenzierbarkeit bietet. Eine systematische Analyse von Reinigungszyklen in einem speziell programmierten Geschirrspüler zeigte, dass die Faktoren Reinigungs- und Klarspültemperatur, Reinigungsdauer und die Nutzung von Geschirrspülmittel verschiedener Formulierungen die Keimreduktion allesamt beeinflussen. Dabei zeigte sich, dass insbesondere bei niedrigen Temperaturen und kurzen Zyklen die verbleibende Keimzahl steigt.

Daher ist eine regelmäßige Reinigung bei hohen Temperaturen empfehlenswert, um einen hygienisch unbedenklichen Status sowohl des Geschirrs als auch der Geschirrspülmaschine sicherzustellen.



## **Abstract**

The purpose of dishwashing is to clean the items used. In addition to the removal of food residues, the aim is to reduce microbial contamination on dishes and cutlery so that it is reduced below the infectious dose.

It has long been known that washing dishes with a fully loaded dishwasher is more efficient than washing them by hand, and thus uses significantly less energy and water.

It has also been shown that the microbial reduction in the dishwasher is higher than in hand dishwashing. It should be noted, however, that these statements were made when the average temperatures during machine dishwashing were 60 °C and higher.

The continuing trend and increasing pressure on appliance manufacturers to use less and less energy and water in order to achieve good efficiency classes in the classification according to the EU energy label raised the question of what effect this has on the microbial reduction.

As there was no standardised method for identifying the parameters that determine the microbial reduction in household dishwashers until now, the aim was to develop such a method. At the same time, care should be taken during the development to ensure that this method can be used in as many laboratories as possible. For this reason, the strain *Enterococcus faecium* DSM 2146, which is established for testing commercial dishwashers, should not be used, as this strain may only be handled in laboratories with the approval to work with organisms of biosafety-level 2.

With *Micrococcus luteus* DSM 1790, an alternative test organism of biosafety-level 1 was identified which shows comparable reductions and in some points even offers better differentiation. A systematic analysis of cleaning cycles in a specially programmed dishwasher showed that the factors cleaning and rinse temperature, cleaning duration and the use of dishwashing detergent of different formulations all influence the reduction of microorganisms. It was shown that the remaining bacterial count increases especially at low temperatures and short cycles.

Therefore, regular cleaning at high temperatures is recommended to ensure a hygienically safe status of both the dishes and the dishwasher.



**Table of contents**

List of abbreviations.....	IV
1. Background.....	1
1.1. Hygiene of food contact surfaces.....	4
1.2. Dishwashing.....	4
1.2.1. Manual Dishwashing.....	5
1.2.2. Automated Dishwashing.....	6
1.3. Factors influencing the antimicrobial efficacy in dishwashing.....	10
1.3.1. Cleaning cycle duration.....	11
1.3.2. Cleaning cycle temperature.....	11
1.3.3. Mechanical action in dishwashing.....	12
1.3.4. Detergents in automated dishwashing.....	12
1.4. Current standards and regulations in automated dishwashing.....	15
2. Objectives.....	21
3. Materials and methods.....	27
3.1. Test strains.....	27
3.1.1. <i>Micrococcus luteus</i> .....	30
3.1.2. <i>Enterococcus faecium</i> .....	31
3.1.3. <i>Staphylococcus aureus</i> .....	31
3.2. Cultivation of Microorganisms.....	31
3.3. Heat resistance testing.....	32
3.4. Soil matrix.....	32
3.4.1 Choice of the soil matrix.....	32
3.4.1 Preparation of the soil matrix BAMS.....	35
3.5. Preparation of the inoculation solution.....	36
3.6. Preparation of biomonitors.....	36
3.7. Dishwashing procedures.....	37
3.7.1. Dishwashing by hand.....	38
3.7.2. Simulation of dishwashing in the Tergotometer.....	38
3.7.3. Automated dishwashing.....	39
3.8. Determination of the microbial load.....	43
3.9. Calculation of the microbial reduction.....	44
3.9.1. Statistical analysis.....	46

3.9.2. Four-parameter logistic regression analysis .....	47
3.9.3. Linear regression analysis .....	47
3.9.4. Random forest analysis.....	48
3.10. Cross-contamination .....	48
4. Results.....	49
4.1. Pre-test results .....	49
4.1.1. Heat resistance testing .....	49
4.1.2. Choice of the soil matrix .....	50
4.1.3. Influence of the extraction parameters on the recovery of the microbial load.....	51
4.2. Influence factors in hand dishwashing.....	55
4.2.1. Temperature.....	56
4.2.2. Detergent .....	57
4.2.3. Duration.....	57
4.2.4. Mechanical action.....	58
4.3. Investigation of influence factors in the tergotometer .....	60
4.3.1. Temperature.....	70
4.3.2. Detergent .....	77
4.3.3. Duration.....	83
4.3.4. Mechanical action.....	88
4.4. Influence factors in household dishwashers.....	89
4.4.1. Temperature.....	94
4.4.2. Detergent .....	107
4.4.3. Duration.....	110
4.4.4. Mechanical action.....	112
4.5. Cross contamination.....	112
4.6. Round Robin tests (ring trial).....	114
5. Discussion.....	115
5.1. Choice of microorganisms .....	116
5.2. Biomonitor preparation and behaviour .....	117
5.3. The LR on biomonitors is a combination of removal and inactivation.....	119
5.4. Use of the standardized logarithmic reduction (SLR) instead of the logarithmic reduction (LR).....	119
5.5. Comparison between suspension tests, tergotometer and dishwasher tests.....	121
5.6. Effect of different factors on the reduction in dishwashing.....	125



5.6.1. Influence of the cleaning and rinsing temperatures .....	125
5.6.1.1. Four-parameter logistic regression .....	125
5.6.1.2. Linear regression .....	127
5.6.1.3. Identification of the factors with the highest influence by random forest analysis .....	128
5.6.2. Influence of the cleaning duration.....	130
5.6.3. Influence of the detergent.....	131
5.6.4. Influence of the mechanical action .....	132
5.7. Interaction of parameters in dishwasher tests .....	134
5.8. Quantity of ballast soil .....	142
5.9. Temperature profiles in automated dishwashers.....	142
5.10. Relevance .....	144
5.11. Future prospects .....	146
6. Conclusion .....	147
7. References.....	148
Appendix: List of figures .....	VIII
Appendix: List of tables .....	XIV
Appendix: Growth conditions for Microorganisms .....	XVI
Appendix: Culture media and other solutions.....	XVII
Tryptic soy broth (TSB) .....	XVII
Extraction liquid (EL).....	XVIII
Tryptic soy Agar (TSA).....	XVIII
Soil matrix BAMS .....	XIX
Physiological sodium chloride solution (0.9% NaCl) .....	XIX
Appendix: Detergent compositions .....	XX
Hand dishwashing detergent.....	XX
Reference detergent type D .....	XXI
Rinse aid III .....	XXII
Appendix: Materials and Devices .....	XXIII
Appendix: Matrix pre-test results.....	XXIX
Appendix: Full-size figures.....	XXXI
Acknowledgements – Danksagung .....	LXXVIII

**List of abbreviations**

%LR	percentage of the detected LR in relation to the maximum achievable LR
$\Delta LR_x$	The difference in LRs caused by a change in factor x
4PL	four-parameter logistic regression
$AE_C$	annual energy consumption of the household dishwasher in kWh/year rounded to two decimal places
ANOVA	Analysis of variance statistical models
ANSI	American National Standards Institute
AOB	(detergent containing) activated oxygen bleach
ATCC	American Type Culture Collection
$AW_C$	annual water consumption
BfR	Bundesinstitut für Risikobewertung (Federal Institute for Risk Assessment)
BSL	biosafety-level
CEN	European Committee for Standardization (Comité Européen de Normalisation)
cfu	colony forming units
cpm	cycles per minute
DAED	N-N'Diacethylenediamine
DIN	Deutsches Institut für Normung (German Institute for Standardisation)
DIN SPEC	a DIN SPEC is a standard document prepared under the direction of DIN, using the publicly available specification procedure.
DSM	catalogue numbers in the German collection of microorganisms and cell cultures all start with DSM followed by numbers to distinguish from other collections
DSMZ	Deutsche Sammlung von Mikroorganismen und Zellkulturen (German collection of microorganisms and cell cultures)
DT	bleach-free detergent
<i>e. g.</i>	exempli gratia (for example)
EEI	energy efficiency index

EG	German abbreviation for the European Community (EC)
EL	extraction liquid
EN	European standard
<i>EPEC</i>	measured eco programme energy consumption in kWh · cycle <sup>-1</sup> rounded to three decimal places
<i>EPWC</i>	Eco programme water consumption
<i>et al.</i>	<i>et alii</i> (and others)
EU	European Union
g	gravitational acceleration (~ 9.81 m·s <sup>-2</sup> )
gr-	Gram-negative
gr+	Gram-positive
h	hour(s)
HUE	heat unit equivalents: unit used in American standards to measure the time intervals above a critical temperature of 62 °C
<i>I<sub>D</sub></i>	drying efficiency index
IEC	International Electrotechnical Commission
ISO	International Organization for Standardization
kPa	Kilopascal (1 kPa = 1000 Pa = 0.1 N·cm <sup>-2</sup> )
kWh	kilowatt-hour
LR	logarithmic reduction (factor)
MEA	malt extract agar
MEB	malt extract broth
N	Newton
NaCl	Sodium chloride
ND	no detergent
NSF	National Sanitation Foundation
Pa	Pascal
pH	power/potential for hydrogen; negative decadic logarithm of the hydrogen ion concentration
ps	place settings
QB/T	Chinese National standards
rpm	revolutions per minute

---

<i>SAEC</i>	standard annual energy consumption of the household dishwasher based on number of place settings (ps) and width
SLR	Standardized logarithmic reduction (factor)
sp.	indication of a non-specific species (singular) of the named genus
<i>SPEC</i>	calculated standard programme energy consumption in kWh · cycle <sup>-1</sup> rounded to three decimal places depending on place settings
spp.	Indication of different species (plural) of the named genus
subsp.	subspecies
TAED	N-N-N'-N'Tetraacethylenediamine
TSA	tryptic soy agar
TSB	tryptic soy broth
U.H.T.	Ultra-High Temperature processing (to sterilize milk and other liquids)
UK	United Kingdom
WG	working group
WHO	World Health Organization
YOPI	short for young, old, pregnant and immunocompromised persons

## 1. Background

The term hygiene comes from the Greek. It is derived from Hygeia, one of the daughters of Asclepius (the god of medicine) and Epione (the goddess of healing). Hygeia was the goddess of health, cleanliness and sanitation. (Daly and Rengel, 2009; Delahunty and Dignen, 2010)

Today, hygiene covers all conditions or practices that maintain health and prevent diseases especially through cleanliness (Bährle-Rapp, 2012). This covers very diverse fields from personal and home hygiene to food hygiene and medical hygiene.

According to the World Health Organization (WHO), food hygiene covers all necessary conditions and measures to ensure the safety of food from production to consumption and to prevent food-borne diseases (“WHO | Food hygiene,” 2020). As microorganisms are found nearly everywhere in the environment, this is also true for materials that are meant to be used as food. There are different regulations for the production, treatment and placement of foodstuffs on the market that aim at the reduction of the microbial load and food safety and regulate the cleaning and disinfection measures during the production process (Das Europäische Parlament und der Rat der Europäischen Union, 2004; Deutsches Institut für Normung e. V., 2009; *Tierische Lebensmittel-Hygieneverordnung*, 2018, *Verordnung (EG) Nr. 178/2002 Des Europäischen Parlaments und des Rates vom 28. Januar 2002 zur Festlegung der allgemeinen Grundsätze und Anforderungen des Lebensmittelrechts, zur Errichtung der Europäischen Behörde für Lebensmittelsicherheit und zur Festl*, 2002, “*VERORDNUNG (EG) Nr. 2073/2005 DER KOMMISSION über mikrobiologische Kriterien für Lebensmittel*,” 2013).

The microbial load of different foodstuffs differs due to their origin and the treatment. Some foodstuffs are classified as high-risk foods that are not suitable for certain groups of people. These include young, old, immunocompromised and pregnant women (YOPI). In 2015, the German Federal Institute for Risk Assessment (BfR) has published a guide for safe catering in community facilities and recommends to refrain from distributing certain foodstuffs to the YOPIs. These foodstuffs include dairy products and soft cheese made from raw milk, raw minced meat and raw meat cuts, raw sausages, unprocessed fishery products or shellfish, smoked fishery products, gravled salmon, sprouts and frozen berries. (Bundesinstitut für Risikobewertung, 2015)

All of these products can contain microorganisms that could act as pathogens and become especially dangerous for the YOPIs due to their reduced immune response. The group of microorganisms is diverse and depends on the respective food. Each food can contain specific

spoilage organisms and infectious as well as intoxicating agents. Food spoilage can be caused by several living organisms, *e.g.* moulds, yeasts and bacteria. (Baumgart, 2004; Haas *et al.*, 2014)

Some moulds produce mycotoxins, small molecules that can cause severe conditions humans after uptake. Of these, aflatoxins, *Fusarium* toxins and Ochratoxin are those with most relevance (Cole and Cox, 1981; Hassan *et al.*, 2019; Huang *et al.*, 2019; Klingelhöfer *et al.*, 2020). Some of these organisms have been detected in dishwashers (Babič *et al.*, 2015; Zalar *et al.*, 2011; Zupančič *et al.*, 2016).

Food of animal origin as well as plant origin can also contain different kinds of bacteria. In food of animal origin, these are often part of the microbiome of the living animal. Some of these bacteria, like *Campylobacter* spp. or *Salmonella* spp. are examples of the animal's natural intestinal flora. While in the intestines they do not harm the living animal but can be transferred to the meat during the production process. There they can survive (*Campylobacter* spp.) for a certain period of time or grow (*Salmonella* spp.). If the meat is not properly prepared, some bacteria can survive and cause diseases in humans. In 2019, a total of 13082 cases of Salmonellosis and 59039 cases of Campylobacter enteritis were registered in Germany (Robert-Koch-Institut, 2020). In plant food, like mixed salads, other microorganisms can be found. An overview of some relevant food-associated microorganisms is given in Table 1. These and other microorganisms can be spread to food contact surfaces during preparation.

**Table 1: Overview of microorganisms found in different foodstuffs.**

<i>Acinetobacter</i> spp.	<i>E. coli</i> (verocytotoxin forming and enterovirulent strains)	<i>Psychrobacter</i> spp. (e.g. <i>Psychrobacter immobilis</i> )
<i>Acrobacter cryaerophilus</i>	<i>Enterococcus</i> spp. (e.g. <i>Ent. agglomerans</i> )	<i>Rhizopus</i> spp.
<i>Aeromonas</i> spp. (e.g. <i>Aeromonas hydrophila</i> )	<i>Flavobacterium</i> spp.	<i>Salmonella</i> spp. (especially Serovars Enteritidis, Typhimurium, Hadar, Infantis and Virchow)
<i>Alcaligenes</i> spp.	<i>Fusarium</i> spp.	<i>Serratia</i> spp. (e.g. <i>S. liquefaciens</i> , <i>S. marcescens</i> )
<i>Arcobacter</i> spp. (e.g. <i>Arcobacter butzleri</i> )	<i>Hafnia alvei</i>	<i>Shewanella</i> spp. (e.g. <i>Sh. putrefaciens</i> , <i>Sh. baltica</i> , <i>Sh. hafniensis</i> , <i>Sh. morhuae</i> )
<i>Bacillus</i> spp. (e.g. <i>Bacillus cereus</i> )	<i>Klebsiella</i> spp.	<i>Shigella</i> spp.
<i>Botrytis</i> spp.	<i>Kurthia</i> spp. (e.g. <i>Kurthia zopfii</i> )	<i>Sporotrichum carnis</i>
<i>Brochothrix thermosphacta</i>	<i>Lactobacillus</i> spp. (e.g. <i>L. raffinolactis</i> )	<i>Staphylococcus</i> spp. (e.g. <i>S. aureus</i> )
<i>Campylobacter</i> spp. (e.g. <i>C. coli</i> , <i>C. jejuni</i> )	<i>Leuconostoc</i> spp.	<i>Streptococcus agalactiae</i>
<i>Candida</i> spp. (e.g. <i>C. glabrata</i> , <i>C. lipolytica</i> , <i>C. zeylanoides</i> )	<i>Listeria monocytogenes</i>	<i>Thamnidium</i> spp.
<i>Carnobacterium</i> spp.	<i>Micrococcus</i> spp.	<i>Vibrio</i> spp. (e.g. <i>V. parahaemolyticus</i> , <i>V. vulnificus</i> , <i>V. cholerae</i> -O1-strains)
<i>Citrobacter</i> spp.	<i>Monilia</i> spp.	<i>Weissella hellenica</i>
<i>Cladosporium</i> spp.	<i>Moraxella</i> spp.	<i>Yarrowia lipolytica</i>
<i>Clostridium</i> spp. (e.g. <i>C. perfringens</i> , <i>C. estertheticum</i> , <i>C. frigidicarnis</i> , <i>C. botulinum</i> type E/ non-proteolytic strains of types B and F)	<i>Morganella morganii</i>	<i>Yersinia enterocolitica</i>
<i>Corynebacterium</i> spp.	<i>Mucor</i> spp.	
<i>Cryptococcus laurentii</i>	<i>Pantoea agglomerans</i>	
	<i>Pediococcus</i> spp.	
	<i>Penicillium</i> spp.	
	<i>Photobacterium phosphoreum</i>	
	<i>Plesiomonas shigelloides</i>	
	<i>Providencia aerogenes</i>	
	<i>Pseudomonas</i> spp.,	

(Bartelt *et al.*, 2008; Bauer *et al.*, 2006; Betts Gail D. and Everis Linda, 2007; Corry, 2007b, 2007a; Frank, 2007; García-Gimeno and Zurera-Cosano, 1997; Griffiths, 2000; Heller, 2006; Huss, 1997; International Commission on Microbiological Specifications for Foods (ICMSF), 2019b, 2019a; Jay *et al.*, 2005; Klein and Bartelt, 2008; Lack *et al.*, 1995; Lindblad *et al.*, 2006, 2007; Lubber *et al.*, 2006; Nychas *et al.*, 2007; Otte-Südi, 2006b, 2006a; Reuter, 2008; Riemelt and Bartel, 2003; Samelis *et al.*, 2006; Samelis and de W. Blackburn, 2006; Satomi *et al.*, 2006, 2007; Scherer *et al.*, 2006; Scullion *et al.*, 2006; Teuber, 1987; Vihavainen *et al.*, 2007; Vogel *et al.*, 2005; Weber, 2008b, 2008a; Wegner and Weber, 2006; Weise, 2008; Zickrick and Weber, 2006)

### 1.1. Hygiene of food contact surfaces

Already in 1978, a British study identified three potential main sources of infection in the home: general wet and dry areas, food borne contaminations and contaminations by contact with humans or pets. The infection risk from dry areas, such as walls, floors, furniture or clothing was identified as very low, as most bacteria do not survive on them for a longer period of time. The infection risk via wet areas, such as sinks, drains, but also food preparation areas is higher compared to the dry areas. (Bloomfield, 1978)

The microbial contamination of typical spots and utensils in the home was analysed in British homes (Scott *et al.*, 1982). They found high numbers of microorganisms on dishcloths and other wet cleaning utensils that may function as reservoirs but also as dissemination sources for contamination in the kitchen.

Cross-contamination from food to surfaces and then to other foods was reported to be of less importance than poor temperature control of uncooked food (Roberts, 1990), but was still responsible for 14% of UK human salmonellosis outbreaks (Roberts, 1982). After preparation of infected chicken, *Salmonella* spp. counts of up to  $10^3$  cfu/5 cm<sup>2</sup> were found on chopping boards (Cogan *et al.*, 2002).

Even though microorganisms like *Salmonella* spp. can be removed from chopping boards by rinsing, the amounts of remaining bacteria are sufficient to cause food poisoning. Wooden surfaces show less removal of microorganisms than plastic ones and on plastic, scoring also reduced the removal of microbial cells. (Gough and Dodd, 1998)

One of the important factors to reduce the number of microorganisms on cooking utensils is dishwashing.

### 1.2. Dishwashing

Dishwashing is the process of cleaning used tableware, cutlery and cooking utensils. Next to restoring the visible cleanliness, dishwashing is a means to reduce the number of bacteria and other possible pathogens on food contact surfaces. This can either be achieved by manual dishwashing or automated dishwashing.



### 1.2.1. Manual Dishwashing

There are several different methods for manual dishwashing. These include cleaning the goods under running water, submerging them in different water baths, pre-wetting soiled goods and intermediate rinsing steps. The amount of detergent used in these techniques vary from very little to ample use of detergent. (Berkholz *et al.*, 2010; Stamminger *et al.*, 2003, 2007)

Next to the consumption of water, energy and detergent. The microbial reduction has to be considered. Different studies have been carried out that investigate the development of the microbial counts during the hand dishwashing process.

In 1947, the dishwashing practices in New York restaurant were investigated and the washed utensils were investigated for their bacterial load. After the hand dishwashing process, only 10% of the cups and glasses were found to hold less than 100 bacteria per utensil, for cutlery this percentage was a bit higher with 35 to 36 percent (Kleinfeld and Buchbinder, 1947).

Blackmore investigated the microbial load on contaminated plates and the bacterial load on the towels used for drying. While a decrease of the bacterial load on the plates was found when clean towels were used in the drying step, a 7-fold increase was observed, when used towels were used. The bacterial load on the towels simultaneously increased to a 12-fold. (Blackmore *et al.*, 1983)

The use of sanitizing hand dishwashing detergents does not significantly reduce the bacterial count on sponges even when regularly applied, although increased concentrations above the recommended amount did slightly reduce the load (Kusumaningrum *et al.*, 2002).

Mattick *et al.* compared different cleaning practices in the household setting as well as the bacterial load in dishwater, on towels and surfaces in commercial settings. They found that the mean water temperature for hand dishwashing was higher in commercial settings than in home settings and that at the same time the microbial loads in the commercial setting were lower. Subsequent studies revealed that the reduction of *Salmonella* spp. was faster when the water temperature was higher, but that a proportion of the cleaned dishes still held bacteria and their numbers depended on as well the initial loads as the tested strain. In all test scenarios, they detected transfer of bacteria from contaminated to sterile dishes. This together with their finding that the reduction is much lower when towel-drying is used instead of air-drying poses a risk of transfer to clean dishes and other surfaces used for food preparation. (Mattick *et al.*, 2003a, 2003b)

The impact of the water temperature was confirmed by Ståhl Wernersson *et al.* and Johansson *et al.*. Both studies showed that the reductions were higher with higher temperatures in suspension tests as well as simulated dishwashing tests and concluded that temperatures of 55 °C and above are necessary for a 3-log reduction of viable cells in an adequate time for hand dishwashing while spores of *B. cereus* were not reduced at all with temperatures up to 65 °C. They also found that the nutrient level of the dishwashing water has an influence on the survival with higher survival rates at higher nutrient levels. Additionally, a higher pH of 9 compared to 7 aids in the reduction of the microbial load. (Johansson *et al.*, 2004; Ståhl Wernersson *et al.*, 2005, 2006)

Ihne compared the reductions in different dishwashing procedures. She found a transfer to sterile plates with all methods and all tested organisms. The sponges used for scrubbing held  $10^4$  to  $10^6$  bacteria after the dishwashing process depending on the temperature and organism used, but with generally higher numbers at lower temperatures. The reductions she found were around 3 logarithmic steps independent of the temperature used. With higher water temperatures, the bacterial load of the water tended to be lower. (Ihne, 2006)

This was basically confirmed by a study of Lee in 2007. Here a three-compartment dishwashing process was investigated, but a sanitizer was used in addition to detergent. The reduction was found to be higher in setups with a temperature of 43 °C compared to 24 °C and could further be increased with longer sanitization times. The form of the item to be cleaned also influenced the reduction; the simpler the surface was, the higher the reduction. (Lee *et al.*, 2007)

### **1.2.2. Automated Dishwashing**

The first device for mechanical dishwashing was registered by Joel Houghton in the USA in 1850. This device was driven by a hand crank and water was sprayed onto the tableware by the user. (Houghton, 1850)

In 1886, Josephine G. Cochran received a patent for an improved dishwasher, in which the soiled goods were cleaned under a continuous stream of soap-suds or hot water emerging from water-jet pipes connected to pumps and several racks for holding the goods. (Blattman, 2013; Cochran, 1886)

In Europe, the first electrically powered dishwasher was sold by Miele in 1929, the first fully automated front-loading dishwasher in 1960 (Miele Limited, 2009).

All automated dishwashers are appliances in which soiled tableware and cooking utensils are placed in one or more racks or baskets. After the start of the cleaning cycle, water is pumped into the appliance and heated up on the bottom of the appliance. The heated water is pumped into spray arms situated under the racks. These arms rotate driven by the force of the water emerging through the water jets. The water removes the soil from the goods. After rinsing with fresh water, warm air is used to dry the clean goods. Some devices use zeolite which absorbs humidity and releases heat resulting in a reduction of energy used for the drying process. The automated dishwashing process is also shown in Figure 1.

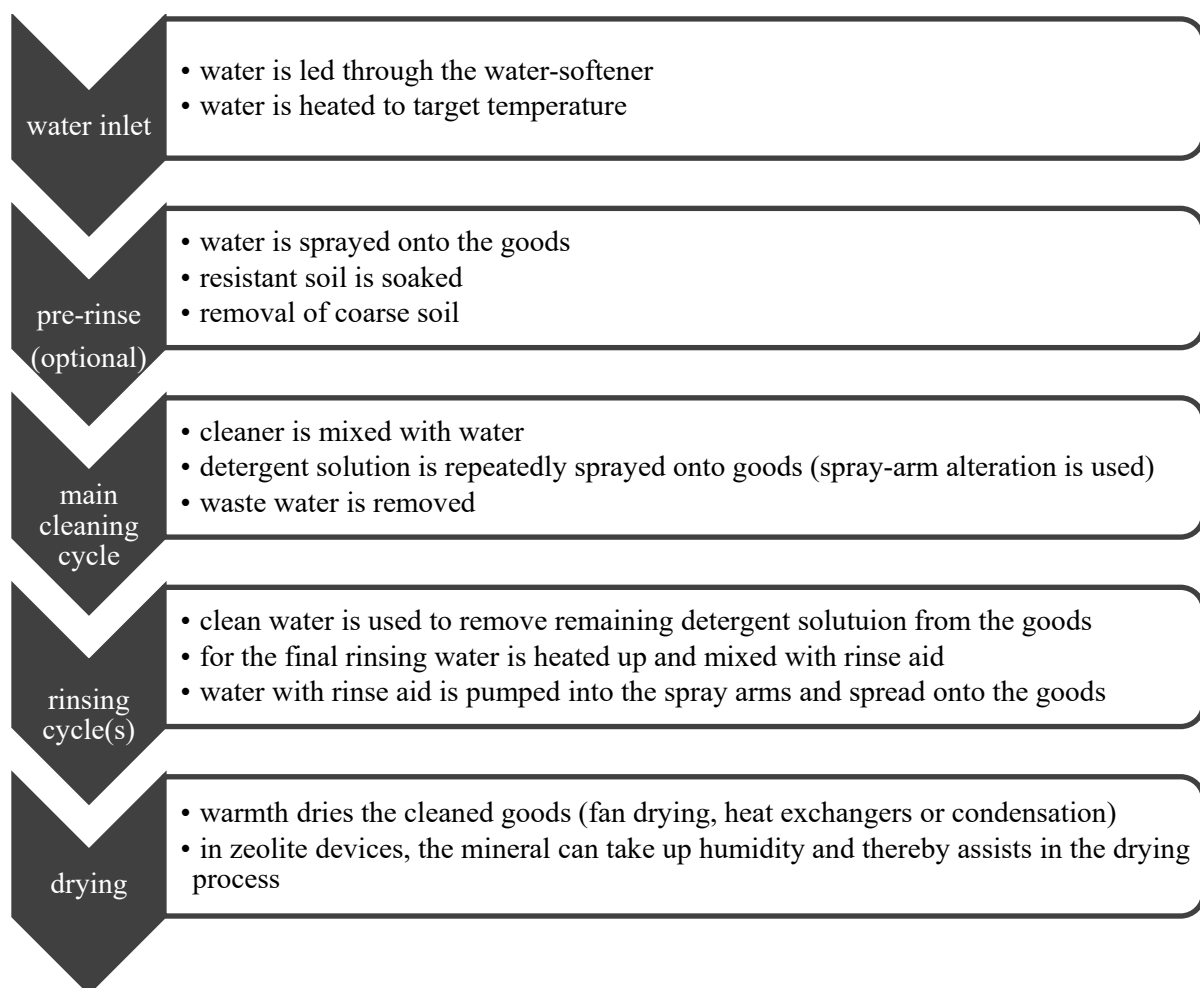

**Figure 1: Schematic overview of the automated dishwashing process.**

Recent automated dishwashers use programmes with different durations, temperatures and often have a sensor to control the turbidity of the water. The turbidity is used to estimate the remaining amount of dirt on the goods in the appliance and adjust the amount of water used and the duration of the cleaning cycle.

In Germany, the equipment of private households with automated dishwashers reached 71.7 % in 2019 (Statistisches Bundesamt, 2019). Recent automated dishwashers for domestic use can hold up to 14 place settings and clean those with as little as 8 L of water and do consume as little as 0.6 kWh of energy when the EU-Label cycle is used (Miele Limited, 2009).

Automated dishwashing is more efficient compared to manual dishwashing when it comes to consumption of energy and water, but consumers are not willing to use long-lasting cleaning cycles (Bansal *et al.*, 2011; Berkholz *et al.*, 2010; Brückner and Stamminger, 2014; Hook *et al.*, 2017; Richter, 2010, 2011; Stamminger *et al.*, 2007, 2018).

Automated dishwashers effectively remove soil from the goods (Patkavak, 2016; Peart and Johnston, 1976). They were shown to be more effective in removing bacteria from soiled tableware than dishwashing by hand. While 18.5% of the plates washed by hand had bacterial loads of 100 or more bacteria per piece, none of the plates cleaned in dishwashers was proven to hold that bacterial load. (McNeil *et al.*, 1965) The cleaning efficiency can further be optimized by using plastic granules to add more mechanical action in commercially used appliances (Ståhl Wernersson *et al.*, 2004a).

The hygiene in domestic dishwashers has been investigated in different studies. The automated dishwasher is more effective in the removal of bacteria from domestic crockery than manual dishwashing (Blackmore *et al.*, 1983; McNeil *et al.*, 1965) and is able to reduce the amount of bacteria on artificially soiled goods (Ward and Dack, 1939).

The use of domestic dishwashers to disinfect medical equipment has been investigated, showing the ability to reduce bacterial as well as viral contaminations from stainless steel surfaces. A modified domestic dishwasher with a cleaning temperature of 71 °C and a cleaner approved for medical use was able to completely reduce the load of *Enterococcus faecium* which was embedded in different soils on 98% of the stainless-steel screws used as test specimen. Test specimen with Parvovirus embedded in sheep blood allowed for detection of infectious virus particles of the virus after cleaning from 4.7% of the test specimen. (Ebner *et al.*, 2000)

On the other hand, cross-contamination to sterile plates was detected in a commercial one-tank dishwasher (Ståhl Wernersson *et al.*, 2004b) and opportunistic pathogens have been identified in domestic dishwashers. The majority of the detected fungal opportunistic pathogens were *Exophiala dermatitidis* and *Exophiala phaeomuriformis* (34.9% of the cases) and *Candida parapsilosis* (8.5% of the cases) which were mainly recovered from the rubber door sealings with loads of up to  $10^6$  cfu · cm<sup>-1</sup> (Babič *et al.*, 2017a, 2017b; Zalar *et al.*, 2011). The dishwasher was identified to be the major source of human opportunistic yeast-like fungi in indoor

environments in Mersin (Turkey), with 85.7% of the isolated from dishwashers being identified as *Exophiala spp.*, followed by *M. capitatus* (6.7%) and *Candida parapsilosis* (6.7%) (Döğen *et al.*, 2013). *Exophiala spp.* were also isolated from wastewater, side nozzles, doors and drains and were also detected on other kitchen surfaces in infected households (Zupančič *et al.*, 2016, 2018).

Next to different fungi, the rubber door seals are also colonized by different bacteria. With 65%, gram-positive bacteria dominated the bacterial communities and of these 65%, half of the load was detected to be *Bacillus spp.*, with *Bacillus cereus* being isolated from 80% of the sampled dishwashers and *Bacillus subtilis* from 43%. Metagenomic assessment also detected *Micrococcus spp.* (Raghupathi *et al.*, 2018; Zupančič *et al.*, 2018, 2019).

In prior research, the hygienic conditions in different types of domestic dishwashers have been analysed to evaluate the influence of different hygiene measures. A standard dishwasher with a 12 place-setting capacity, a cleaning temperature of 51 °C and a rinsing temperature of 48 °C has been compared to two appliances with a water reservoir. One of these appliances used a cleaning temperature of 62 °C, a standard rinsing temperature of 48 °C and had a special hygiene function in every 20<sup>th</sup> run in which a rinsing temperature of 78 °C was applied thrice. The third appliance used zeolite technology, had a standard cleaning temperature of 51 °C and used a cleaning temperature of 65 °C and an additional rinsing step of 60 °C in the hygiene programme. All devices were contaminated with *Bacillus subtilis* and *Pseudomonas fluorescens* embedded in margarine on plates. Samples were taken 1 h and 20 h after the end of the cleaning cycle from the sump and plates. In less than 10 % of the test cycles, five or more cfu · 25 cm<sup>-1</sup> have been detected on the plates. The microbial load in the sump is generally lower 1 h after the end of the cycle than 20 h after the end, but it rises over the test period in all the appliances. Special hygiene measures were able to retard the build-up and reduce the microbial load. (Brands and Bockmühl, 2015)

A study with two panels of dishwashers operating with different rinsing temperatures was compared. One panel used rinsing temperatures below 45 °C, the other panel used rinsing temperatures above 45 °C. Both panels of dishwashers were cleaned and then ran 25 cycles in the eco-programme using the same detergent. After the 25 cycles, the water in the sump, and the interior walls were sampled. The mean count in the sump as well as the count on the walls (used as indicator for the dish hygiene) was significantly higher in dishwashers with lower rinsing temperatures. The amount of *Enterobacteriaceae* identified on the walls was significantly higher in dishwashers operating with lower rinsing temperatures and additionally,

more of the dishwashers with lower temperatures were colonized by them. Additionally, of 168 dishwashers in Germany samples were taken from the sump and the interior walls. From the sump samples, metagenomic assessment for both bacteria and fungi was performed to picture the microbial communities in dishwashers. In sumps of dishwashers with shorter downtime since the last cycle, fungi are more abundant and their number decreases with time. As found before, also in this study the genera *Exophiala* and *Candida* are the predominant fungi, while the most predominant bacterial groups are *Pseudomonales*, *Enterobacterales* and *Bacteroidetes*. (Brands *et al.*, 2016b)

The findings from these studies suggest that the cleaning cycle temperature does affect the antimicrobial efficacy of the dishwashing process, but temperature is not the only factor that is involved in the microbial reduction on the cleaned tableware.

### **1.3. Factors influencing the antimicrobial efficacy in dishwashing**

In 1960, Herbert Sinner published his work “Über das Waschen mit Haushaltwaschmaschinen”. Here, he stated that for each laundering cycle, four factors play a role: time, temperature, mechanics and chemistry. He first used a pie chart to represent the influence of each of these factors and compared the then usual cooking of laundry in a tub with the laundry process in a household washing machine. (Sinner, 1960)

Sinner’s principle is still used to briefly describe the interaction of different parameters in laundry processes, but can also be used to describe other cleaning processes in which different parameters interact.

In dishwashing the same factors as in laundry are interacting to give a certain cleaning result. To just have a look at two of the factors, the temperature in automated dishwashing is higher compared to manual dishwashing (at least in certain process steps) while the mechanical component in automated dishwashers is lower when compared to intense manual scrubbing of the cleaned goods.

In automated dishwashing, the four factors are closely interacting. So, a change in one of the factors, might also lead to a change in one of the other factors without specifically changing

that factor. This is for example true for a change in the factor temperature. When the cleaning temperature is higher, it takes longer to heat up the water, resulting in an increased duration of the cleaning cycle without specifically choosing for this elongation. The four factors are now considered in more detail.

### **1.3.1. Cleaning cycle duration**

The impact of the cleaning cycle duration in automated dishwashing has not been studied in detail thus far. Dishwashing can, at least in parts be compared to thermal disinfection processes. In these processes, the duration (or time) is relevant for procedures as described in the  $A_0$  concept. This concept shows that the time necessary for disinfection interacts with the factor temperature. The higher the temperature, the shorter the duration that is required for disinfection. If lower temperatures are used, this can be compensated by a prolongation of the time in disinfection processes. In the original  $A_0$  concept, the lower temperature limit is given to be 65 °C. (Rosenberg, 2003)

Time is also an important factor in chemical disinfection processes (Rice *et al.*, 1999; Rutala and Weber, 2004) and has also been proven to be of importance for activated oxygen bleach systems in laundry (Betz, 2001; Brands *et al.*, 2016a). As the bleach system used in this thesis used the same bleach system, this is also true here.

With prolongation of the time, also the mechanical interaction of the water with the goods increases which might also contribute to the removal of the microbial load from the surface.

### **1.3.2. Cleaning cycle temperature**

As mentioned before, the temperature does influence the time needed for disinfection (Rosenberg, 2003). In dishwashers, an increase of the cleaning temperature from 51 °C to 62 °C and the rinsing temperature from 48 °C to 78 °C in special hygiene cycles can effectively reduce the microbial load found in the sump of the appliance (Brands and Bockmühl, 2015) and higher cleaning (increase from 30 °C to 65 °C) and rinsing temperatures (from 45 °C to 65 °C) led to a reduced viable cell count in artificially contaminated commercial dishwashers (Kerschgens *et al.*, 2016). Thus, the cleaning temperature has an impact on the reduction of the microbial load (Amberg, 2018; Ståhl Wernersson *et al.*, 2004b, 2005).

Due to the restrictions of the EU energy label, the cleaning and rinsing temperatures of the standard dishwasher cycles have been reduced in the recent years. Additionally, the dishwashers are programmed to automatically use the energy label programme when started.

Some recent dishwashers use main cleaning temperatures of 50 °C and rinsing temperatures of approximately 35 °C to 37 °C while others do use cleaning temperatures of 55 °C and rinsing temperatures of 45 °C (unpublished data recorded in several tests of appliances).

These differences in the temperature and the combination of different cycle parameters will influence the microbial reduction in the cleaning process and are thus included in the new method described in this thesis.

### **1.3.3. Mechanical action in dishwashing**

The mechanical action in automated dishwashing is directly dependent of the duration of the cleaning cycle. The longer the cleaning cycle takes, the more mechanical action is brought onto the goods by the operation of the spray arms. In most modern dishwashers in Europe spray-arm alternation is used to reduce the amount of water used in a single cycle, so only the upper or lower spray arm are active at a certain time point.

The water is pumped into the spray arms and leaves them through recoil jets at the end of the spray arm and additional nozzles in the spray arm. The water pressure thereby moves the spray arms and causes their rotation. This is used to reach all utensils to be cleaned in the dishwasher.

### **1.3.4. Detergents in automated dishwashing**

Detergents for automated dishwashing come as powder, tablets, caps, gel, all-in-one tablets or liquid tabs that are added for each cycle or as disc that is added to the appliance and doses the needed amount of powder detergent itself.

When classical tabs, powder or gel are used, rinse aid and salt for regeneration have to be added to the dishwasher separately.

The salt for regeneration is highly pure sodium chloride. During backwashing, it is used to remove calcium and magnesium ions from the ion exchange resin by a high sodium ion



concentration. During the cleaning process, calcium and magnesium are removed from the water to reduce the water hardness.

The rinse aid reduces the surface tension of the water and allows remaining water to run off without drop-forming and neutralizes alkaline residues from the cleaner (also see 1.3.4.2).

The dishwasher detergents contain enzymes to break down starch and protein residues, surfactants to wet the surface and remove the soil from it, pH regulating agents to obtain an alkaline pH, colouring and fragrances.

Non-liquid detergents additionally contain a bleaching component which is based on activated oxygen bleach.

The reference detergent used in this thesis contains the protease Savinase (Novozymes, Denmark), which works at low temperatures and is stable under high pH values and is used to break up protein residues. The amylase used in the detergent is Duramyl (Novozymes, Denmark) to break starch residues at medium temperatures (Novozymes, 2010).

Sodium citrate dihydrate, the sodium salt of citric acid is mildly basic in an aqueous solution. It is used as complexing agent, avoiding the formation of poorly soluble precipitations together with the major component sodium carbonate.

Maleic acid/acrylic acid copolymer sodium salt is a polymeric dispersing agent with the potential to inhibit incrustation and scale formation. It does this by dispersing suspended solids. In this way, soil particles that are removed from the surface can be washed off.

Sodium disilicate is soluble in water and forms an alkaline solution. The higher pH helps in removing the soil by a swelling process in mainly the protein-based soils. This swelling is necessary to replace the intense manual scrubbing that is used to remove soil in hand dishwashing.

Linear fatty alcohol ethoxylates with the chemical formula  $\text{CH}_3-(\text{CH}_2)_x-(\text{O}-\text{C}_2\text{H}_4)_y-\text{OH}$  (with  $x$  being an integer between 10 and 16 and  $y$  being an integer between 1 and 25) are low-foaming non-ionic surfactants. The surfactant forms micelles around water insoluble dirt particles as fat due to its amphiphilic nature. The micelles containing the dirt are then washed off the surface by the water stream.

### 1.3.4.1. Activated oxygen bleach in automated dishwashing

Throughout this thesis, reference detergent type D according to IEC 60436 was used (International Electrotechnical Commission, 2015) when referred to detergent containing activated oxygen bleach (AOB). The composition of the detergent is given in Appendix: Detergent compositions.

This detergent makes use of a bleaching system that is widely used in detergents for laundry and dishwashing alike in Europe and is also used in different standards to determine the cleaning performance of dishwashers for commercial use (Deutsches Institut für Normung e. V., 2008, 2019; Hauthal and Wagner, 2003).

The bleaching system makes use of sodium percarbonate which together with the bleach activator tetra acetyl ethylene diamine (TAED) releases peroxyacetic acid under alkaline conditions. Peracetic acid ions are formed which in turn oxidize the organic matter in the dishwashing process (Hauthal and Wagner, 2003; Milne, 1998; Sajitz and Grohmann, 2011) The working mechanism of the bleaching system is shown in Figure 2.

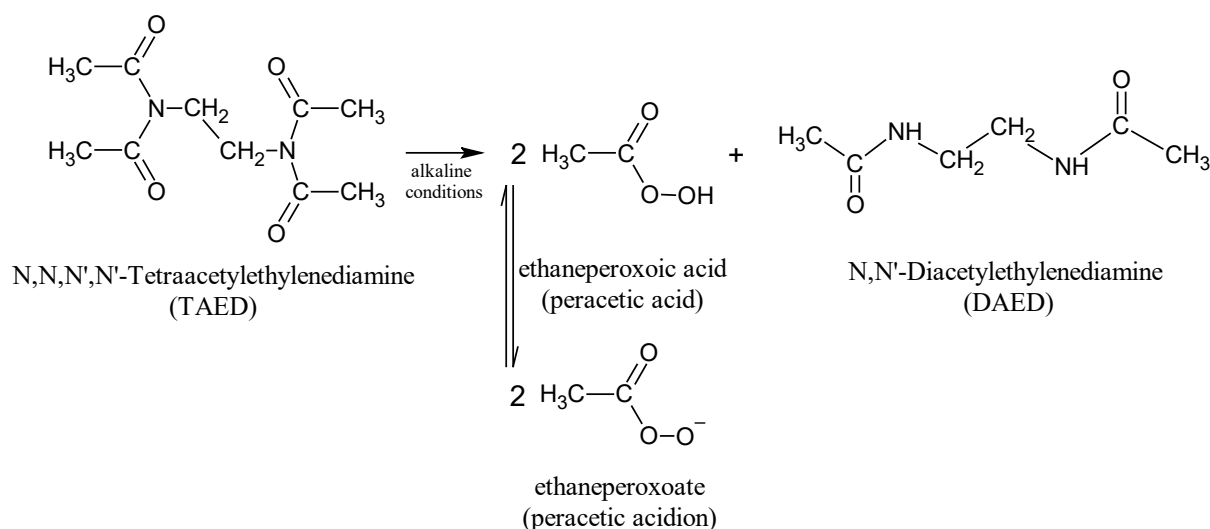

**Figure 2: The bleaching mechanism in detergents with activated oxygen bleach (modified after Hauthal and Wagner, 2003; Milne, 1998; Sajitz and Grohmann, 2011).**

#### 1.3.4.2. Rinse aid

The rinse aid in automated dishwashing mainly consists of a non-ionic surfactant and an organic acid in an aqueous solution. In commercially available rinse aids, fragrances, preservatives and solvents may also be present. The rinse aid is used to quickly wet the cleaned goods and to neutralise eventual remnants of the alkaline detergent. This leads to a quick drainage of remaining water and streak-free drying of the cleaned goods. (Hauthal and Wagner, 2003)

The composition of the rinse aid used throughout this thesis is given in Appendix. This rinse aid is highly acidic. A 1% solution in water results in a pH of 2.2. This might contribute to the reduction of the microbial load, but this aspect is not further investigated in this work.

### 1.4. Current standards and regulations in automated dishwashing

There are various standards worldwide that deal with automated dishwashers. In the United States, NSF/ANSI 184-2019 requires a minimum temperature of at least 66 °C in the sanitizing rinsing cycle, a microbial reduction of 5 logarithmic steps on the dish surface and a minimum of 3600 Heat Unit Equivalent (HUEs) during the sanitization rinse cycle to reach a certification as sanitizing appliance. The HUEs are calculated by adding HUE values given for certain temperatures for each 1s intervals with a continuous temperature above 62 °C (*NSF/ANSI 184-2019 - Residential Dishwashers*, 2019).

In China, QB/T 1520-2013 provides a test method for the cleaning performance as well as the bacterial reduction in household dishwashers. Dinner plates are loaded with bacterial cultures of *Escherichia coli* or *Staphylococcus aureus*. The plates are cleaned without detergent in the sanitation cycle and the eliminating bacteria rate in % is calculated (Light-Industry Standard of the People's Republic of China, 2013).

In Europe, there are currently no standards that regulate the hygiene for household dishwashers. IEC 60436 includes regulations to measure the cleaning performance, the drying performance, energy consumption, cycle and programme time of dishwashers for domestic use (International Electrotechnical Commission, 2015).

For commercially used dishwashers in Germany, there are several standards that regulate the hygiene, depending on the type of dishwasher used. These are DIN 10510, DIN 10511, DIN 10512, DIN 10522 and DIN SPEC 10534 (Deutsches Institut für Normung e. V., 1999, 2006a, 2013, 2019). In DIN 10511 dishwashers for glasses are regulated and DIN 10522

regulates dishwashers for multi-use boxes to transport foodstuff. DIN 10510 regulates multitank-transport dishwashers and DIN 10512 regulates commercial dishwashing in onetank-dishwashers.

DIN SPEC 10534 was released in February 2019 and generally covers hygiene requirements and the testing methods for several types of commercial dishwashers, thus including those covered by the other standards. Next to the regulations for installation, design and materials and methods for testing the cleaning performance, requirements and methods to test the microbial reduction are given.

This standard defines criteria for the different kinds of cleaned goods, stating that the microbial load per general item has to be less than  $5 \text{ cfu} \cdot 10 \text{ cm}^{-2}$ . For boxes used for the transport of food the maximum microbial load has to be below  $50 \text{ cfu} \cdot 10 \text{ cm}^{-2}$  and the load of yeasts and moulds has to be below  $2 \text{ cfu} \cdot 10 \text{ cm}^{-2}$  when boxes are used for critical food. When very critical food is transported, the total load has to be below  $10 \text{ cfu} \cdot 10 \text{ cm}^{-2}$  and *Enterobacteriaceae* must not be detectable on the surface.

The microbial reduction on glasses has to be at least 5 logarithmic steps for 90% of the glasses with the remaining 10% of the glasses showing at minimum reduction of 4 logarithmic steps.

Stainless steel biomonitors that are cleaned have to show log-reductions depending on their positioning in the dishwasher. When cleaned in the cutlery tray, seven of the eight tested biomonitors must show a logarithmic reduction of at least 5 steps and the remaining biomonitors of at least 4 steps. Those biomonitors that are mounted to transport trays of plates, 90% of the biomonitors must show a logarithmic reduction of 5 steps and the remaining 10% of at least 4 logarithmic steps. When the stainless steel biomonitors are mounted to a test rack, all of them have to show a logarithmic reduction of at least 5 logarithmic steps.

The direct comparison of the standards NSF/ANSI 184-2019, QB/T 1520-2013, IEC 60436-2015, and DIN SPEC 10534-2019 is given in Table 2. The table lists the soils used, the load, cycles that are tested and the test organisms used to measure the microbial reduction if present.

**Table 2: Overview of parameters measured, load, soil and if available microorganisms used in current standards for different types of dishwashers (Deutsches Institut für Normung e. V., 2019; International Electrotechnical Commission, 2015; Light-Industry Standard of the People’s Republic of China, 2013; NSF/ANSI 184-2019 - Residential Dishwashers, 2019)**

	<b>NSF/ANSI 184-2019</b>	<b>QB/T 1520-2013</b>	<b>IEC 60436-2015</b>	<b>DIN SPEC 10534-2019</b>
<b>type</b>	Residential dishwasher	Residential dishwasher	Residential dishwasher	Commercial dishwashers
<b>cycle</b>	sanitization cycle	sanitization cycle	Eco programme	Depending on machine type
<b>detergent</b>	Market detergent (at least 25% market share in past calendar year)	NO	IEC reference detergent D IEC rinse aid III	according to requirements (load, soil, special wares)
<b>cleaning performance</b>	Dishes must be visibly clean of soil and detergent in at least one of two trials.	rated	rated	visibly clean
<b>drying performance</b>	Not tested	rated	rated	externally dry, remaining droplets on supporting points and residual moisture in interior of hollow articles tolerated
<b>energy</b>	consumption not measured	-	consumption measured	-
<b>cycle duration</b>	not recorded	-	recorded	90 s single-tank 2 min multi-tank

	NSF/ANSI 184-2019	QB/T 1520-2013	IEC 60436-2015	DIN SPEC 10534-2019
<b>load</b>	Plates (filled lower rack) Glasses (filled upper rack) Forks (twice the amount of dishes)	Full load according to manufacturer's instructions	Tableware according to rated capacity including serving spoon, platter, pots and melamine bowls and plates	depending on machine type
<b>minimum temperature</b>	62 °C for sanitization in cleaning; 66 °C in rinsing	Not defined	not defined	40 – 50 °C pre-wash tank 60 – 65 °C wash tank
<b>soil</b>	Cultured buttermilk with 1% milk-fat content	25 mL pumpkin juice 10 g wheat flour 100 mL distilled water	dried-in <u>milk</u> with 1.5% to 2% fat content (10 mL per glass) dried-in <u>tea</u> in mugs, cups and saucers <u>minced meat</u> (mixed with whole egg) on platter, glass bowl and oven pot <u>egg yolk</u> on dessert plates, dinner plates and forks <u>porridge</u> on soup plates, dessert bowls and soup spoons <u>spinach</u> on dessert plates and pot (margarine mixture) <u>margarine</u> on melamine bowls	Test soils to embed bacteria BAMS on stainless steel biomonitors Reconstituted skimmed milk for glasses

	<b>NSF/ANSI 184-2019</b>	<b>QB/T 1520-2013</b>	<b>IEC 60436-2015</b>	<b>DIN SPEC 10534-2019</b>
<b>heat measurement</b>	3600 heat equivalent units needed to be sanitizing  (addition of values for period with continuous temperatures above 62 °C)		-	temperatures are monitored
<b>rinsing cycle temperature</b>	sanitizing rinse temperature must be $\geq 66$ °C		not defined	80 – 85 °C fresh water rinse
<b>microbial tests</b>	Not tested; sanitizing when HUEs are reached	% reduction calculated	none	goods tested by contact plates/swabs, detergent solution and reduction on stainless steel biomonitors
<b>microorganism in test (and biosafety-level)</b>	none	<i>E. coli</i> CGMCC 1.90 (2)  <i>Staph. aureus</i> CGMCC 1.89 (2)	none	<i>Ent. faecium</i> DSM 2146 (2) on stainless steel biomonitors embedded in BAMS

	NSF/ANSI 184-2019	QB/T 1520-2013	IEC 60436-2015	DIN SPEC 10534-2019
<b>microbiological requirements</b>	none specified, but 3600 HUE should result in microbial reduction of at least 5 logarithmic steps	reduction of the microbial load $\geq 99.9\%$ (3 logarithmic steps)	none	<u>general items</u> $< 5 \text{ cfu} \cdot 10 \text{ cm}^{-2}$  <u>transport boxes</u> critical food $< 50 \text{ cfu} \cdot 10 \text{ cm}^{-2}$ fungi $< 2 \text{ cfu} \cdot 10 \text{ cm}^{-2}$ very critical food $< 10 \text{ cfu} \cdot 10 \text{ cm}^{-2}$ no <i>Enterobacteriaceae</i>  <u>glasses</u> 90% log-reduction $\geq 5$ , rest $\geq 4$  <u>stainless steel biomonitors</u> in cutlery tray 7/8 log- reduction $\geq 5$ , rest $\geq 4$ transport trays or plates 90% log- reduction $\geq 5$ , rest $\geq 4$ on test rack log-reduction $\geq 5$  <u>detergent solution</u> reference value $\leq 200 \text{ cfu} \cdot \text{mL}^{-1}$ critical value: $500 \text{ cfu} \cdot \text{mL}^{-1}$



## 2. Objectives

Automatic household dishwashers that are sold in the EU must have an energy label showing they comply with the eco-design requirements. Those appliances are rated based on their energy and water consumption, capacity and programme time. The rating has changed over the years, but from 1<sup>st</sup> March 2021, the ratings are revised and will show an energy efficiency scaling from A (most efficient) to G (least efficient). By this date, ratings as A++ as handled presently, will be replaced. (Commission Delegated Regulation (EU), 2010, 2019; “Dishwashers | European Commission,” 2020) The different efficiency classes and their calculations are shown in Table 3 and an example comparing the current and future resulting energy efficiency class is given in Table 4.

The stricter regulations have led to an ongoing development towards lower cleaning temperatures, as most energy is used for heating up water. There are indications that lower cleaning temperatures may lead to higher microbial counts in the appliances (Brands *et al.*, 2016b; Brands and Bockmühl, 2015), but currently, no testing methods to evaluate the hygienic performance of household dishwashers are available.

Additionally, the available methods for commercial dishwashers use microorganisms of biosafety-level 2 that require specially equipped laboratories with an allowance to work with these organisms.

This thesis presents a method to systematically evaluate the antimicrobial performance of single dishwashing cycles, and the influence of the cycle parameters temperature, duration, chemistry (detergent) and at the same time investigates the possibility to replace the established biosafety-level 2 organism by a biosafety-level 1 microorganism to enable a wider group of (microbiological) laboratories to be allowed to work with this method and thereby facilitating the understanding of changed cleaning parameters. This facilitates the identification of appropriate measures to prevent possible future infections via dishwasher-cleaned goods in households with special needs, for example households with immunocompromised, old, young or pregnant members.

**Table 3: Information given on the energy label and the corresponding calculations.**

Before March 2021		After March 2021	
Energy efficiency classes (based on energy efficiency index EEI)			
A+++	$EEI < 50$	A (most efficient)	$EEI < 32$
A++	$50 \leq EEI < 56$	B	$32 \leq EEI < 38$
A+	$56 \leq EEI < 63$	C	$38 \leq EEI < 44$
A	$63 \leq EEI < 71$	D	$44 \leq EEI < 50$
B	$71 \leq EEI < 80$	E	$50 \leq EEI < 56$
C	$80 \leq EEI < 90$	F	$56 \leq EEI < 62$
D	$EEI \geq 90$	G (least efficient)	$EEI \geq 62$
Calculation of EEI			
$EEI = \frac{AE_c}{SAE_c} \times 100$		$EEI = \frac{EPEC}{SPEC} \times 100$	
<p><math>AE_c</math> = annual energy consumption of the household dishwasher in kWh/year rounded to two decimal places</p> <p><math>SAE_c</math> = standard annual energy consumption of the household dishwasher based on number of place settings (<math>ps</math>) and width</p> <p><math>ps \geq 10</math> and width &gt; 50 cm</p> $SAE_c = 7.0 \times ps + 378$ <p><math>ps \leq 9</math> or <math>9 &lt; ps \leq 11</math> and width <math>\leq 50</math> cm:</p> $SAE_c = 25.2 \times ps + 126$		<p><math>EPEC</math>: measured eco programme energy consumption in kWh · cycle<sup>-1</sup> (rounded to three decimal places)</p> <p><math>SPEC</math>: calculated standard programme energy consumption in kWh · cycle<sup>-1</sup> (rounded to three decimal places) depending on place settings (<math>ps</math>)</p> <p><math>ps \geq 10</math> and width &gt; 50 cm</p> $SPEC = 0.025 \times ps + 1.350$ <p><math>ps \leq 9</math> or width <math>\leq 50</math> cm:</p> $SPEC = 0.090 \times ps + 0.450$	

Annual energy consumption $AE_C$	Eco programme energy consumption ( $EPEC$ )
$AE_C = Et \times 280 + \frac{P_0 \times \frac{525600 - (T_t \times 280)}{2} + P_1 \times \frac{525600 - (T_t \times 280)}{2}}{60 \times 1000}$ <p><math>E_t</math> = energy consumption for the standard cycle, in kWh and rounded to three decimal places;</p> <p><math>P_l</math> = power in ‘left-on mode’ for the standard cleaning cycle, in W and rounded to two decimal places;</p> <p><math>P_0</math> = power in ‘off-mode’ for the standard cleaning cycle, in W and rounded to two decimal places;</p> <p><math>T_t</math> = programme time for the standard cleaning cycle, in minutes and rounded to the nearest minute;</p> <p>280 = total number of standard cleaning cycles per year</p> <p>When the household dishwasher is equipped with a power management system, with the household dishwasher reverting automatically to ‘off-mode’ after the end of the programme, <math>AE_C</math> is calculated taking into consideration the effective duration of ‘left-on mode’, according to the following formula:</p> $AE_C = Et \times 280 + \frac{(P_1 \times T_1 \times 280) + P_0 \times \frac{525600 - (T_t \times 280)}{2} + P_1 \times \frac{525600 - (T_t \times 280)}{2}}{60 \times 1000}$ <p><math>T_1</math> = measured time in ‘left-on mode’ for the standard cleaning cycle, in minutes and rounded to the nearest minute;</p> <p>280 = total number of standard cleaning cycles per year</p>	<p>Given in kWh per 100 cycles rounded to the nearest integer</p>

<b>Drying efficiency classes (based in drying efficiency index <math>I_D</math>)</b>	
A (most efficient)	$I_D > 1.08$
B	$1.08 \geq I_D > 0.86$
C	$0.86 \geq I_D > 0.69$
D E	$0.69 \geq I_D > 0.55$
F	$0.55 \geq I_D > 0.44$
G (least efficient)	$0.44 \geq I_D > 0.33$ $0.33 \geq I_D$
<b>Calculation of <math>I_D</math></b>	
$I_D = e^{\ln I_D}$ $\ln I_D = \frac{1}{n} \times \sum_{i=1}^n \ln\left(\frac{D_{t,i}}{D_{R,i}}\right)$ <p><math>D_{T,i}</math> = drying efficiency of the household dishwasher under test for one test cycle (<math>i</math>)</p> <p><math>D_{R,i}</math> = drying efficiency of the reference dishwasher for one test cycle (<math>i</math>)</p> <p><math>n</math> = number of test cycles, <math>n \geq 5</math></p> <p><math>D</math> = drying efficiency: average of the wet score of each load item after completion of a standard cleaning cycle, calculated based on water traces (<math>W_T</math>) or wet streak (<math>W_S</math>)</p>	

number of water traces ( $W_T$ ) or wet streak ( $W_S$ )	total wet area ( $A_w$ ) in mm <sup>2</sup>	Wet score
$W_T = 0$ and $W_S = 0$	-	2 (most efficient)
$1 < W_T \leq 2$ or $W_S = 1$	$A_w < 50$	1
$2 < W_T$ or $W_S = 2$ or $W_S = 1$ and $W_T = 1$	$A_w > 50$	0 (least efficient)
		<b>Duration of the eco programme</b>
		given in h:min rounded to the nearest minute
<b>Annual water consumption (<math>AW_C</math>)</b>		<b>Eco programme water consumption (<math>EPWC</math>)</b>
$AW_C = W_i \times 280$ (in litres and rounded up to the nearest integer)		Given in L per cycle, rounded to one decimal place
$W_i$ = water consumption for the standard cleaning cycle, in litres and rounded to one decimal place		
<b>Rated capacity</b>		<b>Rated capacity for the eco programme</b>
number of place settings ( $ps$ ) for the standard cleaning cycle		Given in standard place settings ( $ps$ )
<b>Noise emissions</b>		<b>Airborne acoustic noise emissions and emission class</b>
airborne acoustical noise emissions expressed in dB(A) re 1 pW rounded to the nearest integer		expressed in dB(A) with respect to 1 pW and rounded to the nearest integer
		A $n < 39$
		B $39 \leq n < 45$
		C $45 \leq n < 51$
		D $51 \leq n$

**Table 4: Exemplary calculations of the energy label for a device available on the market for the old and new energy labelling**

Before March 2021	After March 2021
<b>Energy efficiency class</b>	
A++	E
<b>Calculation</b>	
$EEI = \frac{AE_c}{SAE_c} \times 100 = \frac{262 \text{ kWh} \cdot \text{year}^{-1}}{469 \text{ kWh} \cdot \text{year}^{-1}} \times 100$ <p style="text-align: center;"><b><math>EEI = 55.86</math></b></p> $SAE_c = 7.0 \times ps + 378$ $SAE_c = 7.0 \times 13 + 378$ $SAE_c = 469 \text{ kWh} \cdot \text{year}^{-1}$ $AE_c = Et \times 280 + \frac{(P_1 \times T_1 \times 280) + P_0 \times \frac{525600 - (T_t \times 280)}{2} + P_1 \times \frac{525600 - (T_t \times 280)}{2}}{60 \times 1000}$ $AE_c = 0.93 \times 280 + \frac{(0.93 \times 30 \times 280) + 0.22 \times \frac{525600 - (225 \times 280)}{2} + 0.39 \times \frac{525600 - (225 \times 280)}{2}}{60 \times 1000}$ <p style="text-align: center;"><b><math>AE_c = 262.88</math></b></p>	$EEI = \frac{EPEC}{SPEC} \times 100 = \frac{0.930 \text{ kWh} \cdot \text{cycle}^{-1}}{1.675 \text{ kWh} \cdot \text{cycle}^{-1}} \times 100$ <p style="text-align: center;"><b><math>EEI = 55.52</math></b></p> $SPEC = 0.025 \times ps + 1.350$ $SPEC = 0.025 \times 13 + 1.350$ $SPEC = 1.675 \text{ kWh} \cdot \text{cycle}^{-1}$ $EPEC = 0.930 \text{ kWh} \cdot \text{cycle}^{-1}$
<b>Annual water consumption (<math>AW_C</math>)</b>	<b>Eco programme water consumption (<math>EPWC</math>)</b>
$AW_C = W_t \times 280 = 10.5 \text{ L} \times 280 = 2940 \text{ L}$	$10.5 \text{ L} \cdot \text{cycle}^{-1}$

### 3. Materials and methods

The development of a method to evaluate factors influencing the microbial reduction in domestic dishwashers was partly based on existing standards. As can be seen in Table 2, the current standard for domestic dishwashers only give criteria for a classification as sanitizing equipment. As sanitization is usually not necessary in the residential environment unless there are special needs, *e.g.* immunocompromised household members, the new method aims at the objective evaluation of the hygienic performance of certain cleaning cycles, appliances or observation of the effect of additional measures (hygiene programmes etc.).

To achieve this, a differentiation between different cycle parameters has to be achieved and at the same time, the currently used test organisms of biosafety-level (BSL) 2 (Ausschuss für Biologische Arbeitsstoffe, 2018) should be replaced by organisms of BSL 1 to extend the number of laboratories that can run the tests.

Artificially contaminated biomonitors are cleaned together with the standard load in a dishwasher set to different cleaning temperatures (45 °C to 75 °C) and cleaned in cycles with different main cleaning durations (5 min to 90 min) and different detergents including cycles without detergent.

In these cleaning cycles, the established BSL 2 strain is used alongside with a BSL1 strain to directly compare the ability of the new candidate strain to the established strain.

#### 3.1. Test strains

Candidate test strains have been selected from literature including several strains that are either relevant as foodborne pathogens such as *Salmonella* spp. or *Campylobacter* spp., strains that have been isolated from soiled dishes (Berger *et al.*, 2015; Zalar *et al.*, 2011) or dishwashers (Brands *et al.*, 2016b) as well as strains that were previously used in other standards or have recently been used in comparable setups (Berger *et al.*, 2015; Brands and Bockmühl, 2015; Kerschgens *et al.*, 2016; Klapper *et al.*, 2018; Zinn *et al.*, 2018). In this, the focus was on finding strains of BSL 1 according to the German Technical Rules for Biological Materials (Ausschuss für Biologische Arbeitsstoffe, 2018).

The candidate strains have first been tested in suspension tests to identify candidates that are heat-resistant to withstand the temperatures in dishwashers and that are resistant to the detergent used (Amberg, 2018; IEC 53A WG3, 2019).

The most promising strain in terms of heat resistance and detergent resistance was *M. luteus* DSM 1790, a strain different from the one used in tests previously performed at the University of Bonn (Berger *et al.*, 2015).

For that reason, in initial tests in the dishwasher, three different strains of *M. luteus* (DSM 1790, DSM 20030<sup>T</sup> and DSM 28269) have been used.

Table 5 shows an overview of the candidate test strains with their according collection numbers, the corresponding BSL and the supplier along with the tests they have been used for. Additionally, the tests they are used in are given together with some possible food sources for the respective organisms.

**Table 5: List of the microorganisms that have been used in the tests (ST = suspension tests, HDW = hand dishwashing tests, TGT = tergotometer tests, DW = dishwasher tests) with their respective ATCC and DSM numbers. Microorganisms marked with a superscript T are type strain microorganisms. Possible food sources and the respective references are given in the last column.**

\* suspension tests (ST) have been carried out by Swissatest (Amberg, 2018; IEC 53A WG3, 2019).

strain	DSM	BSL	Gram-status	supplier	used in	source/ reference
<i>Bacillus subtilis</i>	10 <sup>T</sup>	1	gr+	DSMZ	ST*	egg products (Corry, 2007b)
<i>Campylobacter jejuni</i> subsp. <i>jejuni</i>	4688 <sup>T</sup>	2	gr-	DSMZ	ST* DW	Fish, meat, poultry (Bartelt <i>et al.</i> , 2008; Giaouris <i>et al.</i> , 2013; Lubner and Bartelt, 2007; Scherer <i>et al.</i> , 2006)
<i>Candida albicans</i>	1386	2	-	DSMZ	ST* DW	Poultry, meat (International Commission on Microbiological Specifications for Foods (ICMSF), 2019c)
<i>Enterococcus faecium</i>	2146	2	gr+	DSMZ	ST*	used in standards



					TGT DW	(Deutsches Institut für Normung e. V., 2019)
strain	DSM	BSL	Gram-status	supplier	used in	source/ reference
<i>Escherichia coli</i>	682	2	gr-	DSMZ	ST*	milk, fish, meat, poultry (Bartelt <i>et al.</i> , 2008; International Commission on Microbiological Specifications for Foods (ICMSF), 2019c; Lindblad <i>et al.</i> , 2006; Otte-Südi, 2006a)
<i>Micrococcus luteus</i>	28269	1	gr+	University of Bonn	DW	Isolated from used dishes (Berger <i>et al.</i> , 2015)
<i>Micrococcus luteus</i>	1790	1	gr+	DSMZ	ST* HDW TGT DW	Fish (products), meat (products), egg (products), poultry (Corry, 2007a, 2007b; International Commission on Microbiological Specifications for Foods (ICMSF), 2019b)
<i>Micrococcus luteus</i>	20030 <sup>T</sup>	1	gr+	DSMZ	DW	
<i>Pseudomonas aeruginosa</i>	939	2	gr-	DSMZ	ST* DW	Salads, fish, meat, poultry (García-Gimeno and Zurera-Cosano, 1997; International Commission on Microbiological Specifications for Foods (ICMSF), 2019b; Lack <i>et al.</i> , 1995)
<i>Salmonella enterica</i> subsp. <i>enterica</i> Serovar Typhimurium	5569	2	gr-	DSMZ	ST*	dairy products, fish, salads, meat, egg, poultry (International Commission on Microbiological Specifications for Foods (ICMSF), 2019a; Jay <i>et al.</i> , 2005; Lack <i>et al.</i> , 1995; Lindblad <i>et al.</i> , 2007)

strain	DSM	BSL	Gram-status	supplier	used in	source/ reference
<i>Staphylococcus aureus</i> subsp. <i>aureus</i>	799	2	gr+	DSMZ	ST* TGT	dairy products, fish, meat, egg products, poultry (Frank, 2007; Griffiths, 2000; International Commission on Microbiological Specifications for Foods (ICMSF), 2019a, 2019d, 2019b, 2019c)

### 3.1.1. *Micrococcus luteus*

*Micrococcus luteus* (*M. luteus*) is a gram-positive bacterium from the phylum Actinobacteria. This coccus is non-motile, obligatory aerobic, forms tetrads, is pigmented, catalase-positive and tolerant to high salt concentrations and drought. (Baird-Parker, 1965; Gayral *et al.*, 1997; Madigan *et al.*, 2013; Steiner *et al.*, 2002) Members of the genus *Micrococcus* have been detected in dishwashers (Zupančič *et al.*, 2019) and in particular *M. luteus* from soiled dishes (Berger *et al.*, 2015). *M. luteus* is heat resistant (Klapper *et al.*, 2018).

Strain DSM 1790 which has been deposited as *Micrococcus flavus* Trevisan by AR Stanley from the Commercial Solvents Corporation has been isolated from air. It is used as quality control strain, in food testing, the assay of bacitracin and in Pharmaceutical and Personal Care. (ATCC, 2020; Darker *et al.*, 1948)

Biochemical identification using the VITEK<sup>®</sup> 2 compact system by Biomérieux with corresponding Vitek<sup>®</sup> 2 GP identification cards for gram positive bacteria resulted in the identification of the used strain as member of the *Micrococcus luteus*/*Micrococcus lylae* cluster. Both of them give identical patterns, so further separation is not possible with this method (bioMérieux, 2016).

Strain DSM 28269 was isolated from soiled dishes and has previously been used in tests to compared hand dishwashing and automated dishwashing (Berger *et al.*, 2015).

### 3.1.2. *Enterococcus faecium*

*Enterococcus faecium* (*Ent. faecium*) is a Gram-positive bacterium from the phylum Firmicutes. This coccus is non-motile, facultative anaerobic, found as single cell, pairs or short chains, is catalase- and oxidase-negative and tolerant to high salt concentrations. *Ent. faecium* is tolerant to heat and chemicals. (Bradley and Fraise, 1996; Laport *et al.*, 2003; Madigan *et al.*, 2013; Martinez *et al.*, 2003; Renner and Peters, 1999) The heat resistance has been determined previously, stating that *Ent. faecium* DSM 2146 was able to survive for 10 min at 70 °C when an initial count of  $1 \times 10^8$  cfu · mL<sup>-1</sup> were used (Ståhl Wernersson *et al.*, 2004b).

*Ent. faecium* has been utilized in different setups to evaluate the microbial reduction in dishwashers in hospitals (Ebner *et al.*, 2000; Francis and Newsom, 1987) and is used in standards to determine the hygienic performance of commercial dishwashers (Deutsches Institut für Normung e. V., 1999, 2006a, 2013, 2019) and is used here to compare the results of *M. luteus* DSM 1790 with this established test-organism.

### 3.1.3. *Staphylococcus aureus*

*Staphylococcus aureus* subsp. *aureus* (*S. aureus*) is a Gram-positive bacterium from the phylum Firmicutes. The diameter of *S. aureus* is 0.5 – 1.5 µm, it is facultative aerobic, non-motile, normally forms clusters of cells that look like grapes (hence the name, derived from the Greek word for grape), is pigmented and highly resistant against drought and high salt concentrations. (Cypionka, 2010; Fritsche, 2016; Leung, 2014; Madigan *et al.*, 2013)

*S. aureus* was included in the detergent effect tests in the tergotometer as it is used as one of the reference strains in standards for disinfection (Deutsches Institut für Normung e. V., 2006b, 2006c) and has been used in a comparable study in household washing machines (Honisch *et al.*, 2014a).

## 3.2. Cultivation of Microorganisms

The microorganisms were cultivated in surface culture on appropriate growth media (for details see Table A1). An inoculation loop was filled with material from the revived stock culture and

the material was spread on the agar plate. The inoculated plates were incubated at the indicated temperatures for the indicated time periods (see Table A1). From this first subculture, second and third subcultures were prepared by transferring material to fresh agar plates as described above. The third subculture was used to prepare the biomonitors.

### **3.3. Heat resistance testing**

A heat resistance test as described in DIN SPEC 10534 (Deutsches Institut für Normung e. V., 2019) has been performed to test the heat resistance of the different strains of *M. luteus* and for *Ent. faecium* DSM 2146. For each condition to be tested later, three biomonitors were prepared (see 3.6) on the day before the test. The prepared biomonitors were stored in single tubes at 5 °C prior to the test.

Test tubes with 20 mL tryptic soy broth were heated to different temperatures that were later applied in the dishwasher tests. The prepared biomonitors were placed into the broth-containing tubes and kept at the set temperature for durations of 15, 45 and 90 min. At the end of this period, the tube was cooled down to room temperature under running water and then incubated at the necessary temperature for 48 h, before the growth in the test tubes was evaluated.

## **3.4. Soil matrix**

### **3.4.1 Choice of the soil matrix**

At the beginning of the experiments, different soil matrices found in literature have been tested. One-step approaches as well as two-step soiling setups have been investigated. All tests were performed with a minimum of 3 soiled items or biomonitors. An overview of these matrices and the soiling procedures used is given in Table 6.

**Table 6 Overview of the different soil matrices tested. Their composition and the soiling procedure is given.**

<b>Matrix test</b>	<b>matrix composition</b>	<b>Soiling procedure</b>
1	0.6% bovine serum albumin 3% corn starch	5 mL soil are spread on the surfaces and dried for 90 min at 70°C, inoculation with microorganisms after cooling to room temperature
2	1% mucin 0.6% bovine serum albumin 3% corn starch	Matrix prepared according to CEN ISO/TS 15883-5:2005  Mixture of microorganism and soil matrix is applied to surface, dried for 2h at room temperature
3	custard (Ruf, “Unser Pudding” Vanille), 37 g 500 mL milk (1.5% fat, U.H.T.) 40 g sucrose	follow instructions of producer to cook cool to room temperature and mix 100 g with 5 mL of liquid culture  10 g spread on a plate  dry for 2 h or 18 h at room temperature
4	Porridge according to IEC 60436 mix 50 g oat flakes, 750 mL cold water and 250 mL milk (1.5% fat, UHT), bring to the boil and boil for 10 min	cool to room temperature after preparation, store in refrigerator  mix 150 g with 5 mL liquid culture  10 g spread on a plate  dry for 2 h or 18 h at room temperature
5	mashed potatoes (convenience product prepared with 500 mL water and 200 mL milk (1.5% fat, U.H.T.)	Mix 100 g mashed potatoes cooled to room temperature with 5 mL liquid culture  10 g spread on a plate  dry 24 h at room temperature

<b>Matrix test</b>	<b>matrix composition</b>	<b>Soiling procedure</b>
6	Rice pudding (250 g rice cooked in 1 L milk (1.5% fat, U.H.T.))	Mix 100 g rice pudding cooled to room temperature with 5 mL liquid culture 10 g spread on a plate dry 24 h at room temperature
7	condensed milk	5 mL condensed milk are added to a plate and dried at room temperature for 90 min the pelleted microorganism is mixed with 5 mL condensed milk and 1 mL is spread evenly on the plate
8	1% mucin 0.6% bovine serum albumin 3% corn starch	5 mL are spread on a plate and dried at 80 °C for 90 min The pellet of a liquid culture is mixed with 15 mL BAMS and 1 mL is spread on one of the prepared plates and dried for 2h at 22 °C and 55% relative humidity (r.h.)
9	1% mucin 0.6% bovine serum albumin 3% corn starch 10% milk powder (skimmed milk)	The pellet of a liquid culture is mixed with 5 mL BAMS and 0.1 mL is spread on one of the biomonitors and dried for 4h at 22 °C and 55% r.h.; biomonitors are either frozen at -18°C until use or refrigerated at 4 °C
10	1% mucin 0.6% bovine serum albumin 3% corn starch	The pellet of a liquid culture is mixed with 5 mL BAMS and 0.1 mL is spread on one of the biomonitors and dried for 4h at 22 °C and 60% r.h.; biomonitors are either frozen at -18°C until use or refrigerated at 4 °C

Matrix test	matrix composition	Soiling procedure
11	1% mucin 0.6% bovine serum albumin 3% rice starch	The pellet of a liquid culture is mixed with 5 mL BAMS-R and 0.1 mL is spread on one of the biomonitors and dried for 4h at 22 °C and 60% r.h.; biomonitors are either frozen at -18°C until use or refrigerated at 4 °C
12	egg yolk CaCl <sub>2</sub> (6%; 8%; 10%;12%; 24% )	Mix egg yolk with CaCl <sub>2</sub> solution and pellet of liquid culture  Spread 100 µL on each biomonitor  Dry for 4h or 18h at 22 °C and 60% r.h.
13	1% mucin 0.6% bovine serum albumin 3% corn starch 10% egg yolk	Mix pellet of liquid culture with soil matrix  Spread 100 µL on each biomonitor  Dry for 4h at 22 °C and 60% r.h.
14	1% mucin 0.6% bovine serum albumin 3% corn starch	Matrix prepared according to CEN ISO/TS 15883-5:2005 (also see 3.4.1)  Mixture of microorganism and soil matrix is applied to surface, dried for 4 h at 22 °C and 70% r.h.

### 3.4.1 Preparation of the soil matrix BAMS

The cultivated microorganisms were embedded in a soil matrix as described in 3.5. The soil matrix contained 0.6% bovine serum albumin (BSA), 1% mucin and 3% corn starch as described in DIN 10512 (Deutsches Institut für Normung e. V., 2008) and DIN SPEC 10534 (Deutsches Institut für Normung e. V., 2019), which will be referred to as BAMS. According to DIN ISO/TS 15883-5:2006 (Deutsches Institut für Normung e. V., 2005), for 30 mL BAMS, 0.3 g mucin were dissolved in 20 mL sterile water and heated to 50 – 60 °C under continuous stirring. To this, 0.18 g BSA was added. The solution was cooled to room temperature under continuous stirring. At the same time, 8 mL sterile water was heated to the boiling point. Corn

starch (0.9 g) was dissolved in 2 mL sterile water and mixed with the boiling water. The solution was heated and stirred until it became visibly more viscous. The heat was then reduced and the solution was cooled to room temperature under continuous stirring. When both solutions had reached room temperature, they were mixed for a total of 30 mL BAMS.

### **3.5. Preparation of the inoculation solution**

Three TSA plates containing the third bacterial subculture of a single strain of bacteria were rinsed each with 10 mL sterile 0.9% NaCl-solution. The suspension was centrifuged for 5 min at 4696 g. The supernatant was discarded and the pellet was resuspended in 10 mL 0.9% NaCl. After repeated centrifugation at 4696 g, the supernatant was discarded and the pellet was resuspended in 10 mL BAMS.

### **3.6. Preparation of biomonitors**

Stainless steel biomonitors according to DIN EN 10088-3 (Deutsches Institut für Normung e. V., 2014) as described in DIN 10512 (Deutsches Institut für Normung e. V., 2008) and DIN SPEC 10534 (Deutsches Institut für Normung e. V., 2019) and shown in Figure 3 were used for the dishwasher tests. The biomonitors were cleaned in an ultrasound bath, dried and sterilized in an autoclave. The middle section was inoculated with 100 µL inoculation solution on the grained side reaching an initial count of  $10^9$  cfu per bimonitor. The solution was spread evenly on the surface using a sterile plastic inoculation. The biomonitors were dried at 22 °C and 70% relative humidity for 4 h in a constant climate chamber. After drying, the biomonitors were individually stored in closed test tubes and kept at 5 °C until use.



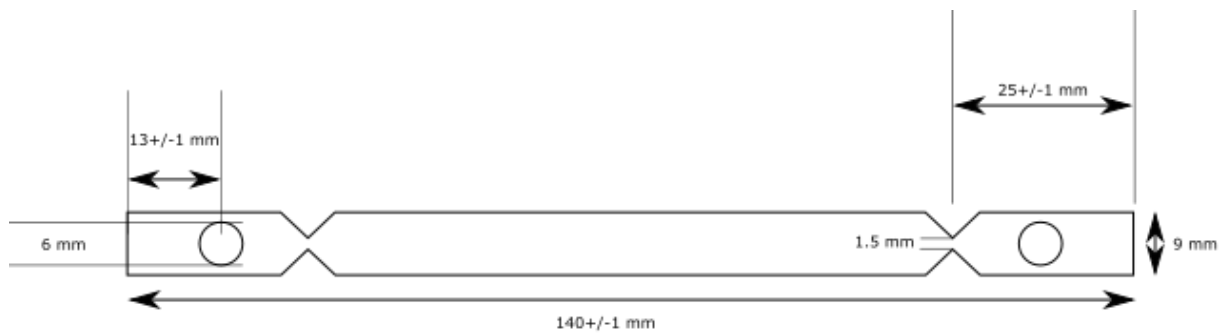

**Figure 3: Biomonitor as used in the dishwasher tests. The biomonitor is made of austenitic steel and has unilateral longitudinal grain with granulation 80 on the front side. (own representation)**

For the tests in the tergotometer or dishwashing by hand, a different kind of biomonitor was used due to the limited space in the tergotometer test vessels. These biomonitor are described in DIN EN 13697 (Deutsches Institut für Normung e. V., 2012). These biomonitor are round, with a diameter of 20 mm and made of austenitic steel (see Figure 4). They do not have any granulation. These biomonitor are contaminated as described before and kept in closed petri dishes after preparation.

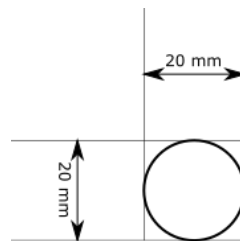

**Figure 4: Biomonitor used for tests in the tergotometer and in hand dishwashing tests. (own representation)**

### 3.7. Dishwashing procedures

The biomonitor are cleaned in different dishwashing procedures. The details for the hand dishwashing process, the testing in the tergotometer and the tests in the automated dishwasher are described in detail in the following sections. For the different methods, different kinds of detergents were used. For hand dishwashing, a liquid market dishwashing detergent was used, while for the tergotometer tests and the tests in the automated dishwasher reference detergent from DIN SPEC 10534 was used. To be able to separate the effect of the activated oxygen

bleach, the reference detergent was modified. In this modified version, the bleach components including the bleach activators were removed. The compositions of the used detergents are given in Appendix: Detergent compositions.

### **3.7.1. Dishwashing by hand**

For hand dishwashing procedures, the temperature of the washing water was set to either 40 °C or 50 °C. To this washing water, either no detergent was added, or liquid dishwashing detergent that is customary in the market was dosed according to the manufacturer's instructions, resulting in a concentration of 1 mL·L<sup>-1</sup> washing-up water. The biomonitors were soaked in the washing-up water for either 5 min or 10 min. Depending on the chosen conditions, either no, 10 or 20 scrubbing cycles at 35 cpm using a pre-wetted cloth fastened to the wet abrasion scrub tester REF 903/PG (Sheen Instruments, Cambridge, UK) were applied using 200 g of contact pressure weight. The cloth moves over the biomonitor with constant pressure once from left to right and back to the left in each cycle. After the treatment, the biomonitors were rinsed with 50 mL of water. The biomonitors were then extracted as described in 3.8..

### **3.7.2. Simulation of dishwashing in the Tergotometer**

The tergotometer is a device in which eight vessels can be used simultaneously to test detergent formulations in a small scale. The vessels are made of either glass or stainless steel and are immersed into a water bath with regulated temperature. In the vessels, different detergents can be tested simultaneously under the same temperature conditions so that the differences in the results are linked to the differences in the detergent used. Biomonitors (in this case round stainless steel coupons due to the limited space available) are situated on the dishwasher slide accessory and submerged into the detergent solution. The accessory is fastened to an agitator with which the rotation speed of the accessory can be controlled to mimic the mechanical influence.

The biomonitors were evenly distributed on the bottom surface of the dishwasher slide accessory of the tergotometer with the contaminated side showing. The accessory with the biomonitors was carefully submerged into the water set to temperatures ranging from 45 °C to

65 °C and containing different detergents (either no detergent, 3.64 g·L<sup>-1</sup> bleach-free powder detergent or 4 g·L<sup>-1</sup> activated oxygen-bleach containing detergent). The accessory was set to rotate at 50 rpm for either 5 min, 10 min or 15 min. At the end of the cleaning cycle, the biomonitors were carefully removed from the accessory with sterile pincers and extracted as described in 3.8..

From each vessel, a water sample was taken and mixed with an equal amount of EL. This mixture was incubated at room temperature for 5 min to neutralize remaining detergent. A decimal dilution series in 0.9% sodium chloride (NaCl) solution was prepared as described in 3.8. After incubation the number of colonies detected in the vessel was calculated. This number allows to calculate the amount of bacteria that are removed from the biomonitor during the dishwashing process but not inactivated.

### **3.7.3. Automated dishwashing**

All tests were performed in an automated dishwasher Miele GSL-2 (Miele & Cie KG, Gütersloh), which was specially programmed for the tests by the manufacturer. All cycles contained a main cleaning phase followed by an intermediate and a final rinsing cycle.

Different experiments were performed with variations in the cleaning temperature and fixed rinsing temperature or fixed cleaning temperature and variations in the rinsing temperature. For details on the combinations of test microorganism, cleaning temperature, rinsing temperature and detergent used, see Table 7.

**Table 7: Overview of the test parameters in the domestic dishwasher- each test organism was tested with every detergent type, cleaning cycle duration, cleaning cycle temperature and rinsing cycle temperature given.**

laboratory	test organism	detergent	cleaning cycle duration	temperature	
				cleaning cycle	rinsing cycle
Rhine-Waal University of Applied Sciences	<i>Ent. faecium</i> DSM 2146	no detergent (ND)	5 min	45 °C	50 °C
		bleach free powder detergent (DT)	10 min	50 °C	
			15 min	55 °C	
	<i>M. luteus</i> DSM 1790	powder detergent containing activated oxygen bleach (AOB)	45 min	60 °C	
			90 min	65 °C	
				75 °C	
University of Bonn	<i>M. luteus</i> DSM 1790	powder detergent containing activated oxygen bleach (AOB)	15 min	45 °C	35 °C
	<i>M. luteus</i> DSM 20030 <sup>T</sup>			50 °C	50 °C
	<i>M. luteus</i> DSM 28269			70 °C	

To the dishwashing cycles with 12 place settings according to IEC 60436 (International Electrotechnical Commission, 2015), either no detergent (ND), 18.2 g of bleach-free powder detergent (DT) that was specially mixed for the tests and missing the bleach components or 20 g of activated oxygen bleach-containing detergent (AOB) was added. Rinse aid III and salt were dosed automatically by the appliance. The settings of the appliance were adjusted to the water hardness of 1.18 mmol·L<sup>-1</sup> ( $\cong$  6.64 °dH). For each dishwashing cycle, water usage was monitored and the temperature profile was recorded using temperature loggers TELID®311 two of which were situated in the cutlery drawer and the third one was situated in the sump of

the appliance. Additionally, 100 g of frozen ballast load according to IEC 60436 were added in a beaker situated on the left side of the upper rack.

The different phases of a dishwashing cycle are shown in Figure 5.

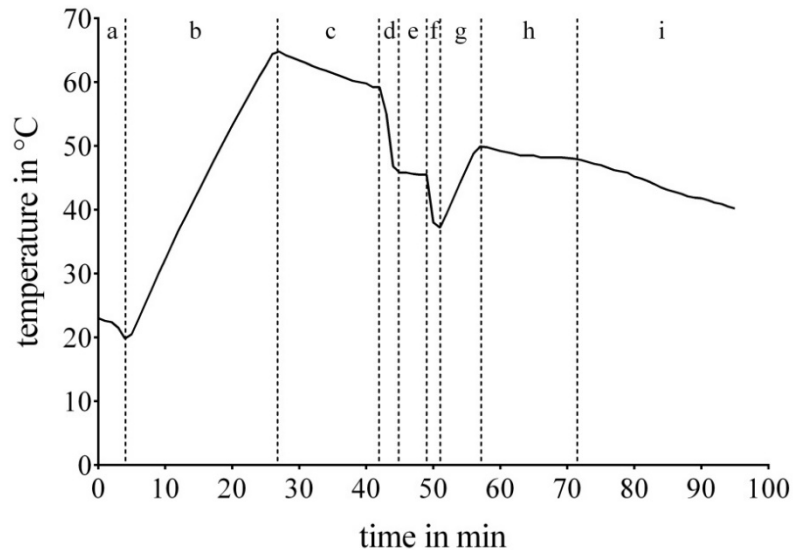

**Figure 5:** Typical temperature profile of a dishwashing cycle with a main cleaning cycle temperature of 65 °C and a final rinsing temperature of 50 °C is shown. The different phases are water inlet (a), heating phase (b), main cleaning cycle (c), water intake for first rinsing (d), first rinsing cycle (e), water intake for final rinsing (f), heating phase for final rinse (g), final rinsing cycle (h) and drying period (i).

The biomonitors were fastened to holders that are mounted on plates as described in DIN SPEC 10534 but with modified holders. The difference lies in the orientation of the biomonitors in relation to the surface of the plates. The orientation used here is rotated by 90° compared to the standard. This was done to orientate the bimonitor surface in the same orientation as the surface of the dinner plates. The biomonitors were fastened in a way that the contaminated side of the biomonitors was facing away from the plate (Figure 6).

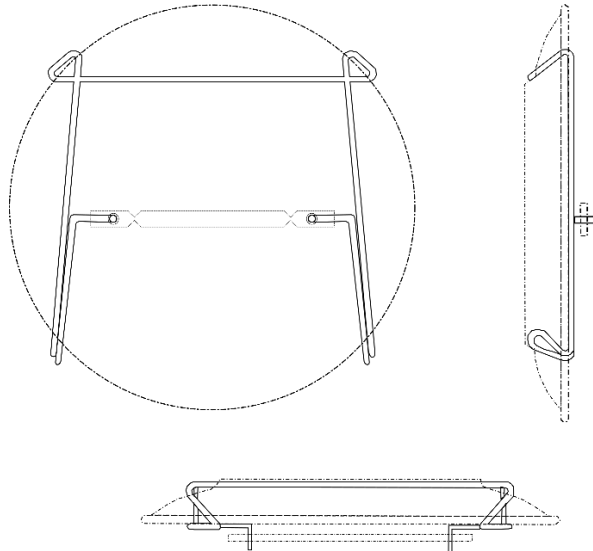

**Figure 6: Biomonitor fastened to the holder that is mounted to a dinner plate. The contaminated side of the biomonitor is facing away from the plate (own representation).**

In each dishwashing cycle, three biomonitors contaminated with a single bacterial strain were introduced. In the tests, biomonitors with *M. luteus* DSM 1790 and *Ent. faecium* DSM 2146 were tested in parallel, resulting in a total of six biomonitors per dishwashing cycle. The locations of the biomonitors in the dishwasher are shown in Figure 7. All parameter combinations were tested in three independent repeats.



**Figure 7: Localisation of the biomonitors in the lower basket of the dishwasher. On each side, three biomonitors with one bacterial strain are added (own representation).**

In tests to determine the influence of the final rinsing temperature in the microbial load, only biomonitors containing one strain of *M. luteus* each were cleaned in the dishwasher as the laboratory used at the University of Bonn is restricted to the use of microorganisms of BSL1.

### 3.8. Determination of the microbial load

The microbial load of the biomonitors was detected by surface culture after extraction in an extraction liquid (EL) consisting of 5 mL TSB containing 30 g·L<sup>-1</sup> polysorbate 80, 0.3 g·L<sup>-1</sup> lecithin, 1 g·L<sup>-1</sup> histidine and 5 g·L<sup>-1</sup> sodium thiosulfate to neutralize the effects of possible residues of the detergent. For the dishwasher biomonitors, extraction was performed in test tubes with screw caps as follows: the biomonitors were transferred to the test tubes containing 2 g glass beads with a diameter of 3 mm and 5 mL EL. The tubes were initially vortexed at the highest speed for 3 s and transferred to a tilt/roller-mixer set 80 rpm. After extraction at room temperature for 10 min, the tubes were again vortexed for 3 s before the biomonitors were removed from the tube with sterile pincers.

The extraction time, the speed of the tilt roller mixer, as well as the amount of glass beads and extraction liquid has been determined in pre-tests. In those pre-tests, speed settings between 20 rpm (minimum setting of the device) and 80 rpm (maximum setting of the device) have been tested in combination with different extraction durations between 5 min and 20 min, amounts of glass beads between 2 g and 4 g, variations in the sizes of the glass beads (between 1.5 mm and 4 mm) and with the initial orientation of the bimonitor with the contaminated side oriented to the top (facing away from the glass beads) or the bottom (facing the glass beads).

Each of the biomonitors from dishwashing by hand or tergotometer were transferred to one well of a 6-well plate containing 5 mL EL as described above and 3 g glass beads to cover the bottom of the well. The biomonitors are placed on top of the glass beads with the contaminated site directed to the glass beads and are extracted by shaking the plate on a digital rocking shaker set to 80 rpm. After 5 min of extraction, the 6-well plate is turned by 90° and the extraction is continued for another 5 min. After extraction, the biomonitors are removed with sterile pincers.

Different amounts of beads and different orientations of the biomonitors have been tested here in pre-tests.

From the EL of each extraction, separate decimal dilution series in 0.9% sodium chloride (NaCl) solution were prepared and 100  $\mu$ L of appropriate dilutions were inoculated onto TSA plates. After incubation for 48 h at 37 °C for *Ent. faecium* DSM 2146 or 30 °C for the different *M. luteus* strains, the number of colonies per plate was detected. From plates containing 10 to 300 colonies, the weighted averages were calculated. From these, the number of viable cells in the extraction liquid was calculated as shown in equation 1 (Bast, 2014).

$$c_w = (V \cdot 10^{-x})^{-1} \cdot \frac{\sum c_x + \sum c_{x+1}}{n_x + 0.1 n_{x+1}} \quad (1)$$

where

$c_w$  is the weighted mean of the viable count in 1 mL undiluted sample

$10^{-x}$  is the dilution factor of the lowest countable dilution

$V$  is the sample volume spread out per plate in mL

$\sum c_x$  is the sum of colonies on all plates of the lowest countable dilution

$\sum c_{x+1}$  is the sum of colonies on all plates of the next higher dilution

$n_x$  is the number of plates counted in the lowest countable dilution

$n_{x+1}$  is the number of plates counted in the next higher dilution

### 3.9. Calculation of the microbial reduction

The logarithmic reduction factor ( $LR$ ) is defined as the difference in the common logarithms of the number of viable cells per mL extraction liquid of untreated biomonitors and cleaned biomonitors as described in equation 2 (Deutsches Institut für Normung e. V., 2019)

$$LR = \log_{10} c_i - \log_{10} c_r \quad (2)$$

where

$LR$  is the logarithmic reduction factor

$c_i$  is the microbial load in the EL (in cfu·mL<sup>-1</sup>) of the biomonitor before dishwashing (initial microbial load)

$c_r$  is the microbial load in the EL (in cfu·mL<sup>-1</sup>) of the biomonitor after dishwashing (remaining microbial load)



The lower detection limit of the method is determined by the volume used for the surface culture. In most of the experiments, 100  $\mu\text{L}$  of the extraction liquid and its dilutions were used, resulting in a detection limit of 100  $\text{cfu} \cdot \text{mL}^{-1}$ . For some critical conditions, 250  $\mu\text{L}$  of the extraction liquid was used in the surface culture, resulting in a lower detection limit of 40  $\text{cfu} \cdot \text{mL}^{-1}$ .

In cases, when the remaining microbial load after the dishwashing procedure was below the detection limit,  $c_r$  was set to zero. Thus, in cases in which the remaining microbial load was under the lower detection limit,  $c_i$  equals  $LR$ . This is referred to as complete reduction of the microbial load hereafter.

To assess the change in the  $LR$  caused by a change of one of the parameters investigated, the term  $\Delta LR$  is defined as the difference between two  $LR$  values that are caused by a change of only one named parameter, e.g.  $\Delta LR_{temp}$  for a difference in the  $LR$  that is caused by a change in the temperature. All other parameters are unchanged in the compared tests. It is calculated according to equation 3.

$$\Delta LR = LR_2 - LR_1 \quad (3)$$

where

$\Delta LR$  is the difference between two logarithmic reduction factors

$LR_1$  is the logarithmic reduction factor observed with the parameter settings in a certain experiment

$LR_2$  is the logarithmic reduction factor observed with the parameter settings in a certain experiment, in which a single parameter was changed compared to the conditions which were used to receive  $LR_1$

In cases, when different batches of biomonitors with different initial counts were used the values were standardized. For this, the percent logarithmic reduction (% LR) of each condition was calculated. First, the logarithmic reduction was calculated as above. The results were then converted into percentage logarithmic reduction (% LR) and into the standardized LR (SLR) as in the following example:

parameter	batch 1	batch 2
<b>log<sub>10</sub> (initial count)</b>	7.5	9.5
<b>log<sub>10</sub> (remaining count)</b>	2.1	2.2
<b>LR</b>	5.4	7.3
<b>% LR</b>	72	76.84
<b>SLR</b>	6.84	7.3

% LR is calculated as follows:

$$\% LR = \left( \frac{LR}{\log_{10}(\text{initial count})} \right) * 100$$

SLR is calculated as follows:

$$SLR = \frac{\% LR}{100} \times \log_{10}(\text{highest initial count in batches})$$

The SLR is thus identical to the LR for the batch with the higher counts, but is different for the batch with the lower counts but at the same time makes comparisons possible between batches based on the measured reductions.

### 3.9.1. Statistical analysis

The results were submitted to Kruskal-Wallis tests to detect possible differences in the medians of the tested groups (Kruskal and Wallis, 1952) as most of the data were not normally distributed. In case one or more significant differences were found amongst the groups, Dunn's multiple comparisons test (Dunn, 1961) was performed to identify which of the groups differed from the rest. Two-way ANOVA was used to detect differences amongst the medians of the tested groups when the data followed Gaussian distribution. In these cases, either Šidák's multiple comparisons test (Šidák, 1967) or Tukey's multiple comparisons test (Tukey, 1949) was performed to identify the differences between the single groups. When all groups' means were compared, Tukey's test was used, if not all groups' means were compared, Šidák's multiple comparison test was performed.

### 3.9.2. Four-parameter logistic regression analysis

As simple models of linear regression might not be adequate for biological systems, the four-parameter logistic regression (4PL) model was used instead. This model is commonly used for dose-response assays, but as the different temperatures can be viewed as different doses of the parameter temperature, this model should fit well (Dinse, 2011).

The general equation for 4PL is given in equation 4. The logarithmic reduction at a certain temperature depends on the lower and upper asymptotes that can be reached, the Hill's slope of the curve and the point of inflection.

$$LR_T = d + \frac{a-d}{1 + \left(\frac{T}{c}\right)^b} \quad (4)$$

where

$LR_T$  is the logarithmic reduction at a certain temperature

$a$  is the lower asymptote (the lower detection limit for the  $LR$ )

$d$  is the upper asymptote (the highest possible  $LR$  or total reduction)

$c$  is the point of inflection

$b$  is the Hill's slope of the curve

$T$  is the temperature (in °C)

### 3.9.3. Linear regression analysis

To analyse whether the different rinsing temperatures do have an influence on the logarithmic reduction during the dishwasher cycle, linear regression was used. The three rinsing temperatures were analysed combined with two different main cleaning temperatures. The general equation for the linear regression is given in equation 5.

$$LR_{TC} = e \cdot TC + f \quad (5)$$

where

$LR_{TC}$  is the logarithmic reduction at a certain cleaning & rinsing temperature combination

$e$  is the slope of the line

$f$  is the vertical /y-intercept

$TC$  is the chosen cleaning temperature (in °C)

#### **3.9.4. Random forest analysis**

Random forest analysis is a machine learning technique that can be used to perform regression analysis and classification of data (Breiman, 2001; Ho, 1998; Jiang *et al.*, 2013; Wiener, 2003). Used together with principal component analysis, it can be used to find the factors in a set of variables that have most influence on the outcome. While principal component analysis alone is normally used for normally distributed data, random forest analysis is strong in the use for data that are not necessarily normally distributed. Random forest analysis combined with Principal component analysis was used to determine the factors that had the highest influence on the microbial reduction in the test performed for this thesis.

To analyse the data obtained during the work in the thesis, Orange software developed by Bioinformatics Lab at University of Ljubljana, Slovenia, in collaboration with the open source community, was used (Demšar *et al.*, 2013).

#### **3.10. Cross-contamination**

The term cross-contamination in this thesis is defined as transfer from microorganisms from one biomonitor to another biomonitor. Cross-contamination was detected in the dishwasher tests, when bacterial cells were transferred to biomonitors of the other tested species as the colonies of the tested strains were macroscopically clearly distinguishable from each other on the agar plates.

## 4. Results

### 4.1. Pre-test results

#### 4.1.1. Heat resistance testing

The heat resistance test according to DIN SPEC 10534 has proven the heat resistance of *M. luteus* DSM 1790, *M. luteus* DSM 20030<sup>T</sup> and *M. luteus* DSM 28269 with all tested temperatures with exposures up to 45 min. Only in the longest test duration of 90 min and the highest tested temperature of 65 °C, differences became visible. The results are shown in Table 8.

**Table 8: Results of the heat resistance test of the different *M. luteus* strains. *E. faecium* DSM 2146 acted as positive control. None of the non-inoculated test tubes used as negative control showed any growth.**

positive test tubes under the given temperature and contact time					
contact time	temperature	microorganism			
		<i>E. faecium</i> DSM 2146	<i>M. luteus</i> DSM 1790	<i>M. luteus</i> DSM 20030 <sup>T</sup>	<i>M. luteus</i> DSM 28269
15 min	45 °C	3/3	3/3	3/3	3/3
	55 °C	3/3	3/3	3/3	3/3
	65 °C	3/3	3/3	3/3	3/3
45 min	45 °C	3/3	3/3	3/3	3/3
	55 °C	3/3	3/3	3/3	3/3
	65 °C	3/3	3/3	3/3	3/3
90 min	45 °C	3/3	3/3	3/3	3/3
	55 °C	3/3	3/3	3/3	3/3
	65 °C	3/3	3/3	0/3	1/3

The three tested *M. luteus* strains (DSM 1790, DSM 20030<sup>T</sup> and DSM 28269) show a heat resistance similar to *Ent. faecium* DSM 2146 in all tests at 45 °C and 55 °C.

At a test temperature of 65 °C and contact times of 15 min or 45 min, the three *M. luteus* strains show growth in all of the test tubes, as does *Ent. faecium* DSM 2146.

The only difference between the tested microorganisms was detected with a test temperature of 65 °C and a contact time of 90 min: here, *Ent. faecium* DSM 2146 as well as *M. luteus* DSM 1790 show growth in all test tubes. *M. luteus* DSM 20030<sup>T</sup> does not show any growth at these conditions, while *M. luteus* DSM 28269 shows growth in one of the three test tubes.

#### 4.1.2. Choice of the soil matrix

Table 9 gives an overview of findings during the pre-test to identify the best possible soil matrix. The numbers given are those from the materials and methods section (for details see 3.4.1). The findings column briefly summarizes the relevant observations during the pre-tests.

**Table 9: Overview of several pre-tested soil matrices and the findings.**

matrix test	findings						
	initial count variations	constant initial counts	initial bacterial count cannot be determined	initial count too low for experiments	recovery of microorganisms in short or low-temperature cycles	no/ low recovery in short or low-temperature cycles	remaining count depends on factor levels
1	x				x		
2		x				x	
3		x				x	
4		x				x	
5			x			x	
6			x			x	
7	x			x	x		
8				x			
9				x		x	
10		x			x		
11		x			x		
12	x					x	
13				x		x	
14		x			x		x

Several of the matrices tested show constant initial counts or recovery of microorganisms after the short or low-temperature cycles. Only matrix 14 shows a differentiation in the remaining counts when different combinations of the factors duration, temperature and detergent are used.

### **4.1.3. Influence of the extraction parameters on the recovery of the microbial load**

#### **4.1.3.1. Extraction of dishwasher biomonitors**

The current standards DIN 10512 and DIN SPEC 10534 state, that the biomonitors used in microbiological test for dishwashers should be extracted in 10 mL 0.9% NaCl solution (Deutsches Institut für Normung e. V., 2008, 2019) in tubes, *e.g.* on a shaker. The standards do not give further details. As the duration of the extraction, the addition of glass beads as in DIN EN 13697 (Deutsches Institut für Normung e. V., 2012) or the speed of the shaker can all influence the recovery rate, this was tested. In these tests, different media volumes, different amounts of glass beads, the orientation of the biomonitor in the extraction tube and different extraction speeds were investigated to find the combination with the best recovery rate. To make sure that the test conditions would not harm the test organisms, the Gram-positive *M. luteus* DSM 1790 (see Figure 8) was used as well as the Gram-negative *Ps. aeruginosa* DSM 939 (see Figure 9).

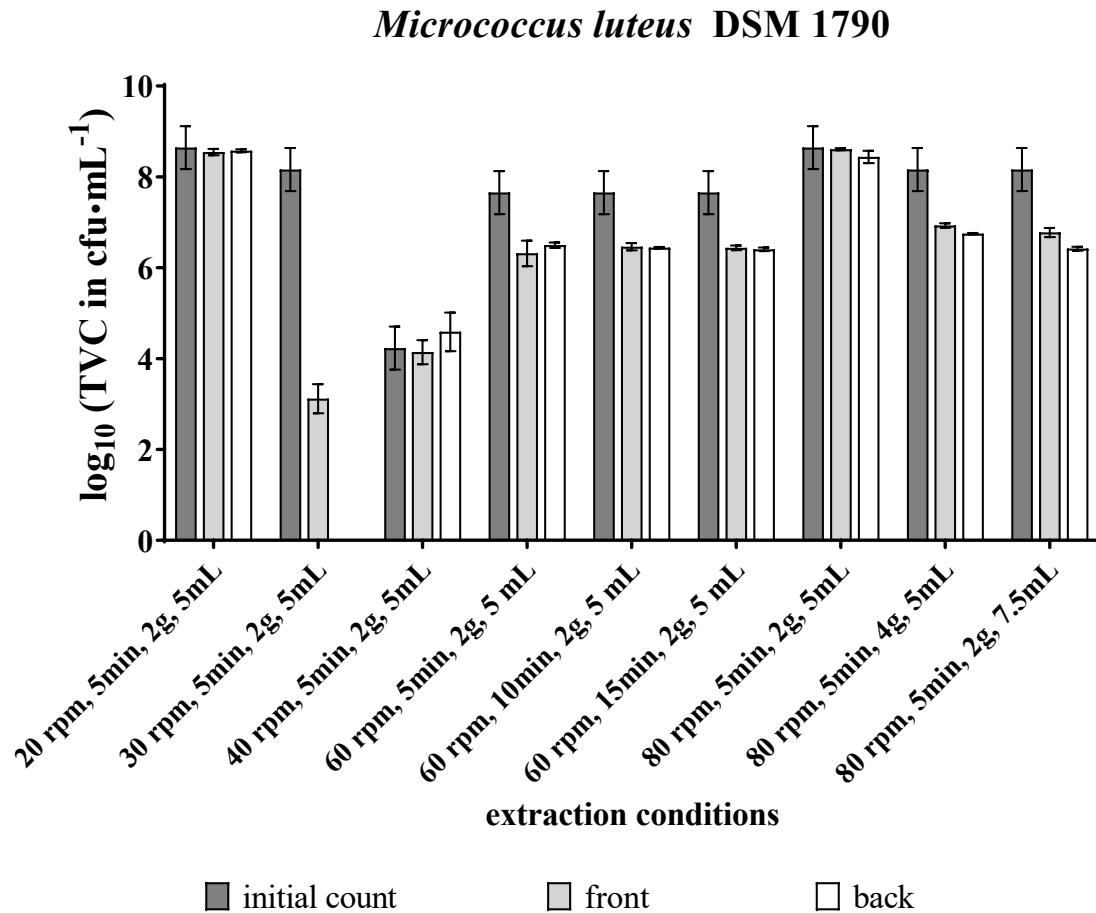

**Figure 8: Recovery of the microorganisms during the extraction of the biomonitors contaminated with *M. luteus* DSM 1790 compared to the bacterial load of the inoculation solution. For each set of extraction parameters, the mean with standard deviation of three independent repeats is shown for biomonitors oriented with the contaminated side towards the glass beads (front) or away from the glass beads (back).**

For *M. luteus* DSM 1790, the recovery during extraction is lowest with the speed of the tilt-/roller mixer set to 30 rpm. In this setting, only the extraction with the front (contaminated side) of the biomonitor facing the glass beads was tested. For all other combinations, the extraction was tested with the front (contaminated side) and with the back (uncontaminated side) facing the glass beads during extraction. The orientation of the biomonitor itself did not result in statistically significant differences for *M. luteus* DSM 1790.

All extractions with 30 rpm and 60 rpm resulted in low recovery rates of the initial load by extraction with the recovery being higher at 60 rpm than 30 rpm. Then, the highest available setting of the tilt-/roller mixer (80 rpm) was tested to see, whether a difference could be seen with the higher extraction speed. The recovery was found to be in the range of the initial count,



when the standard deviation is taken into account. In some cases, more cells were detected in the EL than in the original inoculation solution. As the viable count of the inoculation solution varied, this observation is within the natural variation often found in microbiological enumerations. An extraction speed of 20 rpm was also tested and resulted in similar recoveries but giving slightly higher standard deviations. In the experiments with an extraction speed of 40 rpm, the initial load was lower compared to the other tests. Here, similar recoveries were found, but the standard deviation with this extraction speed was highest.

For the extraction speed of 80 rpm, the recoveries detected with higher amounts of glass beads or more EL were lower compared to the recovery with 2 g of glass beads and 5 mL EL.

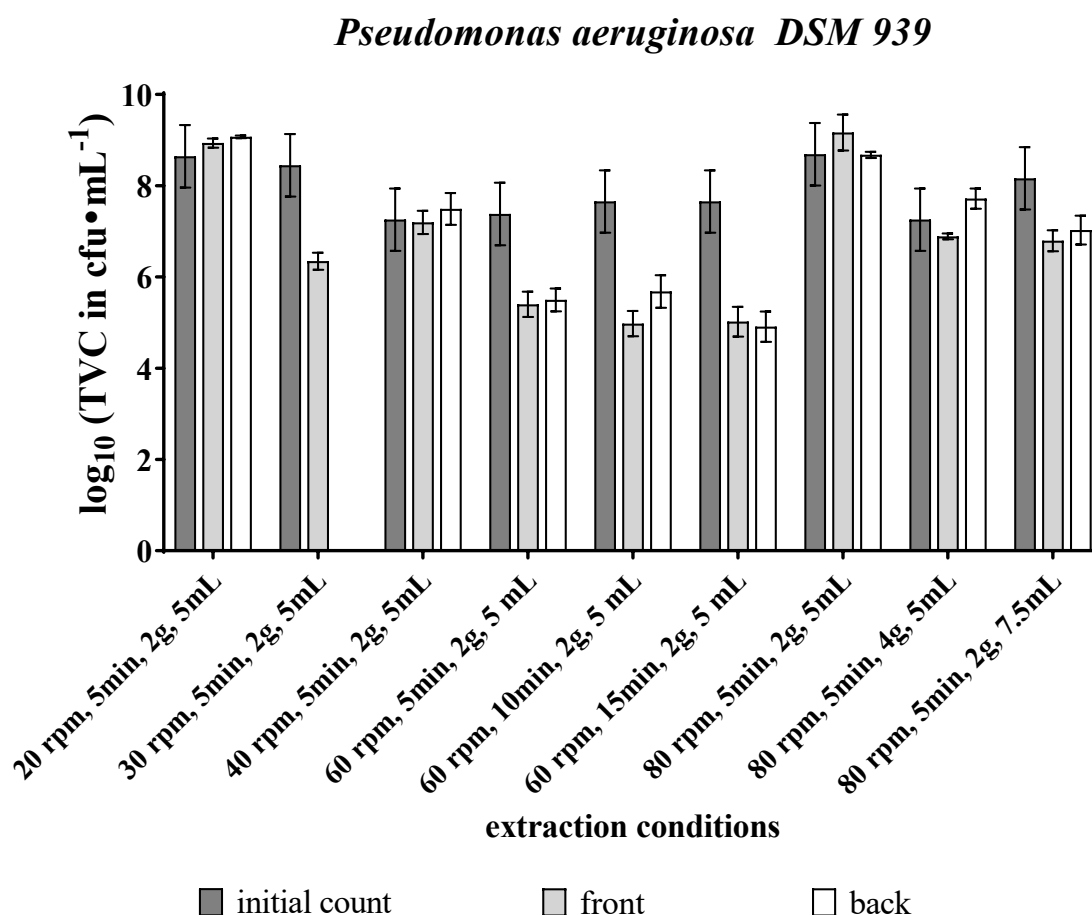

**Figure 9:** Recovery of the microorganisms during the extraction of the biomonitors contaminated with *Ps. aeruginosa* DSM 939 compared to the bacterial load of the inoculation solution. For each set of extraction parameters, the mean with standard deviation of three independent repeats is shown for biomonitors oriented with the contaminated side towards the glass beads (front) or away from the glass beads (back).

Similar extraction tests were also performed with biomonitors inoculated with *Ps. aeruginosa* DSM 939. This Gram-negative organism was chosen as it has shown to be less resistant to chemical and physical influences in former studies. As for *M. luteus* DSM 1790, the recovery was lowest for extraction speeds of 30 rpm and 60 rpm. Again, the best recoveries were detected with 20 rpm and 80 rpm. The recoveries detected with higher volumes of EL or more glass beads were significantly lower, while the orientation of the biomonitor at 80 rpm gave no statistically significant differences.

Based on these results, the best recoveries with the lowest standard deviations were achieved when using an extraction speed of 80 rpm, 2 g glass beads, 5 mL EL and the inoculated side facing the glass beads. Therefore, it was chosen to do all extractions in the dishwasher test series with these extraction conditions.

#### **4.1.3.2. Extraction of biomonitors for hand dishwashing and tests in the tergotometer**

As due to the spatial restrictions in the tergotometer, biomonitors different from those in the dishwasher had to be used and round coupons were the best option, the extraction of these biomonitors had to be done in a different manner. The extraction was performed in 6-well plates so, as a first step different amounts of glass beads and EL were tested. Especially with the glass beads, an amount of 3 g was determined to give the best mechanical result during extraction; with less or more glass beads, the extraction was disrupted by a position change of the biomonitor during extraction which led to hindrance of the extraction. The volume of the extraction liquid is determined by the height of the glass beads in the wells and by the total volume the wells can hold. The best parameters for extraction were tested to be the ones presented in the materials and methods section: 3 g glass beads, 5 mL EL and the contaminated side towards the glass beads to allow for mechanical action on the contaminated side. As the extraction in the 6-well plates is performed on a digital rocking shaker, the movement is limited to tilting in one direction. For this reason, the plate was turned by 90 ° after 5 minutes to achieve a movement of the biomonitors in the other direction as well to have a mechanical influence over the complete surface of the biomonitor.

#### 4.2. Influence factors in hand dishwashing

In hand dishwashing, the four influence factors temperature, detergent, duration and mechanical action defined by Sinner determine the cleaning result (Sinner, 1960). All hand dishwashing tests have been performed with biomonitors for hand dishwashing (see 3.6) with different test parameters, varying the water temperature, comparing dishwashing with and without detergent and application of either none, 10 or 20 scrubbing cycles. The results are shown in Figure 10.

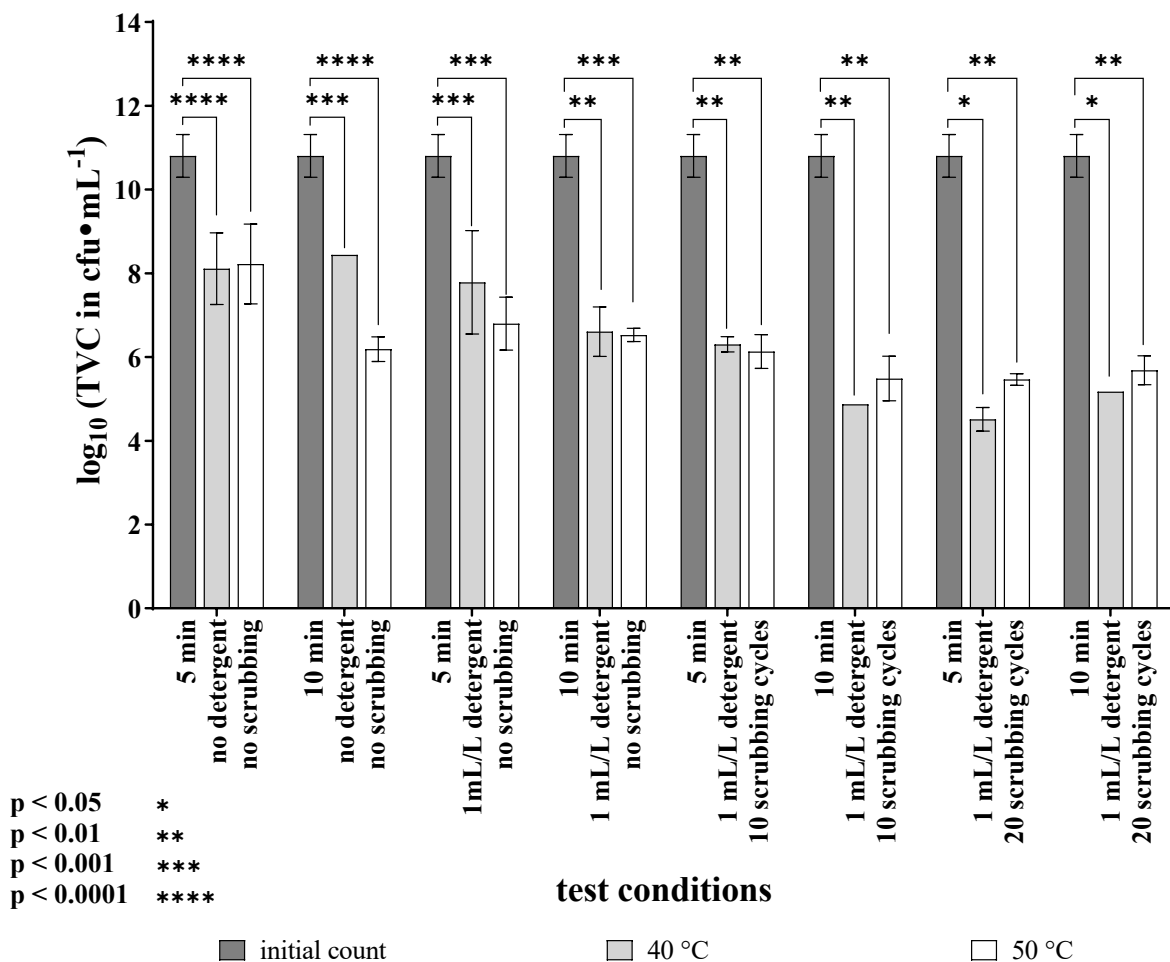

**Figure 10: Microbial counts on biomonitors contaminated with *M. luteus* DSM 1790 in BAMS after hand dishwashing using different test parameters and the respective initial microbial counts. The asterisks represent statistically significant lower microbial counts compared to the initial counts.**

The initial count on the biomonitors was  $2.1 \times 10^{11}$  cfu · mL<sup>-1</sup>. All test conditions applied resulted in significantly lower bacterial loads on the biomonitors after the tests compared to the initial microbial counts.

The finding that more scrubbing cycles lead to higher remaining counts on the biomonitors at a test temperature of 50 °C compared to a temperature of 40 °C was unexpected.

#### 4.2.1. Temperature

Although the temperature in hand dishwashing is not a fixed measure and may range from ambient temperature in some methods up to 50 °C or even above, in this thesis only two hand dishwashing temperatures were examined. Those were set to 40 °C and 50 °C as these are also used in some household dishwasher programmes. Figure 11 shows the data already presented in Figure 10 but without the data of the initial microbial counts.

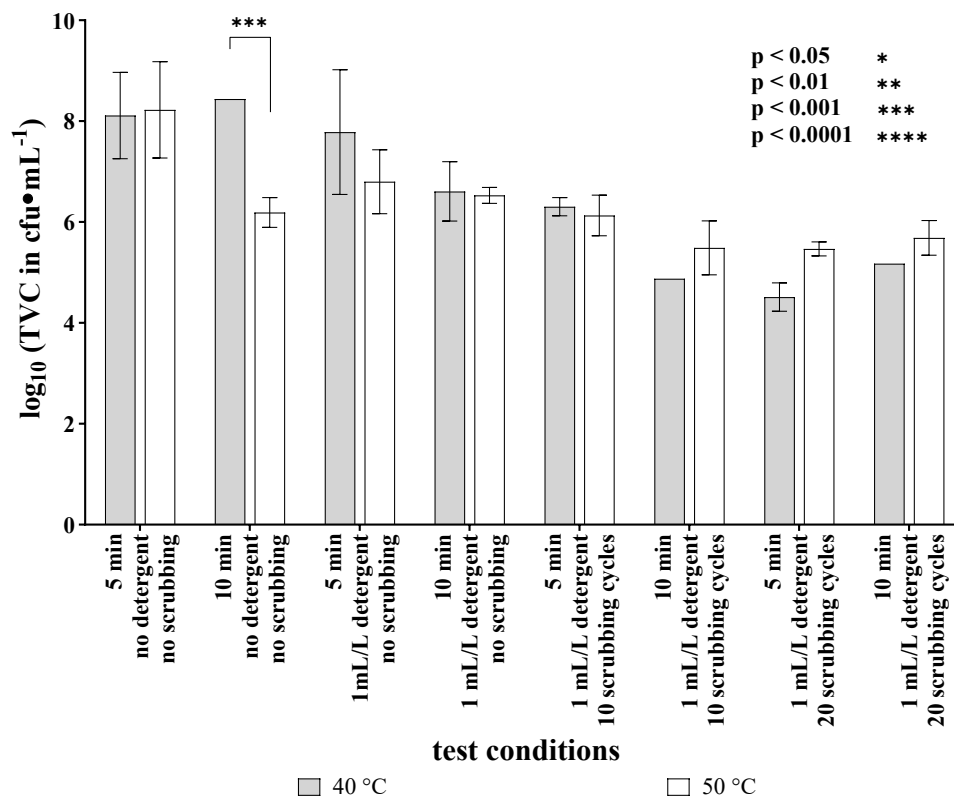

**Figure 11: Differences in the LR caused by the change of the water temperature from 40 °C to 50 °C in hand dishwashing tests with different test parameters. The asterisks represent statistically significant microbial counts between the two observed temperatures.**

The increase of the water temperature from 40 °C to 50 °C in hand dishwashing did lead to decreased microbial loads on the biomonitor with most of the parameter combinations. Only in the tests, in which scrubbing cycles were applied, the increase of the temperature did not result in a reduction of the microbial load. Here, the remaining loads were equal or higher with the higher temperature. This finding was unexpected and does not meet Sinner's hypothesis.

In the tests without detergent or mechanical action by scrubbing, the remaining microbial load was significantly lower when the temperature was increased from 40 °C to 50 °C.

#### **4.2.2. Detergent**

In the hand dishwashing tests, a comparison between setups without detergent and setups with added detergent were compared.

The addition of a commercial market detergent in a concentration given by the manufacturer ( $1 \text{ mL} \cdot \text{L}^{-1}$ ) does not lead to significantly lower microbial loads on the biomonitors compared to the tests without detergent. This was independent of the cleaning temperature and duration. The initial microbial load is reduced by 3 to 4 logarithmic steps, with a high standard deviation especially in the short dishwashing experiments. None of the detected differences between the tests with or without dishwashing detergent were significant.

#### **4.2.3. Duration**

In the hand dishwashing tests, setups with durations of 5 min and 10 min were used. With a test temperature of 40 °C, the prolongation of the test duration did lead to reduced microbial load in tests with added detergent but without scrubbing as well as in tests with detergent and 10 scrubbing cycles. The increase is visible but not statistically significant. When the tests with added detergent and 20 scrubbing cycles are compared, the addition of extra scrubbing cycles results in slightly increased remaining microbial loads, but again, the difference is not statistically significant.

With the test temperature of 50 °C, the highest observed reduction caused by the duration was found in the tests without detergent and without scrubbing. The increase of the cleaning temperature led to up to 2.5 log-steps lower remaining load, but again the differences are not statistically significant due to the high standard deviations. This is also true for the slight increase that is observed in the tests with detergent and 20 applied scrubbing cycles.

#### 4.2.4. Mechanical action

The mechanical action is the last factor that was analysed in the hand dishwashing experiments. Figure 12 shows the remaining counts on the biomonitors at the two test temperatures for durations of 5 min and 10 min with different numbers of scrubbing cycles.

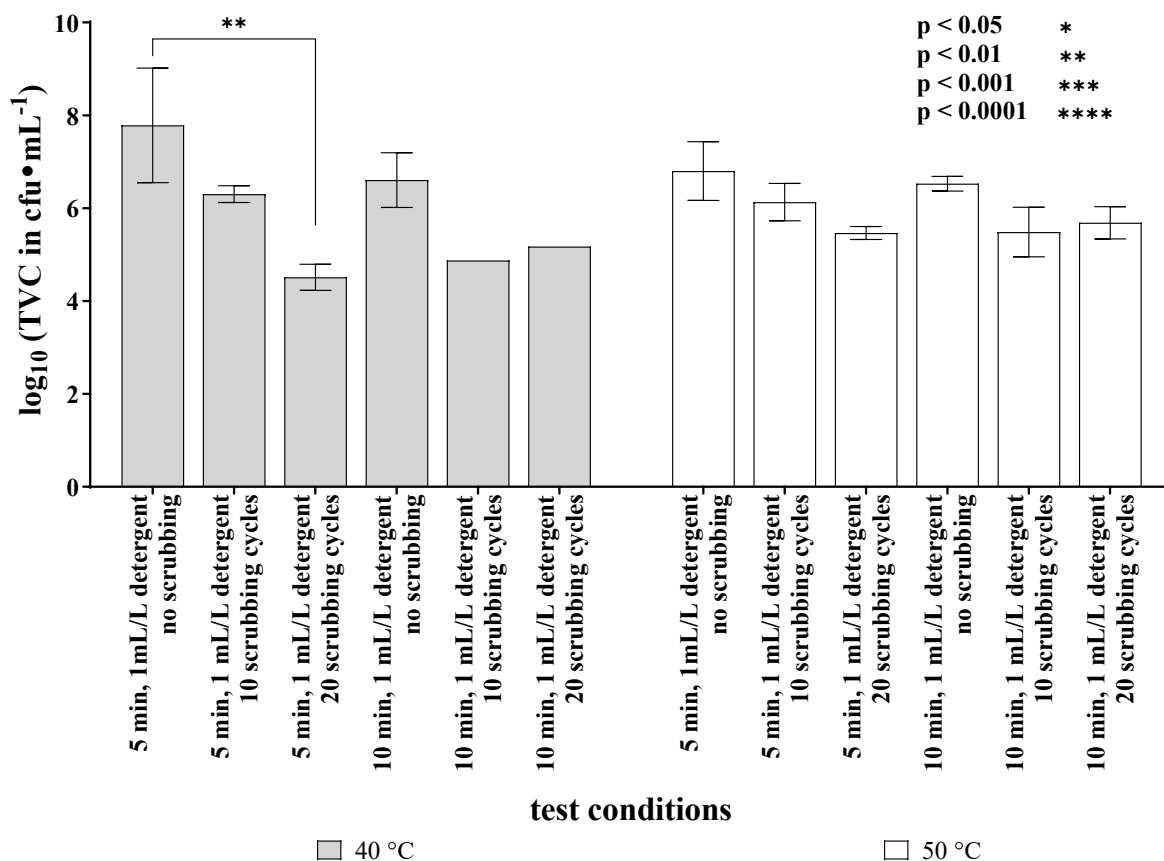

Figure 12: Microbial load on stainless steel biomonitors contaminated with *M. luteus* DSM 1790 after hand dishwashing with different intensities of mechanical action applied to the surfaces. Significant differences are indicated by asterisks.

In the short hand dishwashing tests with a soaking duration of 5 min, mechanical action leads to an increase of the reduction in all tested cases. Of the differences observed, the application of 20 scrubbing cycles in tests with detergent and 40 °C water temperature significantly increased the reduction.

The differences observed in the longer tests and in the tests with a temperature of 50 °C are statistically not significant.

All of the factors contribute to the reduction in manual dishwashing and as not all parameter combinations have been tested at this point (for example the combinations without detergent but with scrubbing are missing), it cannot be conclusively assessed which of the factors contributes most to the observed reduction. The influence of the individual factors will be examined more closely in the discussion.

### 4.3. Investigation of influence factors in the tergotometer

The experiments in the tergotometer can be used to investigate the influence of the detergent and the duration under strictly controlled conditions. As in hand dishwashing before, the four aspects of Sinner's circle are analysed. Temperatures of 45 °C, 50 °C, 55 °C and 65 °C were tested for *Ent. faecium* DSM 2146, *M. luteus* DSM 1790 and *S. aureus* DSM 939. For the latter, the additional temperature of 60 °C was included. The results are shown in Figure 13 for *Ent. faecium* DSM 2146, Figure 15 for *M. luteus* DSM 1790 and Figure 17 for *S. aureus* DSM 939.

Figure 13 shows the SLRs received with different test parameters. The mean initial count on the biomonitors was  $8.59 \times 10^8 \text{ cfu} \cdot \text{mL}^{-1}$ . For the shortest test durations of 5 min, the tests at 65 °C showed an increase in the reduction with addition of bleach-free detergent compared to tests without detergent as expected. The addition of activated oxygen bleach further increased the reduction. The observed reductions at the lower temperatures resulted in higher standard deviations and especially the tests with temperatures of 45 °C and 55 °C unexpectedly had the highest reductions in the tests without detergent.

In the tests with a soaking duration of 10 min and a water temperature of 45 °C, the SLR reached 3 without detergent, 4 with bleach-free detergent and 5 with detergent containing activated oxygen bleach. A similar picture was found in the tests with a temperature of 55 °C, giving higher reductions compared to those at 45 °C. This is what can be expected according to Sinner's hypothesis.

With a temperature of 50 °C, complete reduction was achieved except for the test with bleach-free detergent. Here, the higher standard deviation indicates that complete reduction was not reached on all biomonitors. However, it is unexpected that the achieved reductions were higher than with the higher test temperature of 55 °C.

In the 65 °C tests, there is a decrease from ND to DT to AOB with high standard deviations in all tests. This is the reverse of what can be expected according to Sinner's hypothesis.



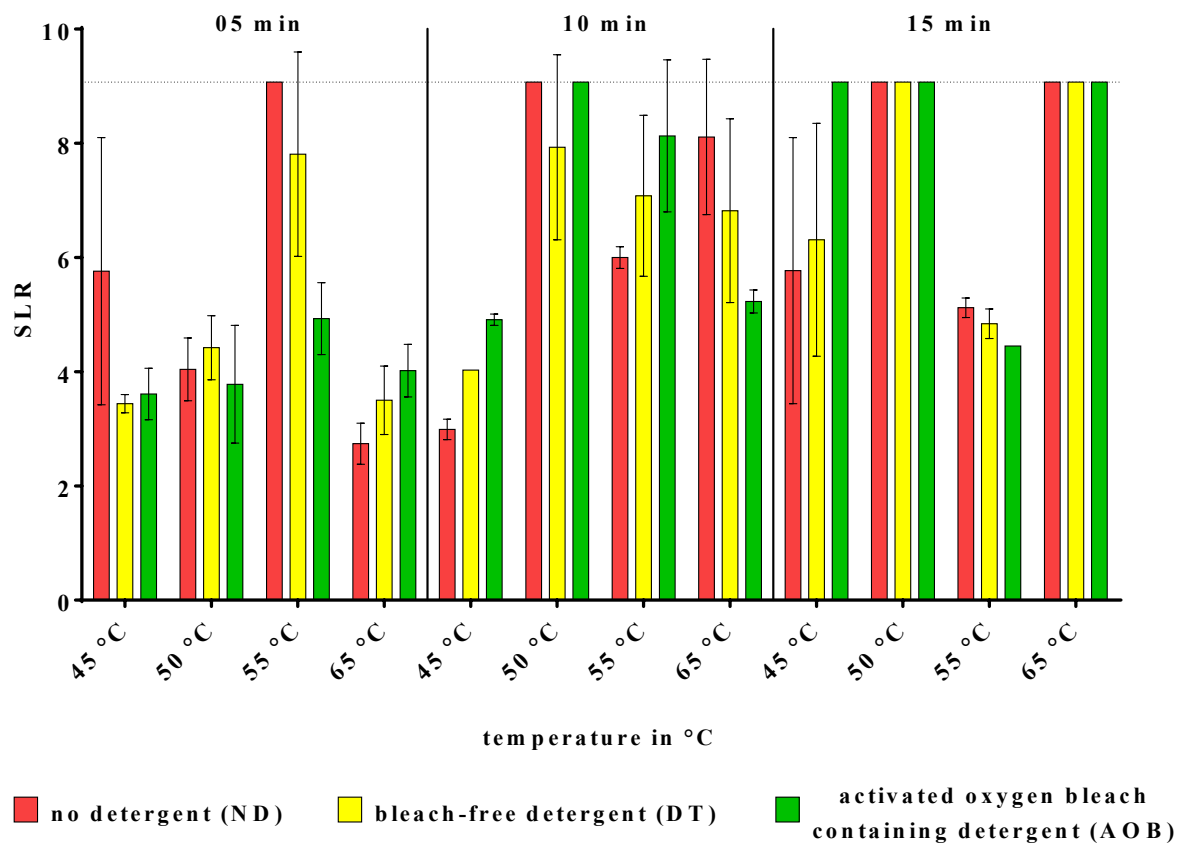
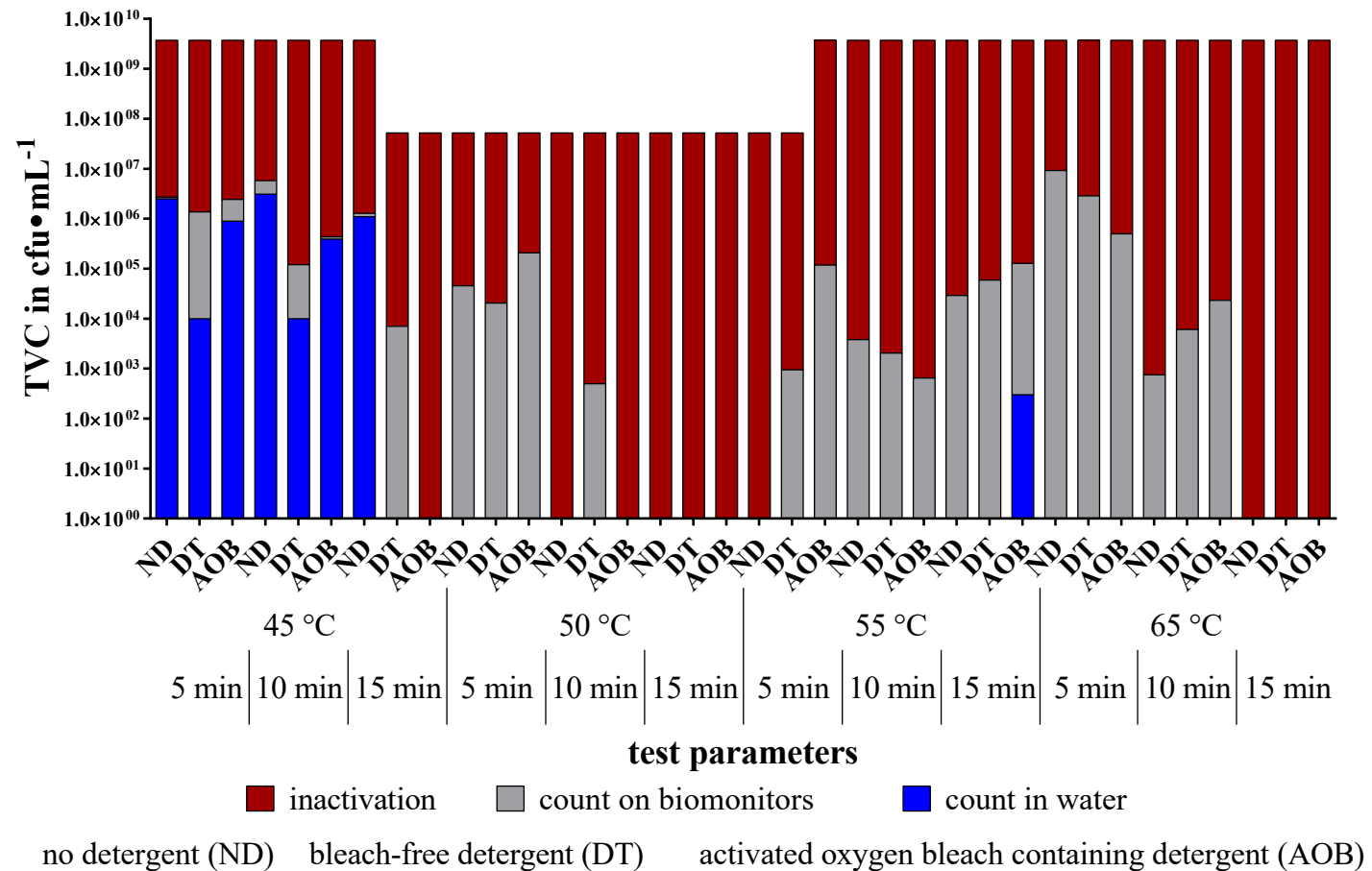

**Figure 13: Standardized logarithmic reductions (SLR) on biomonitors contaminated with *Ent. faecium* DSM 2146 in BAMS and tested under the given parameters in the tergotometer. The dotted line indicates the maximum SLR. Means with standard deviations from 3 biomonitors are shown.**

Next to the microbial load on the biomonitors, in the tergotometer tests, the microbial load of the water in the vessels was determined. These results, together with the remaining count on the biomonitors and the calculated inactivation of the microbial load for the different test conditions for *Ent. faecium* DSM 2146 are given in Figure 14.

Here, the microbial loads of the water, and the biomonitors as well as the microbial inactivation (initial load reduced by count on biomonitors and count in water) are shown. In the tests at 45 °C (except for the tests with a duration of 15 min with DT and AOB where no load was detected in the water), the microbial load in the water was higher compared to the other temperatures. The load in the water is between  $1 \times 10^4$  cfu · mL<sup>-1</sup> (5 min, DT) and  $3.1 \times 10^6$  cfu · mL<sup>-1</sup> (10 min, ND). In the tests with temperatures of 50 °C and 65 °C, no viable count could be detected in the water at the end of the tests. In the 55 °C tests, this was only successful in the 15 min test with activated oxygen-bleach containing detergent, showing a load

of  $3 \times 10^2$  cfu · mL<sup>-1</sup>. The fact that remaining load was detected in the water under these circumstances was unexpected as the higher temperature and the addition of activated oxygen bleach are expected to lead to higher reductions.



**Figure 14: Overview of the microbial counts of *Ent. faecium* DSM 2146 at the end of the test in the tergotometer. Recovered count from the biomonitors in the EL are given together with the count in the water. The red parts indicate the number of inactivated bacteria compared to the initial counts. The different heights of the bars are due to different initial counts.**

Figure 15 shows the SLRs registered in tests with *M. luteus* DSM 1790 in the tergotometer. The initial counts in these tests were  $8.6 \times 10^8 \text{ cfu} \cdot \text{mL}^{-1}$ . The SLRs generally ranged between 2.5 and 5.7 in tests with different durations and detergents when test temperatures of up to 55 °C were applied. The exceptions from that are the tests with durations of 5 min or 10 min and a temperature of 55 °C. Here, the reductions were lower, ranging from 1.6 (ND, DT) to 1.9 (AOB) with 5 min durations and 1.9 (ND) to 3.2 (DT, AOB) with a duration of 10 min. The finding that these parameter combinations resulted in lower reductions than tests with lower temperatures was unexpected and will be discussed later.

When test temperatures of 65 °C were applied, the reductions were generally higher, ranging between 4.74 (5 min, AOB) to complete reductions (e.g. 15 min, DT and AOB).

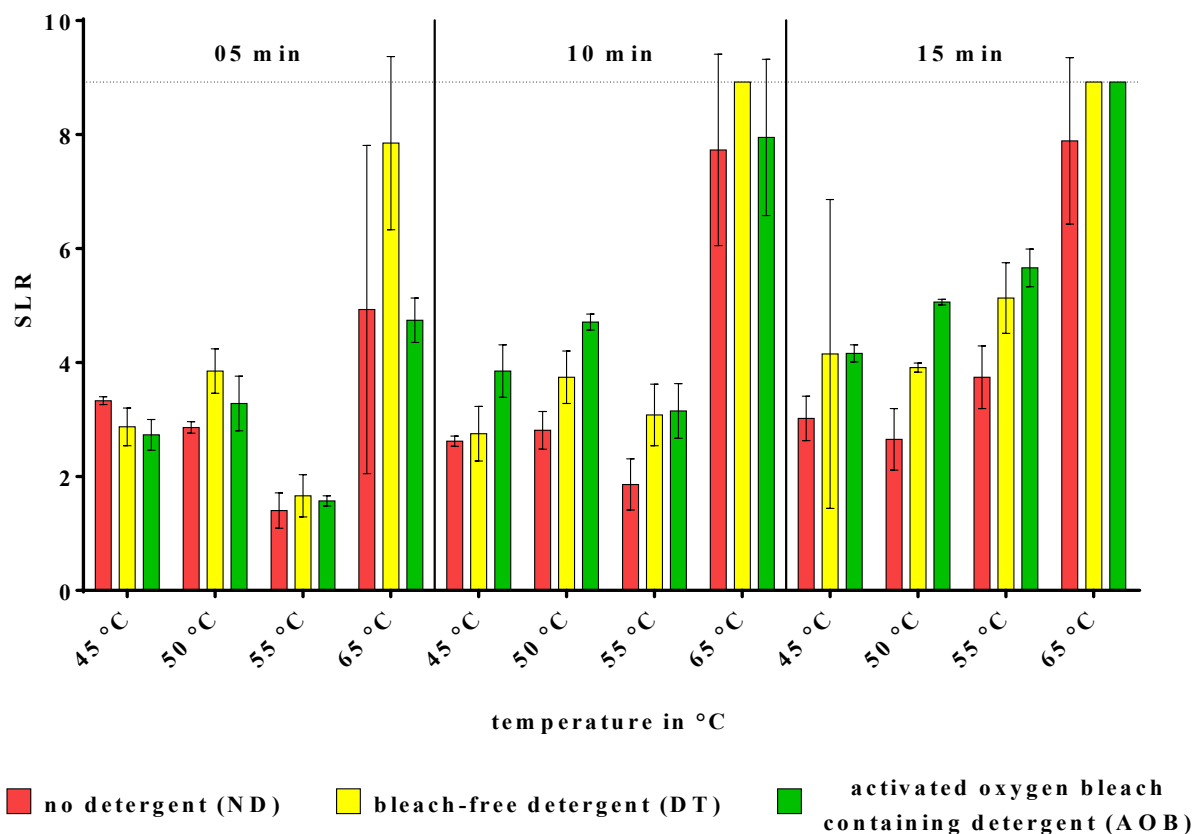

**Figure 15: Standardized logarithmic reductions (SLR) on biomonitors contaminated with *M. luteus* DSM 1790 in BAMS and tested under the given parameters in the tergotometer. The dotted line indicates the maximum SLR. Means with standard deviations from 3 biomonitors are shown.**

Next to the remaining counts on the biomonitors, the microbial count in the water was observed. These are given in Figure 16. In the water, remaining microbial counts could be detected in all tests with temperatures up to 55 °C and in the test at 65 °C in which AOB-containing detergent was used.

This single detection of remaining count in the water with a test temperature of 65 °C and the use of activated oxygen bleach containing detergent was not to be expected and will be considered in more detail in the discussion.

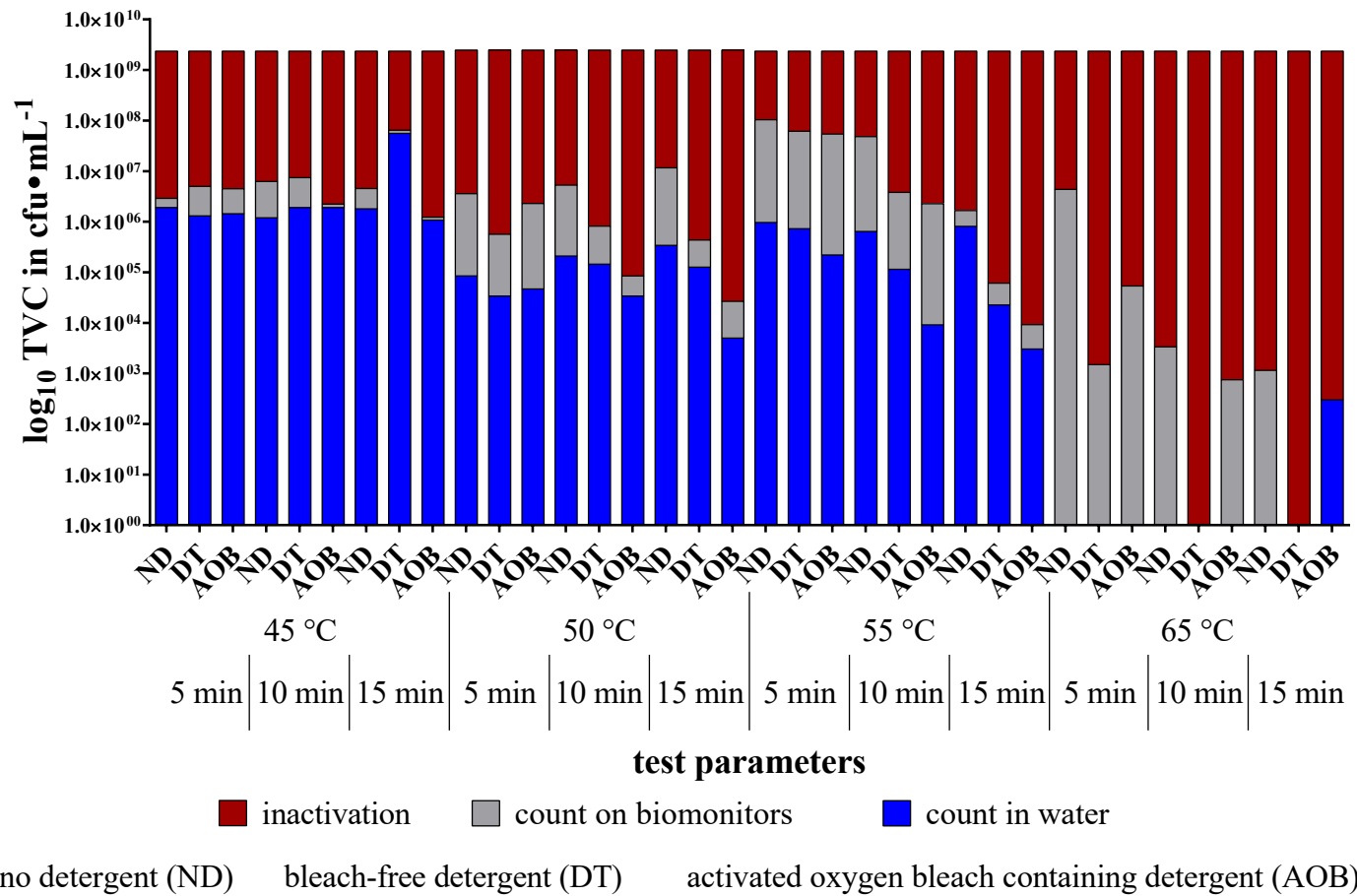

**Figure 16: Overview of the microbial counts of *M. luteus* DSM 1790 at the end of the test in the tergotometer. Recovered count from the biomonitors in the EL are given together with the count in the water. The red parts indicate the number of inactivated bacteria compared to the initial counts.**

Tests with *S. aureus* were only performed in the tergotometer (see Figure 17). The mean initial count in these tests was  $5 \times 10^9$  cfu · mL<sup>-1</sup>. Complete reductions were achieved in the 5 min tests with temperatures of 60 °C and 65 °C for tests with added bleach-free detergent. When no detergent or bleach-containing detergent was added, the reduction remained incomplete on some biomonitors. With lower temperatures, the reductions were between 1.77 (50 °C) and 2.82 (55 °C) in tests without detergent and reached values between 2.06 (AOB, 50 °C) and 4.1 (DT, 54 °C). In the 10 min tests, the values were comparable for 45 °C and 50 °C. At a test temperature of 55 °C, complete reductions were reached with added detergent and reductions of 5.74 without detergent. The 15 min tests gave a more heterogeneous picture, with complete reductions from 50 °C to 60 °C with added detergent (either type) and lower reductions found at 45 °C and 65 °C. In the tests without detergent, the reductions were lowest with a temperature of 50 °C (3.08), reached 7.8 at 45 °C, full reduction at 60 °C and 6.19 at 65 °C.

For the test series with temperatures of 45 °C and 65 °C, a different biomonitor-batch was used. The differences between the two batches of biomonitors will be addressed in the discussion.

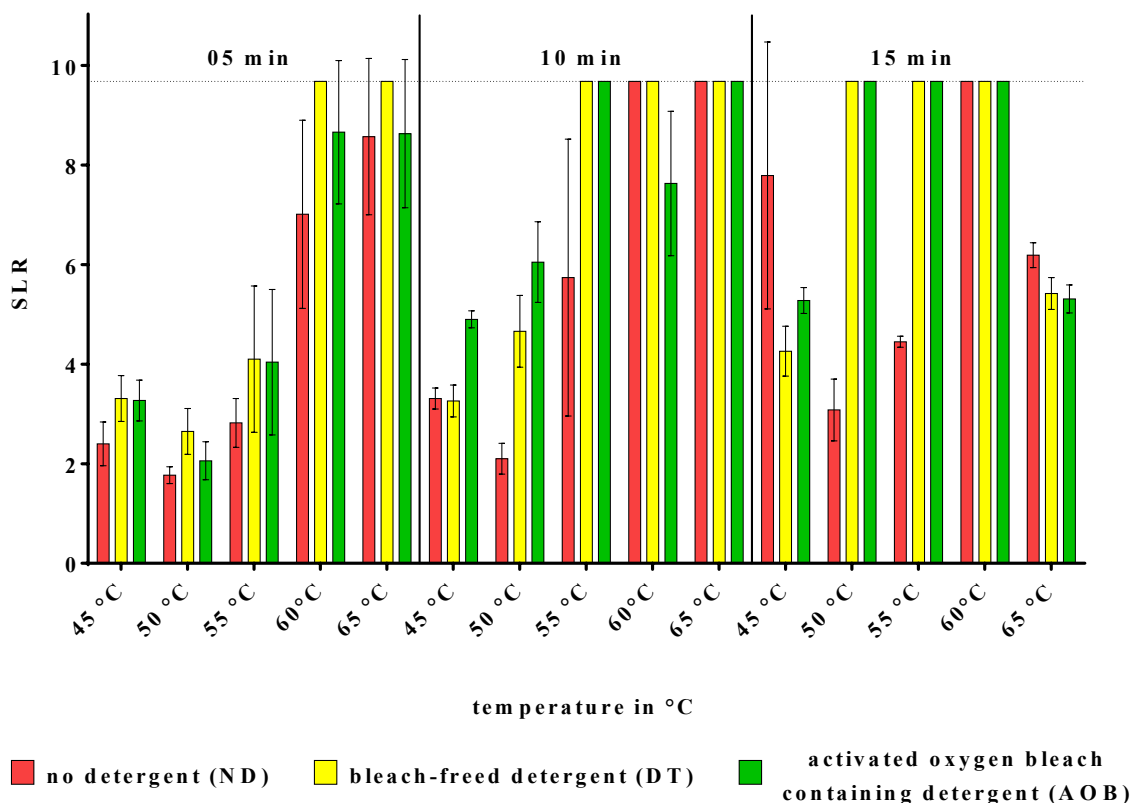

**Figure 17: Standardized logarithmic reductions (SLR) on biomonitors contaminated with *S. aureus* in BAMS and tested under the given parameters in the tergotometer. The dotted line indicates the maximum SLR. Means with standard deviations from 3 biomonitors are shown.**

When the microbial count in the water was investigated,  $1.26 \times 10^6$  cfu · mL<sup>-1</sup> were detected in the test without detergent, a duration of 5 min and a temperature of 45 °C. Similar numbers were detected in all tests at 45 °C except for those with activated oxygen-bleach containing detergent, in which no microbial load was detected in the water.

In tests with a temperature of 50 °C, the microbial load in the water ranged from  $3.9 \times 10^2$  cfu · mL<sup>-1</sup> to  $2.82 \times 10^5$  cfu · mL<sup>-1</sup> when detected with complete reduction in the 15 min tests with either bleach-free or AOB-containing detergent. In the 55 °C tests and the shortest test at 60 °C without detergent, microbial loads of  $2 \times 10^2$  cfu · mL<sup>-1</sup> to  $4.2 \times 10^4$  cfu · mL<sup>-1</sup> could be detected.

The changes in the observed reductions were investigated for the influence of the four factors of Sinner's circle; temperature (4.3.1), detergent (4.3.2), duration (4.3.3) and mechanical action (4.3.4).



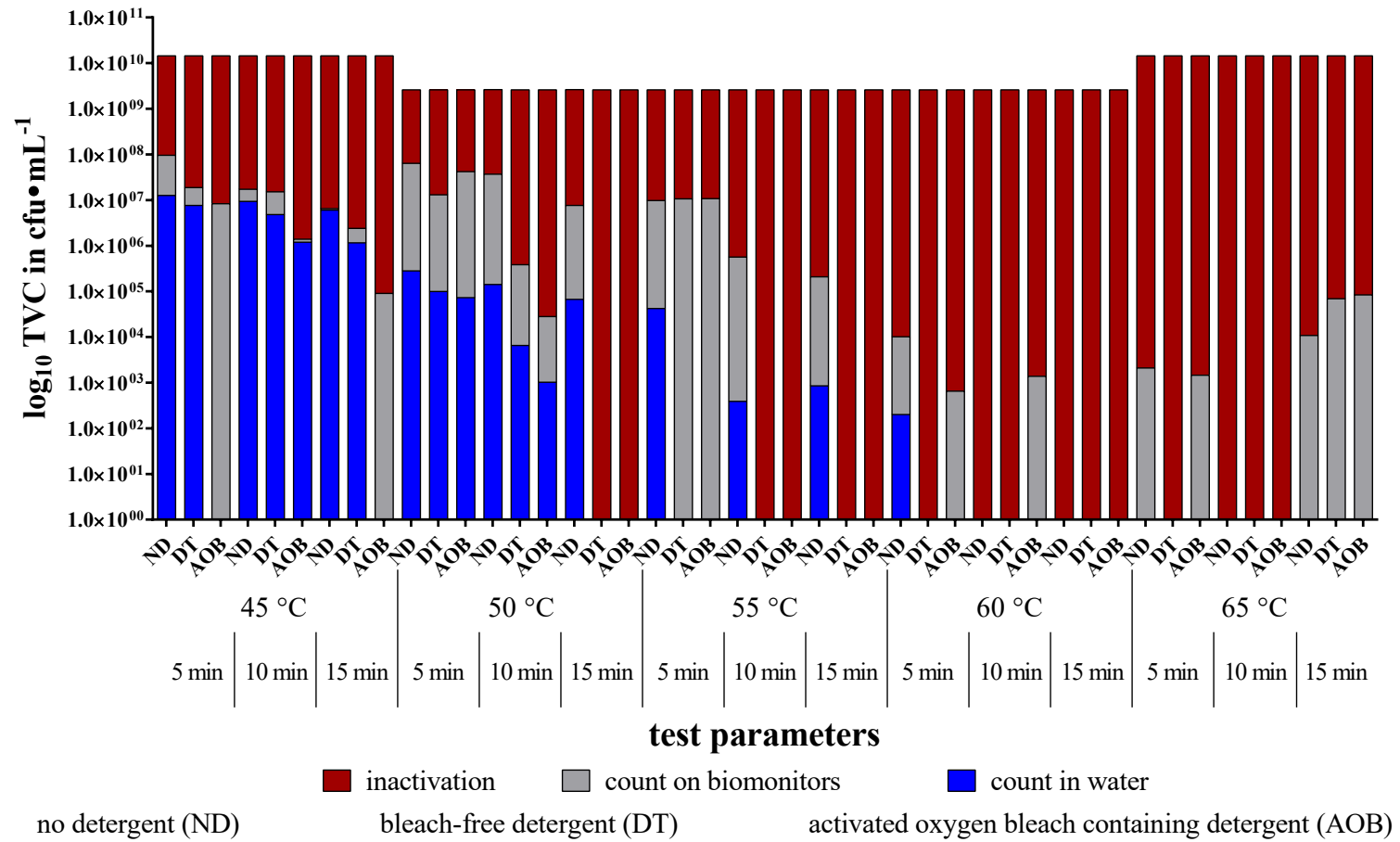
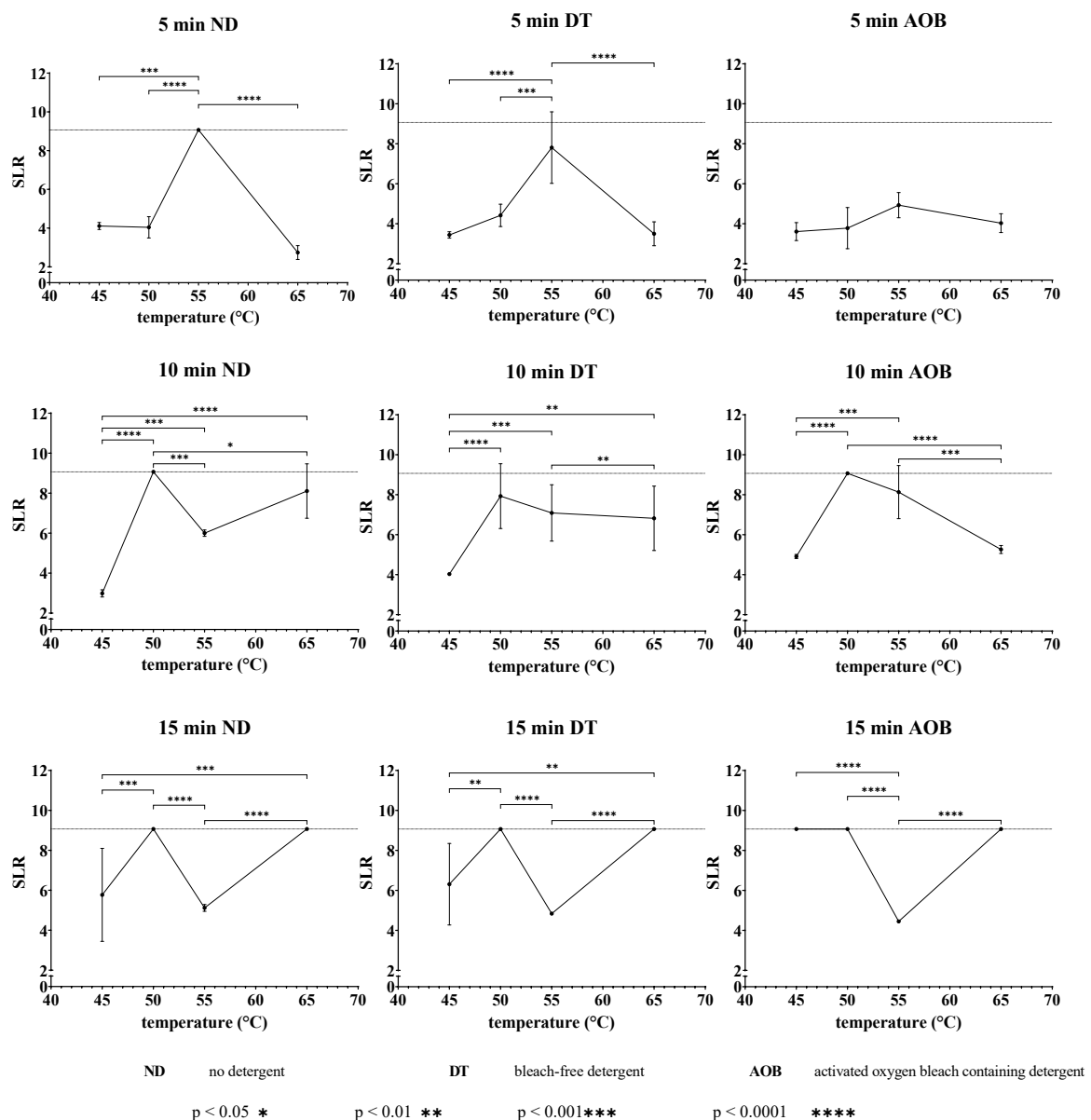

**Figure 18: Overview of the microbial counts of *S. aureus* at the end of the test in the tergotometer. Recovered count from the biomonitors in the EL are given together with the count in the water. The red parts indicate the number of inactivated bacteria compared to the initial counts. The different heights of the bars are due to different initial counts.**

### 4.3.1. Temperature

The figures for this section are all given in full size in Appendix: Full size figures.

First, the influence on the reduction of *Ent. faecium* DSM 2146 by the factor temperature is investigated for the biomonitors (Figure 19). In the 5 min tests for example, the increase of the temperature from 45 °C to 50 °C did not lead to significant changes in the SLR, while the increase from 45 °C to 55 °C did lead to significantly increased SLR values for the tests without detergent and bleach-free detergent.



**Figure 19: Overview of the standardized logarithmic reductions of *Ent. faecium* DSM 2146 on biomonitors. The dotted lines indicate the maximum SLR. Statistically significant differences in SLRs between different temperatures are marked with asterisks.**

Most remarkable are the lower SLRs at 55 °C in the 15 min tests and in both shorter test series without detergent. Possible reasons for these results will be discussed later.

In the water (Figure 20), increases of the temperature from 45 °C to 50 °C, 55 °C and 65 °C led to higher SLRs for tests without detergent and for tests with bleach-free detergent. In the tests with activated oxygen bleach containing detergent, this was also true for a test duration of 5 min. In the 10 min tests, a complete reduction was reached for all temperatures, while unexpectedly, in the 15 min tests, the reduction was incomplete at 55 °C.

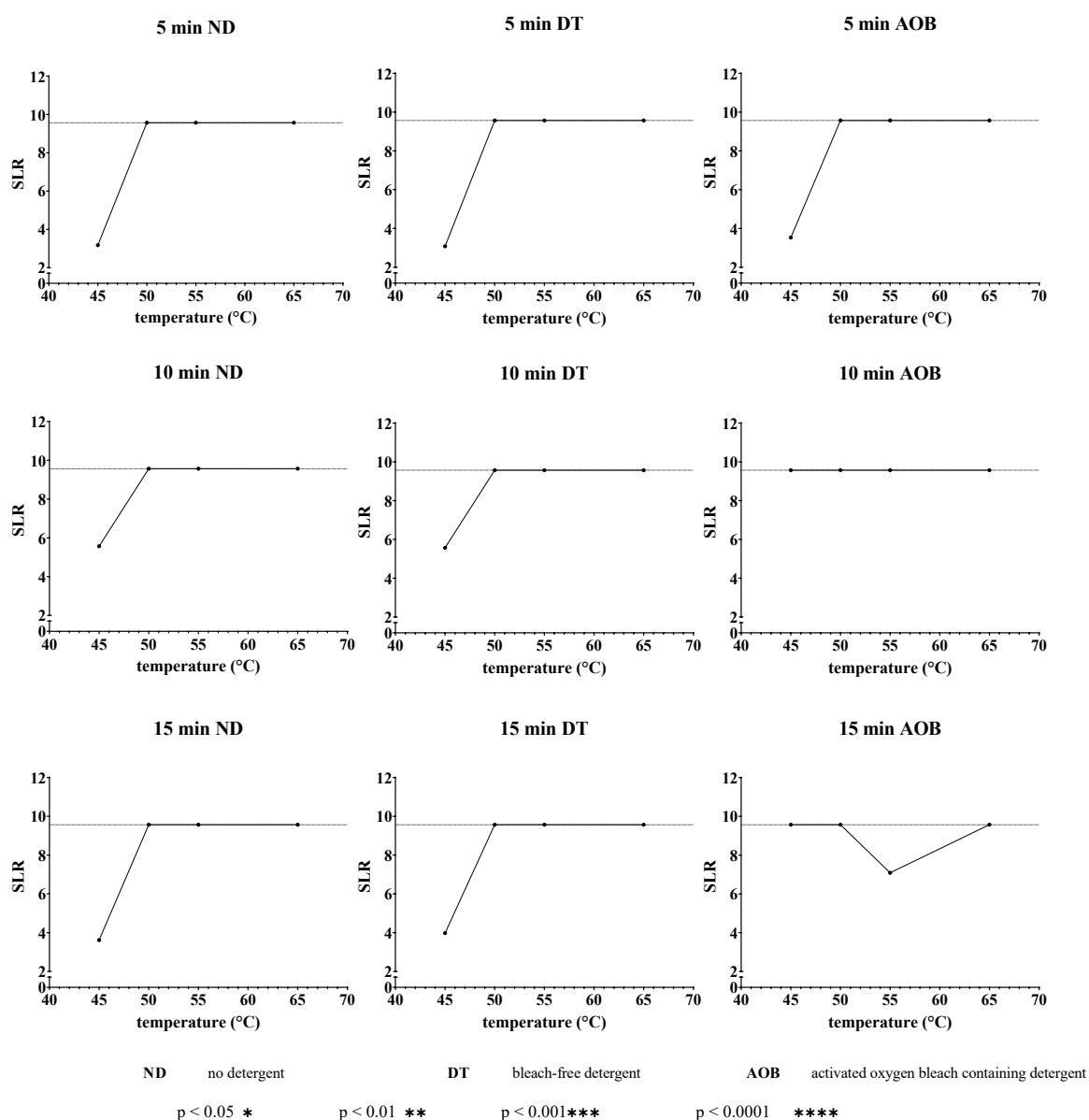

**Figure 20: Overview of the standardized logarithmic reductions (SLR) of *Ent. faecium* DSM 2146 in the water. The dotted lines indicate the maximum SLR. No standard deviations or significances are given due to the small sample size.**

The comparisons for biomonitors with *M. luteus* DSM 1790 (Figure 21) show that significant increases of the reductions on the biomonitors are visible with temperature increases from 45 °C to 65 °C, 50 °C to 65 °C and 55 °C to 65 °C. Here the reduction can be increased in nearly all tests with the exception of the tests without detergent and a shift from 45 °C to 65 °C and the test with AOB-containing-detergent and the shift from 50 °C to 65 °C.

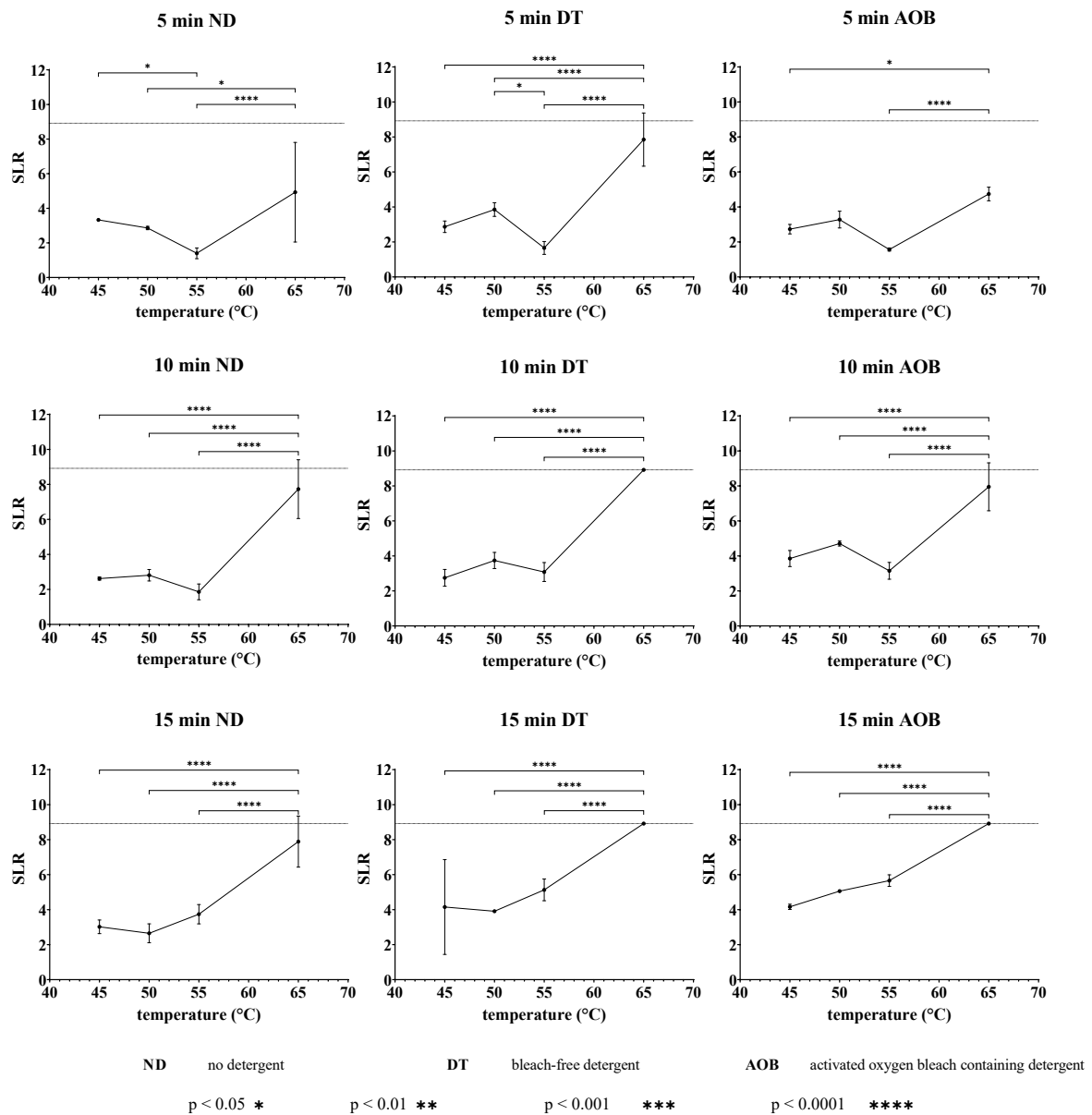

**Figure 21: Overview of the standardized logarithmic reductions of *M. luteus* DSM 1790 on biomonitors. The dotted lines indicate the maximum SLR. Statistically significant differences in SLRs between different temperatures are marked with asterisks.**

The reduction microbial load in the water (Figure 22) increased when the temperature was increased from 45 °C or 50 °C to 65 °C in all tests. The slightly higher reductions at 50 °C compared to 55 °C in all 5 min tests and tests without detergent will be discussed later.

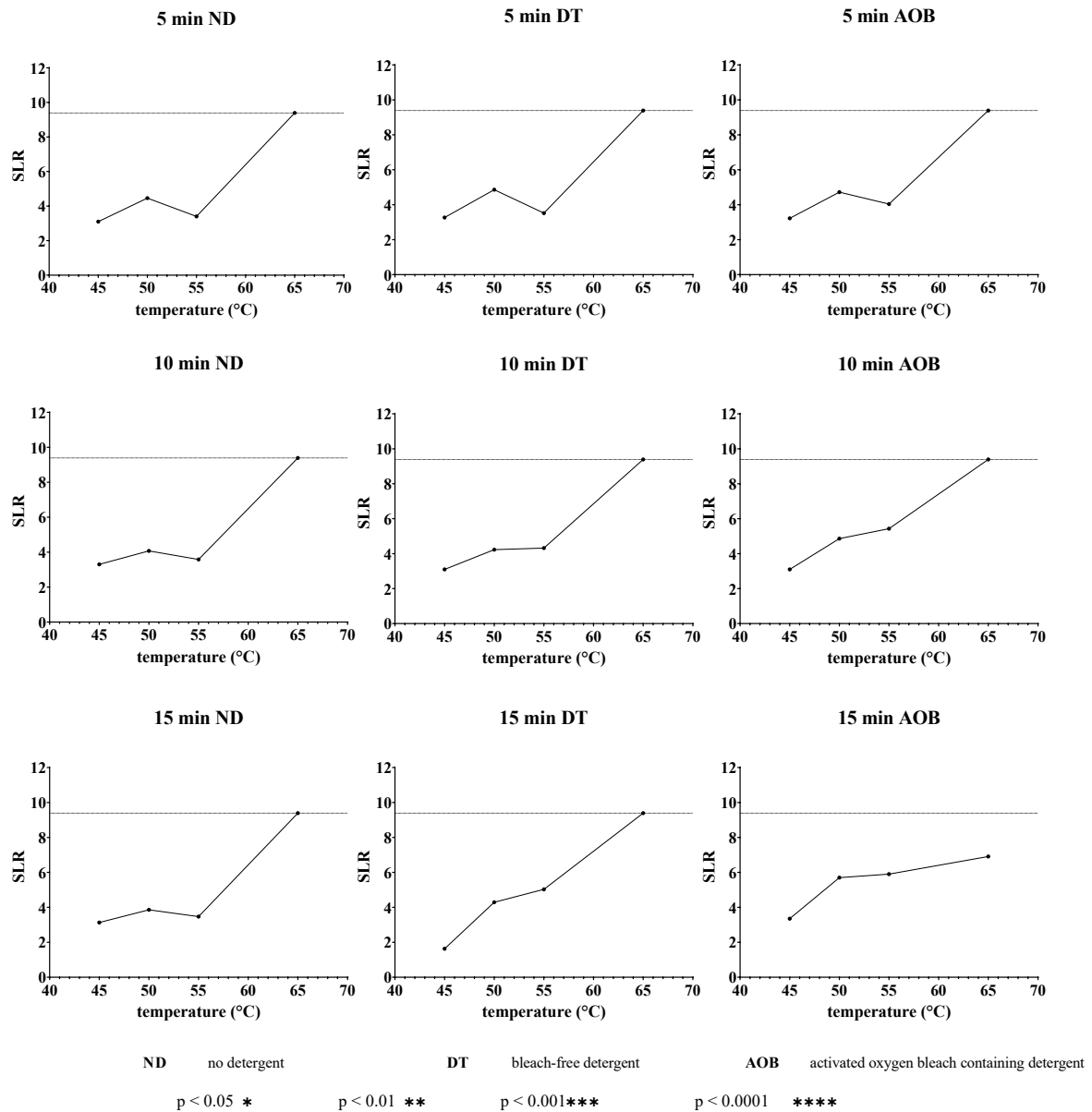

**Figure 22: Overview of the standardized logarithmic reductions of *M. luteus* DSM 1790 in the water. The dotted lines indicate the maximum SLR. No standard deviations or significances are given due to the small sample size.**

The comparisons for *S. aureus* DSM 939 are given in Figure 23 for the biomonitors. Here, the picture is a bit more complex than with *Ent. faecium* DSM 2146 or *M. luteus* DSM 1790. On the biomonitors, the increase of the temperature from 45 °C to 50 °C or 55 °C led to a significant decrease of the reduction in tests with a duration of 15 min without added detergent. When detergent of either type was added to the test, the reduction was significantly increased.

Temperature increases from 45 °C to 60 °C and 65 °C led to significantly increased reductions in all tests with durations of 5 min or 10 min and at 60 °C in the 15 min tests with either type of detergent added. Temperature changes from 50 °C to 55 °C significantly increased the reductions in the 10 min tests and the 5 min test with bleach-containing detergent. Changes from 50 °C to 60 °C did significantly increase the reductions in tests without detergent and in the tests with bleach-free detergent and durations of 5 min and 10 min. The increase of the temperature from 50 °C to 65 °C gave significantly different values in all tests with the reductions in the 15 min tests with either type of detergent giving significantly lower reductions. For temperature increases from 55 °C to either 60 °C or 65 °C, the reductions in all tests without detergent and the 5 min tests with either type of were significantly increased. At a temperature of 65 °C, the reductions in tests with either type of detergent and a duration of 15 min were significantly decreased. The temperature increase from 60 °C to 65 °C led to significantly decreased reductions in the 15 min tests.

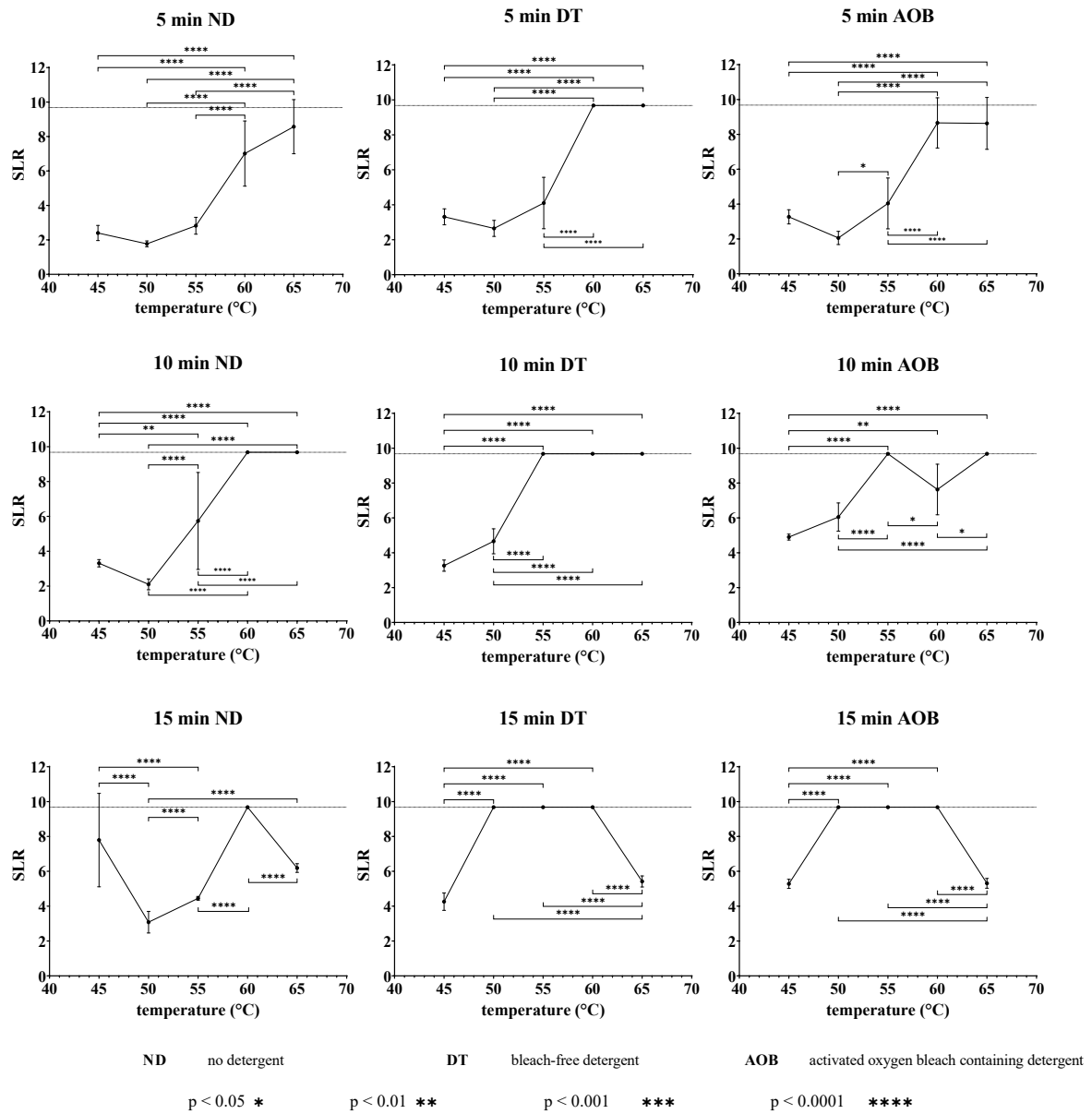

**Figure 23: Overview of the standardized logarithmic reductions of *S. aureus* DSM 939 on biomonitors. The dotted lines indicate the maximum SLR. Statistically significant differences in SLRs between different temperatures are marked with asterisks.**

In the water (Figure 24), the reduction of *S. aureus* DSM 939 does increase with rising temperatures in tests without detergent or with bleach-free detergent. In all tests, the reductions does reach a complete reduction at some point, depending on the duration, the temperature and the detergent used.

Interestingly, the reductions in tests with activated oxygen bleach containing detergent, a duration of 5 min and a temperature of 45 °C are higher than at 50 °C and higher than in the test with a duration of 10 min with the same temperature. This will be discussed later.

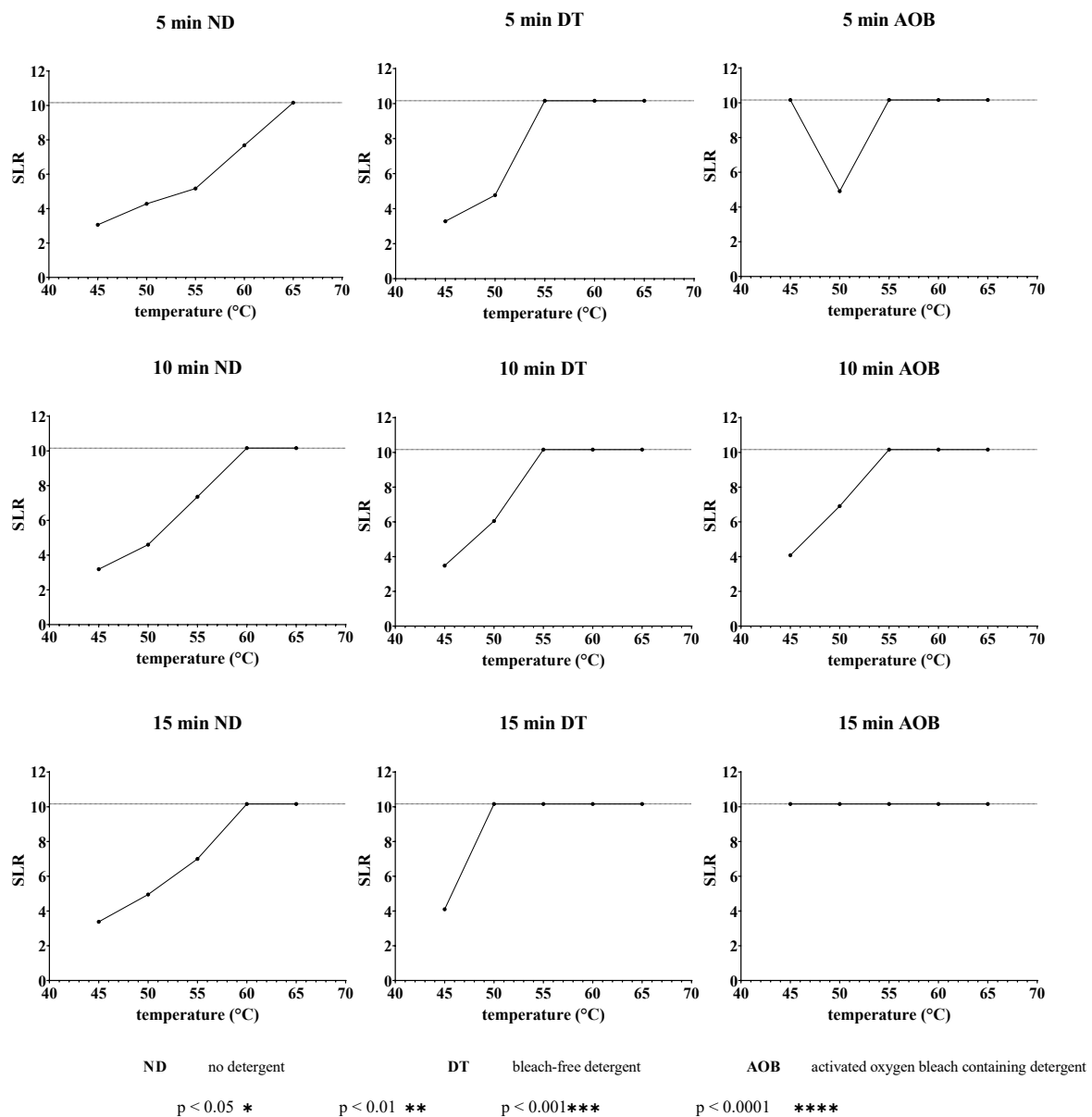

**Figure 24: Overview of the standardized logarithmic reductions of *S. aureus* DSM 939 in the water. The dotted lines indicate the maximum SLR. No standard deviations or significances are given due to the small sample size.**



### 4.3.2. Detergent

The influence of the detergent was investigated on the biomonitors as well in the water for the three test strains *Ent. faecium* DSM 2146, *M. luteus* DSM 1790 and *S. aureus* DSM 939. The results are given for *Ent. faecium* DSM 2146 (Figure 25 and Figure 26), *M. luteus* DSM 1790 (Figure 27 and Figure 28) and for *S. aureus* DSM 939 (Figure 29 and Figure 30). All figures are included in full size in Appendix: Full size figures.

When in 15 min tests at 45 °C activated oxygen bleach-containing detergent is used instead of either bleach-free detergent or no detergent, the SLR on the biomonitors increases significantly. In tests at 55 °C with a duration of 5 min, the addition of activated oxygen bleach-containing detergent instead of no detergent or bleach-free detergent, surprisingly the SLR is significantly decreased. The same is found for tests at 65 °C with a duration of 10 min when activated oxygen bleach-containing detergent is used instead of no detergent. These findings will be discussed later.

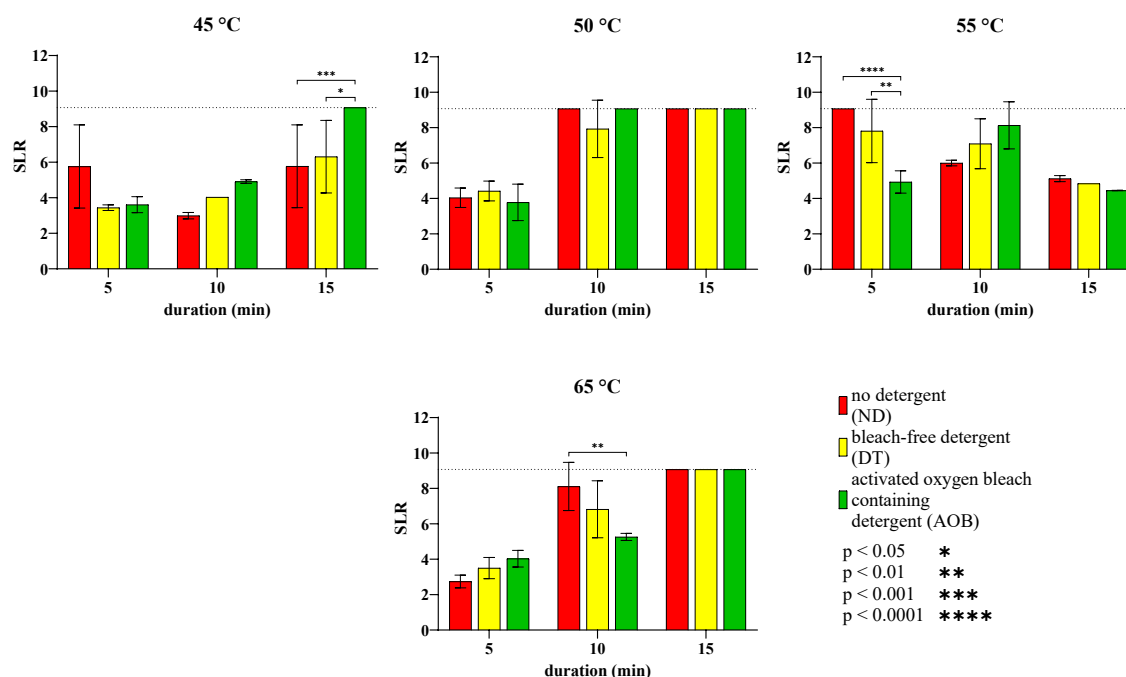

**Figure 25: SLR on biomonitors inoculated with *Ent. faecium* DSM 2146 after tests in the tergotometer with the given parameters. Statistically significant differences caused by a change in the detergent are marked with asterisks.**

The SLRs detected in the water (Figure 26) are increased in the 45 °C tests, when AOB-containing detergent is used instead of no detergent or bleach-free detergent. In tests with higher temperatures, no bacteria could be recovered from the water except for the 15 min test at 55 °C with activated oxygen bleach containing detergent. Why this single recovery was found with these test parameters, will be discussed later.

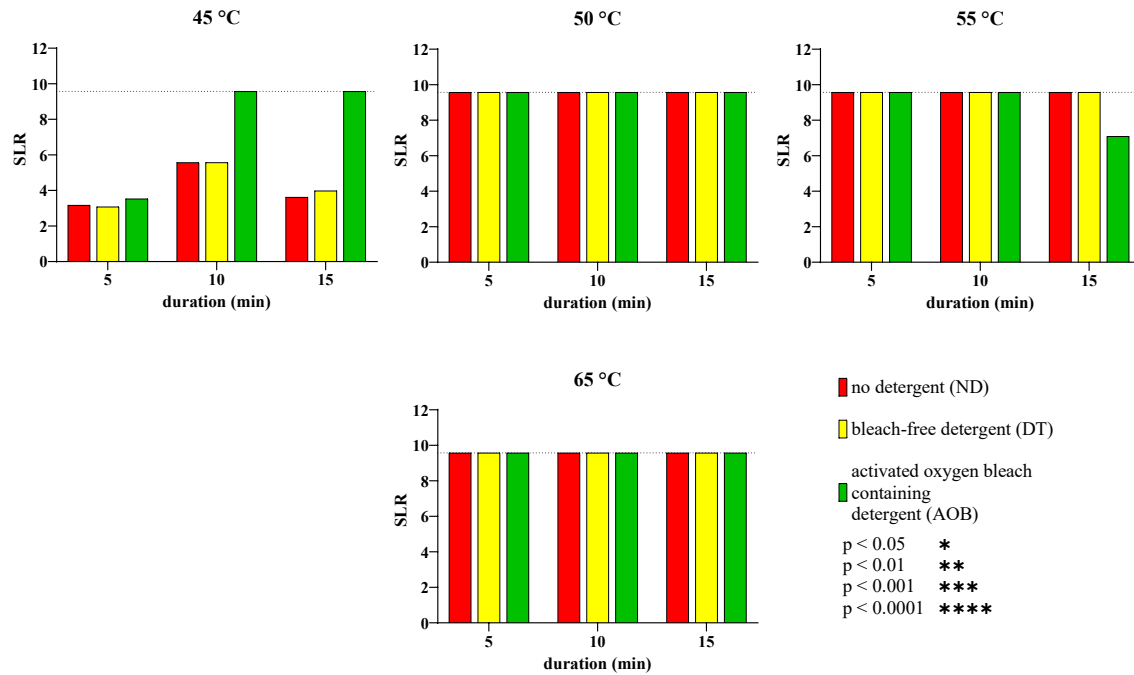

**Figure 26: Overview of the standardized logarithmic reductions (SLR) of *Ent. faecium* DSM 2146 in the water. The dotted lines indicate the maximum SLR. No standard deviations or significances are given due to the small sample size.**

In the tests with *M. luteus* DSM 1790 (Figure 27), the load on the biomonitors did increase significantly at a temperature of 50 °C and a test duration of 15 min, when AOB-containing detergent is used instead of no detergent. At a temperature of 65 °C and with a test duration of 5 min, the reduction increased significantly when bleach-free detergent is used instead of no detergent or AOB-containing detergent. Especially this last finding was unexpected.

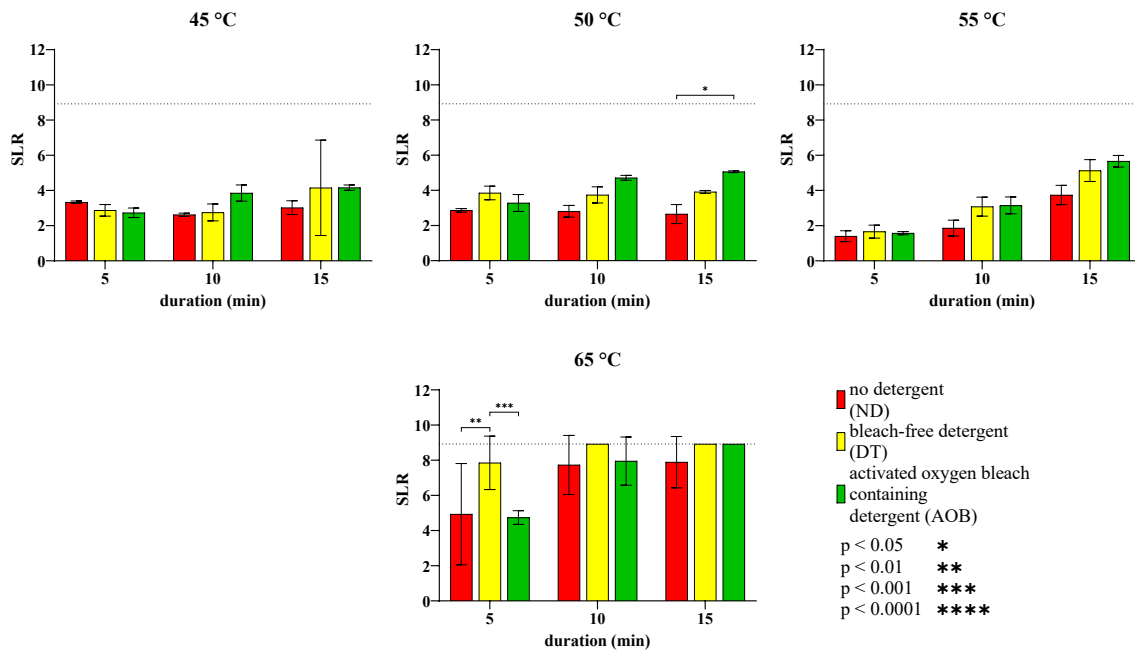

**Figure 27: SLR on biomonitors inoculated with biomonitors inoculated with *M. luteus* DSM 1790 after tests in the tergotometer with the given parameters. Statistically significant differences caused by a change in the detergent are marked with asterisks.**

When the SLRs of *M. luteus* DSM 1790 in the water are compared (Figure 28), clear differences between them can only be detected in tests with temperatures of 50 °C and 55 °C. Here, generally the use of bleach free detergent led to increased SLRs, which could be further increased with the addition of AOB-containing detergent.

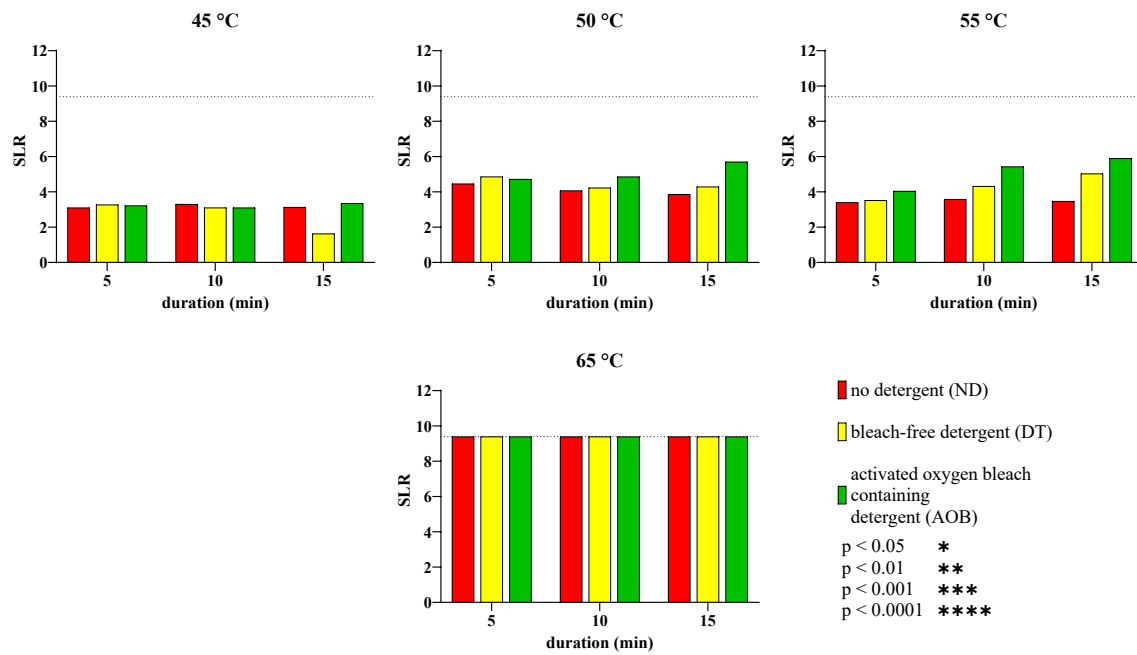

**Figure 28: Overview of the standardized logarithmic reductions (SLR) of *M. luteus* DSM 1790 in the water. The dotted lines indicate the maximum SLR. No standard deviations or significances are given due to the small sample size.**

The reductions on the biomonitors with *S. aureus* DSM 939 (Figure 29) did mainly show results that could be expected when Sinner's hypothesis is true. The use of detergent increases the SLR compared to tests without detergent and the use of AOB-containing detergent increases the SLR further. Additional to that, some rather unexpected findings were observed. In tests with a temperature of 45 °C and a duration of 15 min, the SLR significantly decreased when either type of detergent was used. Lower SLRs with AOB-containing detergent compared to bleach-free detergent were also observed in tests with a temperature of 60 °C. However, these were not significantly lower.

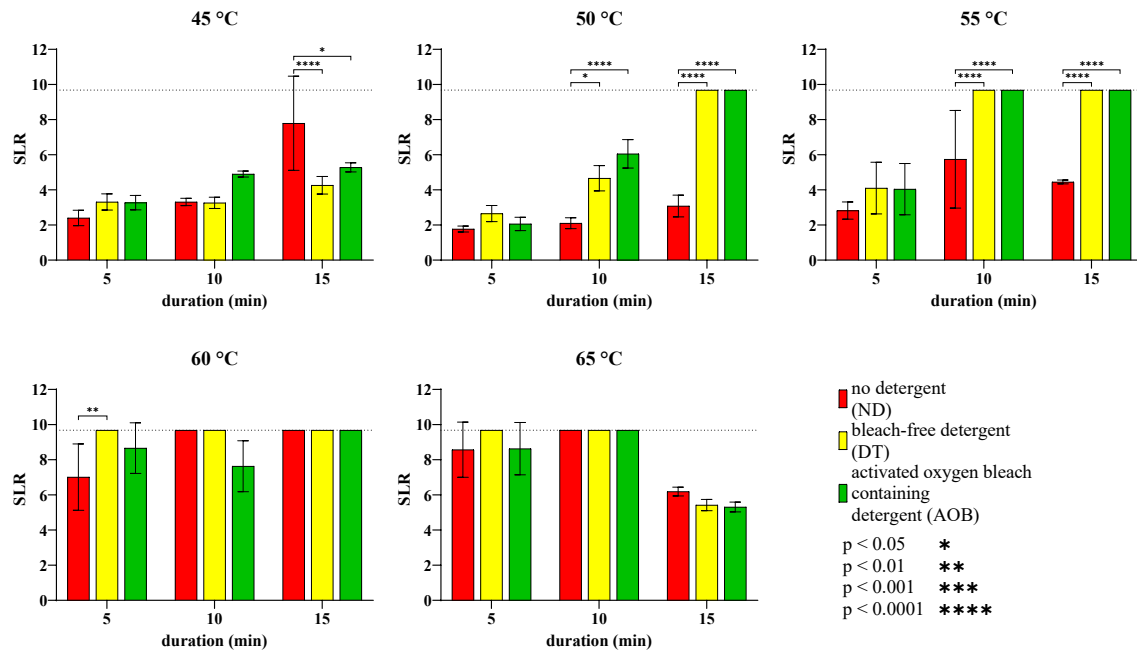
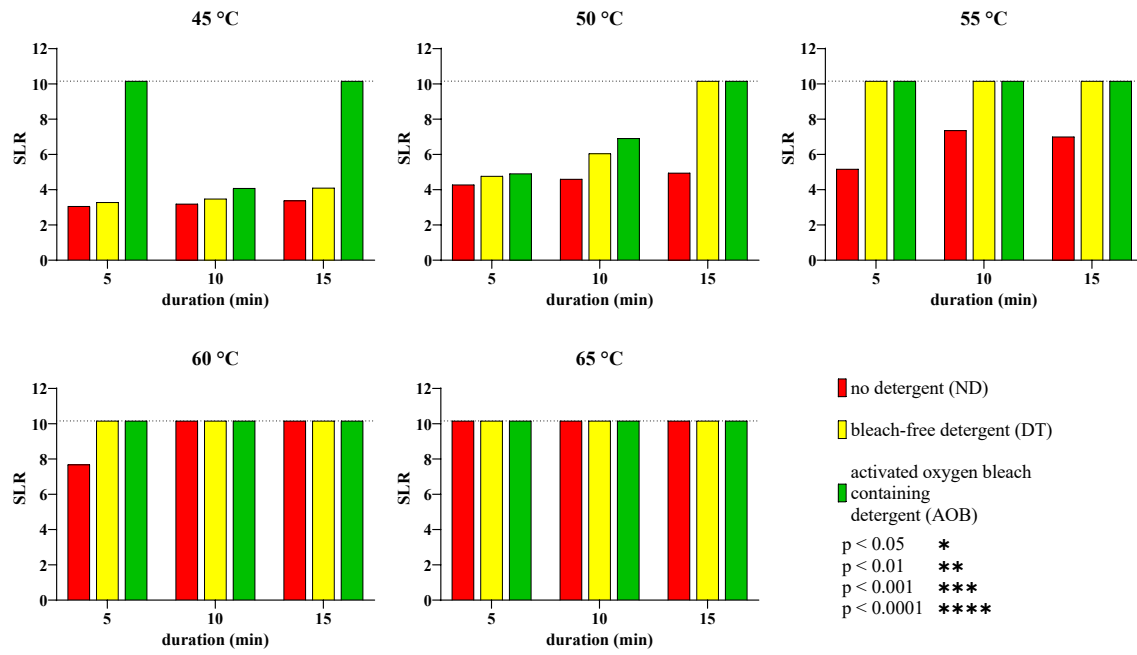

**Figure 29: SLR on biomonitors inoculated with *S. aureus* DSM 939 after tests in the tergotometer with the given parameters. Statistically significant differences caused by a change in the detergent are marked with asterisks.**

When the SLRs in the water are compared (Figure 30), no differences between bleach-free and AOB-containing detergent could be observed in tests with temperatures of 55 °C and above, as both detergents led to maximum SLRs. In contrast, in tests with a temperature of 55 °C and in the shortest tests with 60 °C, there is a clear difference between tests without detergent and with either type of detergent.

In the 50 °C tests, the SLR gradually increases when bleach-free detergent is used instead of no detergent and further increases when AOB-containing detergent is used in as well the 5 min as the 10 min tests. In the 15 min tests, the SLR is lower without detergent and reaches the maximum SLR with either detergent type.

The tests with 45 °C show a rather special result as the SLR in the 5 min tests with AOB-containing detergent reaches the maximum SLR while this is not the case in tests with a duration of 10 min. Here, there is a slight increase from no detergent to bleach-free detergent and another slight increase to AOB-containing detergent.

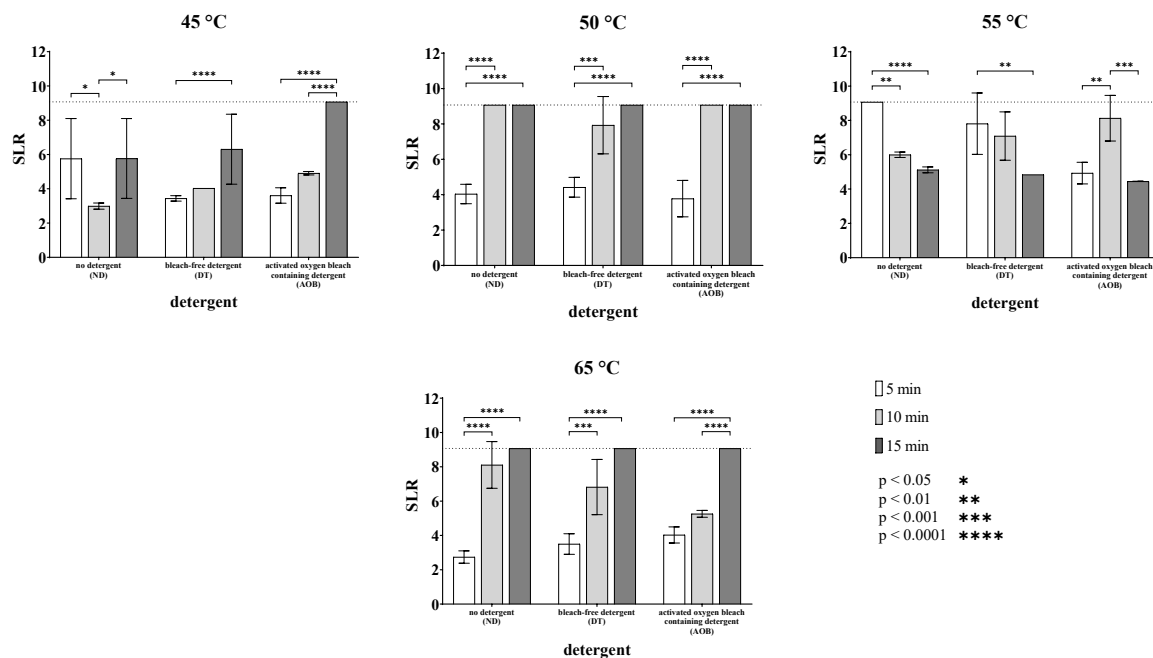

**Figure 30: Overview of the standardized logarithmic reductions (SLR) of *S. aureus* DSM 939 in the water. The dotted lines indicate the maximum SLR. No standard deviations or significances are given due to the small sample size.**

### 4.3.3. Duration

All figures of this section are included in full-size in Appendix: Full size figures.

The SLR on the biomonitors (Figure 31) of *Ent. faecium* DSM 2146 generally increases when the test duration was increased as can be expected based on Sinner's hypothesis. There are a few objections to this however, which is unexpected. For example, in tests without detergent and a temperature of 45 °C, the SLR was lowest with a duration of 10 min. Additionally, in tests with either bleach-free detergent or without detergent and a temperature of 55 °C, the SLR decreased with increasing duration, being significantly lowest in the longest tests. Possible reasons for the accumulation of these unexpected observations in the tests with a temperature of 55 °C will be discussed later.



**Figure 31: Overview of SLR on biomonitors inoculated with *Ent. faecium* DSM 2146 after tests in the tergotometer with the given parameters. Statistically significant differences caused by a change in the duration are marked with asterisks.**

The SLRs in the water (Figure 32) only reveal observable differences in the 45 °C tests and tests with a temperature of 55 °C and AOB-containing detergent. The latter was unexpected as the test with the longest duration shows the lowest SLR and thus contradicts Sinner's hypothesis. In the 45 °C tests without detergent or with bleach-free detergent, the SLR is highest in the 10 min tests, while due to Sinner's hypothesis this would be expected to be the case in the 15 min tests.

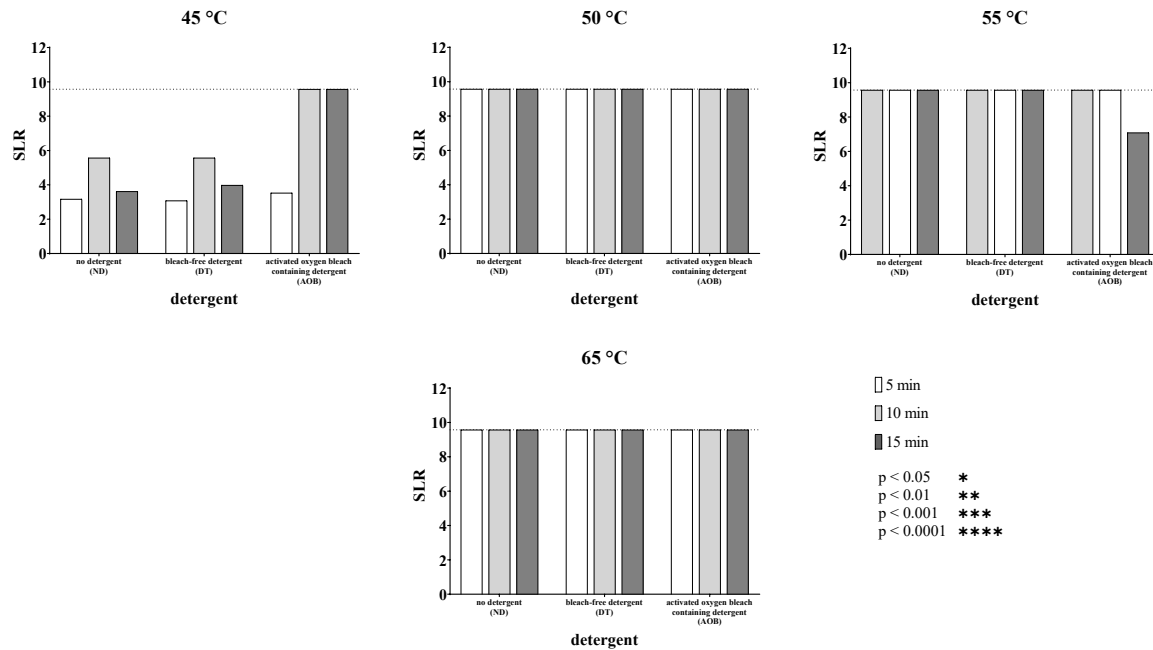

**Figure 32: Overview of the SLR of *Ent. faecium* DSM 2146 in the water. The dotted lines indicate the maximum SLR. No standard deviations or significances are given due to the small sample size.**

In the tests with *M. luteus* DSM 1790 (Figure 33), statistically significant increases of the reduction were detected in tests with a temperature of 55 °C with all detergent types including no detergent when the duration was increased from 5 min to 15 min and in the tests with AOB-containing detergent with a duration-increase from 10 min to 15 min. At a test temperature of 65 °C, an increase of the duration from 5 min to 10 min or 5 min to 15 min significantly increased the SLR in tests without detergent or with AOB-containing detergent.



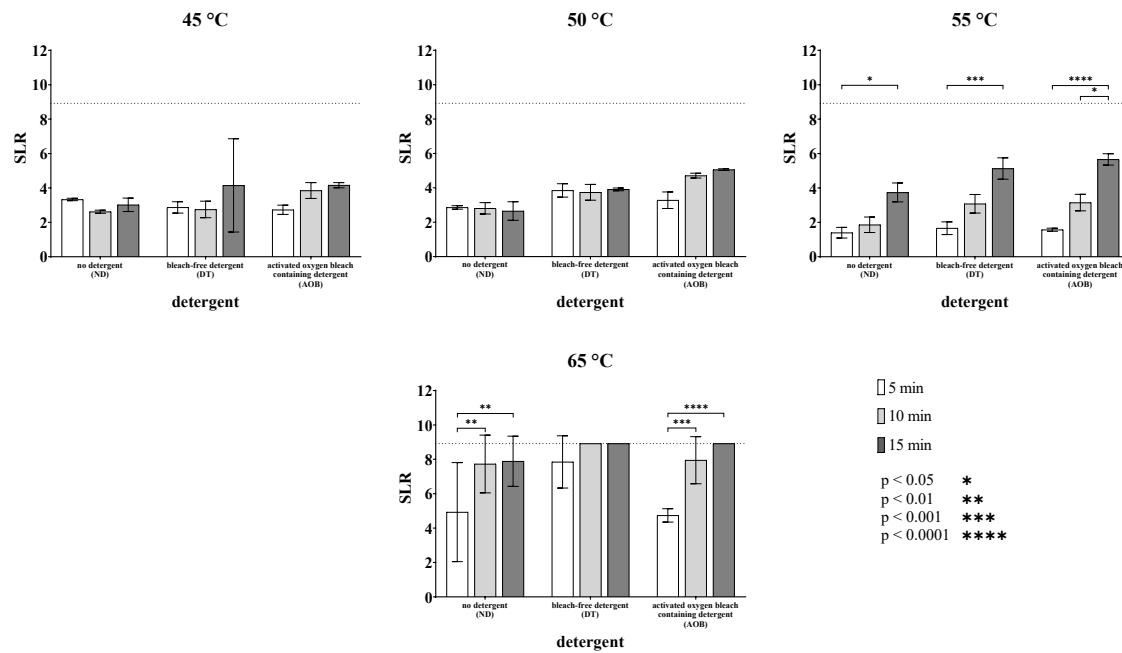

**Figure 33: Overview of SLR on biomonitors inoculated with *M. luteus* DSM 1790 after tests in the tergotometer with the given parameters. Statistically significant differences caused by a change in the duration are marked with asterisks.**

The SLRs in the water (Figure 34) generally did not show differences between the different durations in the 45 °C, 50 °C and 65 °C tests. This is also true for the tests without detergent and a temperature of 55 °C, while the tests with either type of detergent showed increased SLRs with increased duration. The only remarkable observation was made in tests with bleach-free detergent and a temperature of 45 °C where the SLR was lowest with the longest test duration.

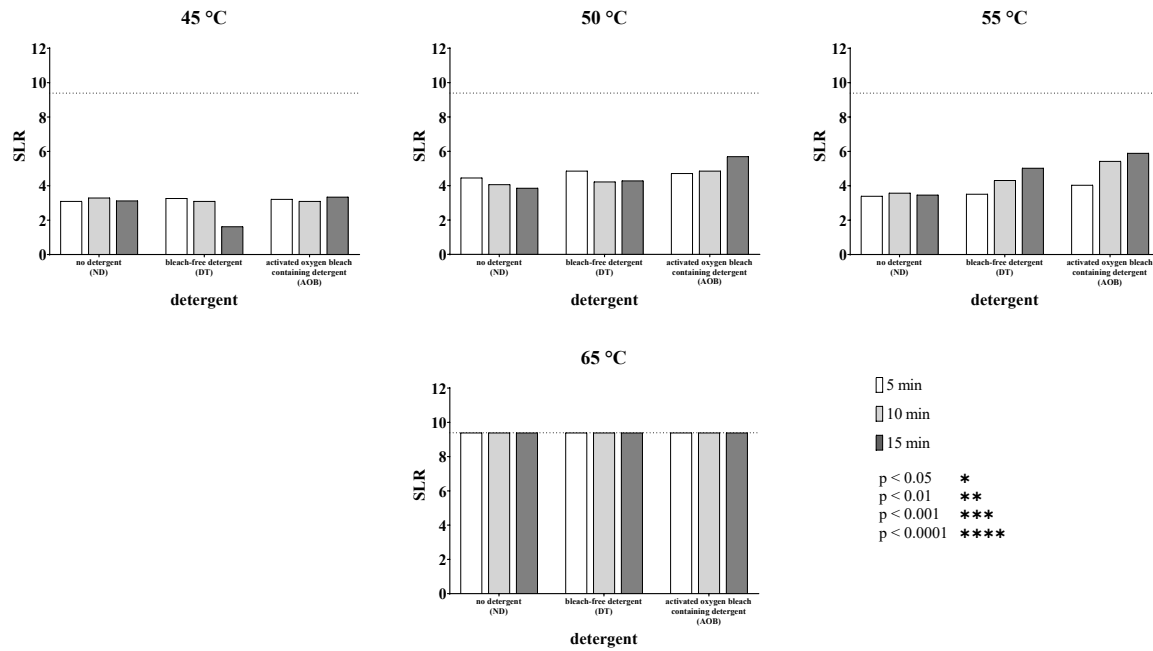
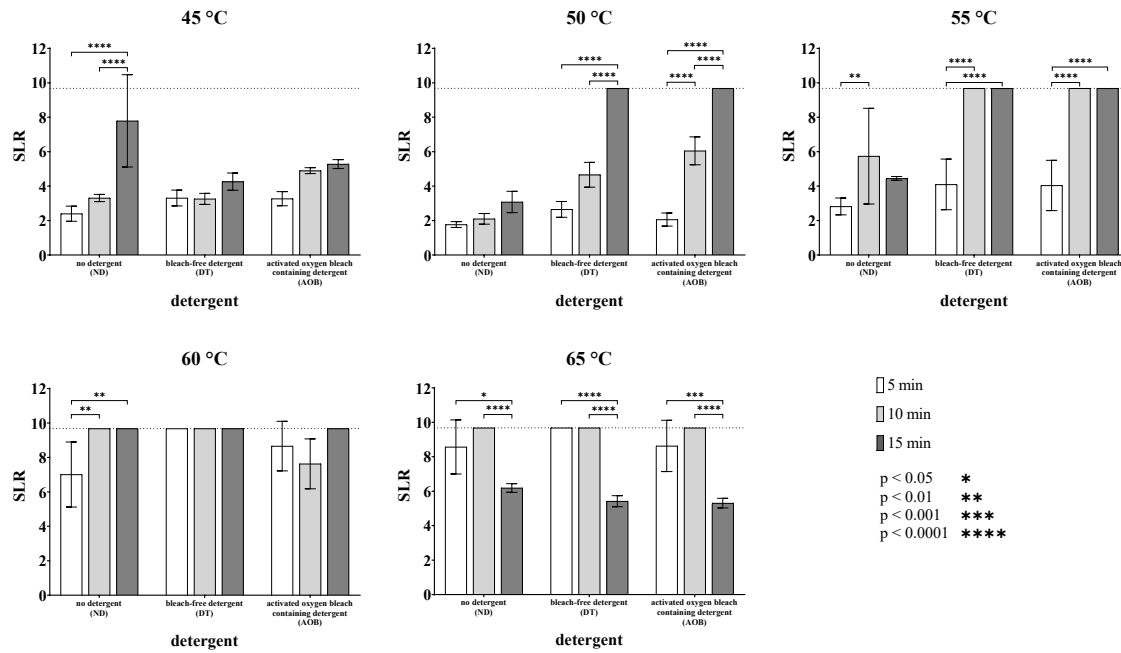

**Figure 34: Overview of the SLR of *M. luteus* DSM 1790 in the water. The dotted lines indicate the maximum SLR. No standard deviations or significances are given due to the small sample size.**

Last, the influence of changes in the test duration on the SLR of *S. aureus* DSM 939 was examined (Figure 35). With a water temperature of 45 °C, statistically significant increases in the SLR were detected in tests without detergent with duration increases from 5 min to 15 min and 10 min to 15 min. With a test temperature of 50 °C, a prolongation of the duration led to significantly increased SLRs in tests with either bleach-free or AOB-containing detergent.

The test temperature of 55 °C showed increased reductions with all tested detergent types including no detergent when the duration was increased from 5 min to 10 min. Additionally, increases from 5 min to 15 min led to significant increases of the SLR in tests with bleach-free and AOB-containing detergent.

In the tests at 65 °C, the SLR was unexpectedly lowest with durations of 15 min independent of the detergent used.



**Figure 35: Overview of SLR on biomonitors inoculated with *S. aureus* DSM 939 after tests in the tergotometer with the given parameters. Statistically significant differences caused by a change in the duration are marked with asterisks.**

When the SLRs in the water are examined (Figure 36), the observed SLRs in all tests from 50 °C to 65 °C showed equal (maximum reductions were achieved) or increasing reductions with longer durations. In the 45 °C tests, the low reduction in tests with AOB-containing detergent with durations of 10 min was unexpected. This will be addressed later.

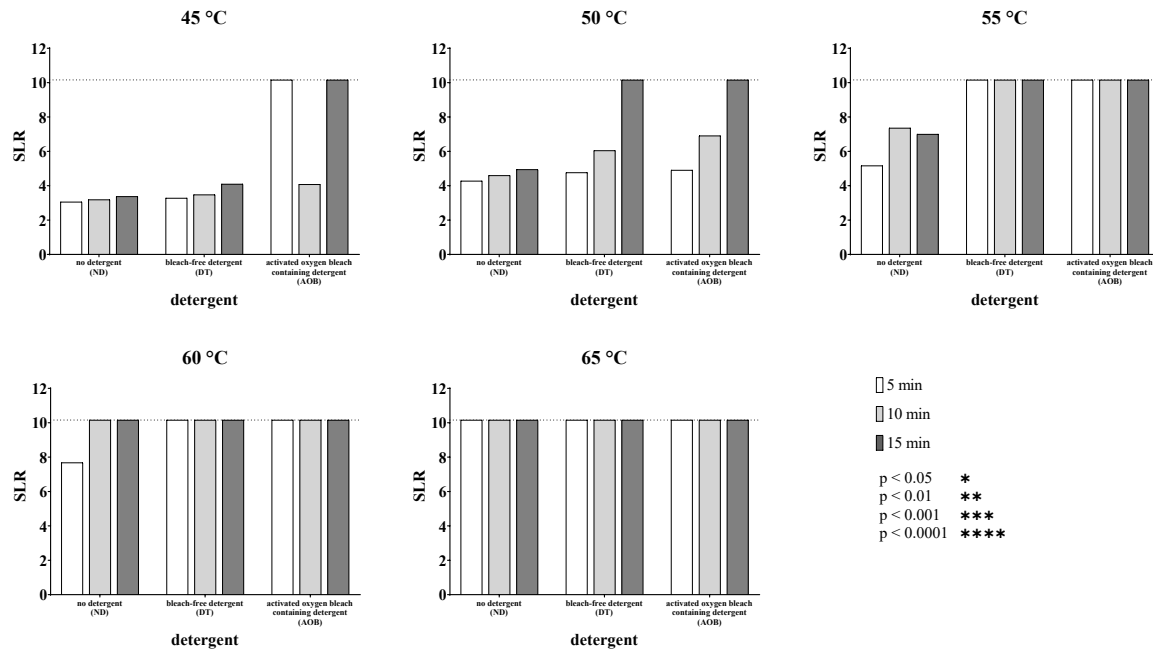

**Figure 36: Overview of the SLR of *S. aureus* DSM 939 in the water. The dotted lines indicate the maximum SLR. No standard deviations or significances are given due to the small sample size.**

#### 4.3.4. Mechanical action

All tests in the tergotometer were carried out using the same mechanical action of 50 rpm. For this reason, the influence of the mechanical action on the LR cannot be analysed in this setting.

#### 4.4. Influence factors in household dishwashers

After the tests in the tergotometer have revealed the influence of different factors under closely regulated conditions in the tergotometer and the influence of the mechanical action has been shown in the handwashing experiments, the focus is now on the cleaning cycles in the automated dishwasher for household use.

The initial count on the biomonitors of *Ent. faecium* DSM 2146 fluctuated between  $1 \times 10^7$  cfu · mL<sup>-1</sup> and  $4 \times 10^9$  cfu · mL<sup>-1</sup>, those of *M. luteus* DSM 1790 between  $1.4 \times 10^8$  cfu · mL<sup>-1</sup> and  $5.6 \times 10^9$  cfu · mL<sup>-1</sup>. As described before, these values were standardized and the maximum SLR was set to nine.

In the tests with *Ent. faecium* DSM 2146 (Figure 37) with a cleaning duration of 5 min, the SLR in tests without detergent was determined to be between 5.9 at 50 °C and 8 at 65 °C. In the comparable test setting with bleach-free detergent, the SLR was between 7.5 at the lowest test temperatures of 45 °C and 50 °C, then showed an increase to a SLR of 8.7 at a cleaning temperature of 60 °C and reached total reduction of the microbial count at the two highest cleaning temperatures. With AOB-containing detergent, the reductions at the lower cleaning temperatures were around 6.5 with a higher SLR at the lowest cleaning temperature, then gradually rose and reached a maximum of 8.5 at the highest cleaning temperature of 75 °C.

When a test duration of 10 min was used, the SLRs in the tests cycles without detergent were between 6 (45 °C) and 8.8 (75 °C). When bleach-free detergent was used the SLR at 45 °C, was higher with a mean value of 8.74 and with tests temperatures of 60 °C and above, the maximum SLR was reached. The values with AOB-containing detergent were between 5 (at 45 °C) and 8.5 (at 75 °C).

Test durations of 15 min without detergent resulted in SLRs of 5.1 at 45 °C, remaining rather constant up to test temperatures of 60 °C with a SLR of 5.7, then showed an increase to 7.13 and reached 7.64 at 75 °C. When bleach-free detergent was used in the test with the same cleaning duration, the SLRs were between 5.9 at 45 °C and 6.2 at 50 °C, and around the maximum SLR of 9 with all higher cleaning temperatures. When AOB-containing detergent was used, the SLRs were around 6 for cleaning temperatures of 45 °C and 50 °C, then gradually increased to an SLR of 8.8 at 65 °C.

With cleaning durations of 45 min in tests without detergent, the SLR was 6.2 at 45 °C. With all higher cleaning temperatures, the maximum SLR of 9 was reached. When bleach-free detergent was used, the SLR was 9 at all cleaning temperatures. With AOB-containing

detergent, the SLR at a cleaning temperature of 45 °C was 5.8, then rose to 8.4 at 50 °C. At 55 °C and 60 °C, the maximum SLR of 9 was reached. At 65 °C the SLR was 8.3 and at 75 °C it was 8.7.

When cleaning durations of 90 min were used, the SLRs in tests without detergent were between 6.4 at 45 °C, then gradually rose, until they reached the maximum SLR of 9 at a cleaning temperature of 65 °C and above. When bleach-free detergent was used, the SLR of 9 was reached with all test temperatures. In tests with AOB-containing detergent, the SLR at 45 °C was 5.6 and at 65 °C it was 8.3. The remaining test temperatures showed SLRs of 9.

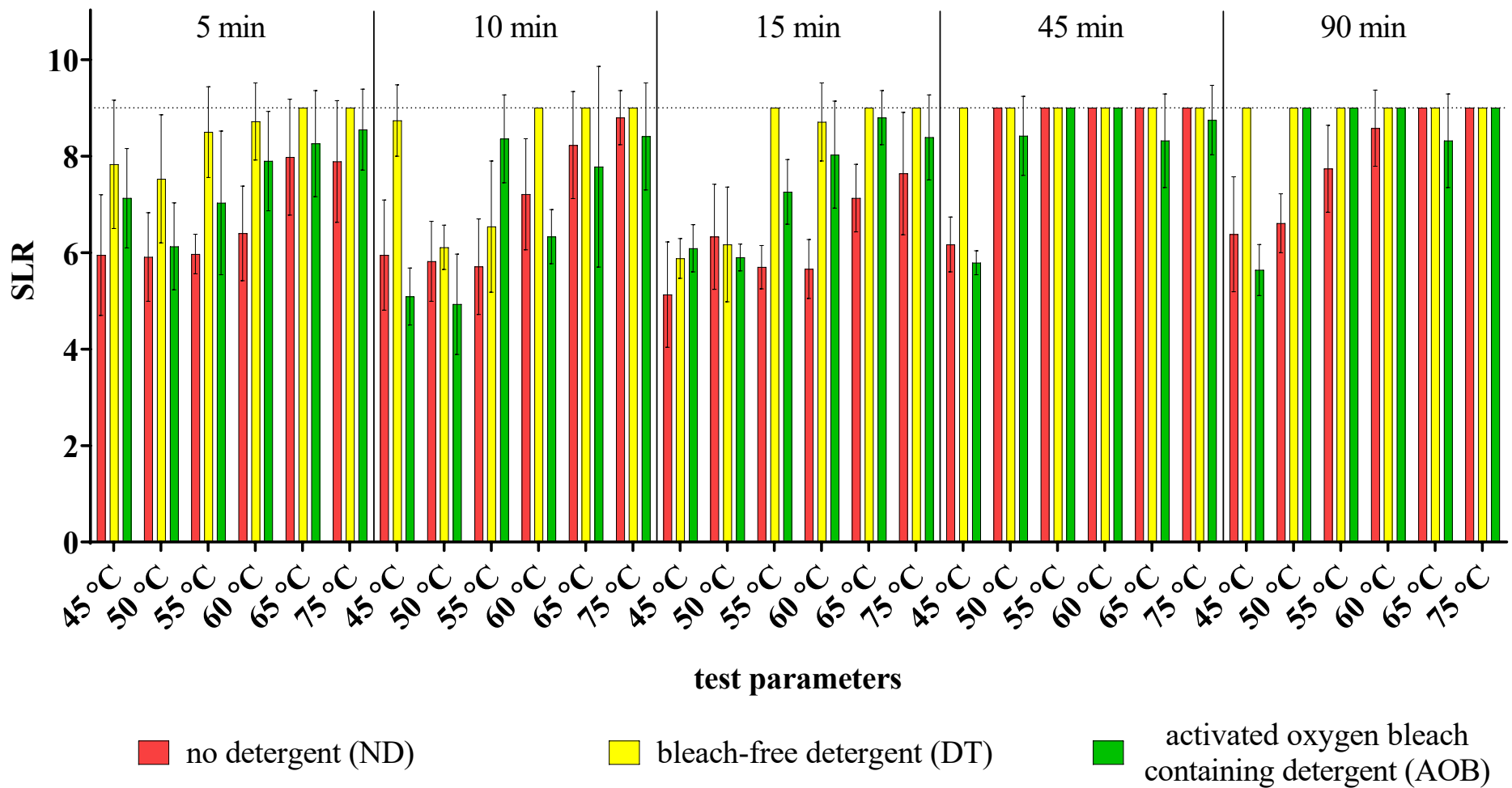

Figure 37: Standardized logarithmic reductions on biomonitors contaminated with *Ent. faecium* DSM 2146 after cleaning cycles with the given test parameters in the automated dishwasher. The dotted line indicates the maximum SLR. Each data point represents mean values of 9 biomonitors cleaned in 3 independent test cycles. Dashed lines represent the initial load of the biomonitors.

With *M. luteus* DSM 1790 (Figure 38) as test strain, the same tests have been performed.

In test cycles with a cleaning duration of 5 min without detergent, the SLRs were between 5 at 50 °C and 7.5 at 75 °C with a SLR of 6.5 at 45 °C. When bleach-free detergent was added to the test cycles, the SLRs were between 5 at 45 °C and 50 °C, then rose up to the maximum SLR of 9 at test temperatures of 65 °C and above. When AOB-containing detergent was used, the SLRs were between 6.3 at 50 °C and 8.1 at 60 °C and above. At 45 °C, the SLR was higher than with the temperature of 50 °C, reaching 7.8.

With a cleaning duration of 10 min, the SLRs in test cycles without detergent were between 6 at 60 °C and 8.6 at 75 °C. The SLRs varied with the lower cleaning temperatures, showing high standard deviations. In cycles with bleach-free detergent, the SLRs were between 5 at 45 °C, rising exponentially to a SLR of 8.76 at 65 °C and reaching a SLR of 9 at 75 °C. When AOB-containing detergent was used, the SLRs were between 6.5 at 45 °C, rising to 9 at 65 °C. The SLR at 60 °C was the lowest in this test series with a value of 6.1.

A cleaning duration of 15 min without detergent gave SLRs around 5 with temperatures from 45 °C to 65 °C, with an exception of the SLR at 50 °C, which was 5.6. With a test temperature of 75 °C, an SLR of 8 was reached. When bleach-free detergent was added to the tests, the SLRs rose slightly from 5.3 at 45 °C to 6.5 at 60 °C, followed by a steep increase to an SLR of 9 for the two highest cleaning temperatures. When AOB-containing detergent was used, the SLR was 6 at 45 °C, rose to 7 at 55 °C, reaching a value of 8 at 65 and 75 °C.

With a cleaning duration of 45 min, the SLR rose linearly from 6.5 at 45 °C to 8.5 at 60 °C in tests without detergent. The SLR remained between 8 and 8.5 for temperatures up to 65 °C, then reached an SLR of 9 equalling total reduction at 75 °C. When either bleach-free or AOB-containing detergent were added to the test cycles, total reduction were achieved from tests temperatures of 50 °C. In the tests with 45 °C, the SLR was 7.7 with bleach-free detergent and 5.6 with AOB-containing detergent.

In the longest tests with a cleaning duration of 90 min without detergent, the SLR was 5.3 at 45 °C, then rose to values about 8 up to a temperature of 65 °C and reached 9 at 75 °C. When bleach-free detergent was used, total reductions on the biomonitors were achieved with all test temperatures. When AOB-containing detergent was used, total reduction on the biomonitors was achieved in all tests with temperatures of 50 °C and above. The SLR for the test temperature of 45 °C was 6.9.



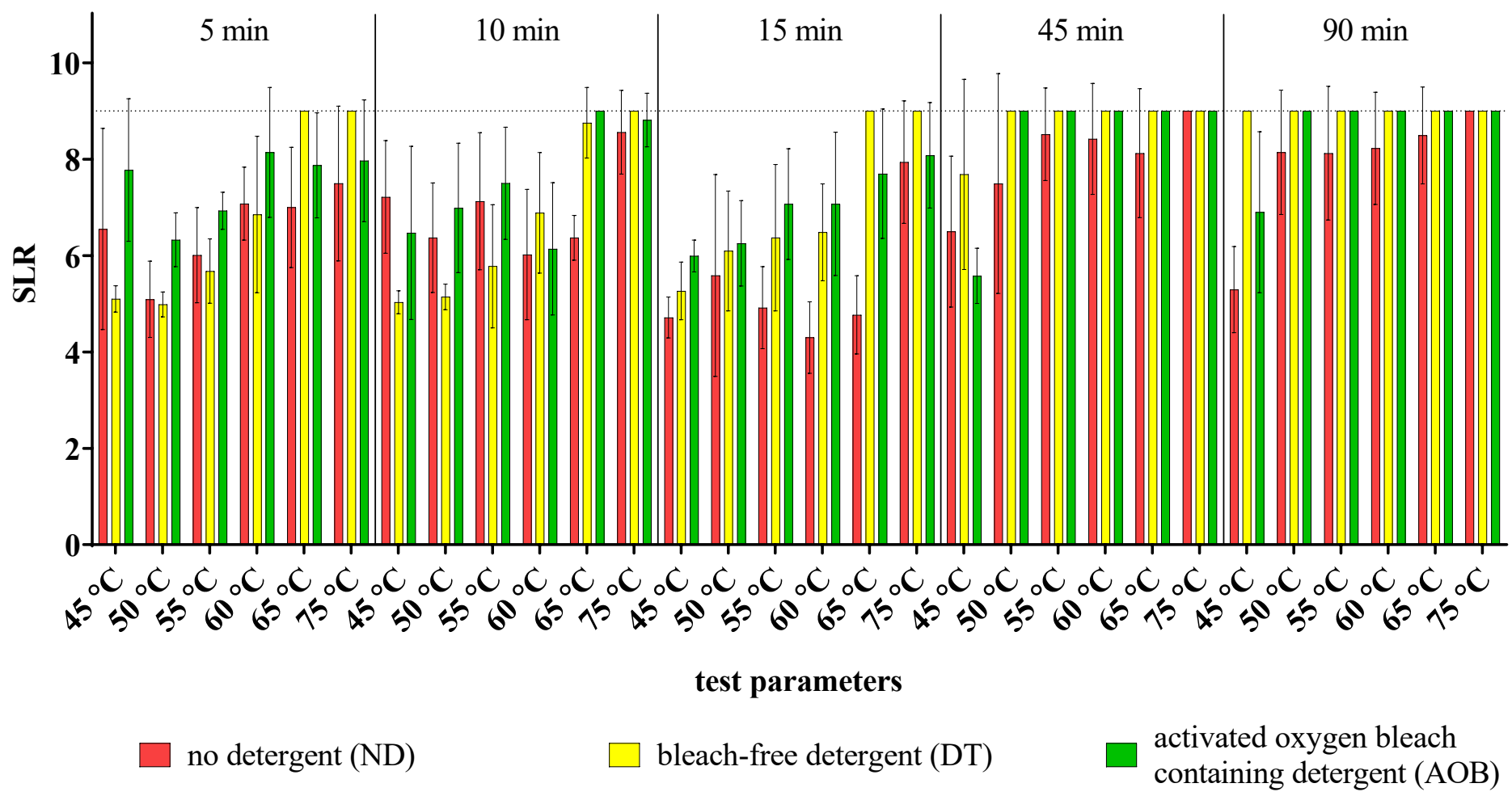

Figure 38: Standardized logarithmic reductions on biomonitors contaminated with *M. luteus* DSM 1790 after cleaning cycles with the given test parameters in the automated dishwasher. The dotted line indicates the maximum SLR. Each data point represents mean values of 9 biomonitors cleaned in 3 independent test cycles. Dashed lines represent the initial load of the biomonitors.

#### 4.4.1. Temperature

The influence of the cleaning temperature on the SLR was analysed for all tested cleaning durations. The results for each duration are given in separate figures for reasons of legibility.

The influence of the rinsing temperature was analysed using the strains *M. luteus* DSM 1790, *M. luteus* DSM 20030 and *M. luteus* DSM 28269. These tests have performed by Sarah Schulze Struchtrup at the Household and Appliance Technology Section during a joint project. Small figures from this section are included in full size in Appendix: Full size figures.

When the influence of the cleaning temperature was analysed for a duration of 5 min (Figure 39), the SLRs in test without detergent rise between temperatures of 55 °C and 65 °C, but remain rather constant with temperature changes below or above these values. When the SLRs are plotted as line chart, a sigmoidal curve becomes visible. The tests with bleach-free detergent show a similar picture but with the rise shifted towards lower temperatures. When activated oxygen bleach containing detergent is used, the SLRs obtained at the lowest temperature of 45 °C are a bit lower than at 50 °C, but both are within the same range when the standard deviation is taken into account.

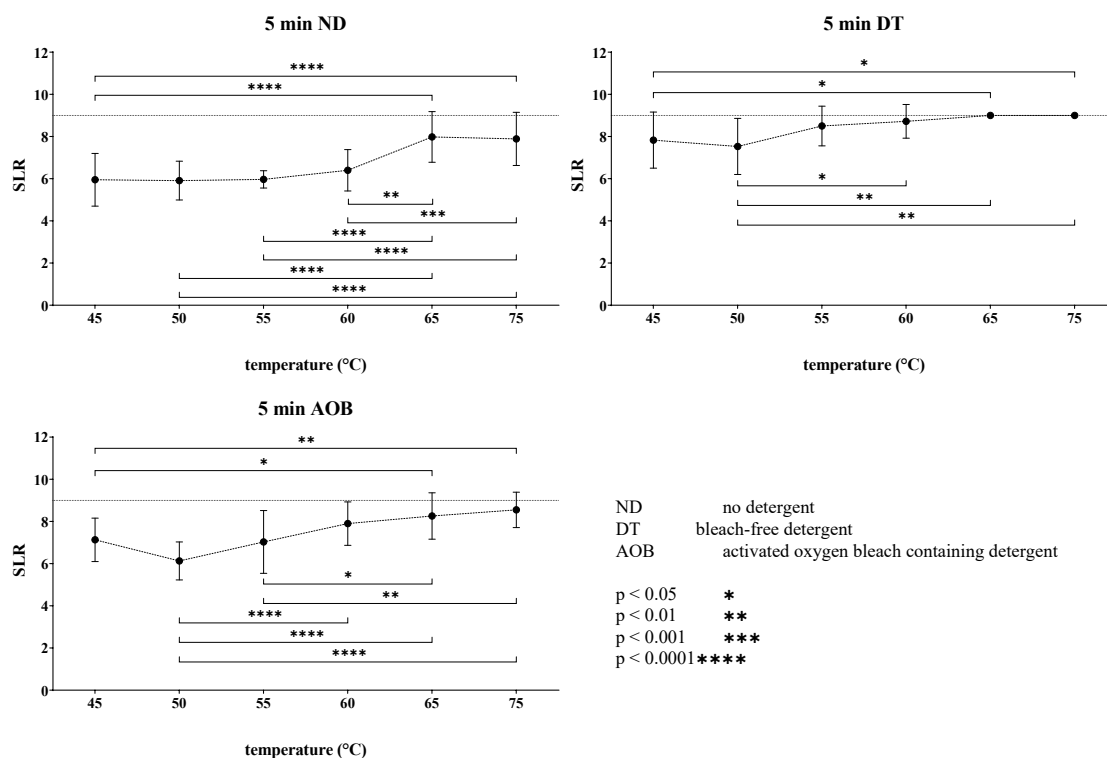
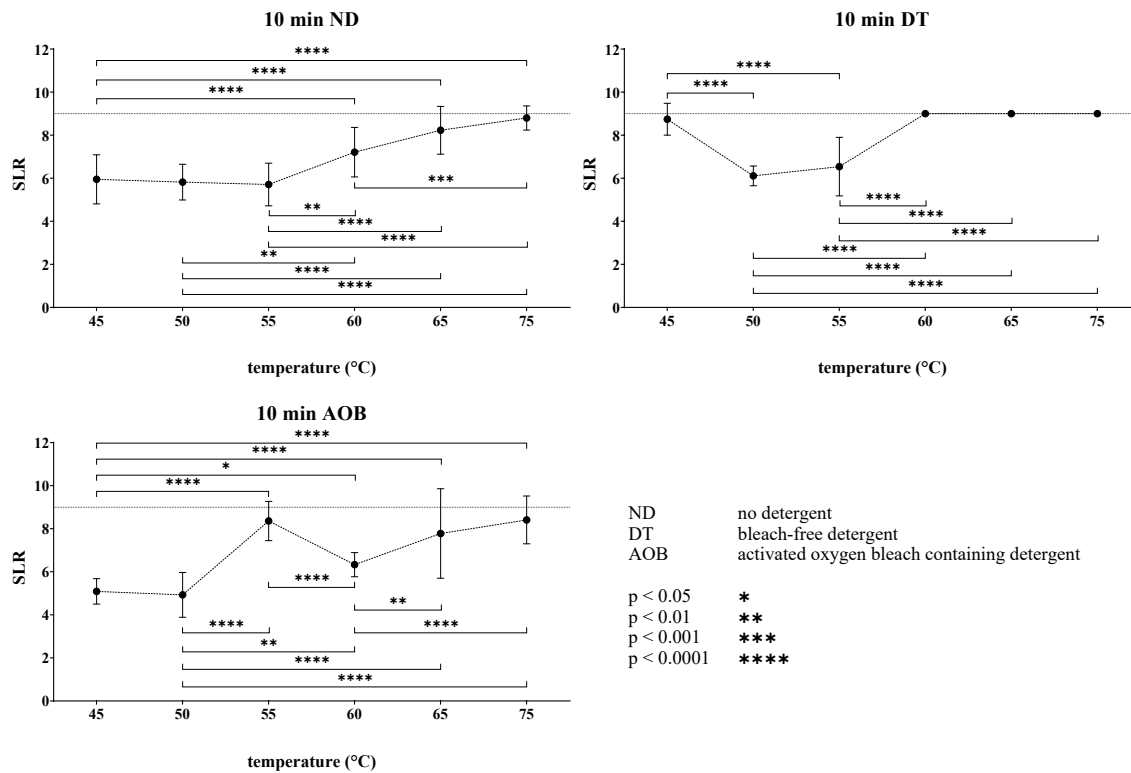

**Figure 39: Overview of the standardized logarithmic reductions (SLR) of *Ent. faecium* DSM 2146 on biomonitors used in tests with a duration of 5 min. Statistically significant differences caused by a change in the test temperature are marked with asterisks.**

The picture in tests cycles without detergent and durations of 10 min (Figure 40) is similar to the corresponding 5 min tests, but with a shift of the higher SLRs from 65 °C to 60 °C.

In tests with bleach-free detergent, the SLRs detected at 45 °C were unexpectedly high, especially when compared to the reductions achieved at 50 °C and 55 °C. Possible reasons for this finding will be discussed later.

When AOB-containing detergent was used in the 10 min tests, there was generally an increase of the SLR with rising temperature. Here, the higher SLR in tests with a temperature of 55 °C compared to the tests with a temperature of 60 °C was not to be expected. A very likely reason is found in the detergent in will be discussed in detail later.



**Figure 40: Overview of the standardized logarithmic reductions (SLR) of *Ent. faecium* DSM 2146 on biomonitors used in tests with a duration of 10 min. Statistically significant differences caused by a change in the test temperature are marked with asterisks.**

When test durations of 15 min were analysed (Figure 41), SLRs increased in the respective tests when the temperature was increased. The standard deviations were generally higher in the tests with the lowest temperatures.

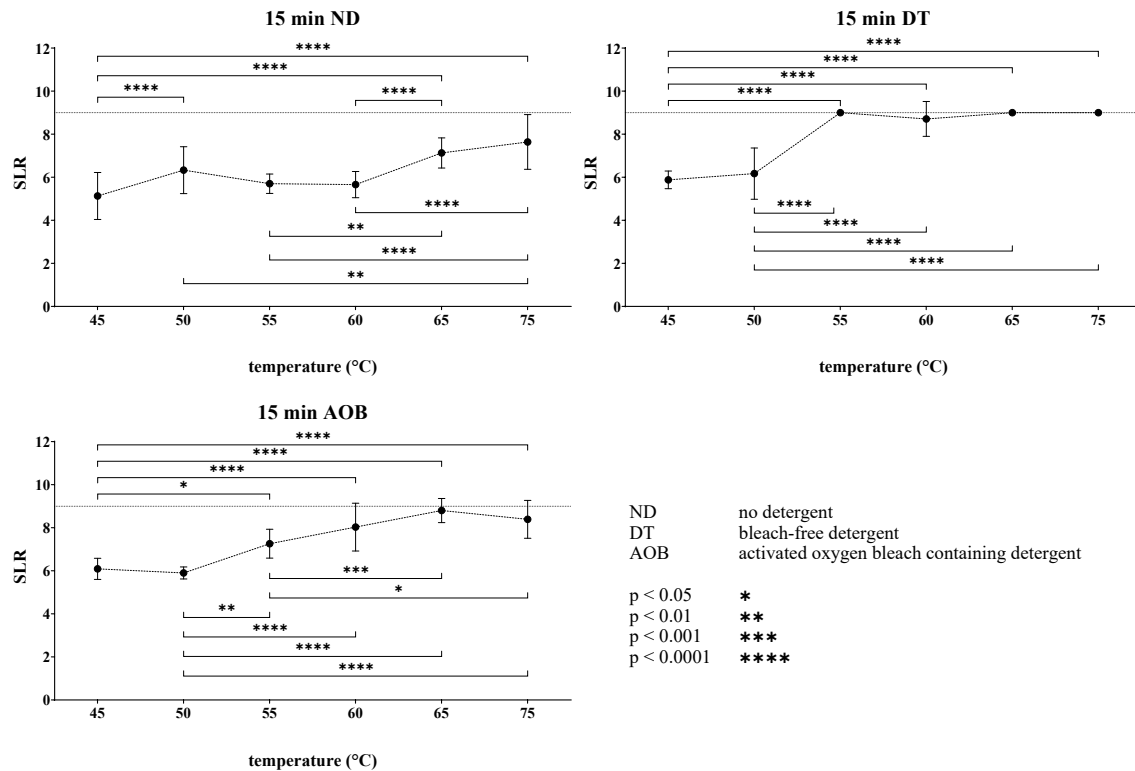

**Figure 41: Overview of the standardized logarithmic reductions (SLR) of *Ent. faecium* DSM 2146 on biomonitors used in tests with a duration of 15 min. Statistically significant differences caused by a change in the test temperature are marked with asterisks.**

In test with a cleaning duration of 45 min (Figure 42), the SLR reached the maximum in all tests with bleach-free detergent and in all tests without detergent except for those with the lowest test temperature. A lower SLR was also found in the tests with AOB-containing detergent at temperatures of 45 °C, 50 °C, 65 °C and 75 °C, with the latter three being close to the maximum SLR.

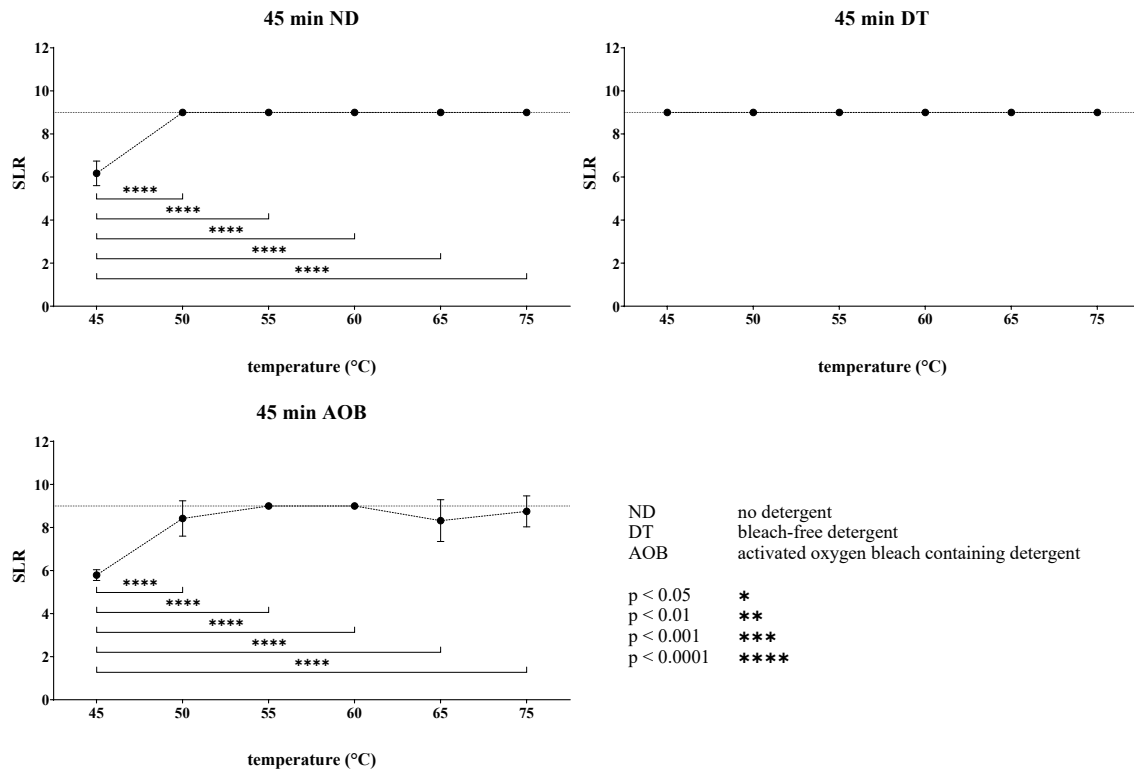
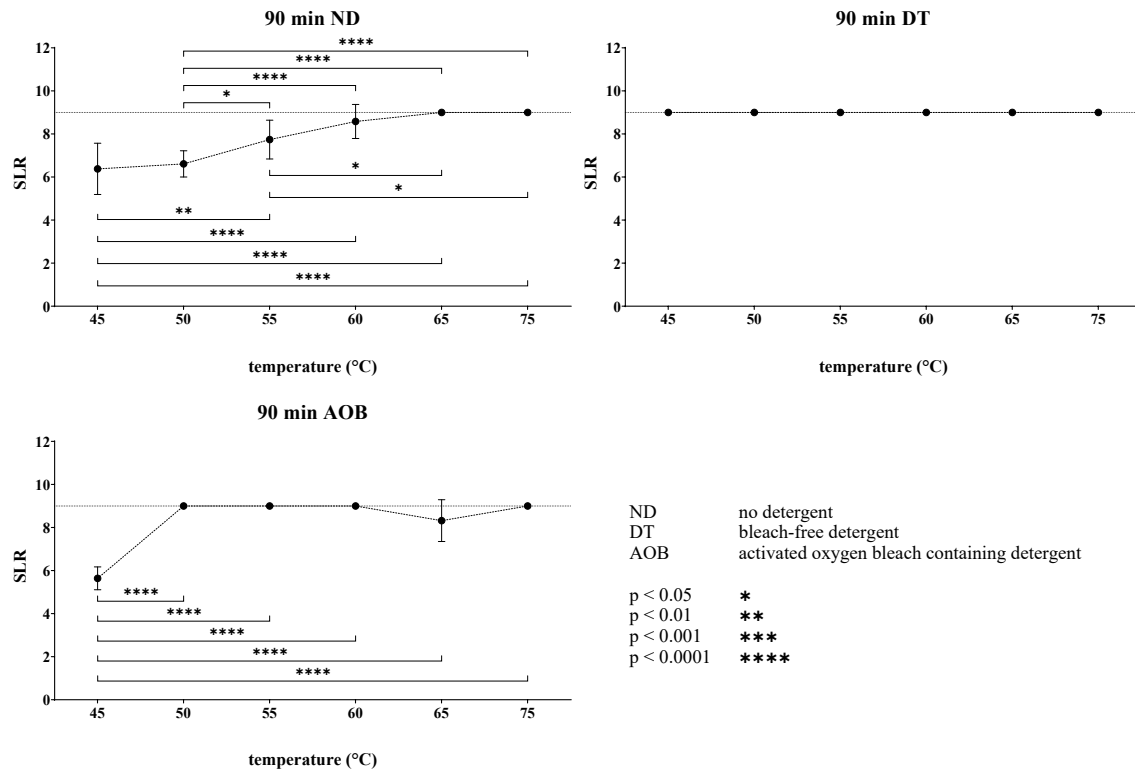

**Figure 42: Overview of the standardized logarithmic reductions (SLR) of *Ent. faecium* DSM 2146 on biomonitors used in tests with a duration of 45 min. Statistically significant differences caused by a change in the test temperature are marked with asterisks.**

When a cleaning duration of 90 min (Figure 43) was used, an increase of the test temperature gradually increased SLRs in tests without detergent. Above 65 °C, complete reduction was reached.

In tests with bleach free-detergent, all temperatures completely reduced the microbial load with a duration of 90 min.

When AOB-containing detergent was used, complete reduction was achieved with all tested temperatures of 50 °C and above.



**Figure 43: Overview of the standardized logarithmic reductions (SLR) of *Ent. faecium* DSM 2146 on biomonitors used in tests with a duration of 90 min. Statistically significant differences caused by a change in the test temperature are marked with asterisks.**

Next, the influence of the temperature changes in tests with *M. luteus* DSM 1790 was analysed.

When tests were performed with a duration of 5 min (Figure 44), The SLR in tests without detergent generally increased with rising temperature. An exception here is the SLR at 45 °C, which is significantly higher than the SLR at 50 °C. This same picture is also found in the test with AOB-containing detergent, but not in the tests with bleach-free detergent.

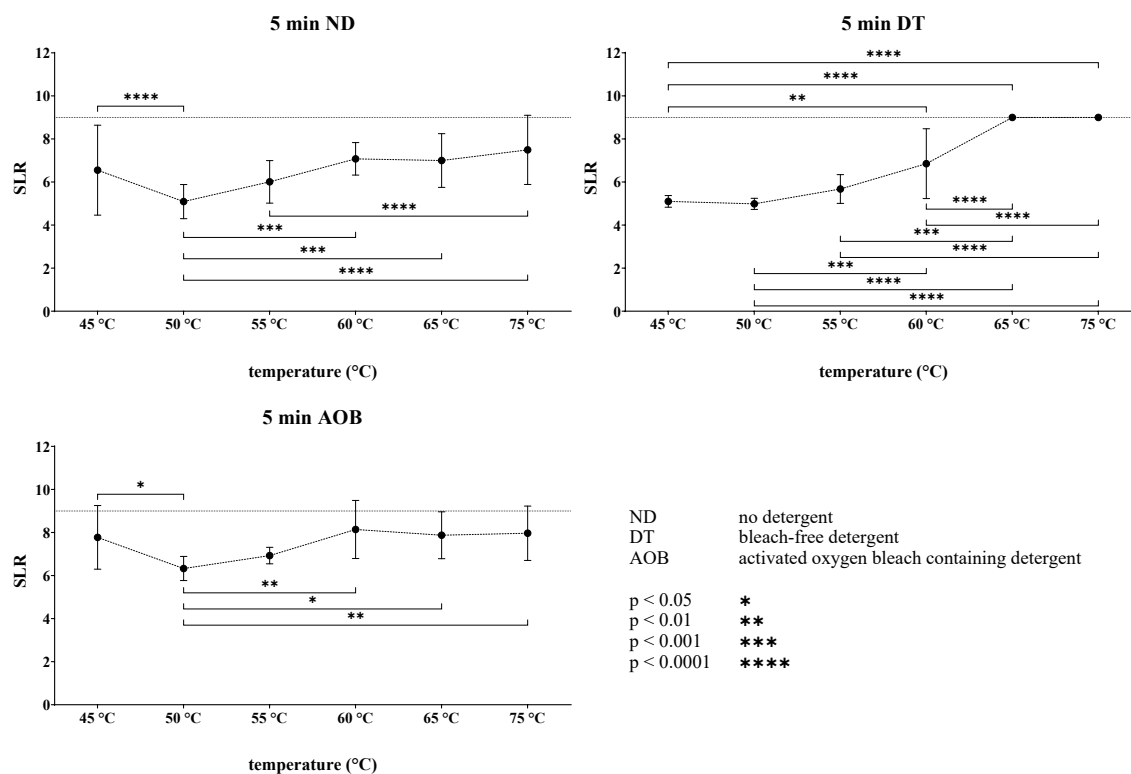
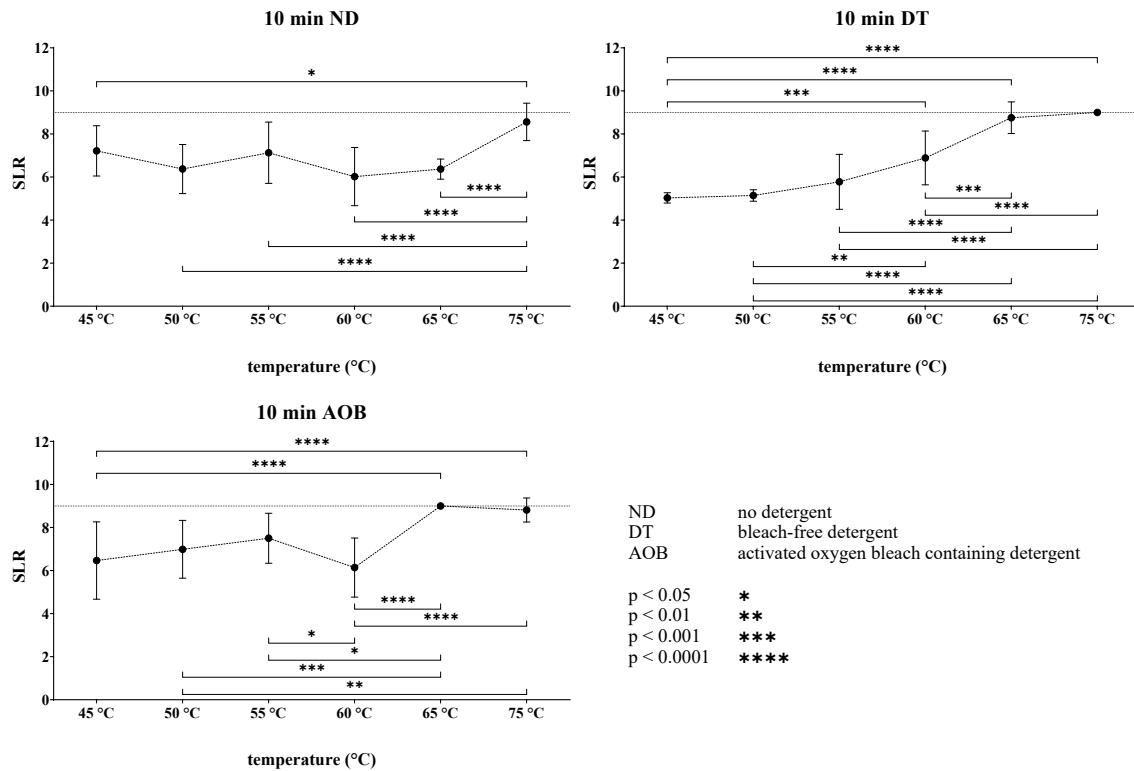

**Figure 44: Overview of the standardized logarithmic reductions (SLR) of *M. luteus* DSM 1790 on biomonitors used in tests with a duration of 5 min. Statistically significant differences caused by a change in the test temperature are marked with asterisks.**

When tests were performed with a duration of 10 min (Figure 45) without the addition of detergent, the SLRs were in the same range with temperatures between 45 °C and 65 °C and were significantly higher at 75 °C.

When bleach-free detergent was used, each temperature increase led to slight increases in the SLR with the SLRs achieved at temperatures of 65 °C and above being close to or reaching the maximum SLR.

With the use of AOB-containing detergent, the increase of the temperature led to a nearly linear increase of the SLR between 45 °C and 55 °C. The SLR at 60 °C is lower than could have been expected and does not fit into the range of the other values detected as the SLRs detected at 65 °C and 75 °C were close to or at the maximum SLR.



**Figure 45: Overview of the standardized logarithmic reductions (SLR) of *M. luteus* DSM 1790 on biomonitors used in tests with a duration of 10 min. Statistically significant differences caused by a change in the test temperature are marked with asterisks.**

In tests with a duration of 15 min (Figure 46), significant increases of the SLR were detected when the temperature was increased to 75 °C in tests without detergent.

When bleach-free detergent was used, increases to temperatures of 65 °C and above showed significantly higher SLRs.

When AOB-containing detergent was used, reductions could be significantly increased by raising the temperature from either 45 °C or 55 °C to 65 °C and above.



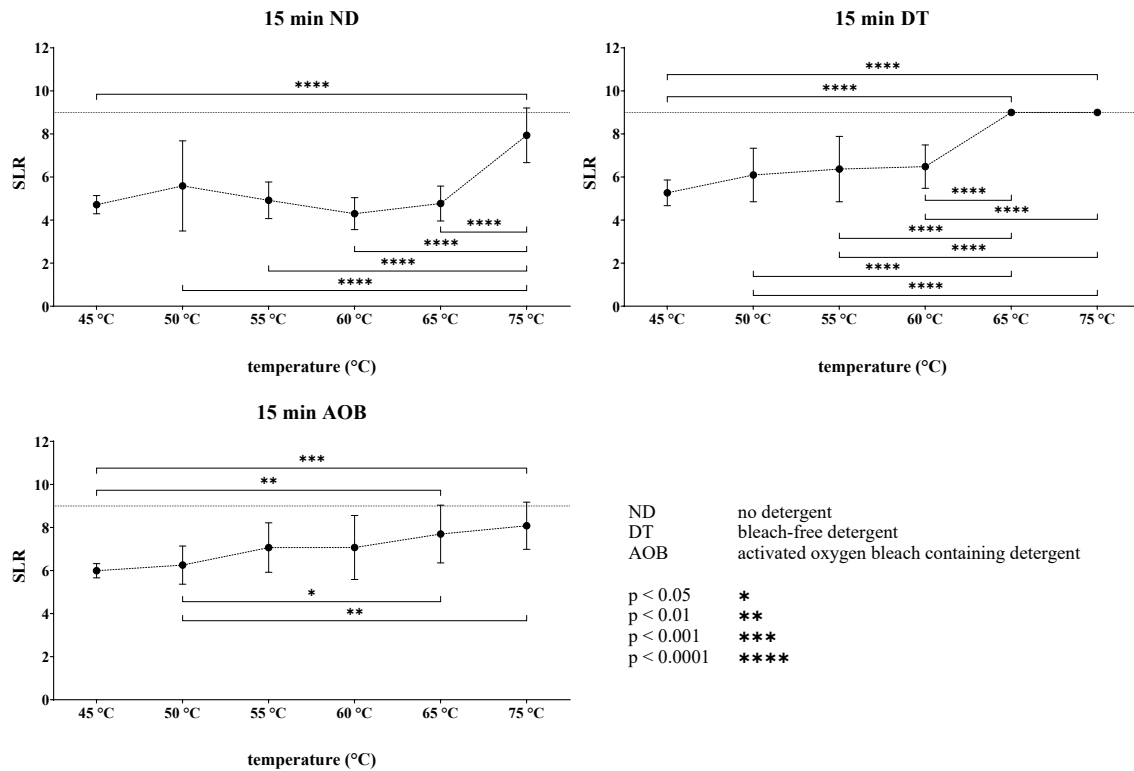
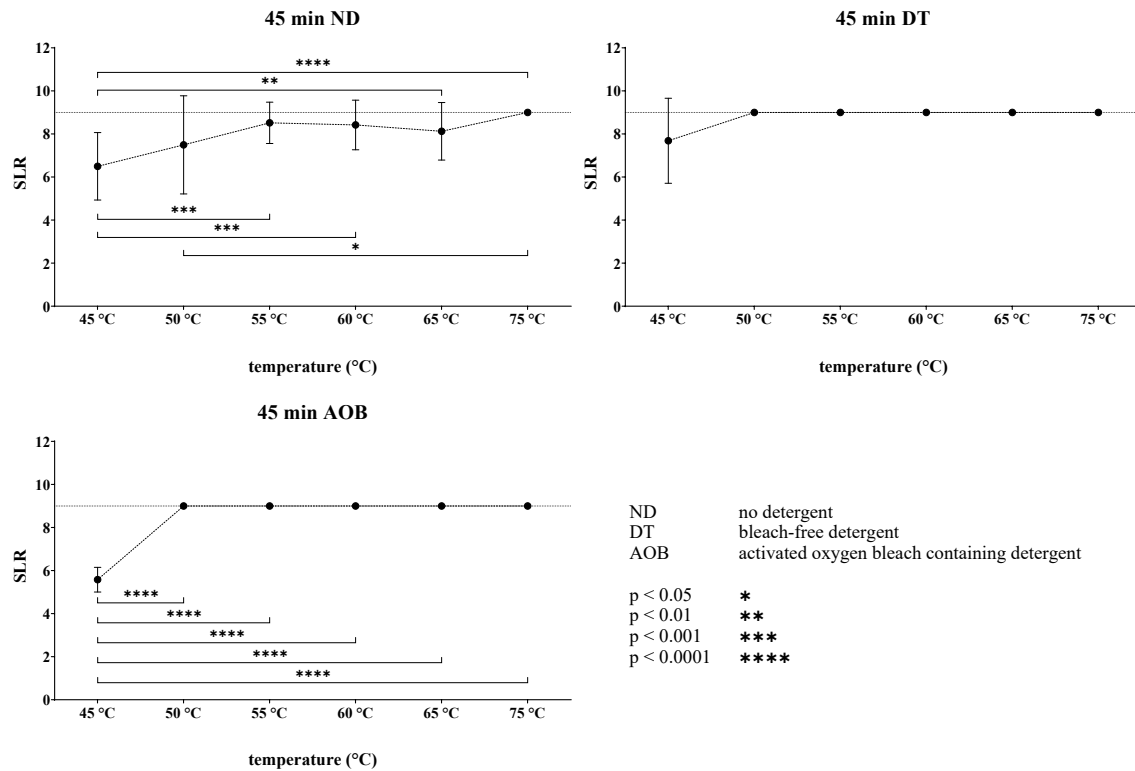

**Figure 46: Overview of the standardized logarithmic reductions (SLR) of *M. luteus* DSM 1790 on biomonitors used in tests with a duration of 15 min. Statistically significant differences caused by a change in the test temperature are marked with asterisks.**

In tests with a duration of 45 min (Figure 47), in test cycles without detergent, the increase of the temperature from 45 °C to 55 °C or above significantly increased the SLR. A significant increase of the SLR was also detected when the temperature was increased from 50 °C to 75 °C.

When bleach-free detergent was used, the SLR-differences detected between 45 °C and higher temperatures were not significant. Complete reduction was detected in all tests with temperatures of 50 °C and above.

With AOB-containing detergent, the SLR could be significantly increased when raising the temperature from 45 °C to at least 50 °C. At this temperature and above, complete reductions were achieved.



**Figure 47: Overview of the standardized logarithmic reductions (SLR) of *M. luteus* DSM 1790 on biomonitors used in tests with a duration of 45 min. Statistically significant differences caused by a change in the test temperature are marked with asterisks.**

In tests with a duration of 90 min (Figure 48), the increase of the temperature from 45 °C to every other tested temperature significantly increased the SLR when either no detergent or AOB-containing detergent was used.

In tests with bleach-free detergent, complete reduction of the microbial load was achieved at all tested temperatures.

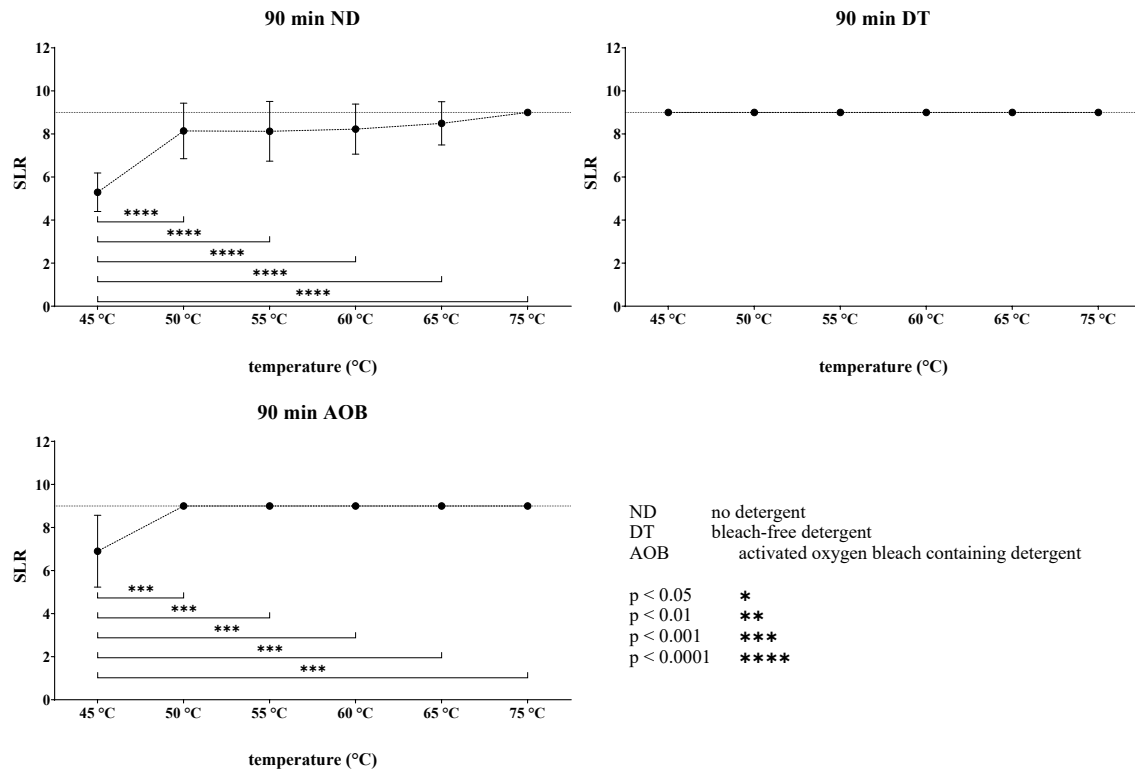

**Figure 48: Overview of the standardized logarithmic reductions (SLR) of *M. luteus* DSM 1790 on biomonitors used in tests with a duration of 90 min. Statistically significant differences caused by a change in the test temperature are marked with asterisks.**

The influence of the rinsing temperature for three different *M. luteus* strains (DSM 1790, DSM 20030<sup>T</sup> and DSM 28269) was determined for the cleaning temperatures of 45 °C and 55 °C. The results are shown in Figure 49.

With a cleaning temperature of 45 °C, *M. luteus* DSM 1790 showed SLRs ranging from 5 with a rinsing temperature of 35 °C to 8.45 when a rinsing temperature of 70 °C was applied. With the higher cleaning temperature of 55 °C, the SLRs were between 7.7 (35 °C rinsing) and 8.8 (70 °C rinsing).

*M. luteus* DSM 20030<sup>T</sup> showed SLRs ranging from 7.3 to 8.4 with a cleaning temperature of 45 °C and between 8.7 and 9 with a cleaning temperature of 55 °C.

The SLRs for the third test strain *M. luteus* DSM 28269 varied between 5.3 (35 °C rinsing) and 8.7 (70 °C rinsing) for the cleaning temperature of 45 °C and between 8.3 (35 °C rinsing) and 8.6 (50 °C rinsing) for the cleaning temperature of 55 °C.

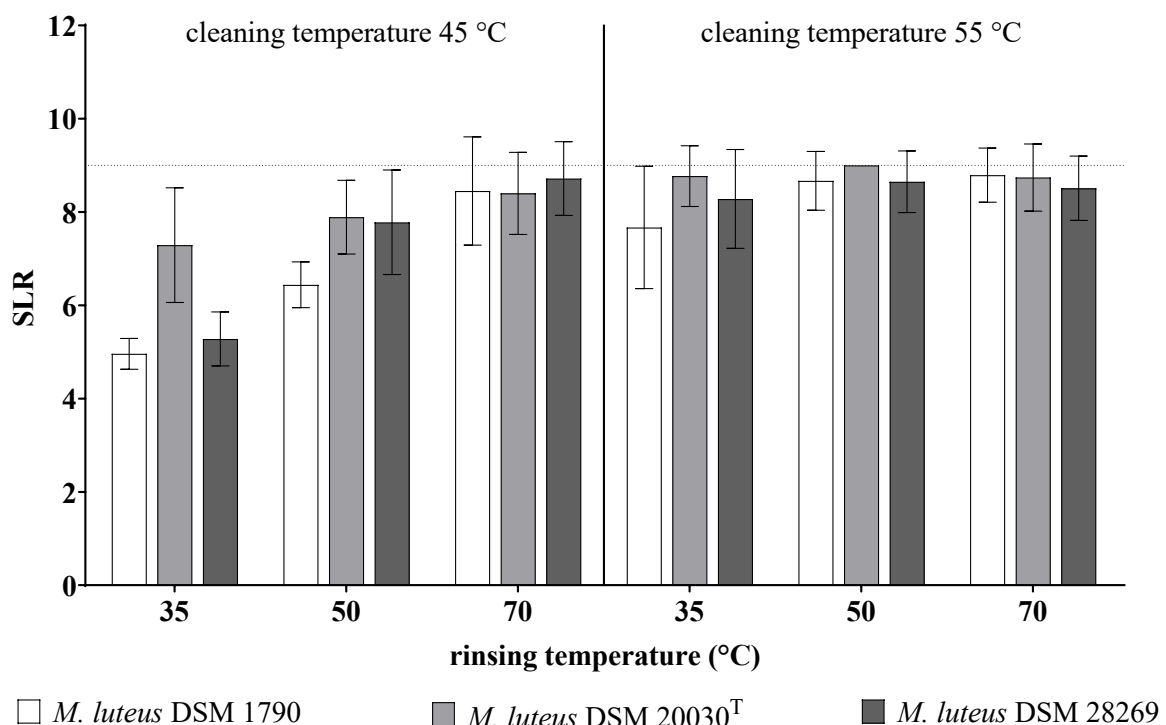
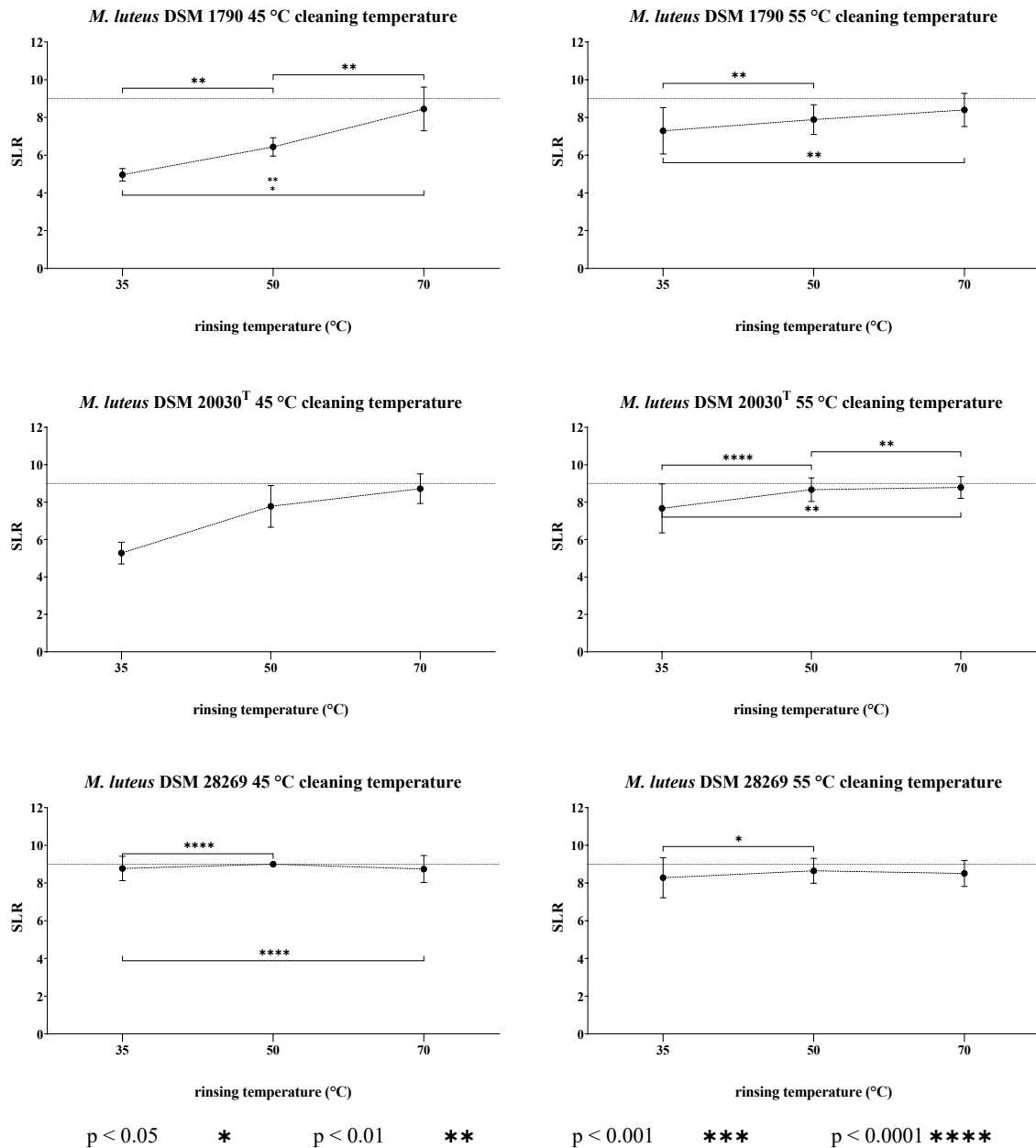

**Figure 49: Standardized logarithmic reductions (SLR) of different *M. luteus* strains on stainless steel biomonitors in dishwasher runs with cleaning temperatures of 45 °C and 55 °C using different rinsing temperatures. Each data point represents means with standard deviations of 3 independent repeats with 3 biomonitors each.**

*M. luteus* DSM 1790 showed significant increases of the SLR with increases of the rinsing temperature in the 45 °C cycles (Figure 50). In the 55 °C cycles, the increase of the rinsing temperature from 35 °C to 50 °C or 70 °C significantly increased the SLR, with no significant differences detected between the two higher rinsing temperatures.

In tests with *M. luteus* DSM 20030<sup>T</sup>, the increase of the rinsing temperature did not lead to significant increases of the SLR in cycles with a cleaning temperature of 45 °C. With the higher cleaning temperature of 55 °C, the differences between the SLRs were significant for all the three tested temperatures.

*M. luteus* DSM 28269 did show a significant increase in the SLR when the rinsing temperature was increased from 35 °C to 50 °C for both tested cleaning temperatures. For the lower cleaning temperature of 45 °C, the SLR was also significantly increased when the rinsing temperature was increased from 35 °C to 70 °C, which was not the case for the higher cleaning temperature of 55 °C.



**Figure 50: Overview of the standardized logarithmic reduction (SLR) of *M. luteus* DSM 1790, *M. luteus* DSM 20030<sup>T</sup> and *M. luteus* DSM 28269 on biomonitors caused by a change of the rinsing temperature in tests with the given cleaning temperatures. Statistically significant differences are marked with asterisks. Lines are for visualization only.**

#### 4.4.2. Detergent

All figures from this section are included in full size in Appendix: Full size figures

In tests with *Ent. faecium* DSM 2146 (Figure 51), the influence of the detergent on the SLR depends on the duration of and the temperature during the cleaning cycle. In the shorter cleaning cycles of 5 min, the addition of bleach-free detergent led to significant higher reductions compared to the cycles without detergent up to a cleaning temperature of 60 °C. Above this temperature, the reductions are too close to the maximum SLR to be able to detect significant differences with the present standard deviations. The addition of AOB-containing detergent did not increase the SLR further; instead, the SLR is significantly lower compared to the cycles with bleach-free detergent at 50 °C and 55 °C.

In the 10 min cycles, significant differences between the cycles with different detergents were only detected at cleaning temperatures of 45 °C, 55 °C and 60 °C. Here, the addition of bleach-free detergent led to significantly higher reductions. At 55 °C, the addition of AOB-containing detergent did significantly increase the SLR further compared to bleach-free detergent. With 45 °C and 60 °C however, the use of AOB-containing detergent did lead to reduced reductions compared to bleach-free detergent.

In the 15 min cycles, the significant differences between the different detergents did show at higher temperatures compared to the shorter cycles. Here, significant differences between cycles without detergent and with bleach-free detergent were detected in all cycles from 55 °C to 75 °C. The use of AOB-containing detergent led to significantly higher reductions than in cycles without detergent at 55 °C to 65 °C. At 55 °C, the reduction with bleach-free detergent was significantly higher than those without detergent or AOB-containing detergent.

In the 45 min cycles, only the tests at 45 °C revealed significant differences between the different detergent types. Here the reduction with bleach-free detergent is significantly higher than in cycles without detergent or AOB-containing detergent.

This was also found in the 90 min cycles. Additionally, at 50 °C, the addition of bleach-free detergent or AOB-containing detergent led to significantly higher reductions compared to the cycles without detergent.

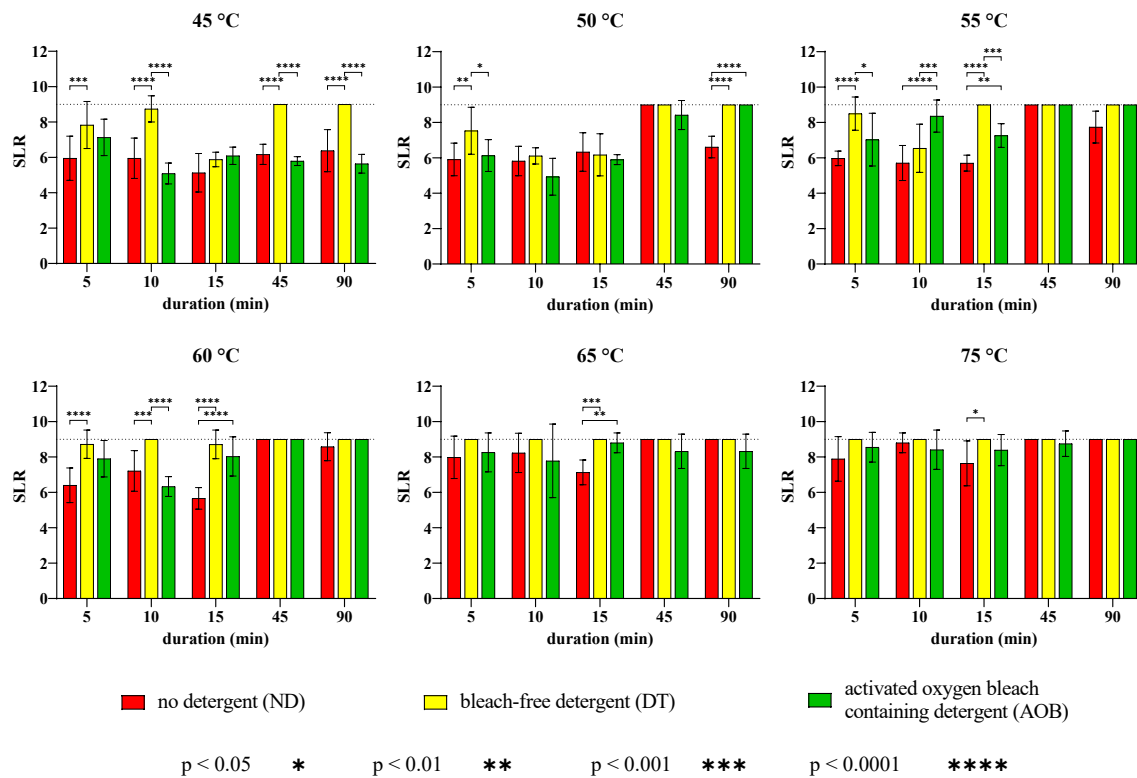

**Figure 51: Overview of the standardized logarithmic reductions (SLR) of *Ent. faecium* DSM 2146 on biomonitors. Statistically significant results caused by different detergent types are marked with asterisks.**

The influence of the detergent on the reduction of *M. luteus* DSM 1790 (Figure 52) depended on the duration and the temperature of the test cycle.

In the 5 min cycles, the reduction with AOB-containing detergent was in general higher or identical to cycles with bleach-free detergent. This difference was only significant at a temperature of 45 °C. The reductions in cycles without detergent and bleach-free detergent were comparable. The only significant difference could be detected at 65 °C, where the cycles with bleach-free detergent gave significantly higher reductions compared to those without detergent.

In the 10 min cycles, the reductions in cycles with AOB-containing detergent were significantly higher compared to those with bleach-free detergent in the 50 °C and 55 °C cycles. In the 45 °C cycles, the reductions with bleach-free detergent were significantly lower than in those without detergent. In the 65 °C cycles, the addition of either bleach-free detergent or AOB-containing detergent led to significant increases of the SLR.



In the 15 min cycles, significant increases of the SLR were detected when AOB-containing detergent was used instead of no detergent in the 55 °C to 65 °C cycles. At 60 °C and 65 °C, the use of bleach-free detergent also led to significantly increased reductions compared to cycles without detergent.

In the 45 min tests, cycles with bleach-free detergent led to significantly higher reductions compared to the cycles with AOB-containing detergent at a temperature of 45 °C.

In the 90 min cycles, all reductions at temperatures of 50 °C and above showed reductions close or equal to the maximum SLR. Only at 45 °C, differences could be observed. Here, the reductions were significantly higher in cycles with bleach-free detergent compared to no detergent. AOB-containing detergent led to significantly higher reductions compared to cycles without detergent, but led to significantly reduced SLRs compared to cycles with bleach-free detergent.

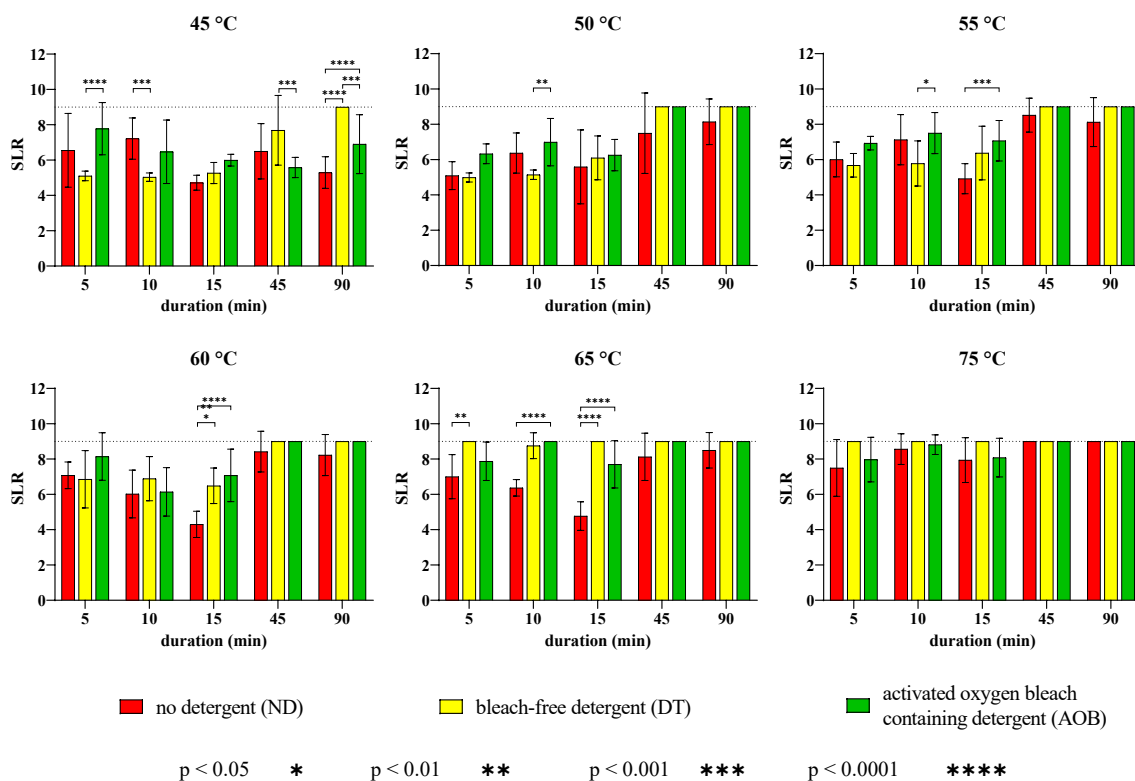

**Figure 52: Overview of the standardized logarithmic reductions (SLR) of *M. luteus* DSM 1790 on biomonitors. Statistically significant differences caused by a change of the detergent are marked with asterisks.**

#### 4.4.3. Duration

After the influence of the temperature and the detergent on the reduction during the dishwashing process, the focus is now on the duration of the cleaning cycle.

The SLRs obtained for tests with *Ent. faecium* DSM 2146 and for *M. luteus* DSM 1790 have been rearranged to visualize the influence of the duration. All figures from this section are included in full size in Appendix: Full size figures.

In the tests with *Ent. faecium* DSM 2146 (Figure 53), according to Sinner's hypothesis, higher SLRs can be expected with longer durations. Analysis of the data revealed some deviations from these expected results. While the SLRs first rose in cycles with a temperature of 45 °C when bleach-free detergent was used, the SLR with a duration of 15 min was significantly lower than all remaining SLRs. When AOB-containing detergent was used in 45 °C cycles, the SLR was highest in the shortest cycles.

In the 50 °C tests, the SLR in the 45 min cycles was highest, higher than in the 90 min cycles when no detergent was used. In the tests with bleach-free detergent, the SLRs in the 10 min and 15 min cycles are lower than those in the 5 min tests.

With a test temperature of 55 °C, the SLR was highest with a duration of 45 min in tests without detergent. This was not to be the value at 90 min, which is lower. In the tests with bleach-free detergent, the value of the 10 min tests is significantly lower than those obtained with all other durations. In the tests with AOB-containing detergent, again the 10 min value is higher than could be expected from the 5 min and 15 min values.

A similar picture is found in the tests without detergent with a temperature of 60 °C. Again, the 10 min value is significantly higher than the one obtained with a test duration of 15 min. Additionally, in the tests with AOB-containing detergent, the 10 min value is significantly lower than the 5 min and the 15 min value which are very similar to each other.

In the 65 °C and the 75 °C tests, the SLRs in the 15 min tests are lower than expected in tests without detergent. In the remaining tests, generally, the SLR rose with the duration, when the standard deviations are taken into consideration.

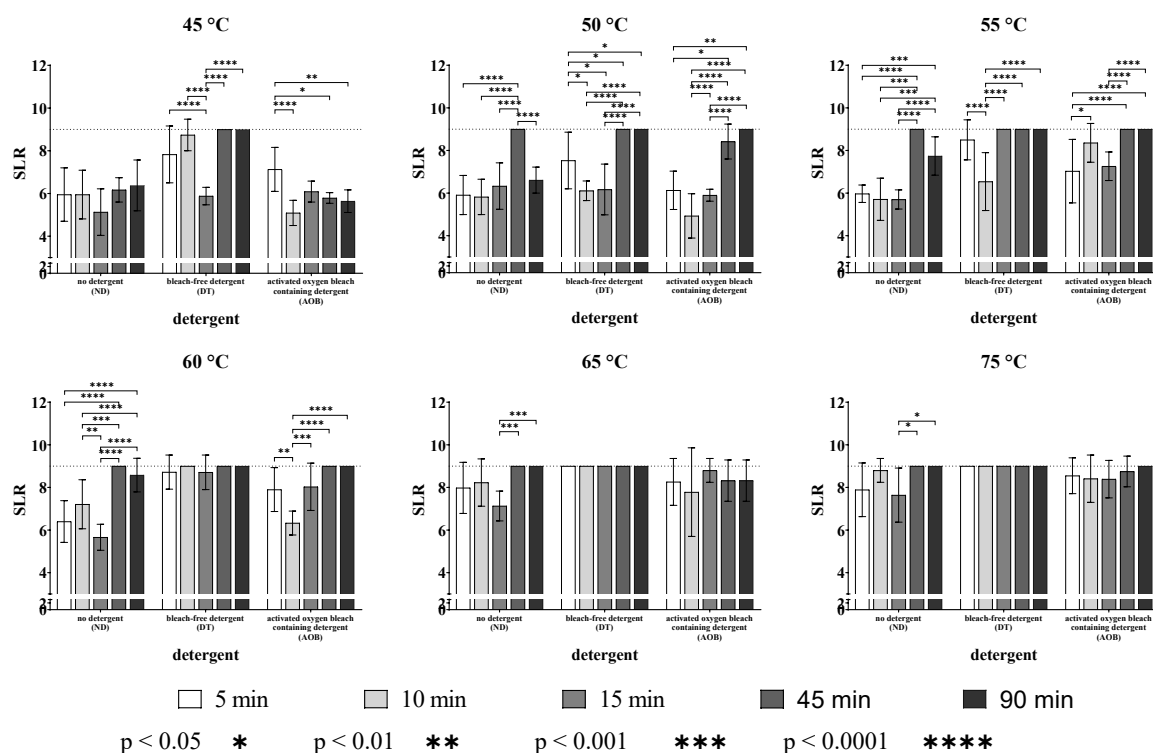

**Figure 53: Overview of the standardized logarithmic reductions (SLR) of *Ent. faecium* DSM 2146 on biomonitors. Statistically significant differences caused by a change of the cleaning duration are marked with asterisks.**

*M. luteus* DSM 1790 (Figure 54) generally shows rising SLRs with longer durations in the tests with different test temperatures.

Again, there are some exceptions from this general rule. In tests without detergent, the SLRs achieved with a duration of 15 min were lower than could be expected from the results with shorter durations for tests with temperatures between 45 °C and 65 °C. In all cases, the SLR with 15 min was significantly lower than with a duration of 10 min. Additionally, in the tests with 45 °C test temperature, the SLR with a test duration of 90 min was also significantly lower than the SLR with a duration of 10 min. This will be discussed in more detail later.

The tests with bleach-free detergent show rising SLRs with increased duration, unless the maximum detectable SLR is reached with more than one combination of parameters.

In the tests with AOB-containing detergent, the tests with temperatures of 45 °C and 60 °C show an unexpectedly high SLR with the test duration of 5 min when compared to the SLRs achieved with durations of 10 min, 15 min and in case of the 45 °C tests 45 min.

Possible explanations for these findings will be discussed later.

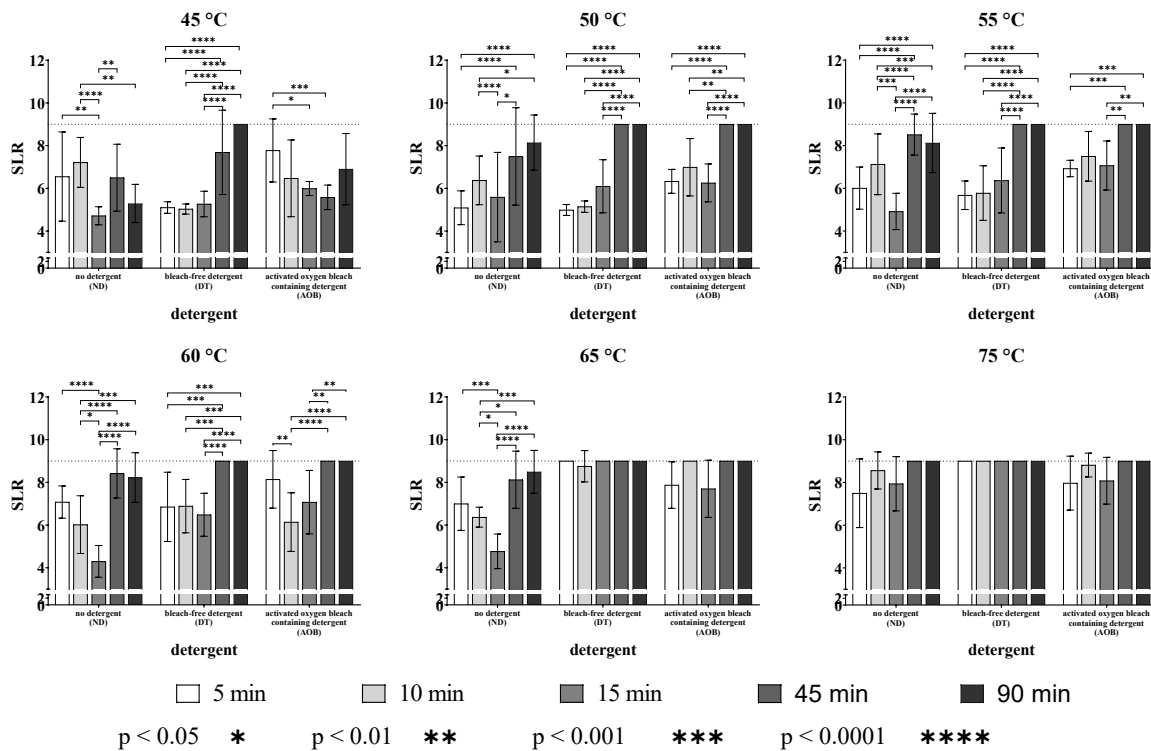

**Figure 54: Overview of the standardized logarithmic reductions (SLR) of *M. luteus* DSM 1790 on biomonitors. Statistically significant differences caused by a change of the cleaning duration are marked with asterisks.**

#### 4.4.4. Mechanical action

As the mechanical action of an automated household dishwasher is part of its usual function, is necessary to clean the soiled goods and is not changeable easily, the influence of the mechanical action alone could not be further analysed. Due to the function, it is included in the duration, as longer durations lead to longer influence of the mechanical action of the water nozzles.

#### 4.5. Cross contamination

The cross-contaminations after extraction of the biomonitors were separately monitored. Results are given in Table 10.

The number of detected cross contaminations is higher in cycles with lower cleaning temperatures and shorter durations. In the longest cleaning cycles, where complete reductions were observed in the tests, no cross contaminations were detected.

**Table 10: Number of cross-contaminations detected after the extraction of stainless steel biomonitors from cleaning cycles in the dishwasher. Each number represents cross contaminations detected on nine biomonitors per condition.**

		45 °C	50 °C	55 °C	60 °C	65 °C	75 °C	
<i>Ent. faecium</i> DSM 2146	5 min	ND	9	8	9	9	4	3
		DT	9	0	1	0	3	0
		AOB	8	7	4	5	6	3
	10 min	ND	6	8	7	9	7	3
		DT	9	6	6	7	3	0
		AOB	9	6	2	8	4	1
	15 min	ND	0	3	7	9	3	3
		DT	6	6	4	7	3	0
		AOB	6	6	4	7	3	0
	45 min	ND	6	0	0	0	0	0
		DT	5	0	0	0	0	0
		AOB	5	0	0	0	0	0
	90 min	ND	5	0	0	0	0	0
		DT	5	0	0	0	0	0
		AOB	5	0	0	0	0	0
<i>M. luteus</i> DSM 1790	5 min	ND	9	7	8	8	7	5
		DT	7	5	6	9	8	0
		AOB	8	7	6	9	7	2
	10 min	ND	9	9	7	9	7	3
		DT	7	2	4	2	2	0
		AOB	9	9	3	9	3	2
	15 min	ND	0	0	2	0	2	0
		DT	4	3	3	3	3	0
		AOB	4	3	3	3	3	0
	45 min	ND	8	0	0	0	0	0
		DT	9	0	0	0	0	0
		AOB	5	0	0	0	0	0
	90 min	ND	4	0	0	0	0	0
		DT	7	0	0	0	0	0
		AOB	7	0	0	0	0	0

#### 4.6. Round Robin tests (ring trial)

Towards the end of the development of the method, with results showing a differentiation between different test conditions, a first small round robin test was performed in three laboratories. The biomonitors were prepared according to the materials and methods section and tests were performed in a dishwasher that was exchanged between the laboratories for the test.

Test cycles with temperatures of 40 ° and 50 °C have been performed in the respective labs in a first test series (I). In a second test series biomonitors were prepared in each of the labs and tested at a central location (II) and in a third test series the biomonitor preparations were done in the respective laboratories with identical materials (III). The results are given in Table 11.

**Table 11: Overview of the logarithmic reductions (LR) achieved on biomonitors from different laboratories. Tests were carried out in the same appliance either in the respective laboratory (I) or with biomonitors from the respective laboratories but tests carried out centrally (II) with identical materials (III).**

laboratory	test	LR			
		40 °C		50 °C	
		mean	SD	mean	SD
A	I	4.59	0.46	4.41	0.77
	II	5.73	0.54	5.01	0.72
	III	6.03	0.59	5.65	0.77
B	I	5.37	0.11	6.90	0.22
	II	5.36	0.20	5.50	0.49
	III	5.65	0.10	5.54	0.38
C	I	6.86	0.70	7.64	0.31
	II	6.87	0.91	7.31	0.94
	III	6.54	0.60	6.52	0.44

## 5. Discussion

The results gathered in the different types of experiments will be combined and discussed together.

Before this, some general remarks about the variations in the determination methods between the suspension tests, the tergotometer tests and the tests in the dishwasher are necessary to be able to classify the value of the results.

When the microbial loads are completely reduced in tergotometer or dishwasher tests, no microorganisms are detectable in the extraction liquid (EL) and no colonies are visible on the incubated agar plate inoculated with the undiluted sample. Due to the nature of the method, the lowest detectable count on the incubated plate is 1 cfu per plate. When a total of 1 mL was spread on four plates, the observable minimal count would be  $1 \text{ cfu} \cdot \text{mL}^{-1}$  EL and the counts would rise in 1 cfu units. Where decimals are given, these results from the formation of means between different counts.

Additionally, even when the lowest physically possible minimal count is  $1 \text{ cfu} \cdot \text{mL}^{-1}$  EL, it is recommended to use only counts within certain limits. The handled limits differ depending on the reference used (Bast, 2014; Deutsches Institut für Normung e. V., 2006b; Madigan *et al.*, 2013) and vary between 10 and 30 cfu per plate or 15 cfu per sample. Based on this and the sample volume used, the lower determination limits vary between  $10 \text{ cfu} \cdot \text{mL}^{-1}$  and  $200 \text{ cfu} \cdot \text{mL}^{-1}$ . For the tergotometer and dishwasher tests, the limit was  $10 \text{ cfu} \cdot \text{mL}^{-1}$  EL, but for the suspension test data cited, the lower detection limit was  $200 \text{ cfu} \cdot \text{mL}^{-1}$  EL. The results obtained by the different tests are thus not of equal resolution because of these different lower detection limits.

### 5.1. Choice of microorganisms

The choice of the microorganisms used in the main part of this thesis was based on suspension tests and initial tests in the dishwasher. Not all of the data were shown. However, the lessons learned from these tests will now be discussed. For *Bacillus subtilis*, data were available from earlier tests in the dishwasher (Brands and Bockmühl, 2015). Here, only occasionally single colonies were found on the cleaned dishes, although the appliances were contaminated with at least  $1 \times 10^9$  cfu before the tests. The mean remaining microbial load in the sump 1 h after the test was between  $4.6 \times 10^6$  cfu · mL<sup>-1</sup> and  $2.6 \times 10^7$  cfu · mL<sup>-1</sup> depending on the sampled device thus giving a LR of 2-3.

The suspension tests performed by Swissatest revealed that the main problem is the formation of spores during suspension tests with comparable conditions with spores being very resistant to the used detergent and resulting in a LR of approximately 1 independent of the temperature and duration applied in the test. Only at 70 °C with addition of AOB-containing detergent, a LR of 3 could be detected (IEC 53A WG3, 2019). *Bacillus subtilis* therefore proved not to be a good test strain.

*Pseudomonas aeruginosa* as well as *Campylobacter jejuni* were tested in suspension tests with several temperatures and bleach-free as well as AOB-containing detergent and initial dishwasher tests at 45 °C without detergent and with AOB-containing detergent. Both kinds of tests revealed that especially *Campylobacter jejuni* was completely reduced even at the lowest temperatures and without detergent, while *Pseudomonas aeruginosa* showed a temperature-dependent reduction in suspension tests without detergent with retrieval of single cells after a contact time of 90 min at a temperature of 60 °C in tests bleach-free detergent (IEC 53A WG3, 2019), but was completely reduced in tests with AOB-containing detergent in suspension as well as dishwasher tests. This sensitivity to activated oxygen bleach and higher temperatures of *Pseudomonas aeruginosa* was already described with laundry detergent containing activated oxygen bleach (Brands *et al.*, 2016a; Honisch *et al.*, 2014a, 2016; Sajitz and Grohmann, 2011).

Although *Candida albicans* is used in several standard to evaluate the effectiveness of disinfecting agents (Deutsches Institut für Normung e. V., 2006c, 2006b) and has been tested in different tests regarding laundry (Brands *et al.*, 2016a; Honisch *et al.*, 2014a; Ossowski *et al.*, 1999; Ossowski and Duchmann, 1997) and has also proven to be resistant against bleach in the suspension tests with dishwasher detergent (IEC 53A WG3, 2019), it was completely reduced in the initial tests in the dishwasher with the lowest possible test temperature. As *Candida parapsilosis* has been frequently isolated from dishwashers (Babič *et al.*, 2015; Döğen



*et al.*, 2013; Zupančič *et al.*, 2016) and has shown to be able to survive on inanimate surfaces as stainless steel and glass for up to 14 days under ambient conditions (Traoré *et al.*, 2002), this might be a candidate strain to assess, although it belongs to BSL2 (Ausschuss für Biologische Arbeitsstoffe, 2016).

Other food-related test strains like *Salmonella* Typhimurium and *E. coli* were completely inactivated when AOB was used in the tests and also in tests without AOB, single cells were only recovered in tests with low temperatures of 40 °C.

*Micrococcus luteus* was tested to be heat resistant (Klapper *et al.*, 2018) and showed resistance against AOB in the suspension tests (IEC 53A WG3, 2019). Initial tests in the dishwasher with three different strains of *M. luteus*, DSM 1790, DSM 20030<sup>T</sup> and DSM 28269 in cycles with a temperature of 45 °C showed that the reductions of the different strains were comparable with durations of 45 min and 90 min, but that DSM 1790 was less reduced in cycles with a duration of 15 min and did therefore differentiate better than the other two strains in cycles without bleach and in cycles with AOB containing detergent.

The test performed to find suitable test strains has shown that Gram-negative bacteria are more easily reduced than Gram-positive strains in cycles with bleach-free detergent and cycles with AOB containing detergent. The tested yeast *Candida albicans* was completely reduced in the initial dishwasher tests at a temperature of 45 °C. Perhaps another species of the genus *Candida*, like *Candida parapsilosis* would give different results.

A comparison of the BSL1 strain *M. luteus* DSM 1790 with the BSL2 strain *Ent. faecium* DSM 2146, which is currently used in tests for commercial dishwashers showed comparable behaviour of both strains. As a result, *M. luteus* DSM 1790 is a suitable test strain and could replace the BSL2 strain *Ent. faecium* DSM 2146.

## 5.2. Biomonitor preparation and behaviour

The round-robin tests revealed three major topics. First, with the biomonitors from laboratory A, no differentiation was possible between the tests with 40 °C and 50 C. The reductions were within one logarithmic step and thus within the natural variation. This was also the case with the biomonitors from laboratory B in two of the three tests and with the biomonitors of laboratory C in the third test series. Second, the LRs achieved with the biomonitors from a single laboratory do vary. This is clearly visible with the biomonitors prepared in laboratory A

tested in cycles with a temperature of 40 °C. Here, the LR was found to vary between 4.6 and 6 with equal standard deviations in all tests. Third, the LRs also differ between the different laboratories. The LRs of laboratory C were always higher than those of the other two laboratories, while the results of laboratory A were lower than those of laboratory B.

Before the test method can be applied in a standard, this phenomenon has to be further elucidated. Possible causes for these differences are the surface of the biomonitor itself. In most of the tests up to now, biomonitors were used several times and the number of uses was not always monitored. The influence of the detergent components and the cleaning and disinfection between the tests could cause a change of the surface profile of the biomonitor causing to alter the profile of the initial granulation. The different surface profiles could lead to differences in the attachment of the test strains to the surface and cause altered removal behaviours (Bollen *et al.*, 1997; Buergers *et al.*, 2007; Costa de Medeiros Dantas *et al.*, 2016; Demilly *et al.*, 2006; Fontes Parizzi *et al.*, 2004; Gusnaniar *et al.*, 2017; Huttenlochner *et al.*, 2017; Ji *et al.*, 2015; Katsikogianni *et al.*, 2004; Mohamad *et al.*, 2013; Truong *et al.*, 2010).

Although tests with new biomonitors and biomonitors used several times have been performed and have not revealed any differences beyond the usual standard deviations found (data not shown), the topic of the biomonitor surface playing a role cannot be ruled out yet due to the small number of comparative tests.

Additionally, the preparation does involve the preparation of starch solution that has to thicken. This thickening is not regulated and thus a highly subjective perception. This might have an influence on the texture and the removability of the soil matrix from the surface and thus directly influence the LR of the microorganisms embedded in this matrix.

The soil matrix itself has an influence on the removal of microorganisms from surfaces as has been shown before in laundering processes (Honisch *et al.*, 2015) and tests with a soil matrix different from the one tested here have been performed for freshwater dishwashers for commercial use (Zinn *et al.*, 2018). The soil matrix from this paper has been tested in a few test cycles and has shown slightly reduced LR values compared to BAMS (data not shown) when the biomonitors were prepared as before only using the altered matrix.

This has been tested with a small number of biomonitors prepared simultaneously by members of two of the test-laboratories using the BAMS matrix as described before. The results (not shown) revealed that if the consistency of the starch component is comparable, the obtained SLRs are much closer to each other. Again, this is based on a very small number of tested biomonitors and should be tested in more detail.

### **5.3. The LR on biomonitors is a combination of removal and inactivation**

In the suspension tests, the inactivation of the bacterial load is tested while in the dishwasher, the reduction on the biomonitors is measured. This reduction on the biomonitor contains two features, the removal from the surface and the inactivation of microorganisms. The tests in the tergotometer give the opportunity to observe the removal from the biomonitor by determination of the remaining load and the inactivation by determination of the remaining count in the water. The data obtained suggest, that at a temperature of 45 °C and durations of 5 min and 10 min, the reduction on the biomonitors is mainly caused by removal from the surface, and only to a relatively small extend by inactivation of the microbial load when *Ent. faecium* DSM 2146 was used as test strain. This phenomenon has been described for the reduction of fungi during laundering processes (Hammer *et al.*, 2011), where in low-temperature processes, a proportion of the microbial load was detected in rinsing water.

This phenomenon is even more pronounced when *M. luteus* DSM 1790 is used as test strain. Here, the microbial count was washed off the biomonitors and detected in the water in tests up to 55 °C and with AOB-containing detergent. Only with a test temperature of 65 °C, the removed load is also inactivated.

For *S. aureus*, this is true for all tests without detergent, while in the tests with detergent, up to 50 °C, removal is found as long as no bleach is used.

This could also be part of the explanation of the cross-contaminations that were detected in the dishwasher mainly in short cycles and with low temperatures in the dishwasher tests. In cycles with durations of 15 min, cross contamination was also detected with higher temperatures when *M. luteus* was used, thus confirming the removal or detachment from the biomonitors rather than an inactivation with these durations.

### **5.4. Use of the standardized logarithmic reduction (SLR) instead of the logarithmic reduction (LR)**

In this thesis, the standardized logarithmic reduction was introduced to facilitate the comparison between reductions achieved with biomonitors from different batches. Although all biomonitors had been produced following identical protocols, the initial count of the different batches differed. When all pre-tests are taken into consideration, the initial counts of *Ent. faecium*

DSM 2146 varied from  $1.5 \times 10^7$  cfu · mL<sup>-1</sup> to  $4 \times 10^9$  cfu · mL<sup>-1</sup> and those of *M. luteus* DSM 1790 from  $8 \times 10^7$  cfu · mL<sup>-1</sup> to  $3.7 \times 10^9$  cfu · mL<sup>-1</sup>.

The differences between the initial counts were 2.4 logarithmic steps for *Ent. faecium* DSM 2146 and 1.7 logarithmic steps for *M. luteus* DSM 1790. The differences found between different test conditions were sometimes relatively small together with the different initial counts, the results could have shown lower reductions with more stringent test conditions and thus give a distorted perception of the real properties.

There were two possible ways to handle these phenomena: give a percentage logarithmic reduction or use a standardized logarithmic reduction.

The percentage logarithmic reduction can be misleading as the logarithmic steps normally used are equal to percentage reductions of 90 % or more, depending on the achieved logarithmic steps.

This would have been mixed with the percentage log-reduction needed in this case, where reductions would have been given as percentage of the initial logarithmic count on the biomonitor.

This was discovered in discussions within small groups, so that the standardized logarithmic reduction is used. As shown in the materials and methods section, the percentage logarithmic reduction is used in the calculation of this value, thus using this number to calculate a total value given based on the highest measured initial count of the batches used.

As these calculations are in fact only transformations of the actual values detected in the experiments, this seems to be the best method to achieve comparable values that are not influenced by different initial counts of the batches of biomonitors.

When the results are closely looked at however, there are a few combinations of parameters that give values that are totally unexpected when taking Sinner's hypothesis and concepts like the A<sub>0</sub>-value into consideration. In some of these cases, the different batches used for the different test parameters did show quite high differences in the initial counts. While standardization was an adequate means for comparability of values with similar initial bacterial counts, it was found that individual results were misinterpreted when differences were very high. This may have led to over- or underestimation of the achieved SLRs.

### 5.5. Comparison between suspension tests, tergotometer and dishwasher tests

In this thesis, tests in the tergotometer and in the dishwasher have been performed. The dishwasher tests were also part of a joint project in which potential test microorganisms have been selected by suspension tests. In this section, the data from these suspension tests were compared to the tests in the tergotometer and in the dishwasher. For the comparison all data were standardized. The initial counts in the suspension tests were given to be between  $2 \times 10^8 \text{ cfu} \cdot \text{mL}^{-1}$  and  $7 \times 10^8 \text{ cfu} \cdot \text{mL}^{-1}$  for *Ent. faecium* DSM 2146 and  $3 \times 10^8 \text{ cfu} \cdot \text{mL}^{-1}$  and  $9 \times 10^8 \text{ cfu} \cdot \text{mL}^{-1}$  for *M. luteus* DSM 1790 with the lower detection limit of  $200 \text{ cfu} \cdot \text{mL}^{-1}$ . Suspension test data were taken from literature (Amberg, 2018; IEC 53A WG3, 2019) and were standardized to a maximum detectable reduction of 9 (as in the dishwasher) as described before. To calculate the % LR, the initial counts were calculated from the maximum detectable reduction and the lower detection limit. The results of the comparison are given in Table 12.

One has to be aware of the fact that a bleach-system that generates peracetic acid is used in the tests with detergent containing activated oxygen bleach. Peracetic acid has shown to remove *Ent. faecium* DSM 2146 from stainless steel (Andrade *et al.*, 1998). It is unclear, whether this is also the case for other microorganisms. Additionally, this might have led to increased reductions when compared to the suspension tests.

**Table 12: Comparison of SLRs from suspension tests (ST), tests in the tergotometer (TM) and in the dishwasher (DW) with AOB-containing detergent. Suspension test data are taken from literature (Amberg, 2018; IEC 53A WG3, 2019).**

		15 min			45 min			90 min		
		ST	TM	DW	ST	TM	DW	ST	TM	DW
<i>Ent. faecium</i> DSM 2146	40 °C	1.57	n.a.	n.a.	4.09	n.a.	n.a.	7.36	n.a.	n.a.
	45 °C	2.38	≥ 9	6.09	5.51	n.a.	5.79	8.01	n.a.	5.64
	50 °C	2.28	≥ 9	5.90	6.27	n.a.	8.42	7.96	n.a.	≥ 9
	55 °C	7.89	4.45	7.26	8.27	n.a.	≥ 9	8.93	n.a.	≥ 9
	60 °C	≥ 9	n.a.	8.03	≥ 9	n.a.	≥ 9	8.02	n.a.	≥ 9
	65 °C	≥ 9	≥ 9	8.80	≥ 9	n.a.	8.32	≥ 9	n.a.	8.32
<i>M. luteus</i> DSM 1790	40 °C	1.64	n.a.	n.a.	5.73	n.a.	n.a.	7.62	n.a.	n.a.
	45 °C	3.20	4.16	5.99	7.57	n.a.	5.58	8.95	n.a.	6.90
	50 °C	4.68	5.06	6.25	8.62	n.a.	≥ 9	8.79	n.a.	≥ 9
	55 °C	7.02	5.66	7.07	≥ 9	n.a.	≥ 9	8.37	n.a.	≥ 9
	60 °C	≥ 9	n.a.	7.07	≥ 9	n.a.	≥ 9	≥ 9	n.a.	≥ 9
	65 °C	≥ 9	8.92	7.70	≥ 9	n.a.	≥ 9	≥ 9	n.a.	≥ 9

When the data of the suspension tests and the dishwasher tests with a duration of 15 min were compared, there were some similarities.

With *Ent. faecium* DSM 2146 for example, both the suspension tests and the dishwasher tests showed the highest increase of the SLR between 50 °C and 55 °C. The reductions with the lower temperatures were much higher in the dishwasher with 1.57 in the suspension test compared to 6.09 in the dishwasher test with a test temperature of 45 °C. Generally, in the dishwasher higher reductions are reached with lower temperatures indicating an influence of the mechanical action.

The 15 min tests in the tergotometer showed complete reductions except for the 55 °C test and did not show similarities to either the suspension tests or the tests in the dishwasher.

Especially the values detected at 50 °C and in part at 45 °C and 55 °C in the tergotometer were achieved with a batch of biomonitors with an initial count that was almost 2 logarithmic steps lower than the rest. The standardization might have led to a wrong estimation of the SLRs achieved by that batch. This could at least partly explain the strange observations with a temperature of 55 °C in the 5 min tests without detergent and with bleach-free detergent. Here, the SLRs observed are above those to be expected. The observed total reduction in the tests without detergent was achieved on biomonitors with the lower initial load. With a higher initial load, there might have been a remaining count, but this is pure speculation. Additionally, this does not explain the very low reduction with a test temperature of 65 °C.

These findings, together with the microbial load in the water being under the lower detection limit clearly oppose the possibility of a pure detachment from the surface into the water.

Similar unexpected findings were detected in the tests with durations of 10 min and 15 min. Here, rather unexpected SLR values are found with test temperatures of both 50 °C and 55 °C. While the higher-than-expected SLRs at 50 °C could be explained by the lower initial microbial count and a resulting over-estimation of the reduction, the remaining tests were performed with biomonitors from a single batch. This raises the questions, why the SLR at 55 °C is significantly higher than the one at 65 °C in the tests with bleach-free detergent and in tests with AOB-containing detergent.

These unexpected SLRs only occur with the biomonitors inoculated with *Ent. faecium* DSM 2146. The performed heat resistance tests show, that the heat alone is not the cause for the observed reduction of the microbial load.

A possible explanation for these findings is a temperature mistake during the test. The tergotometer uses a device to adjust the temperature of the water bath, in which the test vessels are situated. The temperature is controlled by a build-in thermometer, but not checked externally and thus could have been incorrectly measured by the device. It is unclear however, whether these problems occurred and if so, which results have been affected.

Thus, it remains unclear, whether the SLRs for *Ent. faecium* DSM 2146 observed in the tergotometer are trustworthy, especially as they would disprove Sinner's principle that has been confirmed elsewhere for comparable yet different systems (Honisch *et al.*, 2014b; Müller-Kirschbaum *et al.*, 2020).

For *M. luteus* DSM 1790, there were slight increases between the suspension tests (LR 3.2), tergotometer (LR 4.16) and the dishwasher tests (LR 5.99) at 45 °C and a similar increase at 50 °C with higher values in each test type. The difference between the suspension test and the tergotometer is the mechanical action, with an increase of 1 logarithmic step. The difference between the tergotometer and the dishwasher is the additional rinsing step on the one hand and the use of rinse aid on the other hand which taken together led to the increase of 1.8 log-steps.

With temperatures of 55 °C and above, the suspension tests do show higher SLRs than the dishwasher. Whether this is due to the fact that the microorganisms are continually submerged here in contrast to the dishwasher remains unclear.

With longer durations of 45 min and 90 min, both suspension tests and dishwasher tests showed complete reductions at temperatures of 60 °C and 65 °C. With temperatures of 50 °C and above, the reductions in the dishwasher were higher (or equal with a temperature of 55 °C and a duration of 45 min) than in the tergotometer. With the test temperature of 45 °C, the reductions in the suspension tests were higher than in the dishwasher.

Although there are again unexpectedly low SLRs in the 5 min and 10 min tests in the tergotometer with a temperature of 55 °C, the general increase in the SLR with higher temperatures as can be expected following Sinner's hypothesis remains intact. The repeated occurrence of these deviations at 55 °C indicates a systematic error at this test temperature.



## 5.6. Effect of different factors on the reduction in dishwashing

It is a challenge to identify the impact of a single factor during the complex automated dishwashing process, especially as the change in one factor (*e.g.* temperature) often also causes a change in another factor (duration in this case). Additionally, the two test strains *Ent. faecium* DSM 2146 and *M. luteus* DSM 1790 did not behave totally similar.

The results from the automated dishwasher will be evaluated together with the results from the hand dishwashing and the tergotometer tests to identify the influence of the different factors.

### 5.6.1. Influence of the cleaning and rinsing temperatures

The obtained dishwasher test data have been analysed according to their dependence on the temperature as one of the influence factors from Sinner's circle (Sinner, 1960). Here, four-parameter logistic regression (4PL) was used for the cleaning temperature and linear regression was used for the rinsing temperature. The results are presented in the following two sections.

#### 5.6.1.1. Four-parameter logistic regression

The 4PL regression model was able to describe most of the reductions observed in the dishwasher tests. The parameters that have been calculated for the curves are given in Table 13. Next to the values for the curve parameters, the table also contains values for determination of the goodness of fit. These are degrees of freedom (dF), absolute sum of squares (ASS), the standard error of the estimate (SEE) and the number of outliers.

The ASS gives the sum of the squared vertical distances of the data points from the calculated curve. The better the fit of the curve, the smaller the ASS. The SEE gives the scatter of the real data points around the regression curve. The closer this value is to zero, the better the fit. Finally, the outliers show how many data points could not be fit to the regression line. The fewer outliers there are, the better the fit of the model.

**Table 13: Overview of the parameters obtained from 4PL regression for *Ent. faecium* DSM 2146 and *M. luteus* DSM 1790 tests in the dishwasher. Only the test series with clear regression curves are included. All values were rounded to the third decimal place.**

parameter	<i>Ent. faecium</i> DSM 2146				<i>M. luteus</i> DSM 1790				
	treatment				treatment				
	05 min AOB	10 min ND	15 min AOB	90 min ND	05 min ND	05 min DT	10 min DT	15 min DT	15 min AOB
<b>upper asymptote (d)</b>	8.457	8.696	8.535	9.022	7.253	9.145	9.128	9.015	8.569
<b>lower asymptote (a)</b>	6.650	5.786	5.927	6.307	5.828	5.164	5.125	5.910	5.206
<b>point of inflection (c)</b>	58.30	60.41	55.29	54.88	57.51	60.35	60.17	61.18	55.49
<b>hill's slope (b)</b>	27.45	29.47	25.80	20.53	45.75	31.85	23.38	76.12	5.926
<b>R<sup>2</sup></b>	0.340	0.623	0.703	0.705	0.196	0.846	0.812	0.690	0.318
<b>degrees of freedom (dF)</b>	50	50	50	50	50	50	50	50	50
<b>absolute sum of squares (ASS)</b>	61.53	47.96	26.89	29.90	96.09	27.63	32.13	47.72	60.35
<b>standard error of the estimate (SEE)</b>	1.109	0.979	0.733	0.720	1.386	0.743	0.802	0.977	1.099

The selected curves all have ASS values that are acceptable. Together with the SEE values and the number of outliers, the regression curves can be said to fit the data quite well. The measured reductions can thus be well explained with the developed model for the given conditions.

It is obvious, that not all of the tested conditions are given in this table. For the remaining conditions, no satisfactory fit could be calculated. This reveals that the temperature is one of the factors that influence the reduction, but is not sufficient to explain all difference in the SLR.

The data allow for a prediction of the SLRs achieved in tests within the boundaries covered by the data in the model. So, for each temperature between 45 °C and 75 °C in this particular machine, a prediction was made that is described with the equation given with the parameters

above and the ASS and the SEE describe the quality of this prediction. The smaller these two values are, the better the prediction. The values for the ASS and SEE show, that the models do not predict the SLRs well, showing the need for a better model.

### 5.6.1.2. Linear regression

The results of the linear regression analysis for the influence of the rinsing temperature in the reduction are given in Table 14. The table summarizes the slope and vertical intercepts of the regression lines and parameters to determine the goodness of fit. These are the  $R^2$ , which multiplied by 100 gives information about the proportion of the variance that is explainable by the linear regression model of the rinsing temperature. The standard error of the estimate (SEE) gives the scatter of the real data points around the regression line. The closer this value is to zero, the better the fit. The F-value gives an indication whether the variable rinsing temperature can explain the model and if so, to which extend.

**Table 14: Overview of the parameters obtained from 4PL regression for *Ent. faecium* DSM 2146 and *M. luteus* DSM 1790 tests in the dishwasher. All values were rounded to the third decimal place.**

main cleaning temperature (TC in °C)	45 °C			55 °C		
<i>M. luteus</i> strain	1790	20030 <sup>T</sup>	28269	1790	20030 <sup>T</sup>	28269
slope ( $e$ in °C <sup>-1</sup> )	0.09255	0.01183	0.07847	0.03045	0.004655	0.009369
vertical intercept ( $f$ )	1.670	6.674	2.635	6.738	7.797	7.305
goodness of fit ( $R^2$ )	0.7672	0.02769	0.6365	0.1974	0.01327	0.03187
standard error of the estimate (SEE)	0.7596	1.045	0.8835	0.9148	0.5981	0.7694
Overall significance of the model (F)	82.39	0.7121	43.78	6.150	0.3362	0.8230
degrees of freedom (dF) numerator	1	1	1	1	1	1
degrees of freedom (dF) denominator	25	25	25	25	25	25
p-value	< 0.0001		< 0.0001	0.0202		

At the cleaning temperature of 45 °C, the rinsing temperature can explain the differences in the reduction for 76.7 % for strain DSM 1790, 2.769 % for strain DSM 20030<sup>T</sup> and 63.65 % for strain DSM 28269. Both the SEE and F values for strains DSM 1790 and DSM 28269 are at acceptable levels and together with the p-values show that the influence of the rinsing temperature is significant for the retrieved reduction.

At the higher cleaning temperature of 55 °C, the R<sup>2</sup> values are generally lower. Only for strain DSM 1790, the explained proportion of the variance is above ten percent. Together with the SEE value and the p-value, the influence of the rinsing temperature can be observed as significant on the model.

These results indicate that the cleaning temperature as well as the rinsing temperature do have significant effects on the achieved LR.

Next, random forest analysis was used to determine the factors that are most relevant for the variation in the LRs observed.

#### **5.6.1.3. Identification of the factors with the highest influence by random forest analysis**

With the analysis of the dishwasher data for *Ent. faecium* DSM 2146 it was possible to identify the factors that had the highest influence on the reductions revealed two principal components explaining 99% of the variation in the data. These two principal components are defined by the analysed features. The first principal component was determined by the factor duration of the cleaning cycle, the second one by the factor temperature. This reveals that those two factors mainly influenced the observed reduction, while the influence of the detergent was only minimal.

The analysis of the data of *M. luteus* DSM 1790 was also able to identify the two components that were able to explain 99% of the variation in the data. The first principal component is defined by temperature. The second principal component is defined by duration. So, for *M. luteus* DSM 1790, the obtained reduction is mainly explained by the two factors temperature and duration of the cleaning cycle.

The regression analysis by the random forest algorithm delivered different values which can be used to evaluate the quality of the regression model. These are shown in Table 15.

**Table 15: Overview of values received during random forest regression analysis for *Ent. faecium* DSM 2146 and *M. luteus* DSM 1790.**

		mean square error (MSE)	root mean square error (RMSE)	mean absolute error (MAE)	R <sup>2</sup>
<i>Ent. faecium</i> DSM 2146	random forest	1.368	1.170	1.002	0.426
	linear regression	1.597	1.264	1.038	0.330
<i>M. luteus</i> DSM 1790	random forest	1.757	1.325	1.126	0.428
	linear regression	1.822	1.350	1.101	0.407

The random forest regression gives R<sup>2</sup> values between 0.33 and 0.42. These values for the coefficient of determination are very low showing that the achieved reductions cannot be predicted very well with this model.

Although the data do not show Gaussian distribution, a three-factor ANOVA gave the same results. Here, a clear interaction between the factors temperature, duration and detergent was detected. Thus, simple models are not reliable in the prediction of the reduction.

It has been demonstrated before, that microorganisms are inactivated by heat (Smelt and Brul, 2014) and that the duration for a decimal reduction (*D*-value) is dependent of the microorganism and the circumstances under which the inactivation happens (Coleman *et al.*, 2007; Setlow and Setlow, 1998; Zhang *et al.*, 2010).

The *D*-value concept is based on the thermal inactivation (to be precise killing) of a microorganism. This requires the killing of the microorganism in place. This value may be adequate for the inactivation of microorganisms on surfaces or medical equipment, but is not suitable for the reduction of the microbial load in a (household) dishwasher as it does not take the detachment of microorganisms from a surface into account. In dishwashers, the cleaning process is based on the removal of remaining material from the surface. This is also likely to happen to at least part of the microbial load on the surface, thereby reducing the microbial load.

The duration necessary for the removal depends on different factors starting with the surface structure of the material (roughness), the surrounding components (matrix composition), the presence or absence of detergent or detergent components and the temperature of the washing water. Except for the temperature, none of these are included in the *D*-value concept, making this concept insufficient for predictions of the microbial reduction. The influences of the different factors in the dishwasher are discussed in the following sections in more detail.

### 5.6.2. Influence of the cleaning duration

The effect of the cleaning duration depends on the test microorganism and the kind of detergent used in the cleaning cycles.

For *Ent. faecium* DSM 2146, the biggest increase in the SLR was achieved when the duration was extended from short cycles up to 15 min to 45 min or 90 min. When the durations are extended within the shorter time frames up to 15 min, the expansion did not increase the SLR. The same is true for an expansion from 45 min to 90 min, where an expansion led to decreased reductions.

When AOB-containing detergent was used, the expansion only showed increases with temperatures between 50 °C and 60 °C.

With *M. luteus* DSM 1790 as test organism, the picture was quite similar. Extended durations led to an increase of the LR up to 4 logarithmic steps in cycles without detergent and bleach-free detergent. When AOB-containing detergent was used, the increase was a bit lower, but still clear.

Similar results were discovered in suspension tests with laundry detergents (Brands *et al.*, 2016a) and laundering tests (Fijan and Šostar-Turk, 2010) as well as with sanitizer tests on surfaces (Carballo and Araújo, 2012). In all of these studies, short contact times limit the efficacy of the used treatment.

During the cleaning process in the automated dishwasher, the protein and starch-based soil initially undergoes a swelling process. A study revealed that this process takes up to 20 min and that the soil is properly removed only after a successful swelling period. (Bird and Fryer, 1991; Goode *et al.*, 2013; Pérez-Mohedano *et al.*, 2017). In the shortest test cycles, the time could be

too short for a successful swelling period thus resulting in incomplete removal of the soil matrix from the surface and thereby explaining the higher remaining microbial loads under these conditions.

### 5.6.3. Influence of the detergent

The influence of the detergent depends on the test microorganism and the chosen temperature and duration parameters in the tests.

In tests with *Ent. faecium* DSM 2146 and a cleaning duration of 5 min, the use of bleach-free detergent increases the SLRs up to 60 °C, while the addition of AOB-containing detergent did decrease the SLR at 50 °C and 55 °C. These decreases by AOB-containing detergent instead of bleach-free detergent were also present in the 10 min cycles (except for 55 °C), while the addition of detergent did increase the reduction compared to cycles without detergent. In the 15 min cycles, the effect of the detergent was only visible with temperatures of 55 °C and above and revealed that the addition of detergent did increase the SLR compared to cycles without detergent, while a change from bleach-free to AOB-containing detergent did not positively influence the reductions observed. In the longer cycles, the detergent did cause changes of the SLR at the lowest temperatures. Here, significant increases were caused by the addition of bleach-free detergent at 45 °C, while the addition of AOB to the system significantly decreased the SLR. This difference has to be caused by the bleach-system components, but how it is caused remains unclear. In the 90 min cycles, the addition of either type of detergent led to increased reductions at 50 °C. In contrast to 45 °C, the addition of the bleach components did not reduce the reductions here. This could give an indication that the temperature might play a role in the process with the critical temperature for the negative effect seen in the 45 °C tests lying somewhere between 45 °C and 50 °C. This could be due to the perhydrolysis rate of the bleaching components which in laundering processes were on the one hand shown to be decreasing with lower temperatures but on the other hand showed increased lifetimes of the peracid with lower temperatures (Milne, 1998) It is possible, that in the 90 min test cycles, the ideal temperature is present for longer time spans thus increasing the bleach activity and increasing the SLR.

This would be an interesting topic to analyse in future studies.

In tests with *M. luteus* DSM 1790, the influence of the detergent is most prominent in cycles with a duration of 15 min. At temperatures from 55 °C to 75 °C, there were significant increases in the SLR when AOB-containing detergent was used compared to cycles without detergent. Additionally, there was a significant increase in the SLR in tests with temperatures of 60°C and 65 °C, when bleach-free detergent was used instead of no detergent.

With shorter cleaning cycles of 5 min and 10 min and a temperature of 65 °C, the use of bleach-free detergent leads to higher reductions. In tests with temperatures of 50 °C and 55 °C, the SLR could be significantly increased by AOB-containing detergent compared to bleach-free detergent. This could be caused by the removal of bacterial load from stainless steel by peracetic acid as was shown for *Ent. faecium* (Andrade *et al.*, 1998), while the increase in the 15 min cycles could be due to a combination between the removal by peracetic acid and facilitated swelling processes.

In the 45 °C tests, the use of AOB-containing detergent instead of bleach-free detergent did significantly decrease the SLR in tests with durations of 45 min and 90 min. This observation is strange, as the chemical inactivation by the bleach should result in higher SLRs. As this phenomenon only occurs at this low temperature, this could be due to a combination of insufficient bleach activation paired with a possible re-distribution of the washed-off microbial load. Why this is re-allocation of the load is not observed in tests with bleach-free detergent remains unclear.

#### **5.6.4. Influence of the mechanical action**

The influence of the mechanical action could only be observed, when the data from suspension tests and tergotometer test were compared, but the mechanical action found here differs immensely from the action found in the dishwasher.

The biomonitors are submerged in water during the whole duration in the tergotometer, while in the dishwasher, the biomonitors are repeatedly hit by water sprayed up from the spray arms. The force of this water depends on the dishwasher and can hardly be categorized.



However, to give a first impression of the influence achieved by rotation-induced shear forces with the dishwasher detergent, the differences achieved by this rotation for a duration of 15 min are given in Table 16.

**Table 16: Differences in the SLR between suspension tests and tests in the tergotometer. The detected differences may be caused by the mechanical action of the rotation and the attachment of the microbial load to the biomonitors.**

temperature	$\Delta LR$ mechanical action	
	<i>Ent. faecium</i> DSM 2146	<i>M. luteus</i> DSM 1790
45 °C	6.62	0.96
50 °C	6.72	0.38
55 °C	-3.44	-1.36
65 °C	0	-0.08

The mechanical action did increase the LR at low temperatures up to 50 °C. Above this border, the mechanical action seems to negatively influence the LR. The influence was significantly higher with *Ent. faecium* DSM 2146 as test strain compared to *M. luteus* DSM 1790.

The mechanical action does also play a role in different dishwasher cycles. With higher temperatures or longer chosen durations, the spray arms move longer and more mechanical action is applied to the surfaces. The effects found in cycles with higher temperatures or longer durations could thus be combinations of the effect by the changed parameter in combination with the altered mechanical action effect.

### 5.7. Interaction of parameters in dishwasher tests

As mentioned before, even though the influence of the single parameters was investigated in this study, there is always an interaction of the different parameters when using an automated dishwasher. When the mean SLRs are visualized, some unexpected values can be easily detected. These visualizations are shown in the following two paragraphs, starting with the tests using *Ent. faecium* DSM 2146 (Figure 55, Figure 56 and Figure 57) as test organism followed by those with *M. luteus* DSM 1790 as test organism (Figure 58, Figure 59 and Figure 60). The standard deviations are not shown for reasons of legibility, but the values presented before were used.

The SLRs achieved in tests with *Ent. faecium* DSM 2146 using no detergent (Figure 55) revealed an unexpected decrease in the SLRs with a test duration of 15 min compared to the shorter durations of 5 min and 10 min with the exception of a temperature of 50 °C. Here, the SLRs are lower with all tested temperatures. Why this phenomenon occurs with exactly this duration is an open question. One possible explanation could be a relocation of already removed bacteria from the water back to the surface with the longer duration of 15 min. Further prolongation would then remove the relocated microbial load again as observed in the 45 min tests.

Additionally, the SLR observed with a duration of 45 min and temperatures of 50 °C to 60 °C are higher than those achieved with the longer duration of 90 min. One would expect a higher reduction with longer durations, but this was not the case.

Another explanation would be the already mentioned differences in the initial count, leading to over- or under-estimations of the achieved reduction.

In general, for each temperature observed separately, higher temperatures led to higher reductions as could be expected.

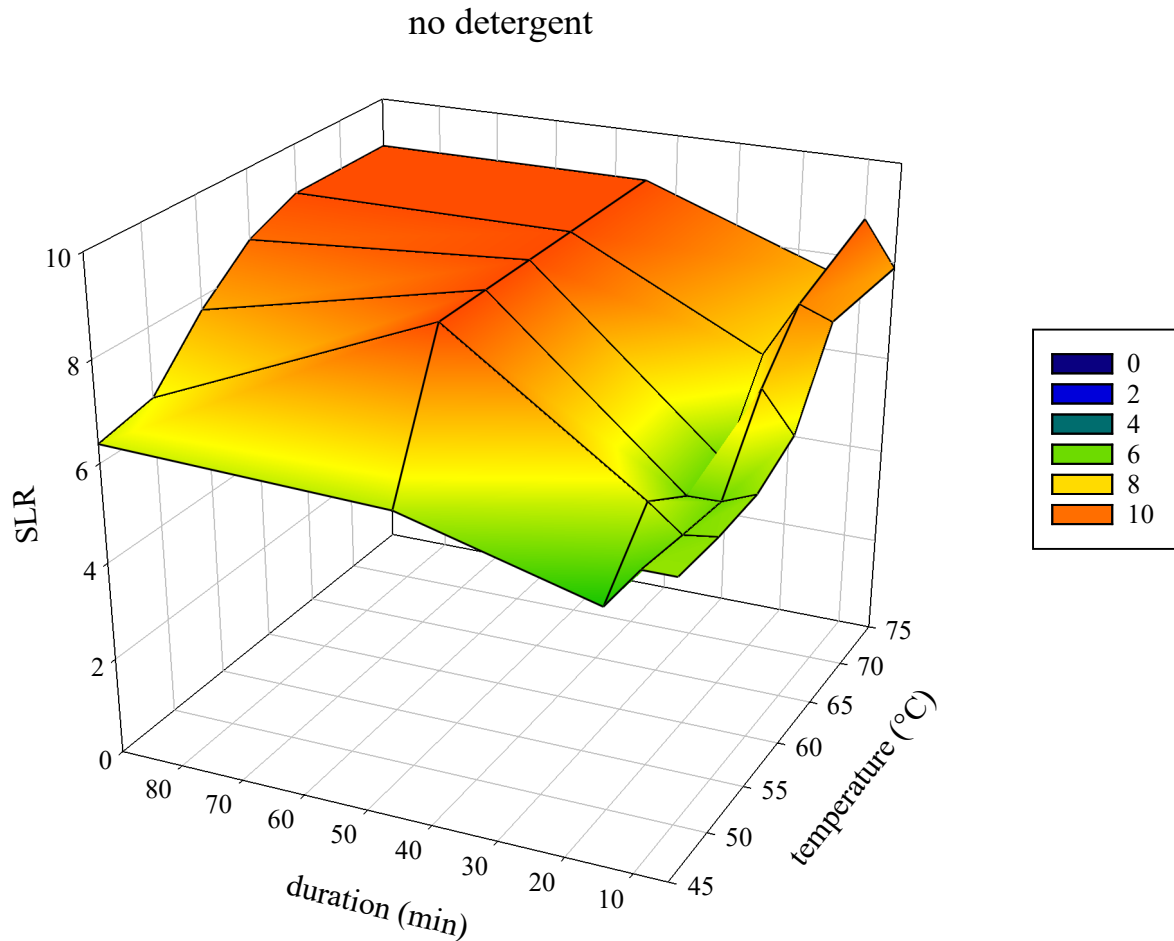

**Figure 55: Standardized logarithmic reduction (SLR) in the dishwasher depending on temperature and duration of the cleaning cycle. SLRs of cycles without detergent are shown.**

The addition of bleach-free detergent to the test system (Figure 56) generally led to higher reductions when the maximum reduction was not already reached without detergent. Maximum reduction was reached with lower temperatures. The small decrease observed at a temperature of 60 °C and a duration of 15 min compared to lower temperatures is due to a higher standard deviation.

Again, the higher reductions in the cycles with short cleaning durations of 5 min and 10 min at the low temperatures of 45 °C and 50 °C were unexpected. As mentioned before, this could be an initial washing-off effect in those short cycles, before the microbial load is redistributed in the system together with the water spread by the spray-arms when relatively low temperatures are applied.

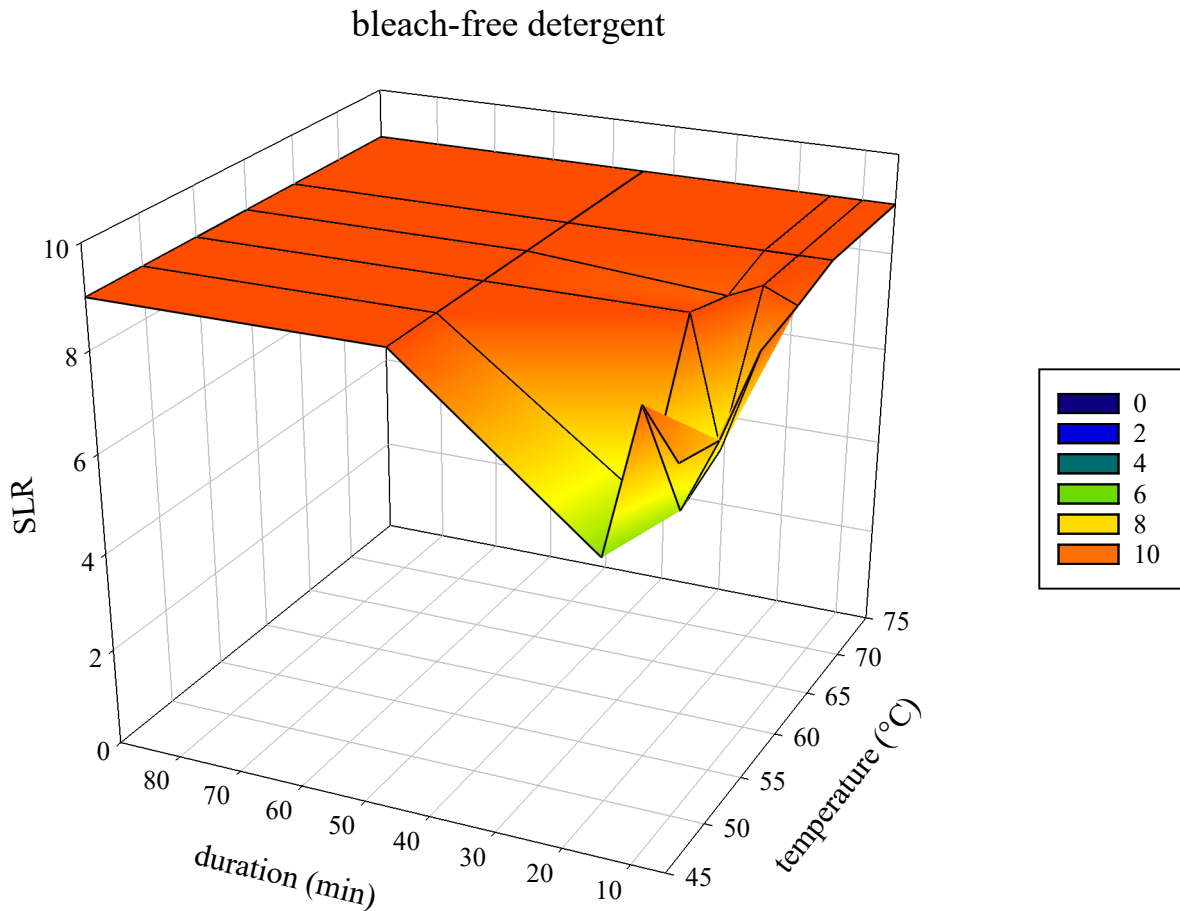
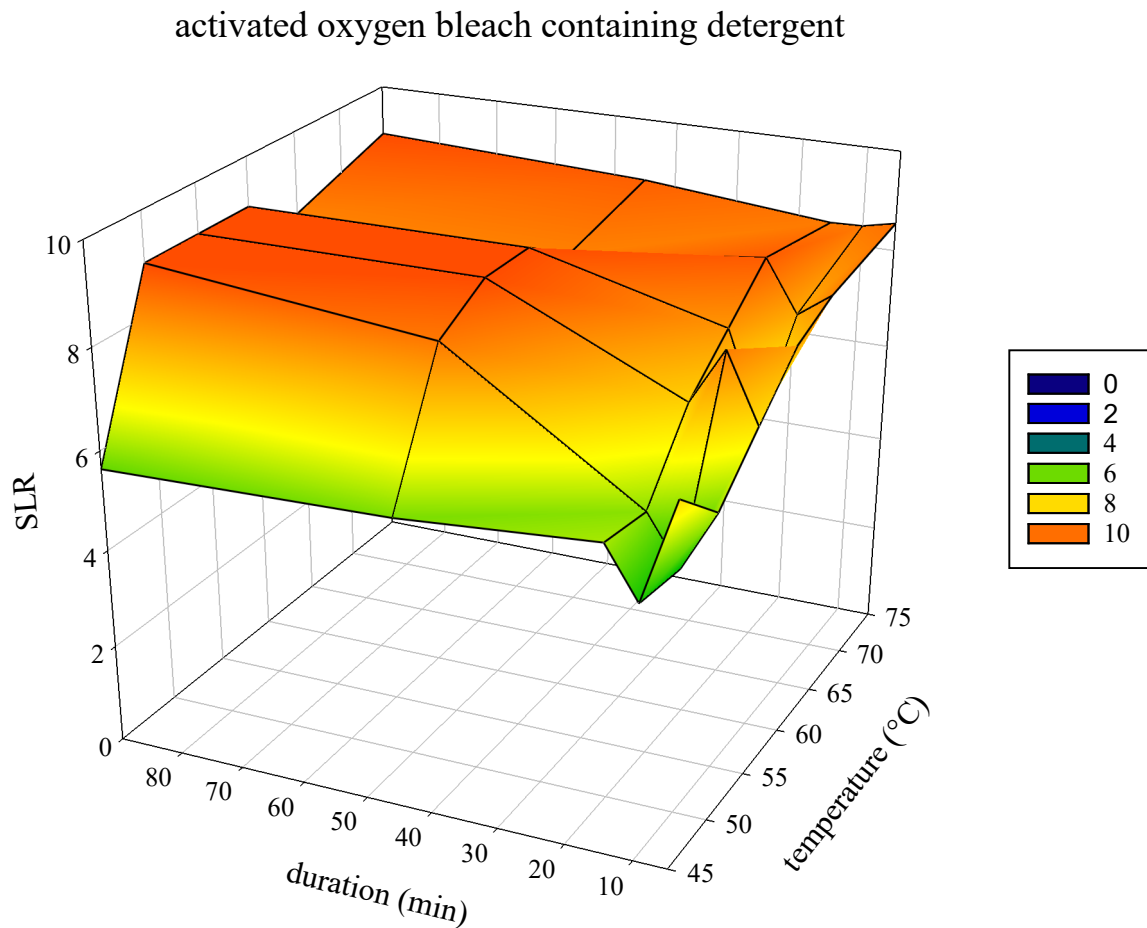

**Figure 56: Standardized logarithmic reduction (SLR) in the dishwasher depending on temperature and duration of the cleaning cycle. SLRs of cycles with bleach-free detergent are shown.**

In the tests with AOB-containing detergent (Figure 57), additional to the high reduction at the tests with 45 °C, 50 °C, 60 °C, 65 °C and 75 °C and a cleaning duration of 5 min, there is a remarkable dip in the reductions observed in tests with temperatures of 65 °C and durations of 45 min and 90 min. While the issue of high standard deviations may be the explanation for the reductions in the cycles with very short durations, the dip in the 65 °C cycles could be due to different lots of the reference detergent.

It has been discovered lately that the reference detergent provided by the supplier “wfk test materials” differs from the standard in the enzymes used. This composition might result in lower cleaning efficacy and thus might also be responsible for the lower reductions (personal communication with working group). Most of the test cycles have been performed with standard detergent mixed by Henkel, but the 65 °C cycles with the longer durations and most of the

15 min cycles have been performed with a lot delivered by wfk test materials. The lower reductions could result from the differences in the composition, but to what extent differences occur remains as yet unknown.

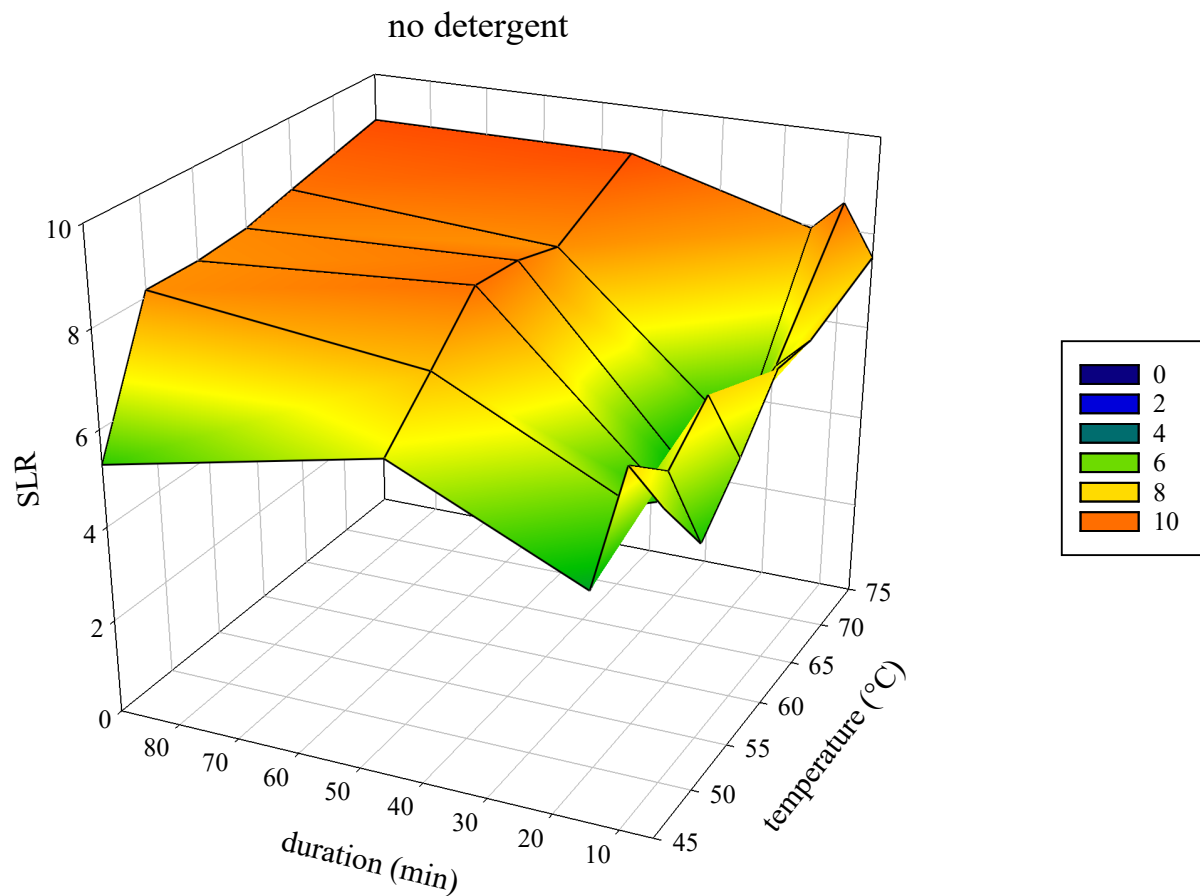

**Figure 57: Standardized logarithmic reduction (SLR) in the dishwasher depending on temperature and duration of the cleaning cycle. SLRs of cycles with activated oxygen-bleach (AOB)-containing detergent are shown.**

The reductions achieved with *M. luteus* DSM 1790 in cycles without detergent do also show lower reductions in the test cycles with a duration of 15 min compared to the 5 min and 10 min cycles (see Figure 58). As this was also observed with the *Ent. faecium* DSM 2146 biomonitors, this suggests for some yet undetected differences in the cycles. Whether these are to look for in the 15 min cycles or the shorter cycles, should be examined in future research.

Here, the microbial load of the water should be monitored in short intervals during cleaning cycles with different durations to investigate whether a washing-off effect or a redistribution

effect can be identified. Additionally, in these investigations, a number of sterile biomonitors should be included to detect a possible transmission of the microbial load to other surfaces.



**Figure 58: Standardized logarithmic reduction (SLR) in the dishwasher depending on temperature and duration of the cleaning cycle. SLRs of cycles without detergent are shown.**

The cycles with bleach-free detergent (Figure 59) nicely show the dependence of the achieved reductions on temperature and duration of the dishwashing cycle. Here, the small dip observed with the combination of 65 °C and 10 min compared to the 5 min and 15 min reductions is within the range of the standard deviations.

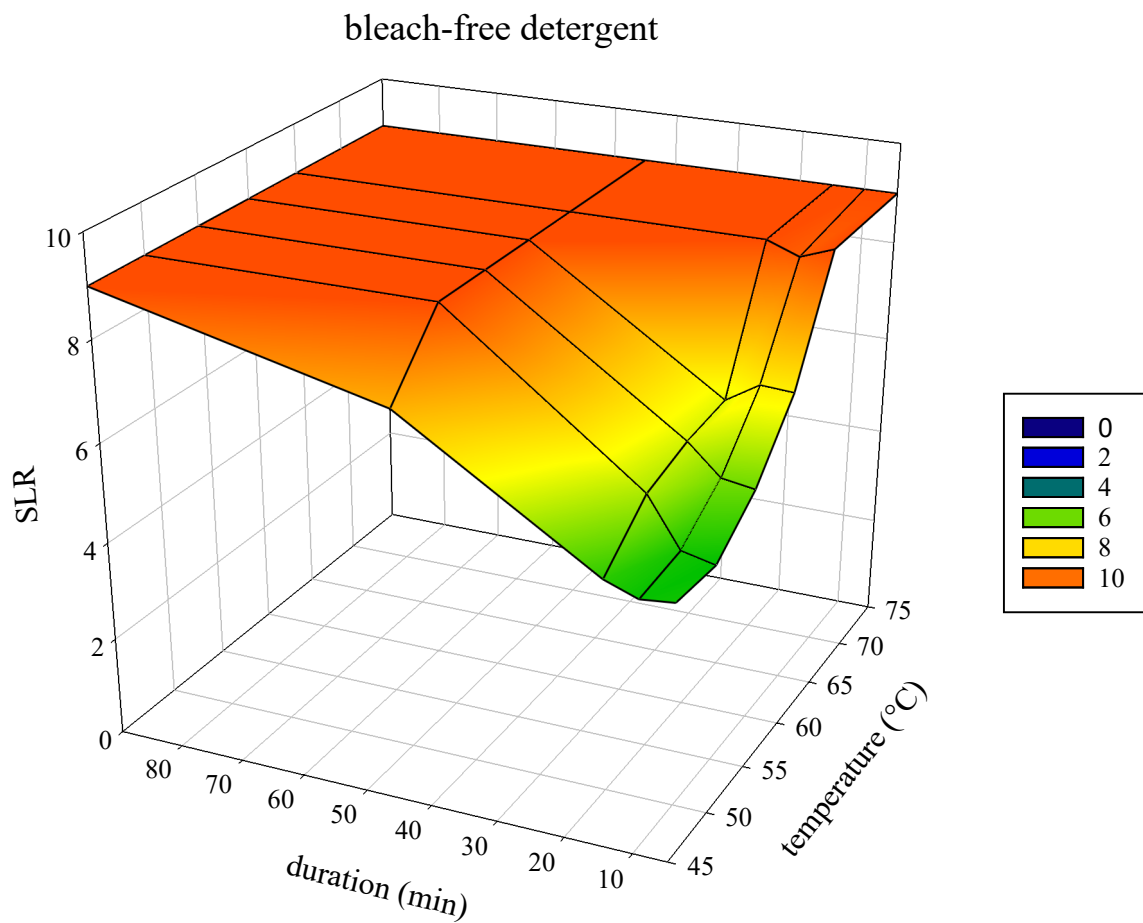

**Figure 59: Standardized logarithmic reduction (SLR) in the dishwasher depending on temperature and duration of the cleaning cycle. SLRs of cycles with bleach-free detergent are shown.**

When the cycles with AOB-containing detergent are analysed (Figure 60), the cycles with durations of 15 min again show lower reductions compared to the cycles with durations of 10 min and 45 min. A possible explanation for this is the use of different lots of reference detergent D as already mentioned with the *Ent. faecium* DSM 2146 biomonitors.

activated oxygen bleach containing detergent

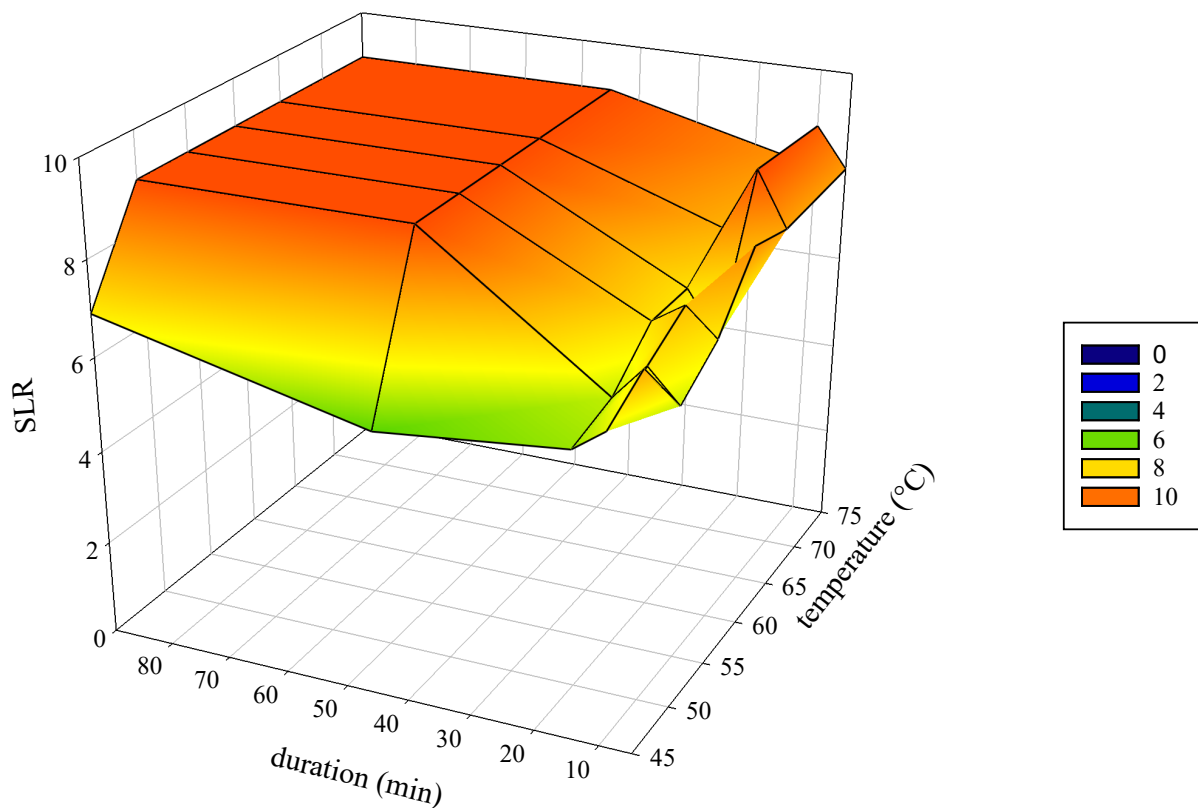

**Figure 60: Standardized logarithmic reduction (SLR) in the dishwasher depending on temperature and duration of the cleaning cycle. SLRs of cycles with activated oxygen-bleach (AOB)-containing detergent are shown.**

Another possible explanation for the phenomena observed might be the soil matrix. Even though the soil matrix is made following the same recipe and is made by the same person, the viscosity of the starch component can change quite abruptly. Thus, the viscosity and the removal can differ between batches and it cannot be excluded that the biomonitors differed between the different conditions. This has been examined with a small number of biomonitors as mentioned in 4.6. The results there suggest that the consistency of the soil matrix has an influence on the reduction.

On the other hand, the phenomenon of a few relatively high reductions in test cycles with shorter durations and/ or lower temperatures was observed with biomonitors with different test organisms and tests without detergent and bleach-free detergent from different lots.



This contradicts the idea of a matrix influence as sole factor for this phenomenon but together with the higher standard deviations compared to the cycles with longer durations rather suggests that there might be other influences in the shorter cycles. This might be due to the position of the spray arms at the beginning of the cycle and the resulting duration of the water jet with the respective biomonitor. This might also be different depending on the position of the biomonitor in the dishwasher.

More research is needed to further investigate these aspects. Some initial tests have been performed with biomonitors prepared in different laboratories in a first small round robin test series. There seem to be differences in the reduction between the laboratories and the viscosity of the starch component of BAMS clearly was different in the different laboratories. Whether the differences are caused by this alone or in combination with other factors such as the position in the dishwasher is not resolved yet.

The preparation of the starch component has been redefined to give an indication of the desired viscosity based on the results of the first round-robin tests.

### **5.8. Quantity of ballast soil**

In the dishwasher tests, frozen ballast soil with a composition according to IEC 60436 was used (International Electrotechnical Commission, 2015). A portion of 100 g frozen ballast soil was situated in a mug in the upper rack in each test cycle. The soil load that has been detected in consumer studies, varies between 0.6 g and 74.8 g with a mean soil level of 7.3 g in households that pre-rinse dishes before loading them into the dishwasher and 12 g without pre-rinsing (Hubbuck and Goodall, 1999).

The amount of soil used in the tests is thus 8.3 times higher than the mean detected load. High soil levels decrease the reduction in laundering processes (Block *et al.*, 2001; Bockmühl, 2017).

This, combined with the high amount of ballast soil present in the tests suggests that the received reductions could be viewed as a kind of worst-case-scenario with higher possible reductions at reduced soil levels.

It would be interesting to evaluate the influence of different soil levels in the dishwasher in the future, as the soil levels in laundering tests and in the suspension-tests have shown to influence the achieved reductions.

### **5.9. Temperature profiles in automated dishwashers**

All the dishwasher tests have been performed in a reference automated dishwasher. For this dishwasher, special programmes with fixed rinsing temperatures and different cleaning temperatures and durations have been developed and used. The appliance uses an amount of 14 L water per tests cycle. Other appliances use programmes with different temperature profiles. A few examples recorded in a typical market appliance produced in 2014 are given in Figure 61.

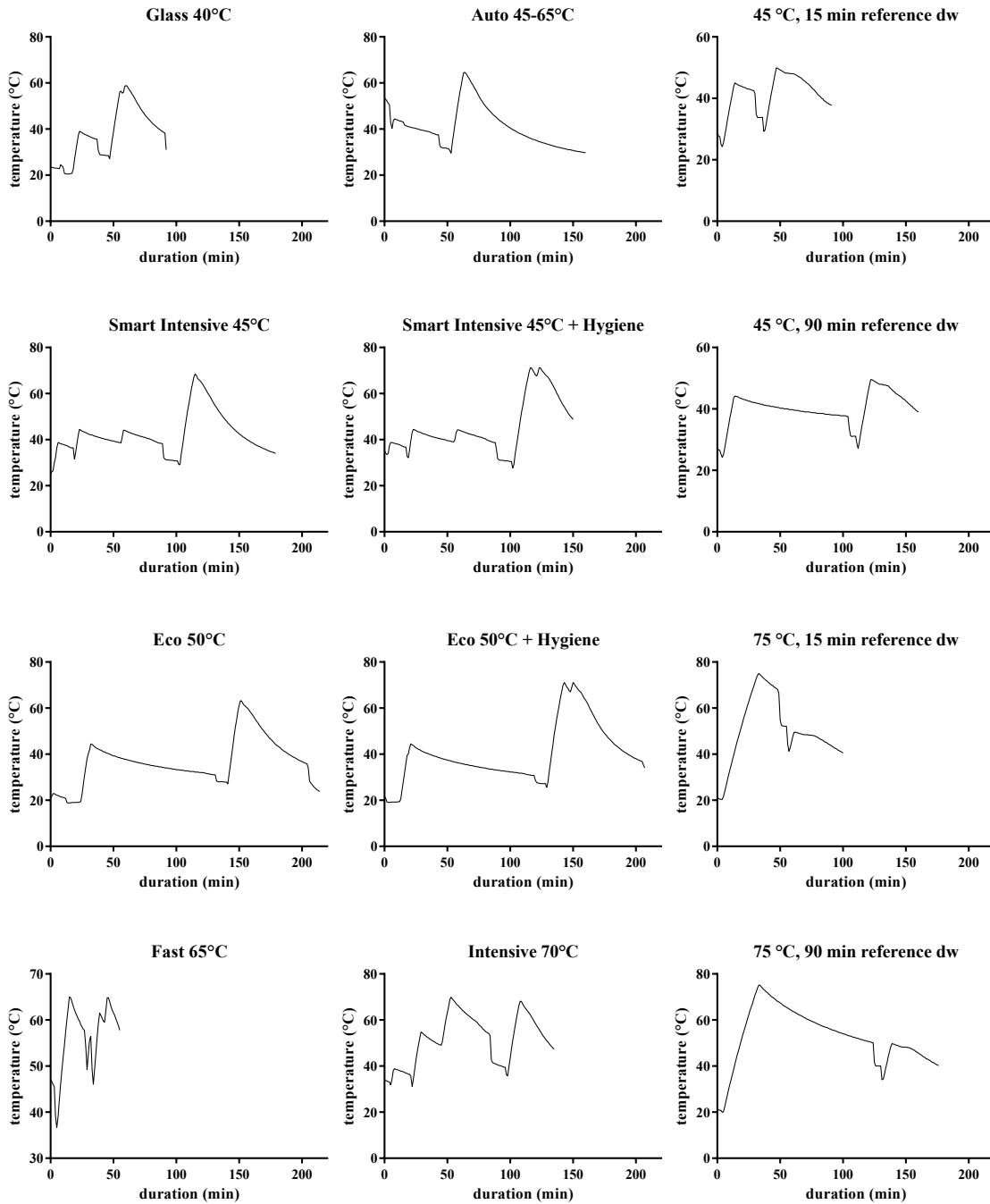

**Figure 61: Temperature profiles of different dishwasher cycles.**

These temperature profiles were recorded in one typical market dishwasher and the reference appliance used in the tests. It is obvious that the different programmes do show huge varieties in the temperatures reached, the duration of the cleaning cycles and the number of different rinsing cycles applied.

The tests so far have all been carried out in the reference dishwasher (diagrams on the right) with fixed durations and nominal temperatures between 45 °C and 75 °C in the main cleaning cycle. Here, no pre-rinsing was used. All cycles show an initial influx of water, followed by the heating phase. The recorded “smart” programmes show an initial pre-rinsing with lower temperature, followed by the heating phase to the nominal temperature.

Other cycles, as the “hygiene” cycles show increased rinsing temperatures and double heating steps. All these differences have an influence on the detected LR. For example, the reduction measured on polypropylene pieces artificially contaminated with *Salmonella* Typhimurium or *Staphylococcus aureus* cleaned in the appliance resulted in LRs ranging from 3.87 using the Eco 50 °C programme to complete reductions (> 5.1) reached in the 40 °C glass programme (Amon, 2015).

The differences in the temperature profiles and the reductions achieved with different microbial strains makes it nearly impossible to predict the reductions that are reached in the tests and thus justify the testing in the actual device.

### 5.10. Relevance

It was shown that the microbial load of artificially contaminated biomonitors is reduced to different extents in automated dishwashers for household use. The extent of this reduction depends on the combination of the appliance, the selected cleaning cycle, the chosen temperature, the detergent used and the microbial strain investigated.

Although thus far tests have shown, that the microbial load on the cleaned goods is generally good with only very few microorganisms detected by contact plates (Brands and Bockmühl, 2015), but that reduced cleaning and drying temperatures can impair the reduction rates (Brands *et al.*, 2016b).

Although there are attempts to predict the reduction efficiency of dishwasher cycles based on relatively few tests cycles in the respective appliance with the MIE-concept (Schulze Struchtrup *et al.*, 2020), the results are not to be used in other appliances or for cleaning cycles with different temperature profiles.

As the heating of the water costs most of the energy used in the cleaning cycle and the regulations for the energy label are getting stricter, the standard programmes are at risk to operate at lower temperatures.

The changes in the calculation for the energy label will lead to a shift in the energy efficiency classes. For example, a device with 14 place settings that uses  $0.75 \text{ kWh} \cdot \text{cycle}^{-1}$  and has a yearly energy consumption of 213 kWh currently reaches a classification of A+++. From March 2021, that same device would be rated into energy efficiency class D.

To reach a higher energy efficiency class, it would be an option to use more effective heating devices or to lower the temperature and save the energy used for heating of the water.

A reduction of the temperatures below critical values either in the cleaning or the rinsing cycle could lead to increased remaining loads on the cleaned tableware. While this might not be a problem under most circumstances, especially in households with risk groups the rise of the microbial load could lead to the survival of a critical number of microorganisms and these in turn could cause infections.

This is especially important for microorganisms that have very low infectious doses or could cause severe symptoms in the infected person.

Here, it is important for those risk groups to either use cycles with higher cleaning temperatures to make sure to keep the remaining number of microorganisms below a critical limit. This can be achieved by the use of special hygiene cycles on a regular basis (Brands *et al.*, 2016b; Brands and Bockmühl, 2015).

It is very important to keep the balance between the reduction of the energy use and the necessary hygiene, especially in circumstances with special needs.

### 5.11. Future prospects

The current study has shown the complexity in the development of a method to identify the parameters affecting the microbial reduction in domestic dishwashers.

The alternative test strain *M. luteus* DSM 1790 has been tested alongside with the established test strain *Ent. faecium* DSM 2146. It has shown similar behaviour and sometimes showed even better differentiation between the chosen test parameters.

It would be of interest to broaden the spectrum and test some additional Gram-negative strains for their resistance in initial suspension tests and maybe include some yeasts belonging to BSL1. This would in the one hand cover a broader spectrum of possible contaminants and on the other hand also deal with the possibly different behaviour of microorganisms caused by different compositions of their outer membranes.

An optimization or better understanding of the LR differences observed with the established biomonitors between the different laboratories would be the next logical step. First ideas for future experiments were already collected: The dependency of the reduction on the number of cleaning cycles will be investigated in the near future. This might deliver the explanation of the different LRs detected on biomonitors prepared at different laboratories. If the results will not give an explanation, a stricter regulation of the soil matrix BAMS and especially of the viscosity of the starch solution might be necessary.

The oatmeal soil matrix used by Zinn *et al.* (Zinn *et al.*, 2018) might also be interesting and the reductions seemed to be generally lower in initial tests in household dishwashers, but the number of results is too low to give a profound statement on that topic.

The systematic investigation of the influence factors in the used reference dishwasher have shown that temperature and duration of the cleaning cycle did contribute most to the observed reductions achieved here. The next logical step would be to investigate the results obtained in typical market appliances and with typical market detergents.

## 6. Conclusion

Cleaning and rinsing temperature, cleaning duration and the detergent used determine the microbial reduction in the domestic dishwasher. The influence of the single factor cannot be investigated separated from the other factors as the different factors do interact and in some combinations even cause each other. When the temperature is lifted, the duration of the dishwasher cycle increases as more time is needed to heat the water.

These factors influenced the reduction of the different test strains used to different extents. While for all of the investigated food related Gram-negative test strains as *Salmonella* Typhimurium, *Campylobacter jejuni*, *Pseudomonas aeruginosa* and *Escherichia coli*, even the lowest temperatures led to total reductions in the dishwasher, Gram-positive test strains like *Micrococcus luteus*, *Enterococcus faecium*, *Staphylococcus aureus* and *Bacillus subtilis* were tested to be more resistant in either dishwasher tests or suspension tests. As the tested Gram-negative strains were chosen from a rather small group, strains from other groups of Gram-negative bacteria should be tested to possibly include them in a later version of the standard to cover a broader range of microorganisms.

While tests with the known test strains *Ent. faecium* DSM 2146 and *S aureus* DSM 939 would be restricted to laboratories with an BSL2 allowance, *M. luteus* DSM 1790 and *B. subtilis* DSM 10<sup>T</sup> would be possible to test in all laboratories with basic microbiology equipment and knowledge. As *M. luteus* DSM 1790 has shown a similar heat resistance and reduction behaviour as the well-known strain *Ent. faecium* DSM 2146, this replacement of the hitherto used BSL2 strain by a BSL1 strain would be possible

Working with *B. subtilis* DSM 10<sup>T</sup> revealed the problem of spore formation and spores being unresponsive to the test parameters in the dishwasher, so *M. luteus* DSM 1790 remained as test strain that fulfils the requirements to be easy to identify due to the colour, not being restricted to laboratories with a BSL2 allowance due to the BSL1 classification and at the same differentiate between different test conditions.

Although the established method is not at its optimum yet, as for example the reductions on biomonitors from different laboratories are not identical, it provides a base to compare the effect of different parameter combinations at least within one laboratory.

With improvements on the biomonitor production and ideas to evaluate the reductions found in round robin tests, it can provide a simple yet effective means to evaluate the impact of the different washing factors.

## 7. References

- Amberg, C., (2018). Microbial Reduction in Low Temperature Dishwashing Cycles. *Tenside, Surfactants, Deterg.* 55, 383–390.
- Amon, V., (2015). Vergleichende Analyse des Einflusses verschiedener Materialien auf die Persistenz lebensmittelrelevanter Bakterien und Reinigung kontaminierter Schneidebretter. Bachelorarbeit der Hochschule Rhein-Waal.
- Andrade, N.J., Bridgeman, T.A., Zottola, E.A., (1998). Bacteriocidal activity of sanitizers against *Enterococcus faecium* attached to stainless steel as determined by plate count and impedance methods. *J. Food Prot.* 61, 833–838. <https://doi.org/10.4315/0362-028X-61.7.833>
- ATCC, (2020). *Micrococcus luteus* [WWW Document]. URL [https://www.lgcstandards-atcc.org/Products/All/10240.aspx?geo\\_country=de#generalinformation](https://www.lgcstandards-atcc.org/Products/All/10240.aspx?geo_country=de#generalinformation) (accessed 2.2.20).
- Ausschuss für Biologische Arbeitsstoffe, (2016). Technische Regeln für Biologische Arbeitsstoffe (TRBA) 460 - Einstufung von Pilzen in Risikogruppen. Gemeinsames Minist. GMBI 2016, 1–55.
- Ausschuss für Biologische Arbeitsstoffe, (2018). Technische Regeln für Biologische Arbeitsstoffe (TRBA) 466 „Einstufung von Prokaryonten (Bacteria und Archaea) in Risikogruppen“.
- Babič, M.N., Gunde-Cimerman, N., Vargha, M., Tischner, Z., Magyar, D., Veríssimo, C., Sabino, R., Viegas, C., Meyer, W., Brandão, J., (2017a). Fungal contaminants in drinking water regulation? A tale of ecology, exposure, purification and clinical relevance. *Int. J. Environ. Res. Public Health* 14. <https://doi.org/10.3390/ijerph14060636>
- Babič, M.N., Zalar, P., Zenko, B., Schroers, H.-J., Dzeroski, S., Gunde-Cimerman, N., (2015). *Candida* and *Fusarium* species known as opportunistic human pathogens from customer-accessible parts of residential washing machines. *Fungal Biol.* 119, 95–113. <https://doi.org/10.1016/j.funbio.2014.10.007>
- Babič, M.N., Zupančič, J., Gunde-Cimerman, N., de Hoog, S., Zalar, P., (2017b). Ecology of the Human Opportunistic Black Yeast *Exophiala dermatitidis* Indicates Preference for Human-Made Habitats. *Mycopathologia* 1–12. <https://doi.org/10.1007/s11046-017-0134-8>
- Bährle-Rapp, M., (2012). H, in: Springer Lexikon Kosmetik Und Körperpflege. Springer Berlin



- Heidelberg, Berlin, Heidelberg, pp. 246–288. [https://doi.org/10.1007/978-3-642-24688-3\\_8](https://doi.org/10.1007/978-3-642-24688-3_8)
- Baird-Parker, A.C., (1965). The Classification of Staphylococci and Micrococci from Worldwide Sources. *J. Gen. Microbiol.* 38, 363–387. <https://doi.org/10.1099/00221287-38-3-363>
- Bansal, P., Vineyard, E., Abdelaziz, O., (2011). Advances in household appliances- A review. *Appl. Therm. Eng.* 31, 3748–3760. <https://doi.org/10.1016/j.applthermaleng.2011.07.023>
- Bartelt, E., Sipos, G., Klein, G., (2008). Mikrobiologie der Fische und Fischereierzeugnisse, in: Weber, H. (Ed.), *Fleisch - Fisch - Feinkost*. Behr, Hamburg, pp. 677–718.
- Bast, E., (2014). *Mikrobiologische Methoden. Eine Einführung in grundlegende Arbeitstechniken*, 2nd ed. Springer Spektrum.
- Bauer, A., Østensvik, Ø., Florvåg, M., Ørmen, Ø., Rørvik, L.M., (2006). Occurrence of *Vibrio parahaemolyticus*, *V. cholerae*, and *V. vulnificus* in Norwegian Blue Mussels (*Mytilus edulis*). *Society* 72, 3058–3061. <https://doi.org/10.1128/AEM.72.4.3058>
- Baumgart, J.H., (2004). *Mikrobiologische Untersuchung von Lebensmitteln*, 38. Lfg. als LBA Mikrothek. Behr, Hamburg.
- Berger, S., Stamminger, R., Schünemann, W.M., Lipski, A., (2015). Development of a Method for the Analysis of Microbial Load Reduction Factors on Dishes Cleaned by Hand and by Machine. *Tenside Surfactants Deterg.* 52, 206–212. <https://doi.org/10.3139/113.110367>
- Berkholz, P., Stamminger, R., Wnuk, G., Owens, J., Bernarde, S., (2010). Manual dishwashing habits: an empirical analysis of UK consumers. *Int. J. Consum. Stud.* 34, 235–242. <https://doi.org/10.1111/j.1470-6431.2009.00840.x>
- Betts Gail D., V., Everis Linda, V., (2007). *Microbial spoilage of foods a review*. Campden & Chorleywood Food Research Assoc., Chipping Campden.
- Betz, M.M., (2001). *Antimikrobielle Wirksamkeit von Bleichmitteln und Bleichsystemen*. Technische Universität München. <https://doi.org/not available>
- bioMérieux, (2016). Ref 21342 VITEK (R) 2 GP.
- Bird, M.R., Fryer, P.J., (1991). An experimental study of the cleaning of surfaces fouled by whey proteins. *Food Bioprod. Process.* 69c, 13–21.
- Blackmore, M.A., Howard, K., Prisk, E.M., Staddon, M., (1983). A Comparison of the

- Efficiency of Manual and Automatic Dishwashing for the Removal of Bacteria from Domestic Crockery. *J. Consum. Stud. Home Econ.* 7, 25–29. <https://doi.org/10.1111/j.1470-6431.1983.tb00085.x>
- Blattman, E., (2013). Three Every-day items invented by women [WWW Document]. *Natl. Women's Hist. Museum*. URL <https://www.womenshistory.org/articles/three-every-day-items-invented-women> (accessed 1.6.20).
- Block, C., Bosch, C., Hartog, B., Lemaire, P., Stelter, N., (2001). Determination of the microbicidal effect of laundry detergents. *Tenside Surfactants Deterg.* 38, 140–146.
- Bloomfield, S.F., (1978). The Use of Disinfectants in the Home. *J. Appl. Bacteriol.* 45, 1–38. <https://doi.org/10.1111/j.1365-2672.1978.tb04195.x>
- Bockmühl, D.P., (2017). Laundry hygiene — how to get more than clean. *J. Appl. Microbiol.* 1–10. <https://doi.org/10.1111/jam.13402>
- Bollen, C.M., Lambrechts, P., Quirynen, M., (1997). Comparison of surface roughness of oral hard materials to the threshold surface roughness for bacterial plaque retention: a review of the literature. *Dent. Mater.* 13, 258–269. [https://doi.org/10.1016/s0109-5641\(97\)80038-3](https://doi.org/10.1016/s0109-5641(97)80038-3)
- Bradley, C.R., Fraise, A.P., (1996). Heat and chemical resistance of enterococci. *J. Hosp. Infect.* 34, 191–196. [https://doi.org/10.1016/S0195-6701\(96\)90065-1](https://doi.org/10.1016/S0195-6701(96)90065-1)
- Brands, B., Bockmühl, D.P., (2015). Experimental Evaluation of Hygienic Conditions in Domestic Dishwashers. *Tenside Surfactants Deterg.* 52, 148–154. <https://doi.org/10.3139/113.110360>
- Brands, B., Brinkmann, A., Bloomfield, S.F., Bockmühl, D.P.D.P.D.P.D.P., (2016a). Microbicidal Action of Heat, Detergents and Active Oxygen Bleach as Components of Laundry Hygiene. *Tenside Surfactants Deterg.* 53, 495–501. <https://doi.org/10.3139/113.110464>
- Brands, B., Honisch, M., Merettig, N., Bichler, S., Stamminger, R., Kinnius, J., Seifert, M., Hardacker, I., Kessler, A., Weide, M., Wrubbel, N., Bockmühl, D.P., (2016b). Qualitative and Quantitative Analysis of Microbial Communities in Household Dishwashers in Germany. *Tenside Surfactants Deterg.* 53, 112–118. <https://doi.org/10.3139/113.110415>
- Breiman, L., (2001). Random forests. *Mach. Learn.* 45, 5–32. <https://doi.org/10.1023/A:1010933404324>

- Brückner, A., Stamminger, R., (2014). Consumer-relevant assessment of automatic dishwashing machines by a new testing procedure for ???automatic??? programmes. *Energy Effic.* 8, 171–182. <https://doi.org/10.1007/s12053-014-9284-4>
- Buergers, R., Rosentritt, M., Handel, G., (2007). Bacterial adhesion of *Streptococcus mutans* to provisional fixed prosthodontic material. *J. Prosthet. Dent.* 98, 461–469. [https://doi.org/10.1016/S0022-3913\(07\)60146-2](https://doi.org/10.1016/S0022-3913(07)60146-2)
- Bundesinstitut für Risikobewertung, (2015). Sicher verpflegt, Besonders empfindliche Personengruppen in Gemeinschaftseinrichtungen. BfR 1–8.
- Carballo, J., Araùjo, A.-B., (2012). Evaluation of the efficacy of commercial sanitizers against adhered and planktonic cells of *Listeria monocytogenes* and *Salmonella* spp. *Ciência e Technol. Aliment.* 2012, 606–612.
- Cochran, J.G., (1886). Dish Washing Machine Patent US355139A.
- Cogan, T.A., Slader, J., Bloomfield, S.F., Humphrey, T.J., (2002). Achieving hygiene in the domestic kitchen: The effectiveness of commonly used cleaning procedures. *J. Appl. Microbiol.* 92, 885–892. <https://doi.org/10.1046/j.1365-2672.2002.01598.x>
- Cole, R.J., Cox, R.H., (1981). Handbook of Toxic Fungal Metabolites, Handbook of Toxic Fungal Metabolites. Elsevier. <https://doi.org/10.1016/C2009-0-03073-6>
- Coleman, W.H., Chen, D., Li, Y.Q., Cowan, A.E., Setlow, P., (2007). How moist heat kills spores of *Bacillus subtilis*. *J. Bacteriol.* 189, 8458–8466. <https://doi.org/10.1128/JB.01242-07>
- Commission Delegated Regulation (EU), (2010). Commission Delegated Regulation (EU) No 1059/2010 of 28 September 2010 supplementing Directive 2010/30/EU of the European Parliament and of the Council with regard to energy labelling of household dishwashers. *Off. J. Eur. Union* 53, 1–16. [https://doi.org/10.3000/17252555.L\\_2010.314.eng](https://doi.org/10.3000/17252555.L_2010.314.eng)
- Commission Delegated Regulation (EU), (2019). COMMISSION DELEGATED REGULATION (EU) supplementing Regulation (EU) 2017/1369 of the European Parliament and of the Council with regard to energy labelling of refrigerating appliances and repealing Commission Delegated Regulation (EU) No 1060/2010. *Off. J. Eur. Union* 62, 134–154.
- Corry, J.E.L., (2007a). 5 - Spoilage organisms of red meat and poultry, in: Mead, G.C. (Ed.), *Microbiological Analysis of Red Meat, Poultry and Eggs*, Woodhead Publishing Series in

- Food Science, Technology and Nutrition. Woodhead Publishing, pp. 101–122.  
<https://doi.org/https://doi.org/10.1533/9781845692513.101>
- Corry, J.E.L., (2007b). 9 - Microbiological analysis of eggs and egg products, in: Mead, G.C. (Ed.), *Microbiological Analysis of Red Meat, Poultry and Eggs*, Woodhead Publishing Series in Food Science, Technology and Nutrition. Woodhead Publishing, pp. 183–201.  
<https://doi.org/https://doi.org/10.1533/9781845692513.183>
- Costa de Medeiros Dantas, L., Paulo da Silva-Neto, J., Souza Dantas, T., Zago Naves, L., Domingues das Neves, F., Soares da Mota, A., (2016). Bacterial adhesion and surface roughness for different clinical techniques for acrylic polymethyl methacrylate. *Int. J. Dent.* 2016, 1–6.
- Cypionka, H., (2010). *Grundlagen der Mikrobiologie*, Springer-Lehrbuch. Springer Berlin Heidelberg, Berlin, Heidelberg. <https://doi.org/10.1007/978-3-642-05096-1>
- Daly, K.N., Rengel, M., (2009). *Greek and Roman mythology, A to Z*. Chelsea House Publishers.
- Darker, G.D., Brown, H.B., Free, A.H., Biro, B., Goorley, J.T., Free, A.H., (1948). The assay of bacitracin. *J. Am. Pharm. Assoc. (Scientific ed.)* 37, 156–160.  
<https://doi.org/10.1002/jps.3030370409>
- Das Europäische Parlament und der Rat der Europäischen Union, (2004). Verordnung (EG) Nr. 853/2004 des EUROPÄISCHEN PARLAMENTS und des RATES vom 29. April 2004 mit spezifischen Hygienevorschriften für Lebensmittel tierischen Ursprungs.
- Delahunty, A., Dignen, S., (2010). *The Oxford Dictionary of Reference and Allusion*, The Oxford Dictionary of Reference and Allusion. Oxford University Press.  
<https://doi.org/10.1093/acref/9780199567454.001.0001>
- Demilly, M., Bréchet, Y., Bruckert, F., Boulangé, L., (2006). Kinetics of yeast detachment from controlled stainless steel surfaces. *Colloids Surfaces B Biointerfaces* 51, 71–79.  
<https://doi.org/10.1016/j.colsurfb.2006.05.007>
- Demšar, J., Curk, T., Erjavec, A., Gorup, Č., Hočevar, T., Milutinovič, M., Možina, M., Polajnar, M., Toplak, M., Starič, A., Štajdohar, M., Umek, L., Žagar, L., Žbontar, J., Žitnik, M., Zupan, B., (2013). Orange: Data Mining Toolbox in Python. *J. Mach. Learn. Res.* 14, 2349–2353.
- Deutsches Institut für Normung e. V., (1999). DIN 10511-1999 Gewerbliches Gläserspülen mit

Gläsererspülmaschinen - Hygienische Anforderungen, Prüfungen 1–20.

Deutsches Institut für Normung e. V., (2005). DIN EN ISO 15883-1:2014-10 Washer-disinfectors – Part 1: General requirements, terms and definitions and tests (ISO 15883-1:2006 + Amd 1:2014); German version EN ISO 15883-1:2009 + A1:2014.

Deutsches Institut für Normung e. V., (2006a). DIN 10522:2006 - Gewerbliches maschinelles Spülen von Mehrwegkästen und Mehrwegbehältnissen für unverpackte Lebensmittel - Hygieneanforderungen, Prüfung.

Deutsches Institut für Normung e. V., (2006b). DIN EN 1275 - Chemische Desinfektionsmittel und Antiseptika – Quantitativer Suspensionsversuch zur Bestimmung der fungiziden oder levuroziden Wirkung (Basistest) chemischer Desinfektionsmittel und Antiseptika – Prüfverfahren und Anforderungen (Phase 1). <https://doi.org/not available>

Deutsches Institut für Normung e. V., (2006c). DIN EN 1040 - Chemische Desinfektionsmittel und Antiseptika – Quantitativer Suspensionsversuch zur Bestimmung der bakteriziden Wirkung (Basistest) chemischer Desinfektionsmittel und Antiseptika – Prüfverfahren und Anforderungen (Phase 1). <https://doi.org/not available>

Deutsches Institut für Normung e. V., (2008). DIN 10512:2008 Lebensmittelhygiene - Gewerbliches Geschirrspülen mit Eintank-Geschirrspülmaschinen - Hygienische Anforderungen, Typprüfung. Beuth Verlag.

Deutsches Institut für Normung e. V., (2009). DIN 10516 Food hygiene – Cleaning and disinfection. Berlin.

Deutsches Institut für Normung e. V., (2012). DIN EN 13697: Chemical disinfectants and antiseptics – Quantitative non-porous surface test for the evaluation of bactericidal and/or fungicidal activity of chemical disinfectants used in food, industrial, domestic and institutional areas – Test method an.

Deutsches Institut für Normung e. V., (2013). DIN 10510:2013 - Lebensmittelhygiene - Gewerbliches Geschirrspülen mit Mehrtank-Transportgeschirrspülmaschinen - Hygienische Anforderungen, Verfahrensprüfung. Beuth Verlag.

Deutsches Institut für Normung e. V., (2014). DIN EN 10088-3:2014-12 Nichtrostende Stähle - Teil 3: Technische Lieferbedingungen für Halbzeug, Stäbe, Walzdraht, gezogenen Draht, Profile und Blankstahlerzeugnisse aus korrosionsbeständigen Stählen für allgemeine Verwendung. Beuth Verlag, Berlin.

- Deutsches Institut für Normung e. V., (2019). DIN SPEC 10534:2019-02 Lebensmittelhygiene – Gewerbliches maschinelles Spülen – Hygieneanforderungen, Prüfung. Beuth Verlag, Berlin. <https://doi.org/10.31030/3016249>
- Dinse, G.E., (2011). An EM Algorithm for Fitting a 4-Parameter Logistic Model to Binary Dose-Response Data. *J. Agric. Biol. Environ. Stat.* 16, 221–232. <https://doi.org/10.1007/s13253-010-0045-3>
- Dishwashers | European Commission [WWW Document], (2020). URL [https://ec.europa.eu/info/energy-climate-change-environment/standards-tools-and-labels/products-labelling-rules-and-requirements/energy-label-and-ecodesign/energy-efficient-products/dishwashers\\_en](https://ec.europa.eu/info/energy-climate-change-environment/standards-tools-and-labels/products-labelling-rules-and-requirements/energy-label-and-ecodesign/energy-efficient-products/dishwashers_en) (accessed 2.24.20).
- Döğen, A., Kaplan, E., Oksüz, Z., Serin, M.S., Ilkit, M., de Hoog, G.S., (2013). Dishwashers are a major source of human opportunistic yeast-like fungi in indoor environments in Mersin, Turkey. *Med. Mycol.* 51. <https://doi.org/10.3109/13693786.2012.738313>
- Dunn, O.J., (1961). Multiple Comparisons Among Means. *J. Am. Stat. Assoc.* 56, 52–64. <https://doi.org/10.2307/2282330>
- Ebner, W., Eitel, A., Scherrer, M., Daschner, F.D., (2000). Can household dishwashers be used to disinfect medical equipment? *J. Hosp. Infect.* 45, 155–159. <https://doi.org/10.1053/jhin.1999.0720>
- Fijan, S., Šostar-Turk, S., (2010). Antimicrobial activity of selected disinfectants used in a low temperature laundering procedure for textiles. *Fibres Text. East. Eur.* 78, 89–92.
- Fontes Parizzi, S.Q., De Andrade, N.J., De Sá Silva, C.A., Ferreira Soares, N.D.F., Monteiro Da Silva, E.A., (2004). Bacterial adherence to different inert surfaces evaluated by epifluorescence microscopy and plate count method. *Brazilian Arch. Biol. Technol.* 47, 77–83.
- Francis, J., Newsom, S.W.B., (1987). Evaluation of dishwashing machines in four hospitals. *J. Hosp. Infect.* 9, 294–297. [https://doi.org/10.1016/0195-6701\(87\)90128-9](https://doi.org/10.1016/0195-6701(87)90128-9)
- Frank, J.F., (2007). Milk and Dairy Products, in: *Food Microbiology: Fundamentals and Frontiers*, Third Edition. American Society of Microbiology, pp. 141–155.
- Fritsche, O., (2016). *Mikrobiologie*. Springer Berlin Heidelberg, Berlin, Heidelberg. <https://doi.org/10.1007/978-3-662-49729-6>
- García-Gimeno, R.M., Zurera-Cosano, G., (1997). Determination of ready-to-eat vegetable

- salad shelf-life. *Int. J. Food Microbiol.* 36, 31–38. [https://doi.org/10.1016/S0168-1605\(96\)01238-X](https://doi.org/10.1016/S0168-1605(96)01238-X)
- Gayral, J.P., Sandstedt, D., Guicherd, M., Cagnes, S., Cogne, R., Cuziat, R., (1997). Bacterial identification. *Clin. Microbiol. Infect.* 3, 53–56. <https://doi.org/10.1111/j.1469-0691.1997.tb00936.x>
- Giaouris, E., Samoilis, G., Chorianopoulos, N., Ercolini, D., Nychas, G., (2013). International Journal of Food Microbiology Differential protein expression patterns between planktonic and biofilm cells of *Salmonella enterica* serovar Enteritidis PT4 on stainless steel surface. *Int. J. Food Microbiol.* 162, 105–113. <https://doi.org/10.1016/j.ijfoodmicro.2012.12.023>
- Goode, K.R., Asteriadou, K., Robbins, P.T., Fryer, P.J., (2013). Fouling and cleaning studies in the food and beverage industry classified by cleaning type. *Compr. Rev. Food Sci. Food Saf.* 12, 121–143. <https://doi.org/10.1111/1541-4337.12000>
- Gough, N.L., Dodd, C.E.R., (1998). The survival and disinfection of *Salmonella typhimurium* on chopping board surfaces of wood and plastic. *Food Control* 9, 363–368. [https://doi.org/10.1016/S0956-7135\(98\)00127-3](https://doi.org/10.1016/S0956-7135(98)00127-3)
- Griffiths, M.W., (2000). Milk and unfermented milk products, in: *Microbiological Safety and Quality of Food*. pp. 507–534.
- Gusnaniar, N., Sjollem, J., Jong, E.D., Woudstra, W., de Vries, J., Nuryastuti, T., van der Mei, H.C., Busscher, H.J., (2017). Influence of biofilm lubricity on shear-induced transmission of staphylococcal biofilms from stainless steel to silicone rubber. *Microb. Biotechnol.* 10, 1744–1752. <https://doi.org/10.1111/1751-7915.12798>
- Haas, C.N., Rose, J.B., Gerba, C.P., (2014). *Quantitative Microbial Risk Assessment*. John Wiley & Sons, Inc, Hoboken, New Jersey. <https://doi.org/10.1002/9781118910030>
- Hammer, T.R., Mucha, H., Hoefler, D., (2011). Infection risk by dermatophytes during storage and after domestic laundry and their temperature-dependent inactivation. *Mycopathologia* 171, 43–49. <https://doi.org/10.1007/s11046-010-9347-9>
- Hassan, Z.U., Al Thani, R., Balmas, V., Migheli, Q., Jaoua, S., (2019). Prevalence of *Fusarium* fungi and their toxins in marketed feed. *Food Control* 104, 224–230. <https://doi.org/10.1016/j.foodcont.2019.04.045>
- Hauthal, H.G., Wagner, G. (Eds.), (2003). *Reinigungs- und Pflegemittel im Haushalt: Chemie, Anwendung, Ökologie und Verbrauchersicherheit*, 2nd ed. Verlag für chemische Industrie

- H. Ziolowsky GmbH, Augsburg.
- Heller, K., (2006). Mikrobiologie der Dauermilcherzeugnisse, in: Weber, H. (Ed.), *Milch Und Milchprodukte*. Behr, Hamburg, pp. 419–442.
- Ho, T.K., (1998). The random subspace method for constructing decision forests. *IEEE Trans. Pattern Anal. Mach. Intell.* 20, 832–844. <https://doi.org/10.1109/34.709601>
- Honisch, M., Brands, B., Stamminger, R., Bockmühl, D.P., (2015). Impact of the organic soil matrix on the antimicrobial effect of laundering 32, 2015.
- Honisch, M., Brands, B., Weide, M., Speckmann, H.D., Stamminger, R., Bockmühl, D.P., (2016). Antimicrobial efficacy of laundry detergents with regard to time and temperature in domestic washing machines. *Tenside, Surfactants, Deterg.* 53, 547–552. <https://doi.org/10.3139/113.110465>
- Honisch, M., Stamminger, R., Bockmühl, D.P., (2014a). Impact of wash cycle time, temperature and detergent formulation on the hygiene effectiveness of domestic laundering. *J. Appl. Microbiol.* 117, 1787–1797. <https://doi.org/10.1111/jam.12647>
- Honisch, M., Stamminger, R., Bockmühl, D.P., (2014b). Impact of wash cycle time, temperature and detergent formulation on the hygiene effectiveness of domestic laundering. *J. Appl. Microbiol.* 117, 1787–1797. <https://doi.org/10.1111/jam.12647>
- Hook, I., Schmitz, A., Stamminger, R., (2017). Dishwashing behaviour of European consumers with regard to the acceptance of long programme cycles. *Energy Effic.* 1–14. <https://doi.org/10.1007/s12053-017-9539-y>
- Houghton, J., (1850). Table Furniture Cleaning machine. United States Pat. Off. U.S. Pat. 7365.
- Huang, D., Cui, L.Q., Sajid, A., Zainab, F., Wu, Q., Wang, X., Yuan, Z., (2019). The epigenetic mechanisms in *Fusarium* mycotoxins induced toxicities. *Food Chem. Toxicol.* 123, 595–601. <https://doi.org/10.1016/j.fct.2018.10.059>
- Hubbuch, M.A.M.A., Goodall, K.G.K.G., (1999). Amount and composition of soils in German dish washers: Comparison to standard test conditions. *SÖFW-journal* 125, 14–20.
- Huss, H.H., (1997). Control of indigenous pathogenic bacteria in seafood. *Food Control* 8, 91–98.
- Huttenlochner, K., Müller-Renno, C., Ziegler, C., Merz, R., Merz, B., Kopnarski, M., Chodorski, J., Schlegel, C., Ulber, R., (2017). Removing biofilms from stainless steel without changing surface properties relevant for bacterial attachment. *Biointerphases* 12,



- 02C404. <https://doi.org/10.1116/1.4982196>
- IEC 53A WG3, (2019). Basic investigations on the antimicrobial efficacy of domestic automatic dishwashing processes.
- Ihne, S., (2006). Investigation of chemical and microbiological residues on dishes cleaned by hand and machine on the basis of specific examples. Shaker Verlag, Aachen.
- International Commission on Microbiological Specifications for Foods (ICMSF), (2019a). Milk and dairy products, in: *Microorganisms in Foods*. pp. 643–715.
- International Commission on Microbiological Specifications for Foods (ICMSF), (2019b). Fish and fish products, in: *Microorganisms in Foods*. pp. 174–249. [https://doi.org/10.1007/978-1-4615-6095-1\\_3](https://doi.org/10.1007/978-1-4615-6095-1_3)
- International Commission on Microbiological Specifications for Foods (ICMSF), (2019c). Meat and meat products, in: *Microorganisms in Foods*. pp. 1–106.
- International Commission on Microbiological Specifications for Foods (ICMSF), (2019d). Poultry Products, in: *Microorganisms in Foods*. pp. 107–173. <https://doi.org/10.3923/pjbs.2003.883.886>
- International Electrotechnical Commission, (2015). IEC 60436:2015 Electric dishwashers for household use - Methods for measuring the performance, 4.0. ed. VDE-Verlag.
- Jay, J.M., Loessner, M.J., Golden, D.M., (2005). *Modern Food Microbiology*, Food Science Text Series. Springer US, Boston, MA. <https://doi.org/10.1007/b100840>
- Ji, Y.W., Cho, Y.J., Lee, C.H., Hong, S.H., Chung, D.Y., Kim, E.K., Lee, H.K., (2015). Comparison of surface roughness and bacterial adhesion between cosmetic contact lenses and conventional contact lenses. *Eye Contact Lens* 41, 25–33. <https://doi.org/10.1097/ICL.0000000000000054>
- Jiang, R., Zhang, X., Zhang, M.Q., (2013). *Basics of Bioinformatics*. Springer Berlin Heidelberg, Berlin, Heidelberg. <https://doi.org/10.1007/978-3-642-38951-1>
- Johansson, E., Ståhl Wernersson, E., Hakanson, H., (2004). Effects on the Survival of *Enterococcus Faecium* in Dishwater. *Foodserv. Res. Int.* 15, 118–128. <https://doi.org/10.1111/j.1745-4506.2005.00002.x>
- Katsikogianni, M., Missirlis, Y.F., Harris, L., Douglas, J., (2004). Concise review of mechanisms of bacterial adhesion to biomaterials and of techniques used in estimating bacteria-material interactions. *Eur. Cells Mater.* 8, 37–57.

<https://doi.org/10.22203/eCM.v008a05>

- Kerschgens, S., Artelt, J., Brychcy, K.A., Von Esmarch-Rummler, B., Stamminger, R., (2016). Hygienic performance of commercial dishwashers with water-change system - An experimental study. *Tenside, Surfactants, Deterg.* 53, 553–560. <https://doi.org/10.3139/113.110459>
- Klapper, D., Zinn, M.-K., Schulze-Struchtrup, S., von Esmarch-Rummler, B., Stamminger, R., (2018). *Micrococcus luteus* – An Alternative Test Germ for Testing the Hygienic Performance of Commercial Freshwater Dishwashers. *Tenside Surfactants Deterg.* 55, 369–375. <https://doi.org/10.3139/113.110578>
- Klein, G., Bartelt, E., (2008). Mikrobiologie der Muscheln, in: Weber, H. (Ed.), *Fleisch - Fisch - Feinkost*. Behr, Hamburg, pp. 719–730.
- Kleinfeld, H.J., Buchbinder, L., (1947). Dishwashing Practice and Effectiveness (Swab-rinse Test) in a Large City as Revealed by a Survey of 1,000 Restaurants. *Am. J. Public Heal. Nations Heal.* 37, 379–389. <https://doi.org/10.2105/AJPH.37.4.379>
- Klingelhöfer, D., Braun, M., Schöffel, N., Oremek, G.M., Brüggmann, D., Groneberg, D.A., (2020). Ochratoxin – Characteristics, influences and challenges of global research. *Food Control* 114, 107230. <https://doi.org/10.1016/j.foodcont.2020.107230>
- Kruskal, W.H., Wallis, W.A., (1952). *Use of Ranks in One-Criterion Variance Analysis* Author ( s ): William H . Kruskal and W . Allen Wallis Published by : Taylor & Francis , Ltd . on behalf of the American Statistical Association Stable URL : <http://www.jstor.org/stable/2280779> Accessed : 02 47, 583–621.
- Kusumaningrum, H.D., Van Putten, M.M., Rombouts, F.M., Beumer, R.R., (2002). Effects of antibacterial dishwashing liquid on foodborne pathogens and competitive microorganisms in kitchen sponges. *J. Food Prot.* 65, 61–65. <https://doi.org/10.4315/0362-028X-65.1.61>
- Lack, W.K., Becker, B., Holzapfel, W.H., (1995). Hygienischer Status frischer vorverpackter Mischsalate im Jahr 1995. *Arch. für Leb. = J. food Saf. food Qual.* 47, 129–152.
- Laport, M.S., da Silva, M.R., Silva, C.C., do Carmo de Freire Bastos, M., Giambiagi-deMarval, M., (2003). Heat-Resistance and Heat-Shock Response in the Nosocomial Pathogen *Enterococcus faecium*. *Curr. Microbiol.* 46, 313–317. <https://doi.org/10.1007/s00284-002-3828-0>
- Lee, J., Cartwright, R., Grueser, T., Pascall, M.A., (2007). Efficiency of manual dishwashing

- conditions on bacterial survival on eating utensils. *J. Food Eng.* 80, 885–891. <https://doi.org/10.1016/j.jfoodeng.2006.08.003>
- Leung, Y.L., (2014). *Staphylococcus aureus*, *Encyclopedia of Toxicology: Third Edition*. <https://doi.org/10.1016/B978-0-12-386454-3.00539-X>
- Light-Industry Standard of the People's Republic of China, (2013). QB/T 1520-2013 Household and similar electrical dishwasher.
- Lindblad, M., Lindmark, H., Lambertz, S.T., Lindqvist, R., (2006). Microbiological baseline study of broiler chickens at Swedish slaughterhouses. *J. Food Prot.* 69, 2875–2882. <https://doi.org/10.4315/0362-028X-69.12.2875>
- Lindblad, M., Lindmark, H., Thisted Lambertz, S., Lindqvist, R., (2007). Microbiological baseline study of swine carcasses at Swedish slaughterhouses. *J. Food Prot.* 70, 1790–1797. <https://doi.org/10.4315/0362-028X-70.8.1790>
- Luber, P., Bartelt, E., (2007). Enumeration of *Campylobacter* spp. on the surface and within chicken breast fillets. *J. Appl. Microbiol.* 102, 313–318. <https://doi.org/10.1111/j.1365-2672.2006.03105.x>
- Luber, P., Brynestad, S., Topsch, D., Scherer, K., Bartelt, E., (2006). Quantification of *Campylobacter* Species Cross-Contamination during Handling of Contaminated Fresh Chicken Parts in Kitchens. *Appl. Environ. Microbiol.* 72, 66–70. <https://doi.org/10.1128/AEM.72.1.66-70.2006>
- Madigan, M.T., Martinko, J.M., Stahl, D.A., Clark, D.P., (2013). *Brock Mikrobiologie*, 13., aktua. ed, Pearson - Biologie. Pearson, München u.a.
- Martinez, S., Lopez, M., Bernardo, A., (2003). Thermal inactivation of *Enterococcus faecium*: effect of growth temperature and physiological state of microbial cells. *Lett. Appl. Microbiol.* 37, 475–481. <https://doi.org/10.1046/j.1472-765X.2003.01431.x>
- Mattick, K., Durham, K., Domingue, G., Jørgensen, F., Sen, M., Schaffner, D.W., Humphrey, T., (2003a). The survival of foodborne pathogens during domestic washing-up and subsequent transfer onto washing-up sponges, kitchen surfaces and food. *Int. J. Food Microbiol.* 85, 213–226. [https://doi.org/10.1016/S0168-1605\(02\)00510-X](https://doi.org/10.1016/S0168-1605(02)00510-X)
- Mattick, K., Durham, K., Hendrix, M., Slader, J., Griffith, C., Sen, M., Humphrey, T., (2003b). The microbiological quality of washing-up water and the environment in domestic and commercial kitchens. *J. Appl. Microbiol.* 94, 842–848. <https://doi.org/10.1046/j.1365->

2672.2003.01904.x

- McNeil, E., Choper, E.A., Banville, R.R., (1965). Microbiology of Home Type Mechanical Dishwashing. *Soap Chem. Spec.* 41, 125–137.
- Miele Limited, (2009). Miele dishwasher milestones [WWW Document]. URL [https://ca.miele.ca/Media/docs/press/011-045-GT\\_Dish-Milestones.en-CA.pdf](https://ca.miele.ca/Media/docs/press/011-045-GT_Dish-Milestones.en-CA.pdf) (accessed 1.6.20).
- Milne, N.J., (1998). Oxygen bleaching systems in domestic laundry. *J. Surfactants Deterg.* 1, 253–261. <https://doi.org/10.1007/s11743-998-0029-z>
- Mohamad, A.J., Zhu, X., Liu, X., Pfleging, W., Torge, M., (2013). Effect of surface topography on hydrophobicity and bacterial adhesion of polystyrene. 2013 Int. Conf. Manip. Manuf. Meas. Nanoscale, 3M-NANO 2013 - Conf. Proc. 228–233. <https://doi.org/10.1109/3M-NANO.2013.6737421>
- Müller-Kirschbaum, T., Kessler, A., Scheidgen, A., (2020). 60 Jahre Sinnerscher Kreis: ein Blick in die Zukunft des Waschens. *Sofw J.*
- Novozymes, (2010). A guide to Novozymes household care 77.
- NSF/ANSI 184-2019 - Residential Dishwashers, (2019).
- Nychas, G.-J.E., Marshall, D.L., Sofos, J.N., (2007). Meat, Poultry, and Seafood, in: *Food Microbiology: Fundamentals and Frontiers*, Third Edition. American Society of Microbiology, pp. 105–140. <https://doi.org/10.1128/9781555815912.ch6>
- Ossowski, B., Duchmann, U., (1997). Der Einfluss des haushaltsüblichen Waschprozesses auf mykotisch kontaminierte Textilien. *Hautarzt* 48, 397–401. <https://doi.org/10.1007/s001050050600>
- Ossowski, B., Duchmann, U., Boslet, W., (1999). Desinfizierende Behandlung von Textilien zur Rezidivprophylaxe bei vulvovaginalen Candidosen. *Geburtshilfe Frauenheilkd.* 59, 175–179. <https://doi.org/10.1055/s-1999-14184>
- Otte-Südi, I., (2006a). Mikrobiologie der Rohmilch, in: Weber, H. (Ed.), *Milch Und Milchprodukte*. Behr's Verlag, Hamburg, pp. 1–38.
- Otte-Südi, I., (2006b). Mikrobiologie der pasteurisierten Trinkmilch, in: Weber, H. (Ed.), *Milch Und Milchprodukte*. Behr's Verlag, Hamburg, pp. 39–71.
- Patkavak, M., (2016). An experimental study of effective factors on soil removal efficiency in

- cleaning processes by solid stream jet nozzles. *J. Therm. Eng.* 2, 774–779.
- Peart, V., Johnston, K., (1976). Soil Removal in Automatic Dishwashing. *Home Econ. Res. J.* 5, 114–122.
- Pérez-Mohedano, R., Letzelter, N., Bakalis, S., (2017). Integrated model for the prediction of cleaning profiles inside an automatic dishwasher. *J. Food Eng.* 196, 101–112. <https://doi.org/10.1016/j.jfoodeng.2016.09.031>
- Raghupathi, P.K., Zupančič, J., Brejnrod, A.D., Jacquiod, S., Houf, K., Burmølle, M., Gunde-Cimerman, N., Sørensen, S.J., (2018). Microbial Diversity and Putative Opportunistic Pathogens in Dishwasher Biofilm Communities - supplementary material. *Appl. Environ. Microbiol.* 84. <https://doi.org/10.1128/AEM.02755-17>
- Renner, P., Peters, J., (1999). Resistance of enterococci to heat and chemical agents. *Zentralblatt für Hyg. und Umweltmedizin* 202, 41–50. [https://doi.org/10.1016/S0934-8859\(99\)80052-2](https://doi.org/10.1016/S0934-8859(99)80052-2)
- Reuter, G., (2008). Mikrobiologie des Fleisches, in: Weber, H. (Ed.), *Fleisch - Fisch - Feinkost*. Behr, Hamburg, pp. 1–111.
- Rice, E.W., Clark, R.M., Johnson, C.H., (1999). Chlorine inactivation of *Escherichia coli* O157:H7. *Emerg. Infect. Dis.* 5, 461–3. <https://doi.org/10.3201/eid0503.990322>
- Richter, C.P., (2010). Automatic dishwashers: efficient machines or less efficient consumer habits? *Int. J. Consum. Stud.* 34, 228–234. <https://doi.org/10.1111/j.1470-6431.2009.00839.x>
- Richter, C.P., (2011). Usage of dishwashers: observation of consumer habits in the domestic environment. *Int. J. Consum. Stud.* 35, 180–186. <https://doi.org/10.1111/j.1470-6431.2010.00973.x>
- Riemelt, I., Bartel, B., (2003). *Milchwirtschaftliche Mikrobiologie*, 2. Auflage. ed. Behr, Hamburg.
- Robert-Koch-Institut, (2020). Aktuelle Statistik meldepflichtiger Infektionskrankheiten, Deutschland. *Epidemiol. Bull.* 2019, 1–3.
- Roberts, D., (1982). Factors contributing to outbreaks of food poisoning in England and Wales 1970–1979. *J. Hyg. (Lond).* 89, 491–498. <https://doi.org/10.1017/S0022172400071059>
- Roberts, D., (1990). Sources of infection: food. *Lancet.* [https://doi.org/10.1016/0140-6736\(90\)92352-I](https://doi.org/10.1016/0140-6736(90)92352-I)

- Rosenberg, U., (2003). Thermal Disinfection - The A0 Concept and the biological Background. *Zentralsterilisation* 11, 115–120.
- Rutala, W.A., Weber, D.J., (2004). Disinfection and Sterilization in Health Care Facilities: What Clinicians Need to Know. *Clin. Infect. Dis.* 39, 702–709. <https://doi.org/10.1086/423182>
- Sajitz, M., Grohmann, J., (2011). Hygiene Effects of Bleach Systems in Laundry Detergents. *SOFW J.* 137, 16–24. <https://doi.org/not available>
- Samelis, J., Björkroth, J., Kakouri, A., Rementzis, J., (2006). *Leuconostoc carnosum* associated with spoilage of refrigerated whole cooked hams in Greece. *J. Food Prot.* 69, 2268–2273. <https://doi.org/10.4315/0362-028X-69.9.2268>
- Samelis, J., de W. Blackburn, C., (2006). 9 – Managing microbial spoilage in the meat industry, in: *Food Spoilage Microorganisms*. p. 737.
- Satomi, M., Vogel, B.F., Gram, L., Venkateswaran, K., (2006). *Shewanella hafniensis* sp. nov. and *Shewanella morhuae* sp. nov., isolated from marine fish of the Baltic Sea. *Int. J. Syst. Evol. Microbiol.* 56, 243–249. <https://doi.org/10.1099/ijs.0.63931-0>
- Satomi, M., Vogel, B.F., Venkateswaran, K., Gram, L., (2007). Description of *Shewanella glacialipiscicola* sp. nov. and *Shewanella algidipiscicola* sp. nov., isolated from marine fish of the Danish Baltic Sea, and proposal that *Shewanella affinis* is a later heterotypic synonym of *Shewanella colwelliana*. *Int. J. Syst. Evol. Microbiol.* 57, 347–352. <https://doi.org/10.1099/ijs.0.64708-0>
- Scherer, K., Bartelt, E., Sommerfeld, C., Hildebrandt, G., (2006). Quantification of *Campylobacter* on the surface and in the muscle of chicken legs at retail. *J. Food Prot.* 69, 757–761. <https://doi.org/10.4315/0362-028X-69.4.757>
- Schulze Struchtrup, S., Stamminger, R., Amberg, C., Bockmühl, D., Brands, B., (2020). A Concept for Rapid Prediction of Microbiological Reduction in Automatic Dish Cleaning Processes: The Microbiological Inactivation Equivalent (MIE) Unit. *Tenside Surfactants Deterg.* 57, 489–505. <https://doi.org/10.3139/113.110699>
- Scott, E., Bloomfield, S.F., Barlow, C.G., (1982). An investigation of microbial contamination in the home. *J. Hyg. (Lond).* 89, 279–293. <https://doi.org/10.1017/S0022172400070819>
- Scullion, R., Harrington, C.S., Madden, R.H., (2006). Prevalence of *Arcobacter* spp. in raw milk and retail raw meats in Northern Ireland. *J. Food Prot.* 69, 1986–1990.

<https://doi.org/10.4315/0362-028X-69.8.1986>

Setlow, B., Setlow, P., (1998). Heat killing of *Bacillus subtilis* spores in water is not due to oxidative damage. *Appl. Environ. Microbiol.* 64, 4109–4112.  
<https://doi.org/10.1128/aem.64.10.4109-4112.1998>

Šidák, Z., (1967). Rectangular Confidence Regions for the Means of Multivariate Normal Distributions. *J. Am. Stat. Assoc.* 62, 626–633.  
<https://doi.org/10.1080/01621459.1967.10482935>

Sinner, H., (1960). Über das Waschen mit Haushaltwaschmaschinen - In welchem Umfange erleichtern Haushaltwaschmaschinen und -geräte das Wäschehaben im Haushalt?, 2nd ed. Haus + Heim-Verlag, Hamburg.

Smelt, J.P.P.M., Brul, S., (2014). Thermal Inactivation of Microorganisms. *Crit. Rev. Food Sci. Nutr.* 54, 1371–1385. <https://doi.org/10.1080/10408398.2011.637645>

Ståhl Wernersson, E., Jeppsson, M., Hakanson, H., (2006). The effect of dishwasher parameters on the survival of *Staphylococcus aureus* and vegetative cells and spores of *Bacillus cereus*. *J. Foodserv.* 17, 111–118. <https://doi.org/10.1111/j.1745-4506.2006.00026.x>

Ståhl Wernersson, E., Johansson, E., Hakanson, H., (2004a). Granule-assisted dishwashing improves cleanliness. *Food Serv. Technol.* 4, 129–137. <https://doi.org/10.1111/j.1471-5740.2004.00099.x>

Ståhl Wernersson, E., Johansson, E., Hakanson, H., (2005). Dishwashing Water Quality Properties, in: *Water Encyclopedia, Major Reference Works*. John Wiley & Sons, Inc., Hoboken, NJ, USA. <https://doi.org/10.1002/047147844X.wq301>

Ståhl Wernersson, E., Johansson, E., Håkanson, H., (2004b). Cross-contamination in dishwashers. *J. Hosp. Infect.* 56, 312–317. <https://doi.org/10.1016/j.jhin.2004.01.002>

Stamminger, R., Badura, R., Broil, G., Dörr, S., Elschenbroich, A., (2003). A European Comparison of Cleaning Dishes by hand, in: *Proceedings of the International Conference on Energy Efficiency in Domestic Appliances and Lighting (EEDAL)*. Turin, Italy, pp. 735–743.

Stamminger, R., Elschenbroich, A., Rummeler, B., Broil, G., (2007). Washing-up behaviour and techniques in Europe. *Hauswirtschaft und Wiss.* 31–40.

Stamminger, R., Schmitz, A., Hook, I., (2018). Why consumers in Europe do not use energy efficient automatic dishwashers to clean their dishes? *Energy Effic.* 1–17.

<https://doi.org/10.1007/s12053-018-9648-2>

Statistisches Bundesamt, (2019). [www.destatis.de](http://www.destatis.de) Ausstattung privater Haushalte mit elektrischen Haushalts- und sonstigen Geräten - Deutschland - Statistisches Bundesamt (Destatis) [WWW Document]. URL [https://www.destatis.de/DE/ZahlenFakten/GesellschaftStaat/EinkommenKonsumLebensbedingungen/AusstattungGebrauchsguetern/Tabellen/Haushaltsgeraete\\_D.html](https://www.destatis.de/DE/ZahlenFakten/GesellschaftStaat/EinkommenKonsumLebensbedingungen/AusstattungGebrauchsguetern/Tabellen/Haushaltsgeraete_D.html) (accessed 1.28.19).

Steiner, U., Wieser, M., Vybiral, D., Patel, B.K.C., Lubitz, W., Denner, E.B.M., Kämpfer, P., Maszenan, A.M., Seviour, R.J., Schumann, P., Radax, C., Tindall, B., Busse, H.-J., (2002). Emended descriptions of the genus *Micrococcus*, *Micrococcus luteus* (Cohn 1872) and *Micrococcus lylae* (Kloos et al. 1974). *Int. J. Syst. Evol. Microbiol.* 52, 629–637. <https://doi.org/10.1099/00207713-52-2-629>

Teuber, M., (1987). *Grundriss der praktischen Mikrobiologie für das Molkereifach*. Mann, 1987. 2., erw. Aufl., Gelsenkirchen-Buer.

Tierische Lebensmittel-Hygieneverordnung, (2018). , Bundesgesetzblatt.

Traoré, O., Springthorpe, V.S., Sattar, S.A., (2002). A quantitative study of the survival of two species of *Candida* on porous and non-porous environmental surfaces and hands. *J. Appl. Microbiol.* 92, 549–555. <https://doi.org/10.1046/j.1365-2672.2002.01560.x>

Truong, V.K., Lapovok, R., Estrin, Y.S., Rundell, S., Wang, J.Y., Fluke, C.J., Crawford, R.J., Ivanova, E.P., (2010). The influence of nano-scale surface roughness on bacterial adhesion to ultrafine-grained titanium. *Biomaterials* 31, 3674–3683. <https://doi.org/10.1016/j.biomaterials.2010.01.071>

Tukey, J.W., (1949). Comparing Individual Means in the Analysis of Variance. *Biometrics* 5, 99–114. <https://doi.org/10.2307/3001913>

Verordnung (EG) Nr. 178/2002 Des Europäischen Parlaments und des Rates vom 28. Januar 2002 zur Festlegung der allgemeinen Grundsätze und Anforderungen des Lebensmittelrechts, zur Errichtung der Europäischen Behörde für Lebensmittelsicherheit und zur Festl, (2002).

VERORDNUNG (EG) Nr. 2073/2005 DER KOMMISSION über mikrobiologische Kriterien für Lebensmittel, (2013). 32, 1–27.

Vihavainen, E., Lundström, H.S., Susiluoto, T., Koort, J., Paulin, L., Auvinen, P., Björkroth,



- K.J., (2007). Role of broiler carcasses and processing plant air in contamination of modified-atmosphere-packaged broiler products with psychrotrophic lactic acid bacteria. *Appl. Environ. Microbiol.* 73, 1136–1145. <https://doi.org/10.1128/AEM.01644-06>
- Vogel, B.F., Venkateswaran, K., Satomi, M., Gram, L., (2005). Identification of *Shewanella baltica* as the Most Important H<sub>2</sub>S-Producing Species during Iced Storage of Danish Marine Fish. *Appl. Environ. Microbiol.* 71, 6689–6697. <https://doi.org/10.1128/AEM.71.11.6689-6697.2005>
- Ward, W.E., Dack, G.M., (1939). Bacteriological Tests on Mechanical Dishwashers for Home Use. *Am. J. Public Heal. Nations Heal.* 29, 1114–1118. <https://doi.org/10.2105/AJPH.29.10.1114>
- Weber, H. (Ed.), (2008a). *Mikrobiologie der Krebstiere Crustacea*, in: *Fleisch - Fisch- Feinkost*. Behr, Hamburg, pp. 739–758.
- Weber, H., (2008b). *Mikrobiologie der Rohwurst*, in: Weber, H. (Ed.), *Fleisch - Fisch- Feinkost*. Behr, Hamburg, pp. 317–343.
- Wegner, K., Weber, H., (2006). *Mikrobiologie der Sauermilcherzeugnisse*, in: Weber, H. (Ed.), *Milch Und Milchprodukte*. Behr, Hamburg, pp. 195–278.
- Weise, E., (2008). *Mikrobiologie des Geflügels*, in: Weber, H. (Ed.), *Fleisch - Fisch - Feinkost*. Behr, Hamburg, pp. 563–646.
- WHO | Food hygiene [WWW Document], (2020). URL [https://www.who.int/foodsafety/areas\\_work/food-hygiene/en/](https://www.who.int/foodsafety/areas_work/food-hygiene/en/) (accessed 4.8.20).
- Wiener, A.L. and M., (2003). Classification and Regression by randomForest. *R News* 2 3, 18–22.
- Zalar, P., Novak, M., Hoog, G.S.D.E., Gunde-cimerman, N., (2011). Dishwashers - A man-made ecological niche accommodating human opportunistic fungal pathogens. *Fungal Biol.* 1–11. <https://doi.org/10.1016/j.funbio.2011.04.007>
- Zhang, P., Kong, L., Setlow, P., Li, Y.Q., (2010). Characterization of wet-heat inactivation of single spores of *Bacillus* species by dual-trap raman spectroscopy and elastic light scattering. *Appl. Environ. Microbiol.* 76, 1796–1805. <https://doi.org/10.1128/AEM.02851-09>
- Zickrick, K., Weber, H., (2006). *Mikrobiologie der Käse*, in: Weber, H. (Ed.), *Milch Und Milchprodukte*. Behr, Hamburg, pp. 313–418.

- Zinn, M.-K., Klapper, D., Von Esmarch-Rummler, B., Bockmühl, D., (2018). Development of a test method for analyzing the hygienic performance of commercial dishwashers operating on the fresh water principle. *Tenside, Surfactants, Deterg.* 55, 376–382. <https://doi.org/10.3139/113.110579>
- Zupančič, J., Novak Babič, M., Zalar, P., Gunde-Cimerman, N., (2016). The Black Yeast *Exophiala dermatitidis* and Other Selected Opportunistic Human Fungal Pathogens Spread from Dishwashers to Kitchens. *PLoS One* 11, e0148166. <https://doi.org/10.1371/journal.pone.0148166>
- Zupančič, J., Raghupathi, P.K., Houf, K., Burmølle, M., Sørensen, S.J., Gunde-Cimerman, N., (2018). Synergistic interactions in microbial biofilms facilitate the establishment of opportunistic pathogenic fungi in household dishwashers. *Front. Microbiol.* 9, 0–13. <https://doi.org/10.3389/fmicb.2018.00021>
- Zupančič, J., Turk, M., Črnigoj, M., Ambrožič Avguštin, J., Gunde-Cimerman, N., (2019). The dishwasher rubber seal acts as a reservoir of bacteria in the home environment. *BMC Microbiol.* 19, 1–15. <https://doi.org/10.1186/s12866-019-1674-5>



## Appendix: List of figures

Figure 1: Schematic overview of the automated dishwashing process.....	7
Figure 2: The bleaching mechanism in detergents with activated oxygen bleach (modified after Hauthal and Wagner, 2003; Milne, 1998; Sajitz and Grohmann, 2011).....	14
Figure 3: Biomonitor as used in the dishwasher tests. The biomonitor is made of austenitic steel and has unilateral longitudinal grain with granulation 80 on the front side. (own representation) .....	37
Figure 4: Biomonitor used for tests in the tergotometer and in hand dishwashing tests. (own representation) .....	37
Figure 5: Typical temperature profile of a dishwashing cycle with a main cleaning cycle temperature of 65 °C and a final rinsing temperature of 50 °C is shown. The different phases are water inlet (a), heating phase (b), main cleaning cycle (c), water intake for first rinsing (d), first rinsing cycle (e), water intake for final rinsing (f), heating phase for final rinse (g), final rinsing cycle (h) and drying period (i). .....	41
Figure 6: Biomonitor fastened to the holder that is mounted to a dinner plate. The contaminated side of the biomonitor is facing away from the plate (own representation). .....	42
Figure 7: Localisation of the biomonitor in the lower basket of the dishwasher. On each side, three biomonitor with one bacterial strain are added (own representation). .....	42
Figure 8: Recovery of the microorganisms during the extraction of the biomonitor contaminated with <i>M. luteus</i> DSM 1790 compared to the bacterial load of the inoculation solution. For each set of extraction parameters, the mean with standard deviation of three independent repeats is shown for biomonitor oriented with the contaminated side towards the glass beads (front) or away from the glass beads (back). .....	52
Figure 9: Recovery of the microorganisms during the extraction of the biomonitor contaminated with <i>Ps. aeruginosa</i> DSM 939 compared to the bacterial load of the inoculation solution. For each set of extraction parameters, the mean with standard deviation of three independent repeats is shown for biomonitor oriented with the contaminated side towards the glass beads (front) or away from the glass beads (back). .....	53
Figure 10: Microbial counts on biomonitor contaminated with <i>M. luteus</i> DSM 1790 in BAMS after hand dishwashing using different test parameters and the respective initial microbial counts. The asterisks represent statistically significant lower microbial counts compared to the initial counts. ....	55
Figure 11: Differences in the LR caused by the change of the water temperature from 40 °C to 50 °C in hand dishwashing tests with different test parameters. The	

asterisks represent statistically significant microbial counts between the two observed temperatures. ....	56
Figure 12: Microbial load on stainless steel biomonitors contaminated with <i>M. luteus</i> DSM 1790 after hand dishwashing with different intensities of mechanical action applied to the surfaces. Significant differences are indicated by asterisks. ....	58
Figure 13: Standardized logarithmic reductions (SLR) on biomonitors contaminated with <i>Ent. faecium</i> DSM 2146 in BAMS and tested under the given parameters in the tergotometer. The dotted line indicates the maximum SLR. Means with standard deviations from 3 biomonitors are shown. ....	61
Figure 14: Overview of the microbial counts of <i>Ent. faecium</i> DSM 2146 at the end of the test in the tergotometer. Recovered count from the biomonitors in the EL are given together with the count in the water. The red parts indicate the number of inactivated bacteria compared to the initial counts. The different heights of the bars are due to different initial counts. ....	63
Figure 15: Standardized logarithmic reductions (SLR) on biomonitors contaminated with <i>M. luteus</i> DSM 1790 in BAMS and tested under the given parameters in the tergotometer. The dotted line indicates the maximum SLR. Means with standard deviations from 3 biomonitors are shown. ....	64
Figure 16: Overview of the microbial counts of <i>M. luteus</i> DSM 1790 at the end of the test in the tergotometer. Recovered count from the biomonitors in the EL are given together with the count in the water. The red parts indicate the number of inactivated bacteria compared to the initial counts. ....	66
Figure 17: Standardized logarithmic reductions (SLR) on biomonitors contaminated with <i>S. aureus</i> in BAMS and tested under the given parameters in the tergotometer. The dotted line indicates the maximum SLR. Means with standard deviations from 3 biomonitors are shown. ....	67
Figure 18: Overview of the microbial counts of <i>S. aureus</i> at the end of the test in the tergotometer. Recovered count from the biomonitors in the EL are given together with the count in the water. The red parts indicate the number of inactivated bacteria compared to the initial counts. The different heights of the bars are due to different initial counts. ....	69
Figure 19: Overview of the standardized logarithmic reductions of <i>Ent. faecium</i> DSM 2146 on biomonitors. The dotted lines indicate the maximum SLR. Statistically significant differences in SLRs between different temperatures are marked with asterisks. ....	70
Figure 20: Overview of the standardized logarithmic reductions (SLR) of <i>Ent. faecium</i> DSM 2146 in the water. The dotted lines indicate the maximum SLR. No standard deviations or significances are given due to the small sample size. ....	71

Figure 21: Overview of the standardized logarithmic reductions of <i>M. luteus</i> DSM 1790 on biomonitors. The dotted lines indicate the maximum SLR. Statistically significant differences in SLRs between different temperatures are marked with asterisks.....	72
Figure 22: Overview of the standardized logarithmic reductions of <i>M. luteus</i> DSM 1790 in the water. The dotted lines indicate the maximum SLR. No standard deviations or significances are given due to the small sample size. ....	73
Figure 23: Overview of the standardized logarithmic reductions of <i>S. aureus</i> DSM 939 on biomonitors. The dotted lines indicate the maximum SLR. Statistically significant differences in SLRs between different temperatures are marked with asterisks.....	75
Figure 24: Overview of the standardized logarithmic reductions of <i>S. aureus</i> DSM 939 in the water. The dotted lines indicate the maximum SLR. No standard deviations or significances are given due to the small sample size.....	76
Figure 25: SLR on biomonitors inoculated with <i>Ent. faecium</i> DSM 2146 after tests in the tergotometer with the given parameters. Statistically significant differences caused by a change in the detergent are marked with asterisks.....	77
Figure 26: Overview of the standardized logarithmic reductions (SLR) of <i>Ent. faecium</i> DSM 2146 in the water. The dotted lines indicate the maximum SLR. No standard deviations or significances are given due to the small sample size.....	78
Figure 27: SLR on biomonitors inoculated with biomonitors inoculated with <i>M. luteus</i> DSM 1790 after tests in the tergotometer with the given parameters. Statistically significant differences caused by a change in the detergent are marked with asterisks.....	79
Figure 28: Overview of the standardized logarithmic reductions (SLR) of <i>M. luteus</i> DSM 1790 in the water. The dotted lines indicate the maximum SLR. No standard deviations or significances are given due to the small sample size. ....	80
Figure 29: SLR on biomonitors inoculated with <i>S. aureus</i> DSM 939 after tests in the tergotometer with the given parameters. Statistically significant differences caused by a change in the detergent are marked with asterisks.....	81
Figure 30: Overview of the standardized logarithmic reductions (SLR) of <i>S. aureus</i> DSM 939 in the water. The dotted lines indicate the maximum SLR. No standard deviations or significances are given due to the small sample size. ....	82
Figure 31: Overview of SLR on biomonitors inoculated with <i>Ent. faecium</i> DSM 2146 after tests in the tergotometer with the given parameters. Statistically significant differences caused by a change in the duration are marked with asterisks.....	83
Figure 32: Overview of the SLR of <i>Ent. faecium</i> DSM 2146 in the water. The dotted lines indicate the maximum SLR. No standard deviations or significances are given due to the small sample size. ....	84

- Figure 33: Overview of SLR on biomonitors inoculated with *M. luteus* DSM 1790 after tests in the tergotometer with the given parameters. Statistically significant differences caused by a change in the duration are marked with asterisks..... 85
- Figure 34: Overview of the SLR of *M. luteus* DSM 1790 in the water. The dotted lines indicate the maximum SLR. No standard deviations or significances are given due to the small sample size. .... 86
- Figure 35: Overview of SLR on biomonitors inoculated with *S. aureus* DSM 939 after tests in the tergotometer with the given parameters. Statistically significant differences caused by a change in the duration are marked with asterisks..... 87
- Figure 36: Overview of the SLR of *S. aureus* DSM 939 in the water. The dotted lines indicate the maximum SLR. No standard deviations or significances are given due to the small sample size. .... 88
- Figure 37: Standardized logarithmic reductions on biomonitors contaminated with *Ent. faecium* DSM 2146 after cleaning cycles with the given test parameters in the automated dishwasher. The dotted line indicates the maximum SLR. Each data point represents mean values of 9 biomonitors cleaned in 3 independent test cycles. Dashed lines represent the initial load of the biomonitors..... 91
- Figure 38: Standardized logarithmic reductions on biomonitors contaminated with *M. luteus* DSM 1790 after cleaning cycles with the given test parameters in the automated dishwasher. The dotted line indicates the maximum SLR. Each data point represents mean values of 9 biomonitors cleaned in 3 independent test cycles. Dashed lines represent the initial load of the biomonitors..... 93
- Figure 39: Overview of the standardized logarithmic reductions (SLR) of *Ent. faecium* DSM 2146 on biomonitors used in tests with a duration of 5 min. Statistically significant differences caused by a change in the test temperature are marked with asterisks..... 94
- Figure 40: Overview of the standardized logarithmic reductions (SLR) of *Ent. faecium* DSM 2146 on biomonitors used in tests with a duration of 10 min. Statistically significant differences caused by a change in the test temperature are marked with asterisks..... 95
- Figure 41: Overview of the standardized logarithmic reductions (SLR) of *Ent. faecium* DSM 2146 on biomonitors used in tests with a duration of 15 min. Statistically significant differences caused by a change in the test temperature are marked with asterisks..... 96
- Figure 42: Overview of the standardized logarithmic reductions (SLR) of *Ent. faecium* DSM 2146 on biomonitors used in tests with a duration of 45 min. Statistically significant differences caused by a change in the test temperature are marked with asterisks..... 97

Figure 43: Overview of the standardized logarithmic reductions (SLR) of <i>Ent. faecium</i> DSM 2146 on biomonitors used in tests with a duration of 90 min. Statistically significant differences caused by a change in the test temperature are marked with asterisks.....	98
Figure 44: Overview of the standardized logarithmic reductions (SLR) of <i>M. luteus</i> DSM 1790 on biomonitors used in tests with a duration of 5 min. Statistically significant differences caused by a change in the test temperature are marked with asterisks.....	99
Figure 45: Overview of the standardized logarithmic reductions (SLR) of <i>M. luteus</i> DSM 1790 on biomonitors used in tests with a duration of 10 min. Statistically significant differences caused by a change in the test temperature are marked with asterisks.....	100
Figure 46: Overview of the standardized logarithmic reductions (SLR) of <i>M. luteus</i> DSM 1790 on biomonitors used in tests with a duration of 15 min. Statistically significant differences caused by a change in the test temperature are marked with asterisks.....	101
Figure 47: Overview of the standardized logarithmic reductions (SLR) of <i>M. luteus</i> DSM 1790 on biomonitors used in tests with a duration of 45 min. Statistically significant differences caused by a change in the test temperature are marked with asterisks.....	102
Figure 48: Overview of the standardized logarithmic reductions (SLR) of <i>M. luteus</i> DSM 1790 on biomonitors used in tests with a duration of 90 min. Statistically significant differences caused by a change in the test temperature are marked with asterisks.....	103
Figure 49: Standardized logarithmic reductions (SLR) of different <i>M. luteus</i> strains on stainless steel biomonitors in dishwasher runs with cleaning temperatures of 45 °C and 55 °C using different rinsing temperatures. Each data point represents means with standard deviations of 3 independent repeats with 3 biomonitors each. ....	104
Figure 50: Overview of the standardized logarithmic reduction (SLR) of <i>M. luteus</i> DSM 1790, <i>M. luteus</i> DSM 20030 <sup>T</sup> and <i>M. luteus</i> DSM 28269 on biomonitors caused by a change of the rinsing temperature in tests with the given cleaning temperatures. Statistically significant differences are marked with asterisks. Lines are for visualization only.....	106
Figure 51: Overview of the standardized logarithmic reductions (SLR) of <i>Ent. faecium</i> DSM 2146 on biomonitors. Statistically significant results caused by different detergent types are marked with asterisks.....	108
Figure 52: Overview of the standardized logarithmic reductions (SLR) of <i>M. luteus</i> DSM 1790 on biomonitors. Statistically significant differences caused by a change of the detergent are marked with asterisks. ....	109



Figure 53: Overview of the standardized logarithmic reductions (SLR) of <i>Ent. faecium</i> DSM 2146 on biomonitors. Statistically significant differences caused by a change of the cleaning duration are marked with asterisks. ....	111
Figure 54: Overview of the standardized logarithmic reductions (SLR) of <i>M. luteus</i> DSM 1790 on biomonitors. Statistically significant differences caused by a change of the cleaning duration are marked with asterisks. ....	112
Figure 55: Standardized logarithmic reduction (SLR) in the dishwasher depending on temperature and duration of the cleaning cycle. SLRs of cycles without detergent are shown. ....	135
Figure 56: Standardized logarithmic reduction (SLR) in the dishwasher depending on temperature and duration of the cleaning cycle. SLRs of cycles with bleach-free detergent are shown. ....	136
Figure 57: Standardized logarithmic reduction (SLR) in the dishwasher depending on temperature and duration of the cleaning cycle. SLRs of cycles with activated oxygen-bleach (AOB)-containing detergent are shown. ....	137
Figure 58: Standardized logarithmic reduction (SLR) in the dishwasher depending on temperature and duration of the cleaning cycle. SLRs of cycles without detergent are shown. ....	138
Figure 59: Standardized logarithmic reduction (SLR) in the dishwasher depending on temperature and duration of the cleaning cycle. SLRs of cycles with bleach-free detergent are shown. ....	139
Figure 60: Standardized logarithmic reduction (SLR) in the dishwasher depending on temperature and duration of the cleaning cycle. SLRs of cycles with activated oxygen-bleach (AOB)-containing detergent are shown. ....	140
Figure 61: Temperature profiles of different dishwasher cycles.....	143

## Appendix: List of tables

Table 1: Overview of microorganisms found in different foodstuffs. ....	3
Table 2: Overview of parameters measured, load, soil and if available microorganisms used in current standards for different types of dishwashers (Deutsches Institut für Normung e. V., 2019; International Electrotechnical Commission, 2015; Light-Industry Standard of the People’s Republic of China, 2013; NSF/ANSI 184-2019 - Residential Dishwashers, 2019) .....	17
Table 3: Information given on the energy label and the corresponding calculations. ....	22
Table 4: Exemplary calculations of the energy label for a device available on the market for the old and new energy labelling .....	26
Table 5: List of the microorganisms that have been used in the tests (ST = suspension tests, HDW = hand dishwashing tests, TGT = tergotometer tests, DW = dishwasher tests) with their respective ATCC and DSM numbers. Microorganisms marked with a superscript T are type strain microorganisms. Possible food sources and the respective references are given in the last column. ....	28
Table 6 Overview of the different soil matrices tested. Their composition and the soiling procedure is given.....	33
Table 7: Overview of the test parameters in the domestic dishwasher- each test organism was tested with every detergent type, cleaning cycle duration, cleaning cycle temperature and rinsing cycle temperature given.....	40
Table 8: Results of the heat resistance test of the different <i>M. luteus</i> strains. <i>E. faecium</i> DSM 2146 acted as positive control. None of the non-inoculated test tubes used as negative control showed any growth. ....	49
Table 9: Overview of several pre-tested soil matrices and the findings. ....	50
Table 10: Number of cross-contaminations detected after the extraction of stainless steel biomonitors from cleaning cycles in the dishwasher. Each number represents cross contaminations detected on nine biomonitors per condition. ....	113
Table 11: Overview of the logarithmic reductions (LR) achieved on biomonitors from different laboratories. Tests were carried out in the same appliance either in the respective laboratory (I) or with biomonitors from the respective laboratories but tests carried out centrally (II) with identical materials (III).....	114
Table 12: Comparison of SLRs from suspension tests (ST), tests in the tergotometer (TM) and in the dishwasher (DW) with AOB-containing detergent. Suspension test data are taken from literature (Amberg, 2018; IEC 53A WG3, 2019).....	122
Table 13: Overview of the parameters obtained from 4PL regression for <i>Ent. faecium</i> DSM 2146 and <i>M. luteus</i> DSM 1790 tests in the dishwasher. Only the test series	

with clear regression curves are included. All values were rounded to the third decimal place. ....	126
Table 14: Overview of the parameters obtained from 4PL regression for <i>Ent. faecium</i> DSM 2146 and <i>M. luteus</i> DSM 1790 tests in the dishwasher. All values were rounded to the third decimal place.....	127
Table 15: Overview of values received during random forest regression analysis for <i>Ent. faecium</i> DSM 2146 and <i>M. luteus</i> DSM 1790. ....	129
Table 16: Differences in the SLR between suspension tests and tests in the tergotometer. The detected differences may be caused by the mechanical action of the rotation and the attachment of the microbial load to the biomonitors. ....	133

## Appendix: Growth conditions for Microorganisms

**Table A1: Conditions used for the growth of the listed microorganisms. Type strains are indicated with a superscript T.**

strain	DSM number	incubation	
		temperature	duration
<i>Bacillus subtilis</i>	10 <sup>T</sup>	30 °C	48 h (+24 h)
<i>Campylobacter jejuni</i> subsp. <i>jejuni</i>	4688 <sup>T</sup>	37 °C microaerophilic	48 h (+24 h)
<i>Candida albicans</i>	1386	30 °C	48 h (+24 h)
<i>Enterococcus faecium</i>	2146	37 °C	24 h (+24 h)
<i>Escherichia coli</i>	682	37 °C	24 h (+24 h)
<i>Micrococcus luteus</i>	1790	30 °C	48 h (+24 h)
<i>Micrococcus luteus</i>	20030 <sup>T</sup>	30 °C	48 h (+24 h)
<i>Micrococcus luteus</i>	28269	30 °C	48 h (+24 h)
<i>Pseudomonas aeruginosa</i>	939	37 °C	24 h (+24 h)
<i>Salmonella enterica</i> subsp. <i>enterica</i> Serovar Typhimurium	5569	37 °C	24 h (+24 h)
<i>Staphylococcus aureus</i> subsp. <i>aureus</i>	799	37 °C	24 h (+24 h)

## Appendix: Culture media and other solutions

All solutions were prepared with ultrapure water (MQ water prepared with Q-Pod, Merck-Millipore, Darmstadt, Germany) and steam-sterilized at 121 °C and 200 kPa for 15 min prior to use. When this was not possible, the respective solutions were filter-sterilized (pore size 0.2 µm). Sterility controls of the solutions were performed in each experiment.

Dehydrated media were used where possible. In the following, the order information is given together with the typical composition. In cases, when no dehydrated media were available, the single components are given. Information about order numbers/ suppliers are given in Appendix: Materials and Devices

### Tryptic soy broth (TSB)

1.05459.0500 (Merck KGaA, Darmstadt, Germany), typical composition

component	amount (g·L <sup>-1</sup> )
pancreatic digest of casein	17.0
enzymatic digest of soy bean	3.0
sodium chloride	5.0
dipotassium hydrogen phosphate	2.5
dextrose	2.5
MQ water	<i>ad</i> 1000 mL
final pH	7.3 ±0.2

**Extraction liquid (EL)**

Tryptic Soy broth with inactivator was used in the experiments to antagonise effects of possible detergent residues. The extraction liquid was tested with all the detergents used to make sure that detergent effects were neutralized and that the extraction liquid itself does not affect the growth of the microorganisms.

<b>component</b>	<b>amount (g·L<sup>-1</sup>)</b>
tryptic soy broth	30.0
polysorbate 80/tween 80	30.0
lecithine	0.3
histidine	1.0
sodium thiosulphate	5.0
MQ water	<i>ad</i> 1000 mL

The extraction medium is sterilized in the autoclave; after sterilization, the medium is cooled under continuous stirring until it reaches room temperature; this should result in a clear solution. The medium is then stored in the refrigerator until use.

**Tryptic soy Agar (TSA)**

1.05458.0500 (Merck KGaA, Darmstadt, Germany), typical composition:

<b>component</b>	<b>amount (g·L<sup>-1</sup>)</b>
pancreatic digest of casein	15
enzymatic digest of soy bean	5
sodium chloride	5
Agar	15
MQ water	<i>ad</i> 1000 mL
final pH	7,3 ±0,2

**Soil matrix BAMS**

<b>component</b>	<b>amount (g·L<sup>-1</sup>)</b>
BSA (bovine serum albumin)	6
Mucin	10
Corn starch	30
MQ water	1000 mL

Mucin was dissolved in 650 mL MQ water and heated to 50 – 60 °C under continuous stirring on a magnetic stirrer with heating plate. To this, 6 g BSA were added. The solution was cooled to room temperature under continuous stirring.

At the same time, 260 mL sterile water was heated to the boiling point. The corn starch was dissolved in 90 mL sterile water and afterwards mixed with the boiling water. The solution was heated and stirred until it became visibly more viscous. The heat was then reduced and the solution was cooled to room temperature under continuous stirring. When both solutions had reached room temperature, they were mixed for a total of 1 L BAMS.

**Physiological sodium chloride solution (0.9% NaCl)**

Physiological sodium chloride solution was used as diluent in all dilution series. Sodium chloride is dissolved in MQ water and steam-sterilized.

<b>component</b>	<b>amount (g·L<sup>-1</sup>)</b>
sodium chloride	9
MQ water	<i>ad</i> 1000 mL

## Appendix: Detergent compositions

### Hand dishwashing detergent

chemical substance	Specification /CAS number	mass %
anionic surfactants	Alcohols, C12-14, ethoxylated, sulfates, sodium salts /68891-38-3	$\geq 5 < 10$
amphoteric surfactants	1-Propanaminium, 3-amino-N-(carboxymethyl)-N,N-dimethyl-, N-(C8-18 and C18-unsatd. acyl) derivates., inner salts /147170-44-3	$\geq 1 < 5$
preservative	2-methyl-2H-isothiazol-3-one /2682-20-4	
preservative	1,2-benzisothiazol-3(2H)-one /2634-33-5	
fragrances		



**Reference detergent type D**

<b>chemical substance</b>	<b>specification</b>	<b>mass %</b>
Sodium citrate dihydrate		30.0
Maleic acid/acrylic acid copolymer sodium salt	Sokalan CP5 Gran (BASF), 50% active on sodium carbonate	12.0
Sodium percarbonate*		7.0
Tetraacetyl ethylene diamine (TAED)*		2.0
Sodium disilicate		10.0
Linear fatty alcohol ethoxylate	Plurafac LF403 (BASF)	2.0
Protease	Savinase 16,0T 160KNPU/kg (Novozymes)	1.0
Amylase	Duramyl 120T, 600KNU/kg (Novozymes)	0.5
Sodium carbonate		balance to 100.0

\* For all experiments with bleach-free detergent (DT), the same basic formulation was used. From this basic formulation, all bleach components (sodium percarbonate and TAED) were removed, but the remaining formula was left unchanged. This resulted in the lower dose compared to the bleach-containing detergent.

**Rinse aid III**

<b>chemical substance</b>	<b>specification</b>	<b>mass %</b>
Linear fatty alcohol ethoxylate (non-ionic surfactant, low-foaming)	Plurafac LF 221/BASF	15.0
Cumene sulfonate	Steoven potate SCS/Steoven pot (40% solution in water)	11.5
Citric acid (anhydrous)		3.0
H <sub>2</sub> O	deionized water	balance to 100.0
Physical parameters:		
Viscosity [mpas]		17.0
pH (1% in water)		2.2

## Appendix: Materials and Devices

**Table A2: List of materials and devices that have been used including order number and supplier**

article	description	order number	supplier
BSA (bovines serum albumin)	albumin fraction V, $\geq 98\%$ for biochemistry and molecular biology	8076.2	Carl Roth GmbH + Co. KG, Karlsruhe, Germany
cell culture plate	6-well	83.3920.500	Sarstedt AG & Co. KG, Nümbrecht, Germany
constant climate chamber	HPP110	HPP110	Memmert GmbH, Schwabach, Germany
corn starch	extra pure	9444.1	Carl Roth GmbH + Co. KG, Karlsruhe, Germany
digital rocking shaker	Rocker 2D digital	0004003000	IKA®-Werke GmbH & CO. KG, Staufen, Germany
glass beads; soda lime glass	3 mm diameter	GTIN 4250317312334	Paul Marienfeld GmbH & Co KG, Lauda-Königshofen, Germany
glycerol	$\geq 99,5\%$ %, p.a., anhydrous	3783.3	Carl Roth GmbH + Co. KG, Karlsruhe, Germany
histidine	$\geq 98,5\%$ %, Ph. Eur., for biochemistry	3852.3	Carl Roth GmbH + Co. KG, Karlsruhe, Germany

article	description	order number	supplier
inoculation loop	10 µL, blue	86.1562.050	Sarstedt AG & Co. KG, Nümbrecht, Germany
inoculation spreader	Polystyrene, 4 pcs per bag	86.1569.005	Sarstedt AG & Co. KG, Nümbrecht, Germany
laboratory bottle DURAN®	25 mL, borosilicate glass 3.3, PP screw cap	215-1512	VWR International GmbH, Darmstadt, Germany
laboratory bottle DURAN®	50 mL, borosilicate glass 3.3, PP screw cap	215-1513	VWR International GmbH, Darmstadt, Germany
laboratory bottle DURAN®	100 mL, borosilicate glass 3.3, PP screw cap	215-1514	VWR International GmbH, Darmstadt, Germany
laboratory bottle DURAN®	250 mL, borosilicate glass 3.3, PP screw cap	215-1515	VWR International GmbH, Darmstadt, Germany
laboratory bottle DURAN®	500 mL, borosilicate glass 3.3, PP screw cap	215-1516	VWR International GmbH, Darmstadt, Germany
laboratory bottle DURAN®	1000 mL, borosilicate glass 3.3, PP screw cap	215-1517	VWR International GmbH, Darmstadt, Germany
lecithin	≥ 97% made from soy beans, for biochemistry	9812.1	Carl Roth GmbH + Co. KG, Karlsruhe, Germany

article	description	order number	supplier
magnetic stir bar	PTFE-coated magnetic stirring bars, cylindrical. 18 pieces, sorted	X171.1	Carl Roth GmbH + Co. KG, Karlsruhe, Germany
magnetic stirrer with heating plate	RH basic 2 IKAMAG®	0003339000	IKA®-Werke GmbH & CO. KG, Staufen, Germany
magnetic stirrer with heating plate	RSM-04H	RSM-04H	Phoenix Instrument, Garbsen, Germany
micro tube 1.5 mL	with attached lid, with moulded graduation and frosted writing space	72.690.001	Sarstedt AG & Co. KG, Nümbrecht, Germany
mucin		8494.1	Carl Roth GmbH + Co. KG, Karlsruhe, Germany
petri dish	92 x 16 mm, with ventilation cams	82.1473	Sarstedt AG & Co. KG, Nümbrecht, Germany
pipette tip 1000 µL	1000 µl, transparent, calibration rings	70.762.010	Sarstedt AG & Co. KG, Nümbrecht, Germany
pipette tip 1250 µL extra long	1250 µl, extra-long, transparent, calibration rings	70.1186.100	Sarstedt AG & Co. KG, Nümbrecht, Germany
pipette tip 200 µL	200 µl, transparent, calibration rings	70.760.002	Sarstedt AG & Co. KG, Nümbrecht, Germany
pipette tip 200 µL extra long	200 µl, transparent, calibration rings, extra long	70.1189.105	Sarstedt AG & Co. KG, Nümbrecht, Germany

article	description	order number	supplier
pipette tip 5 mL	0.1 - 5 ml, transparent, calibration rings	70.1181.002	Sarstedt AG & Co. KG, Nümbrecht, Germany
polysorbate 80/tween 80	Ph. Eur.	9139.3	Carl Roth GmbH + Co. KG, Karlsruhe, Germany
screw cap tube	50 mL, 114 x 28 mm, conical base, PP, sterile	62.547.254	Sarstedt AG & Co. KG, Nümbrecht, Germany
screw cap tube	15 ml, 120 x 17 mm, conical base, PP, sterile	62.554.502	Sarstedt AG & Co. KG, Nümbrecht, Germany
serological pipette	10 ml, with cotton plug	86.1254.001	Sarstedt AG & Co. KG, Nümbrecht, Germany
serological pipette	25 ml, with cotton plug	86.1685.001	Sarstedt AG & Co. KG, Nümbrecht, Germany
sodium chloride	≥ 99.5 %, for molecular biology	A3597,5000	AppliChem GmbH, Darmstadt, Germany
sodium thiosulphate	≥99 %, p.a., anhydrous	HN25.1	Carl Roth GmbH + Co. KG, Karlsruhe, Germany
stainless steel biomonitors	for details see materials and methods section	81-001-00	H-S Feinblechbau GmbH, August-Bebel-Straße 10 a, 07646 Stadtroda (Thüringen), Germany

article	description	order number	supplier
stainless steel coupons	20 mm diameter		GK Formblech GmbH, Säntisstraße 133, 12277 Berlin, Germany
sterile syringe filters	Luer lock, PES membrane, 0.2 µm pore size	83.1826.001	Sarstedt AG & Co. KG, Nümbrecht, Germany
temperature logger	TELID® 311	TELID 311	Microsensus, Erfurt, Germany
test tube caps	17/18 mm, blue	6602111	Paul Marienfeld GmbH & Co KG, Lauda-Königshofen, Germany
test tube, AR®/soda glass with screw cap	160 mm length, 16 mm diameter	WITG2.585.003	WITEG Labortechnik GmbH, Wertheim, Germany
test tubes	without rim, 180 mm length, 18 mm diameter	212-0020	VWR International GmbH, Darmstadt, Germany
tilt-/ roller mixer	IKA® Roller 10 digital	0004013000	IKA®-Werke GmbH & CO. KG, Staufen, Germany
tryptic soy agar	dehydrated, granulated	1.05458.0500	Merck KGaA, Darmstadt, Germany
tryptic soy broth	dehydrated, granulated	1.05459.0500	Merck KGaA, Darmstadt, Germany
ultra sound bath	USC900TH	142-0099	VWR International GmbH, Darmstadt, Germany

article	description	order number	supplier
vortex mixer	VortexGenie® 2	SI-0256 230V	Scientific Industries, Bohemia, New York, USA
wet abrasion scrub tester	Ref 903/PG	903/PG	Sheen Instruments, Cambridge, UK



**Appendix: Matrix pre-test results**

1. after dishwashing cycles with a cleaning temperature of 45 °C, a cleaning duration of 15 min and a rinsing temperature of 50 °C, different reductions were observed on different materials. The initial counts varied up to 2 logarithmic steps under identical conditions on different items of the same material.
2. after a 10 min cleaning cycle in the dishwasher without detergent at the lowest possible cleaning temperature of 45 °C and a rinsing temperature of 45 °C, no microorganisms could be detected on the soiled biomonitors with constant initial counts for a single microorganism but variations between different microorganisms.
3. after a 10 min cleaning cycle in the dishwasher without detergent at the lowest possible cleaning temperature of 45 °C and a rinsing temperature of 45 °C, no microorganisms could be detected on the soiled plates with constant initial counts independent of the drying duration
4. after a 10 min cleaning cycle in the dishwasher without detergent at the lowest possible cleaning temperature of 45 °C and a rinsing temperature of 45 °C, no microorganisms could be detected on the soiled plates with constant initial counts independent of the drying duration
5. no determination possible, neither initial count nor remaining count; no survival of test-microorganism but singular detections of *Bacillus* spp.
6. no determination possible, neither initial count nor remaining count; no survival of test-microorganism but singular detections of *Bacillus* spp.
7. high variations in initial counts as well as in remaining counts after short, low temperature cleaning cycle; most consistent numbers with condensed milk dried at room temperature; initial counts too low for experiments
8. relatively low initial counts (decrease during drying process compared to second soiling agent solution)
9. initial count of  $1 \times 10^6$  cfu · mL<sup>-1</sup> is too low for experiments and no microorganisms detected after short, low temperature cleaning cycle.
10. initial count of  $9 \times 10^8$  cfu · mL<sup>-1</sup> is high enough for tests, higher survival rate on cooled compared to frozen storage; remaining count after short, low temperature cleaning cycle without detergent shows some remaining cells

11. initial count of  $9 \times 10^8$  cfu · mL<sup>-1</sup> is high enough for tests, higher survival rate on cooled compared to frozen storage; remaining count after short, low temperature cleaning cycle without detergent shows some remaining cells
12. the higher the CaCl<sub>2</sub> concentration, the lower the initial count on the biomonitor; high variation in initial counts on biomonitors; only singular events of remaining count on biomonitor
13. initial count of  $5 \times 10^7$  cfu · mL<sup>-1</sup> is a bit low; no recovery of microorganisms after low cleaning cycle in dishwasher with cleaning temperature of 45 °C, a cleaning duration of 15 min without detergent
14. initial counts of 1 to  $1.5 \times 10^9$  cfu · mL<sup>-1</sup>; remaining counts vary depending on cleaning temperature, detergent use, duration and test microorganism

Appendix: Full-size figures

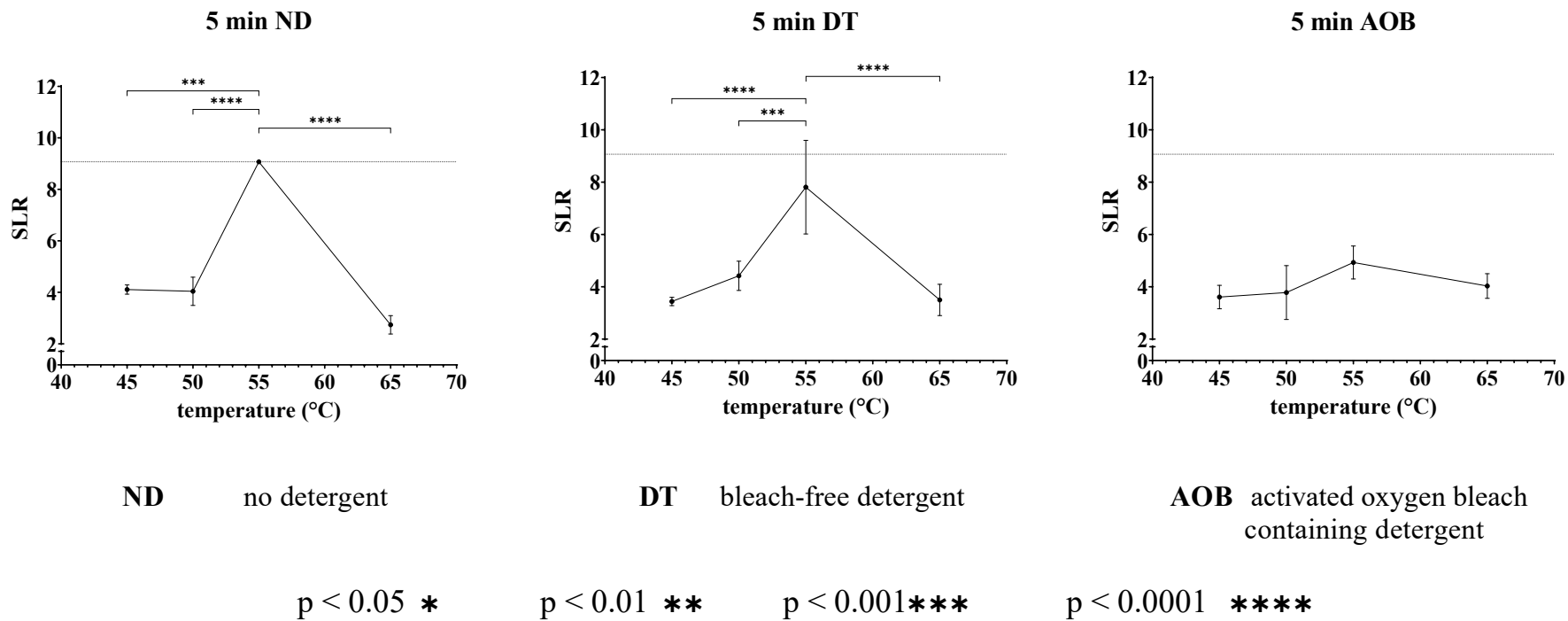
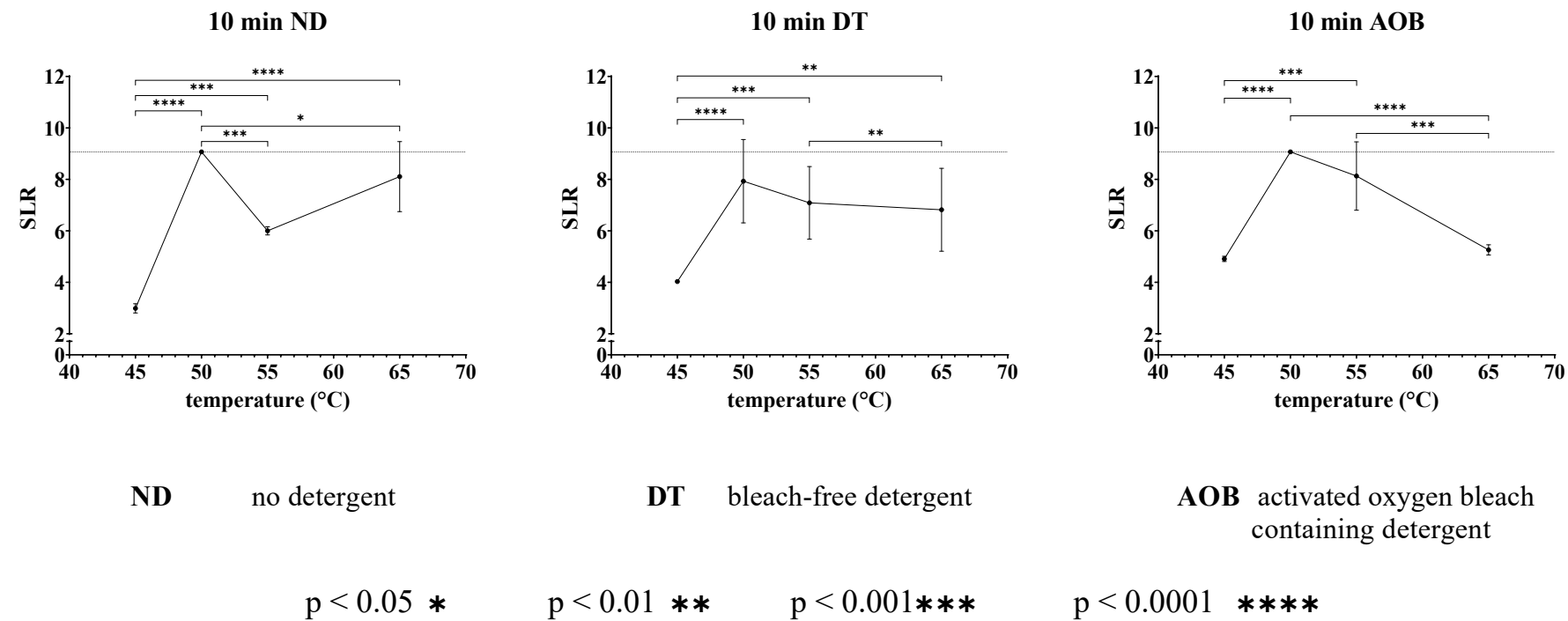
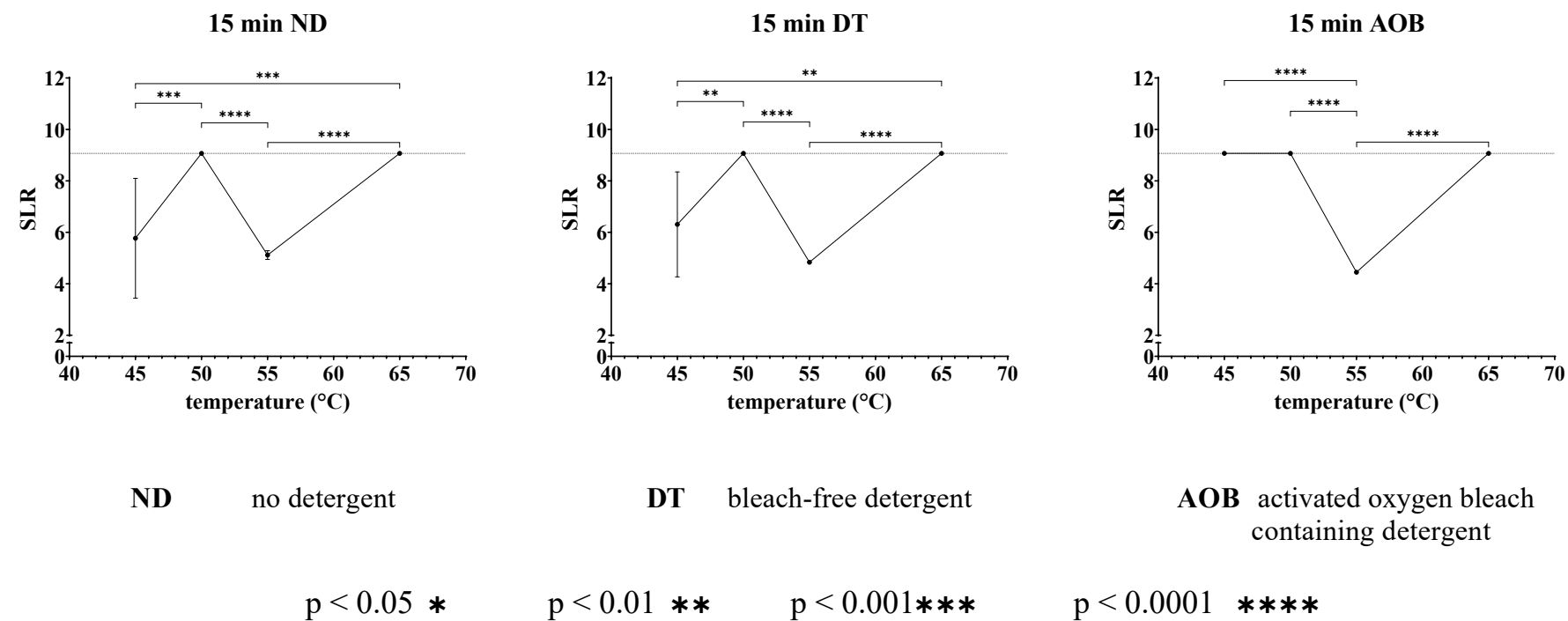

Figure 19.1: Overview of the standardized logarithmic reductions of *Ent. faecium* DSM 2146 on biomonitors. The dotted lines indicate the maximum SLR. Statistically significant differences in SLRs between different temperatures are marked with asterisks.



**Figure 19.2: Overview of the standardized logarithmic reductions of *Ent. faecium* DSM 2146 on biomonitors. The dotted lines indicate the maximum SLR. Statistically significant differences in SLRs between different temperatures are marked with asterisks.**



**Figure 19.3: Overview of the standardized logarithmic reductions of *Ent. faecium* DSM 2146 on biomonitors. The dotted lines indicate the maximum SLR. Statistically significant differences in SLRs between different temperatures are marked with asterisks.**

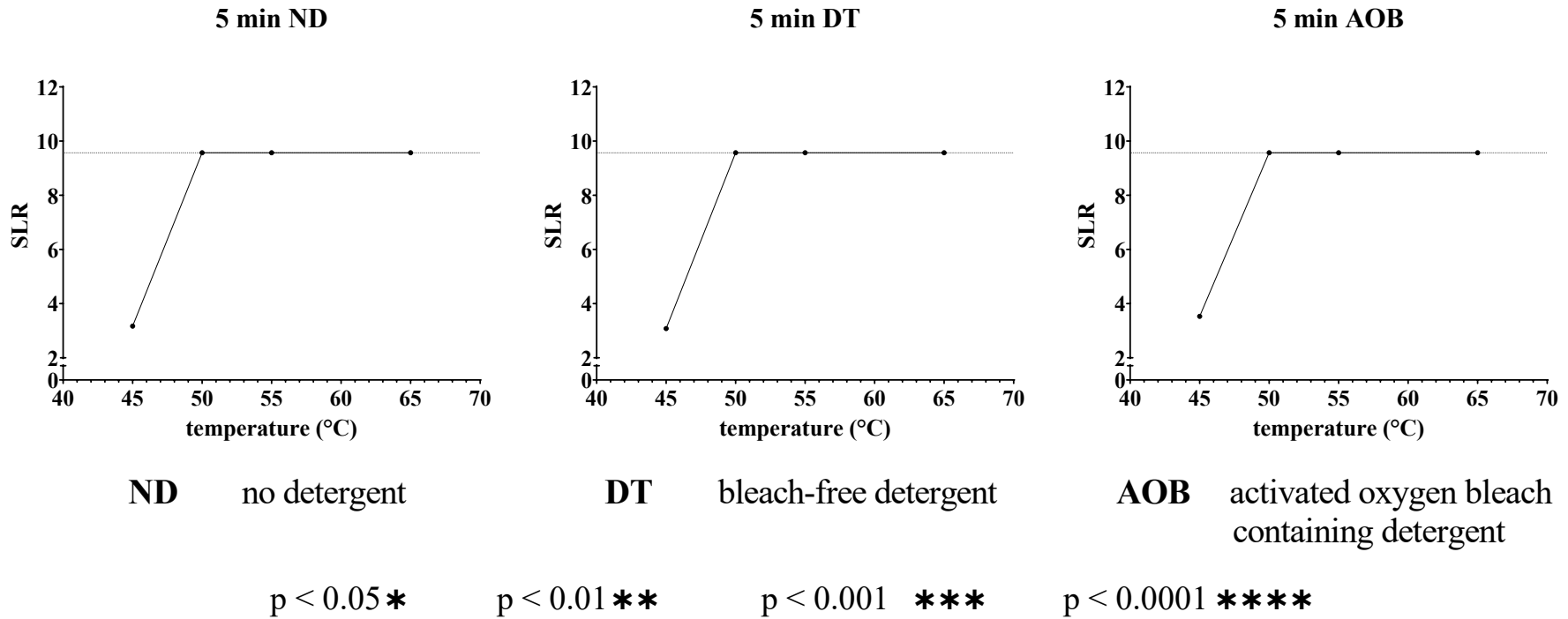

**Figure 20.1: Overview of the standardized logarithmic reductions (SLR) of *Ent. faecium* DSM 2146 in the water. The dotted lines indicate the maximum SLR. No standard deviations or significances are given due to the small sample size.**

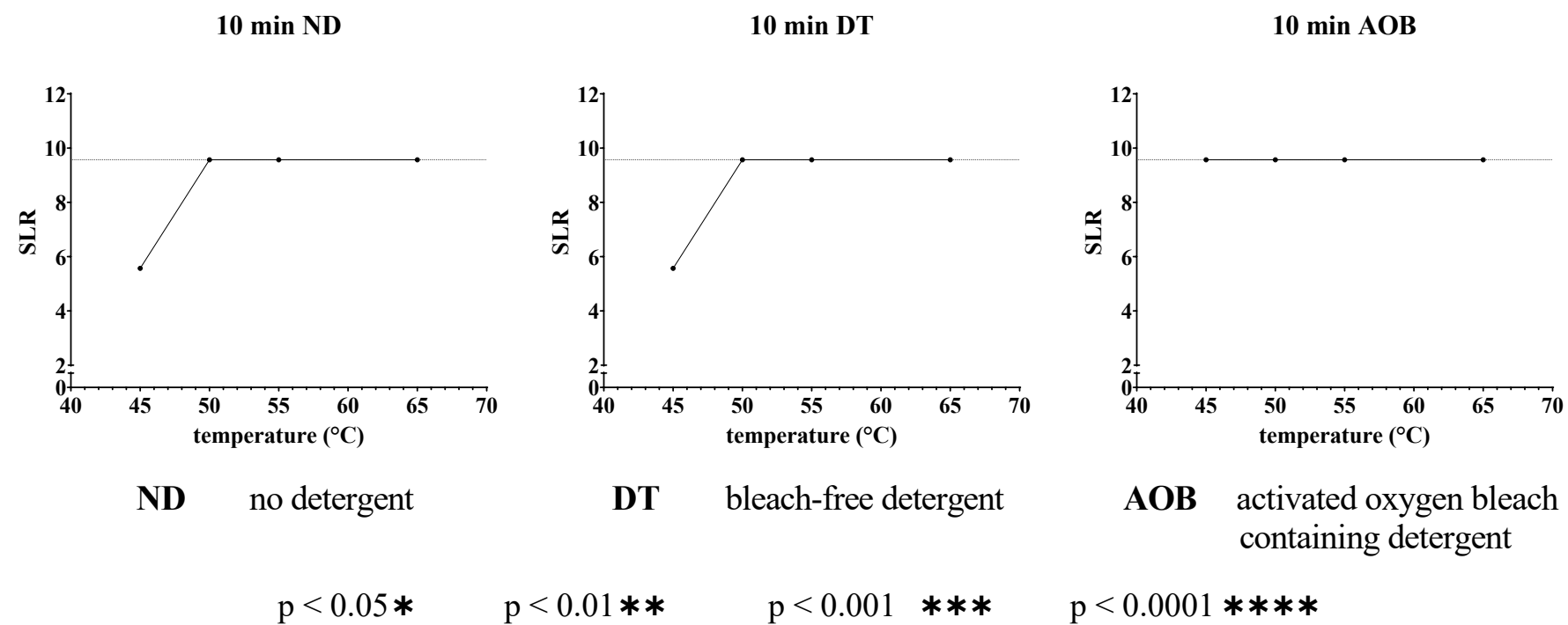
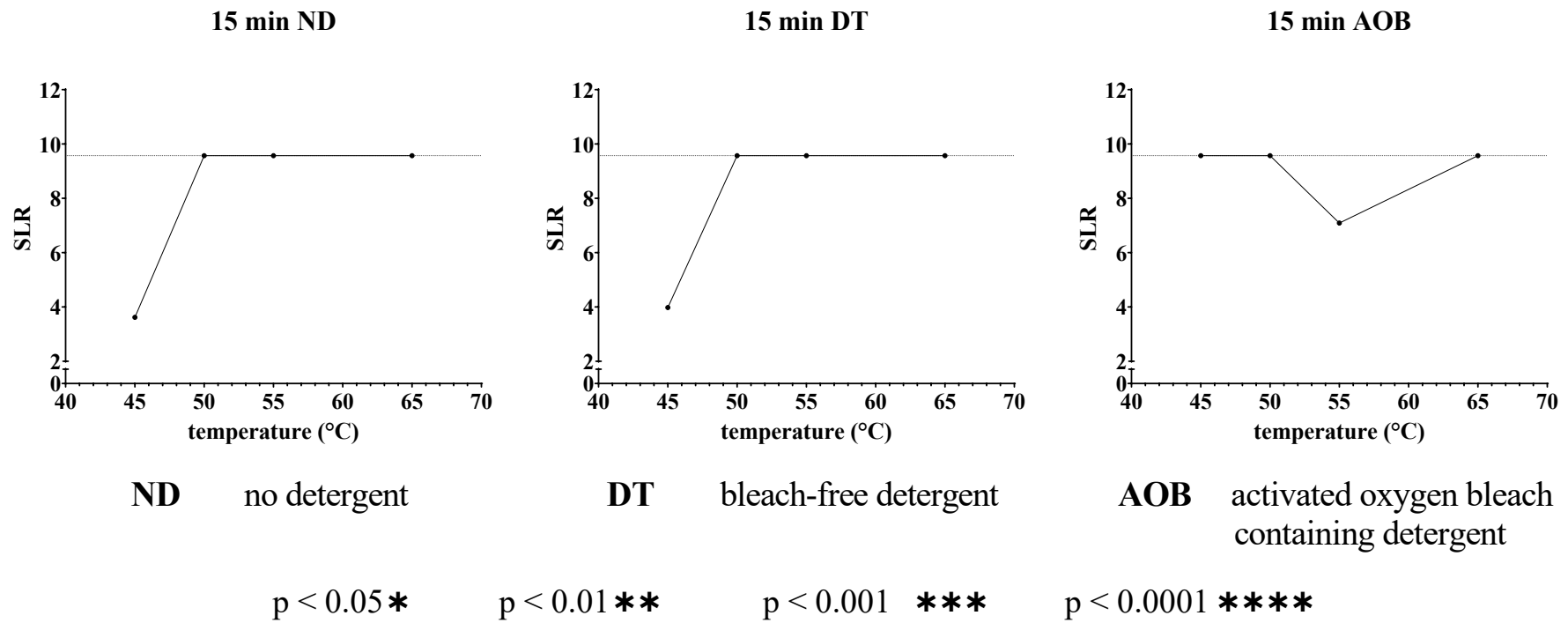
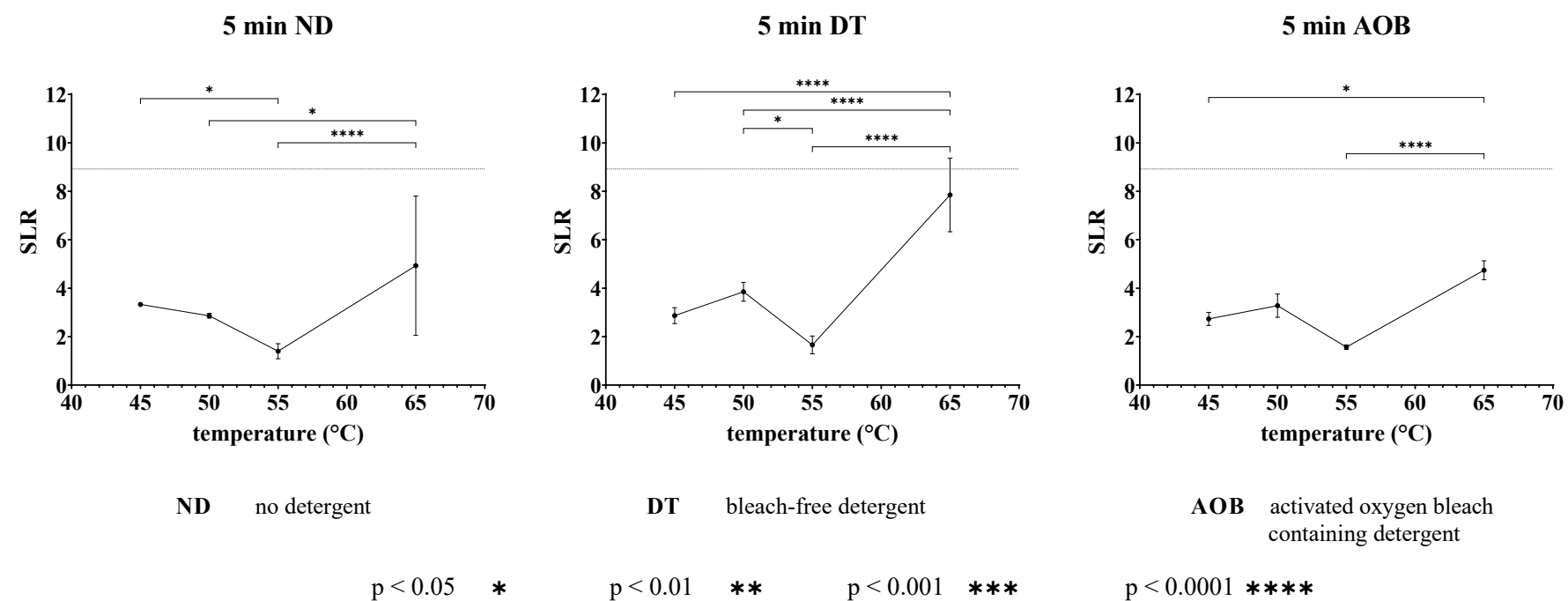

Figure 20.2: Overview of the standardized logarithmic reductions (SLR) of *Ent. faecium* DSM 2146 in the water. The dotted lines indicate the maximum SLR. No standard deviations or significances are given due to the small sample size.

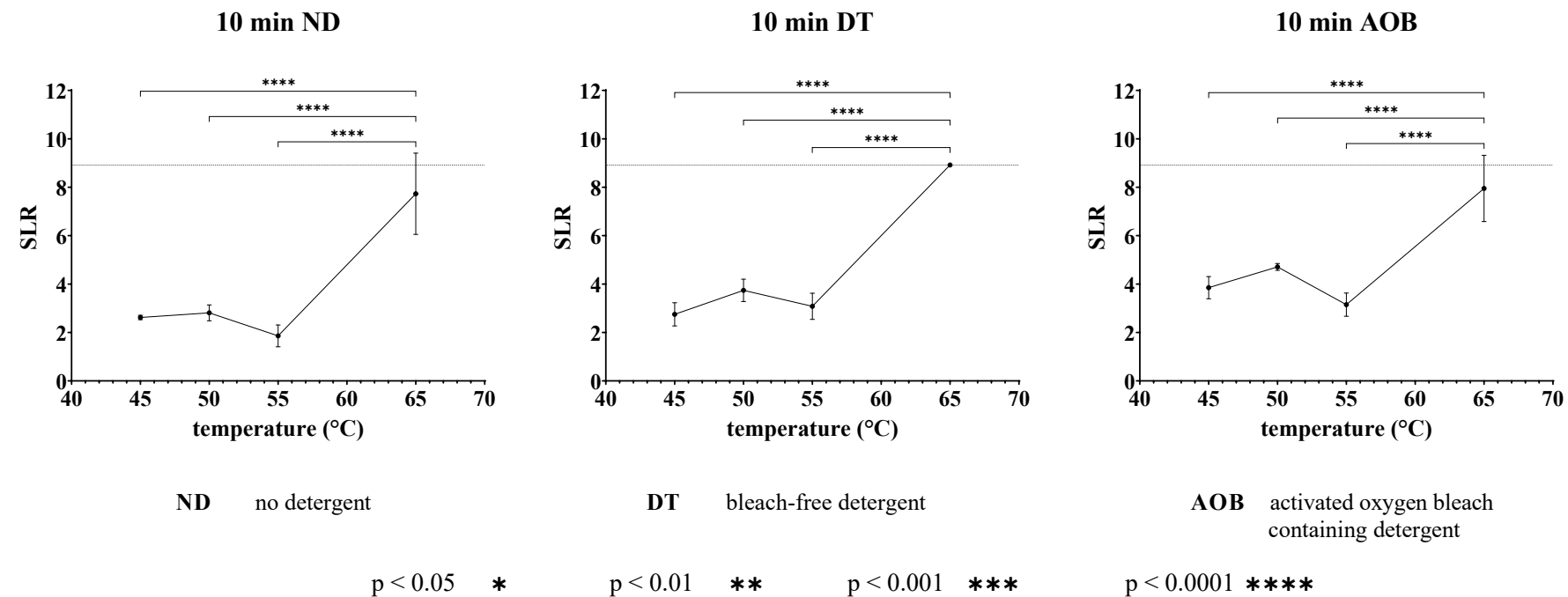

**Figure 20.3: Overview of the standardized logarithmic reductions (SLR) of *Ent. faecium* DSM 2146 in the water. The dotted lines indicate the maximum SLR. No standard deviations or significances are given due to the small sample size.**

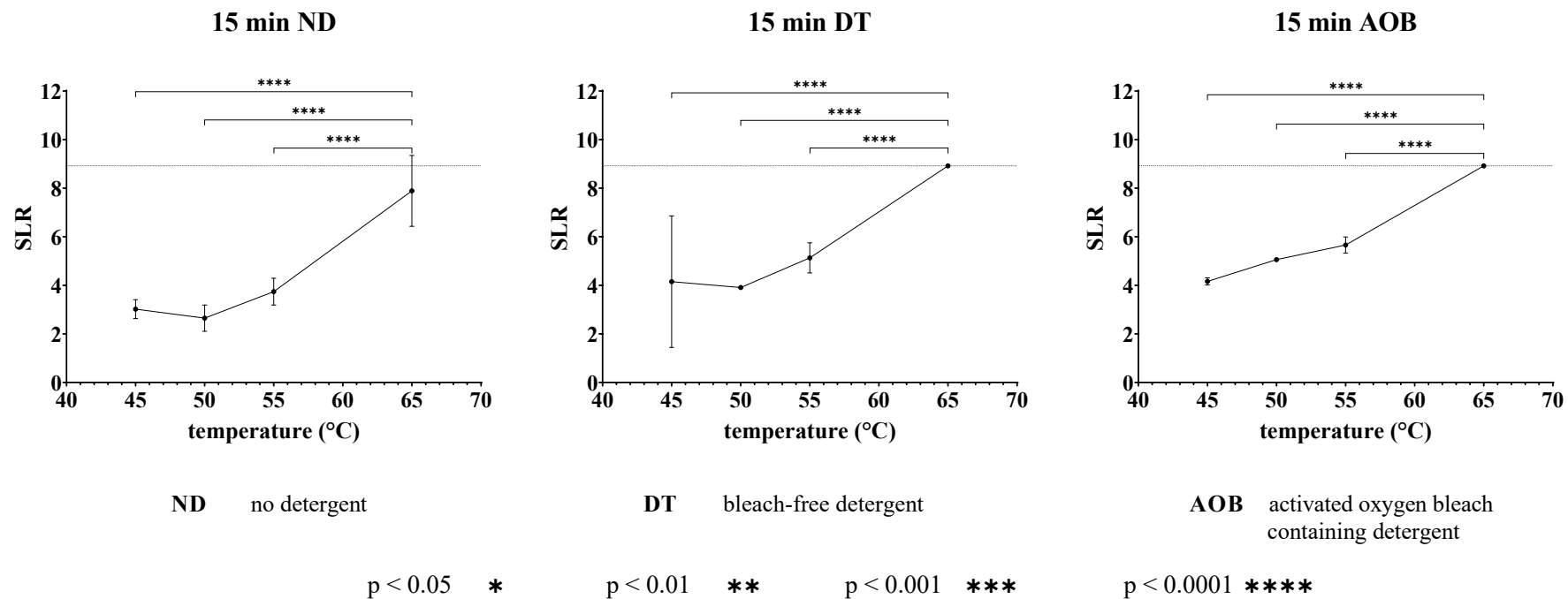



**Figure 21.1: Overview of the standardized logarithmic reductions of *M. luteus* DSM 1790 on biomonitors. The dotted lines indicate the maximum SLR. Statistically significant differences in SLRs between different temperatures are marked with asterisks.**



**Figure 21.2: Overview of the standardized logarithmic reductions of *M. luteus* DSM 1790 on biomonitors. The dotted lines indicate the maximum SLR. Statistically significant differences in SLRs between different temperatures are marked with asterisks.**



**Figure 21.3: Overview of the standardized logarithmic reductions of *M. luteus* DSM 1790 on biomonitors. The dotted lines indicate the maximum SLR. Statistically significant differences in SLRs between different temperatures are marked with asterisks.**

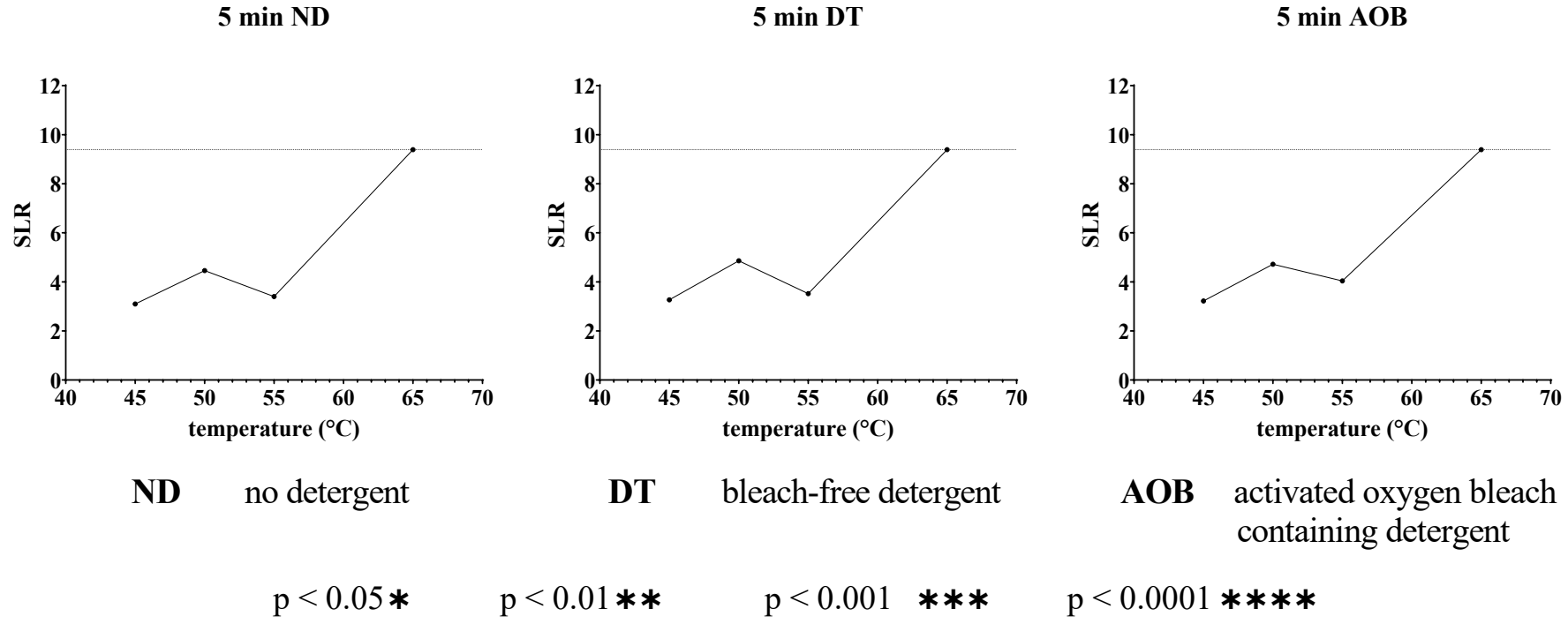

**Figure 22.1: Overview of the standardized logarithmic reductions (SLR) of *M. luteus* DSM 1790 in the water. The dotted lines indicate the maximum SLR. No standard deviations or significances are given due to the small sample size.**

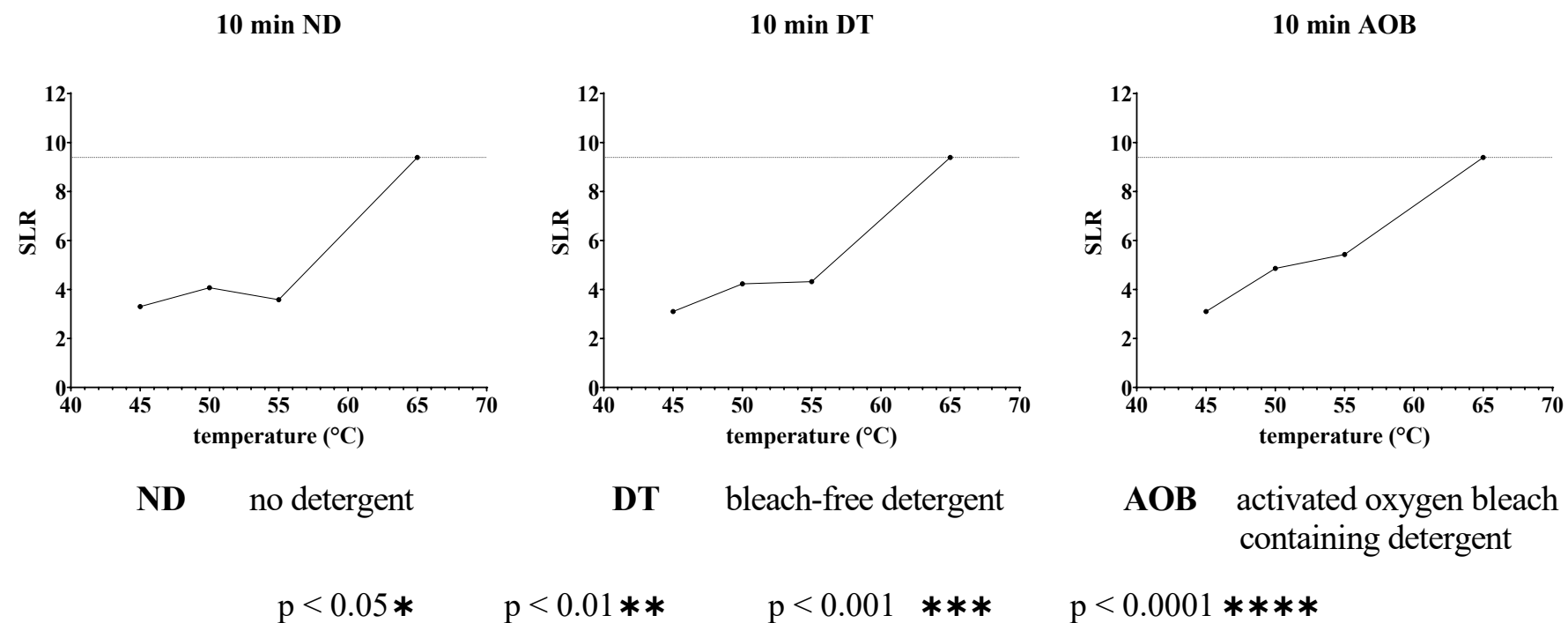

Figure 22.2: Overview of the standardized logarithmic reductions (SLR) of *M. luteus* DSM 1790 in the water. The dotted lines indicate the maximum SLR. No standard deviations or significances are given due to the small sample size.

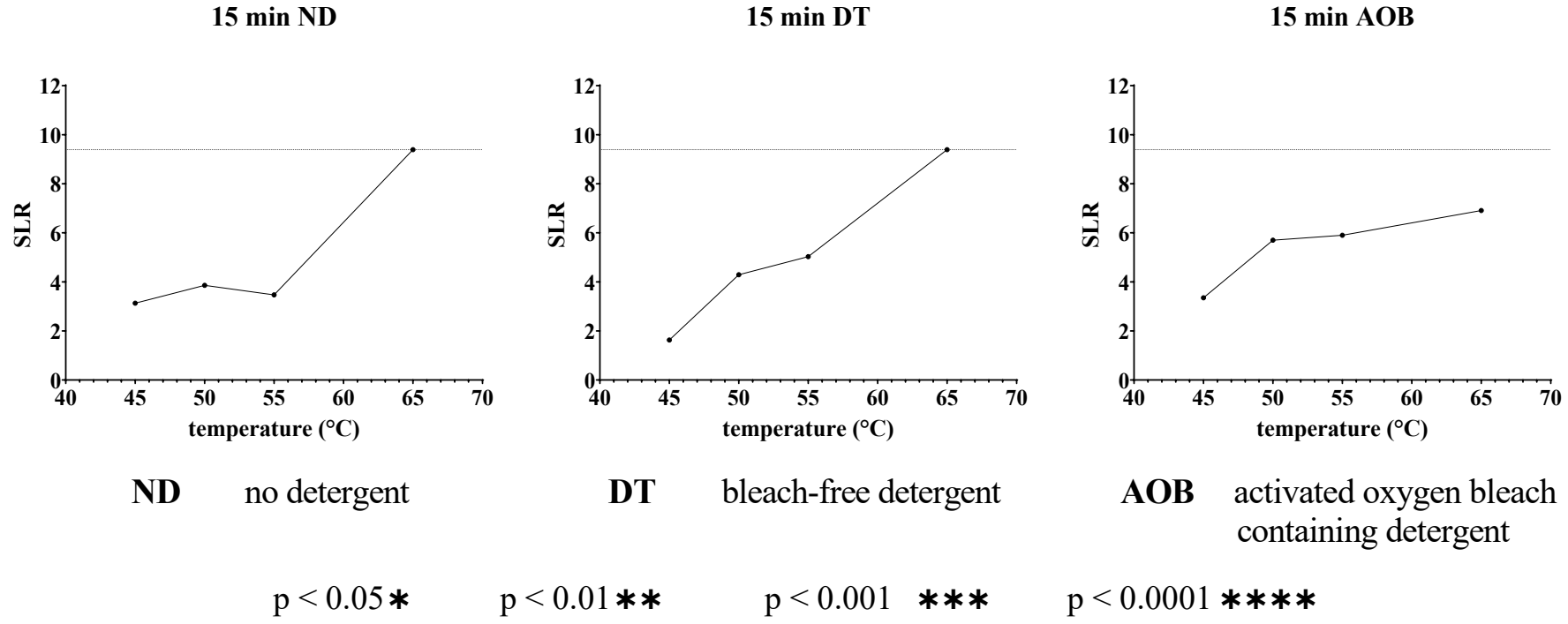

Figure 22.3: Overview of the standardized logarithmic reductions (SLR) of *M. luteus* DSM 1790 in the water. The dotted lines indicate the maximum SLR. No standard deviations or significances are given due to the small sample size.

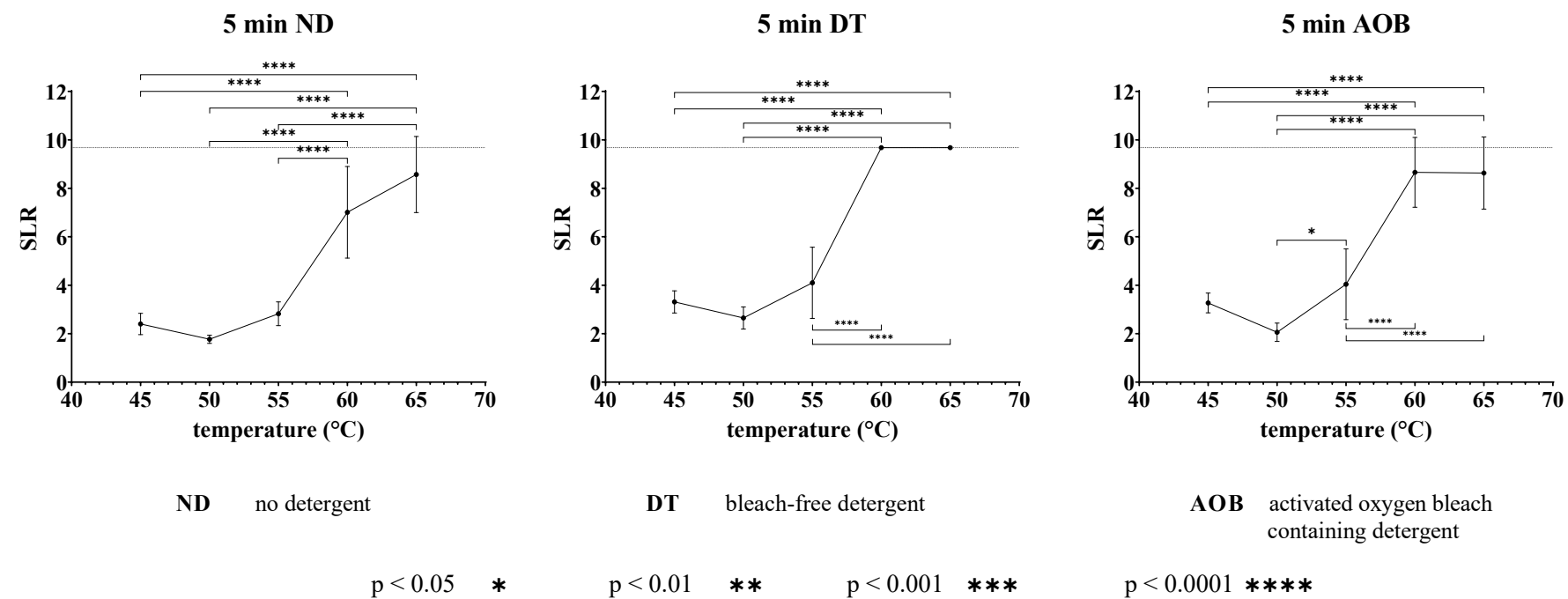
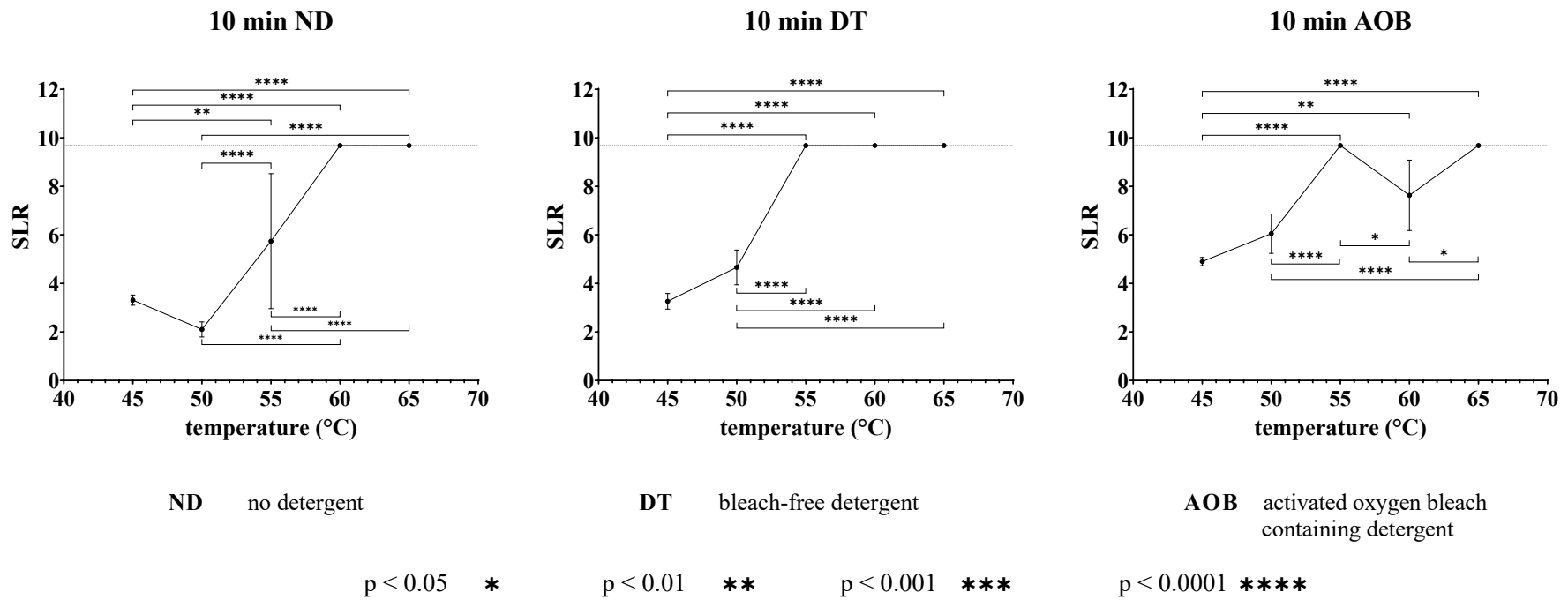
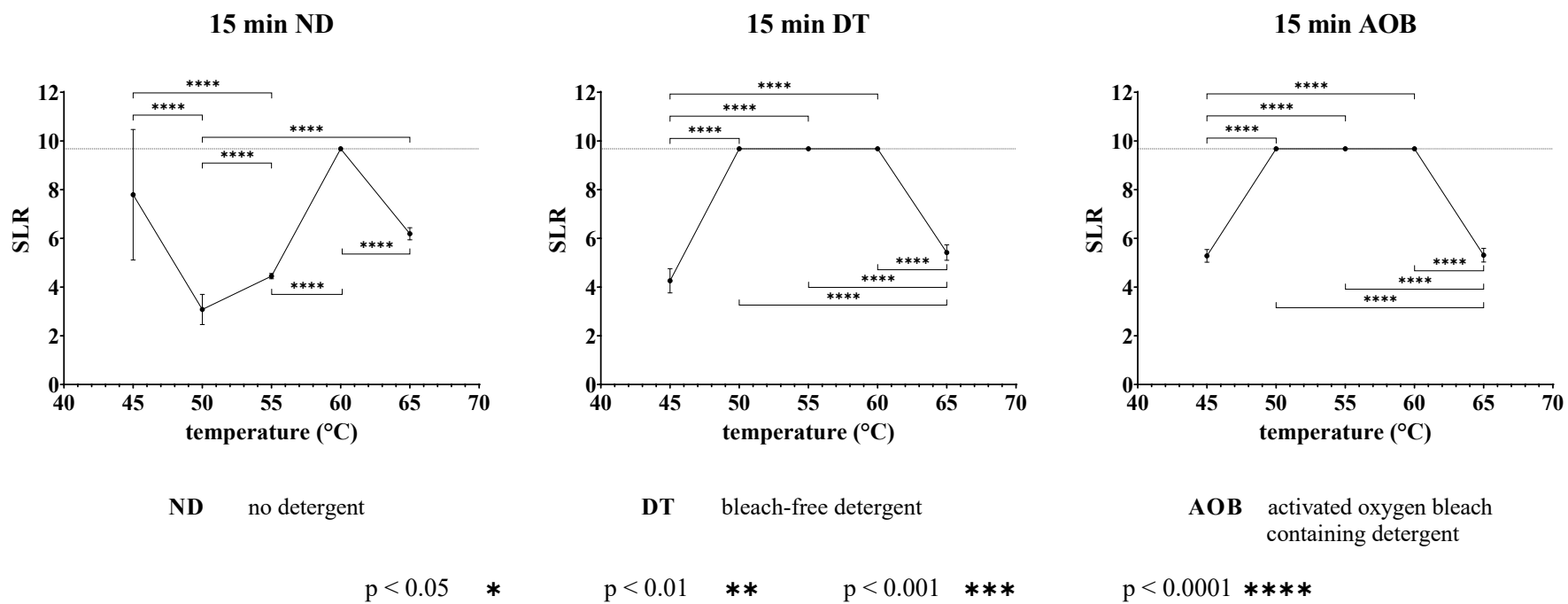

Figure 23.1: Overview of the standardized logarithmic reductions of *S. aureus* DSM 939 on biomonitors. The dotted lines indicate the maximum SLR. Statistically significant differences in SLRs between different temperatures are marked with asterisks.



**Figure 23.2: Overview of the standardized logarithmic reductions of *S. aureus* DSM 939 on biomonitors. The dotted lines indicate the maximum SLR. Statistically significant differences in SLRs between different temperatures are marked with asterisks.**





**Figure 23.3: Overview of the standardized logarithmic reductions of *S. aureus* DSM 939 on biomonitors. The dotted lines indicate the maximum SLR. Statistically significant differences in SLRs between different temperatures are marked with asterisks.**

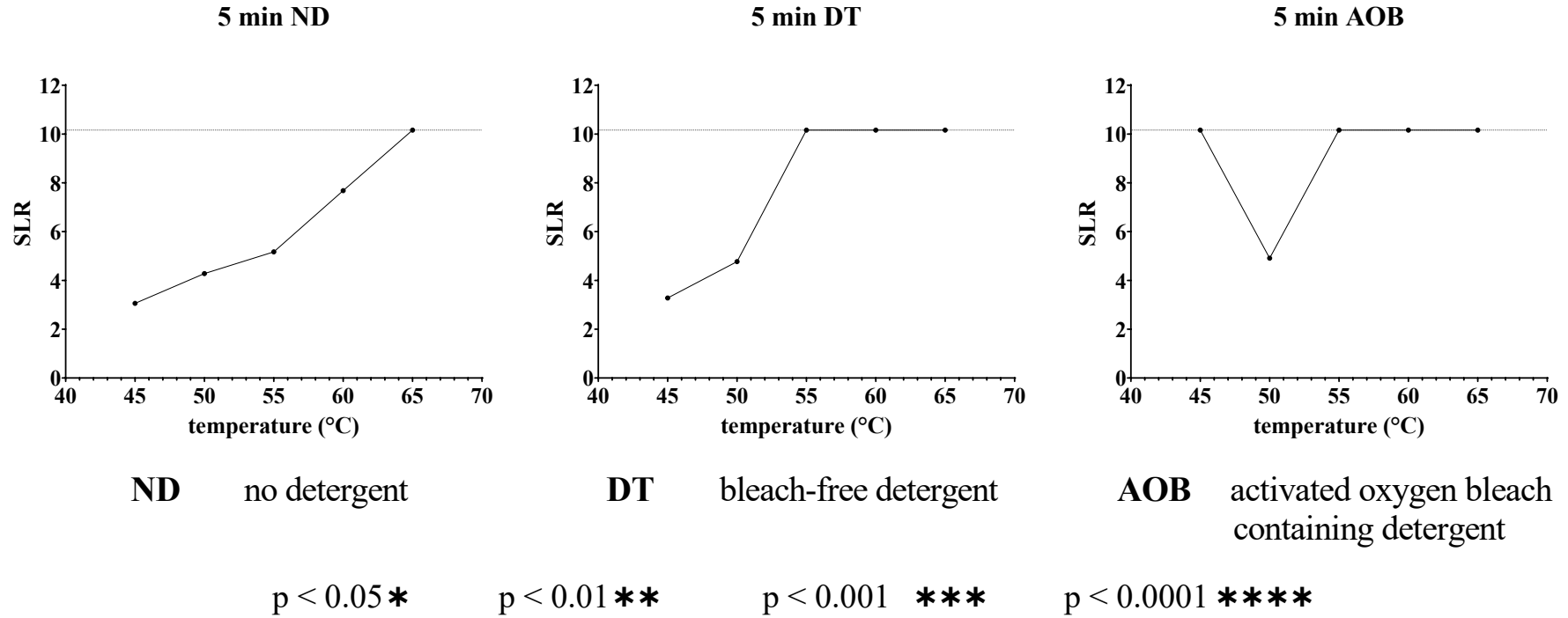

Figure 24.1: Overview of the standardized logarithmic reductions (SLR) of *S. aureus* DSM 939 in the water. The dotted lines indicate the maximum SLR. No standard deviations or significances are given due to the small sample size.

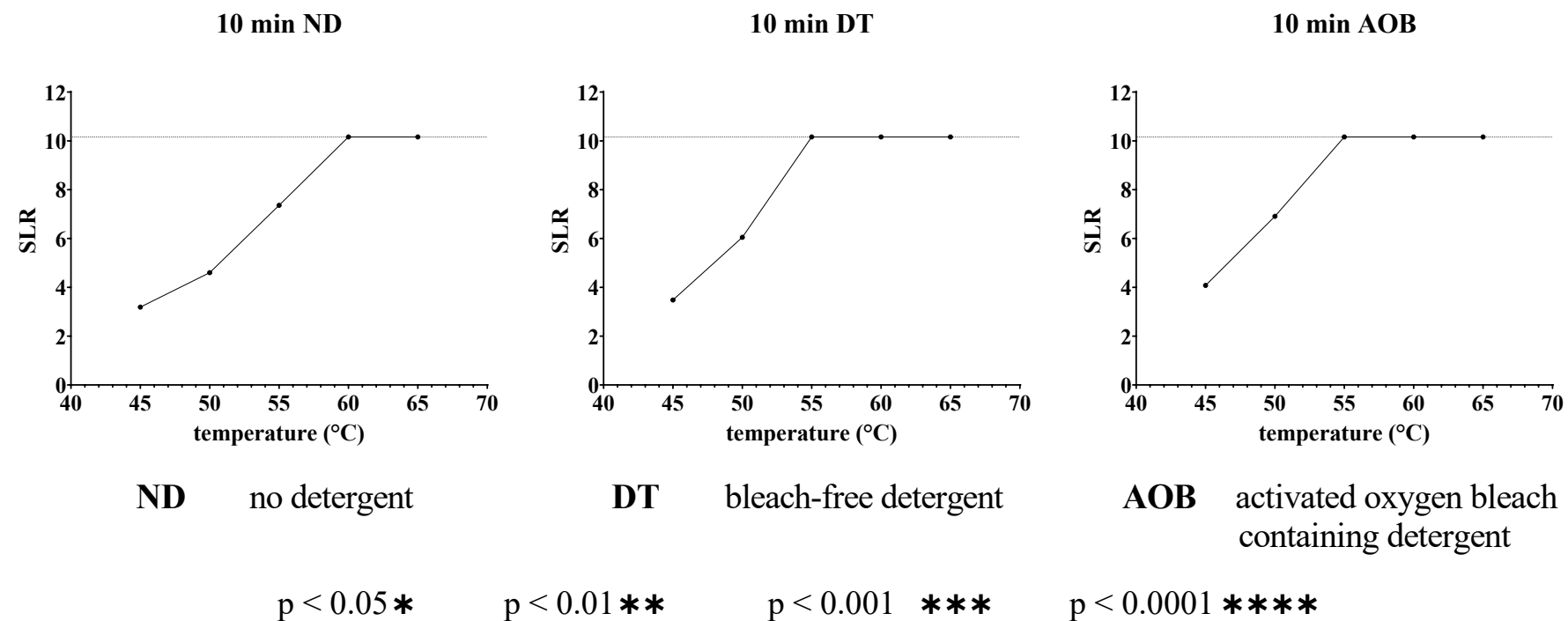

Figure 24.2: Overview of the standardized logarithmic reductions (SLR) of *S. aureus* DSM 939 in the water. The dotted lines indicate the maximum SLR. No standard deviations or significances are given due to the small sample size.

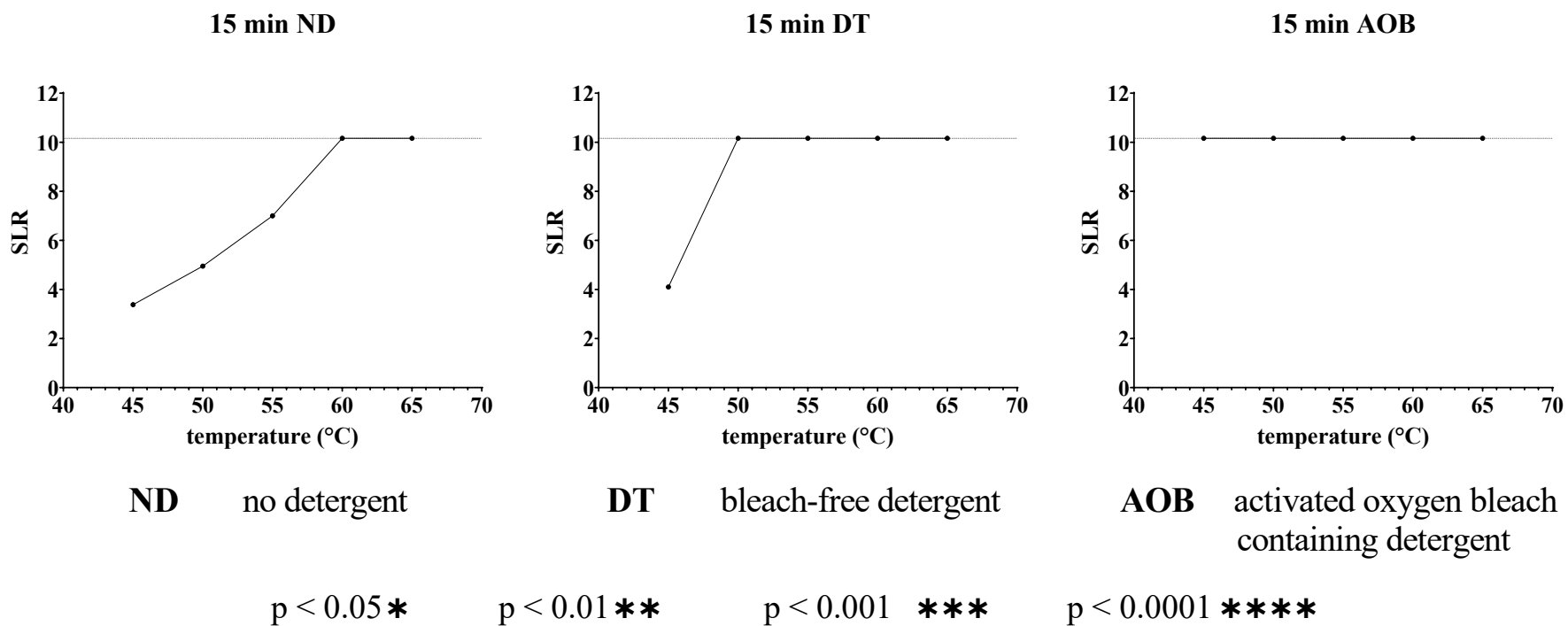

Figure 24.3: Overview of the standardized logarithmic reductions (SLR) of *S. aureus* DSM 939 in the water. The dotted lines indicate the maximum SLR. No standard deviations or significances are given due to the small sample size.

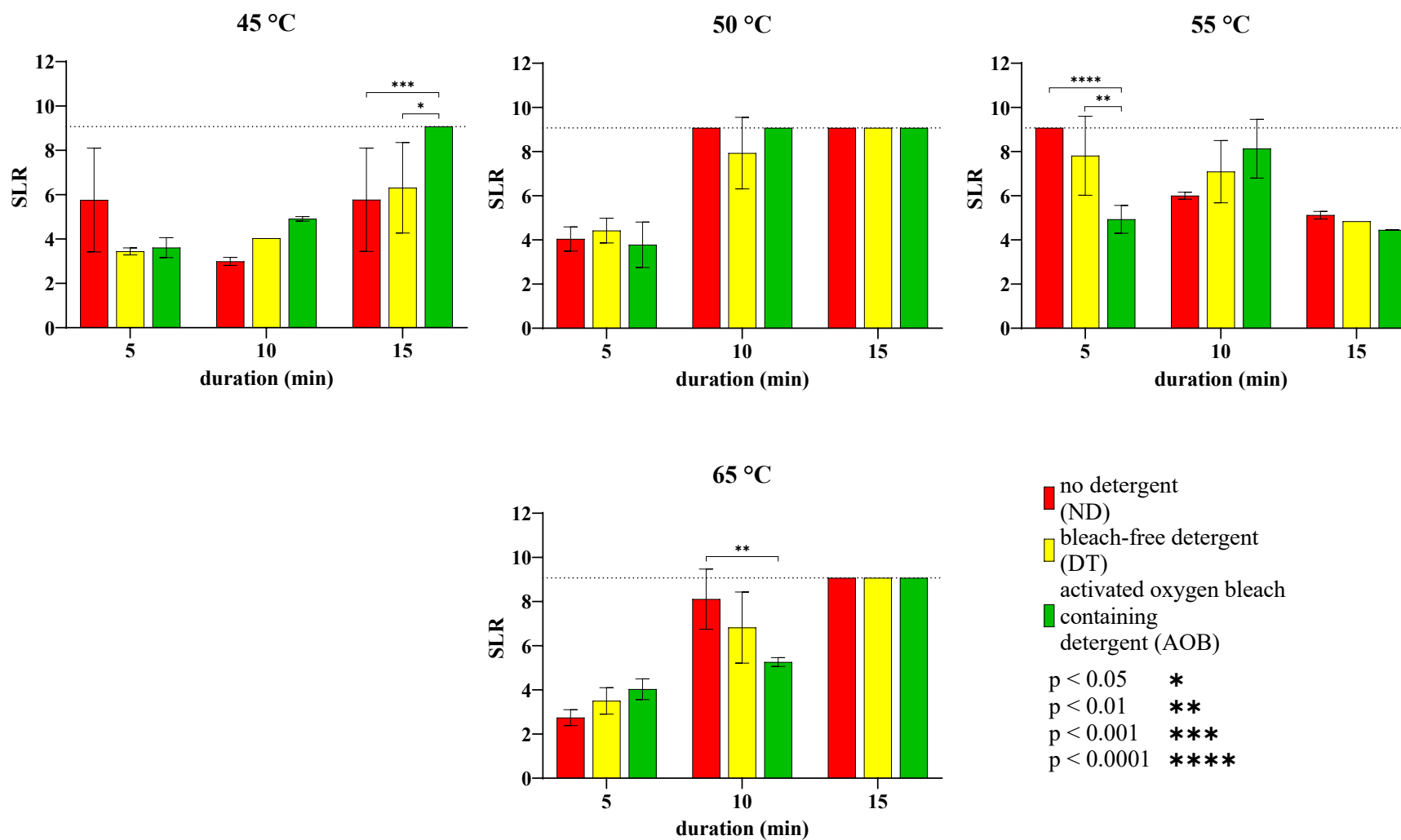
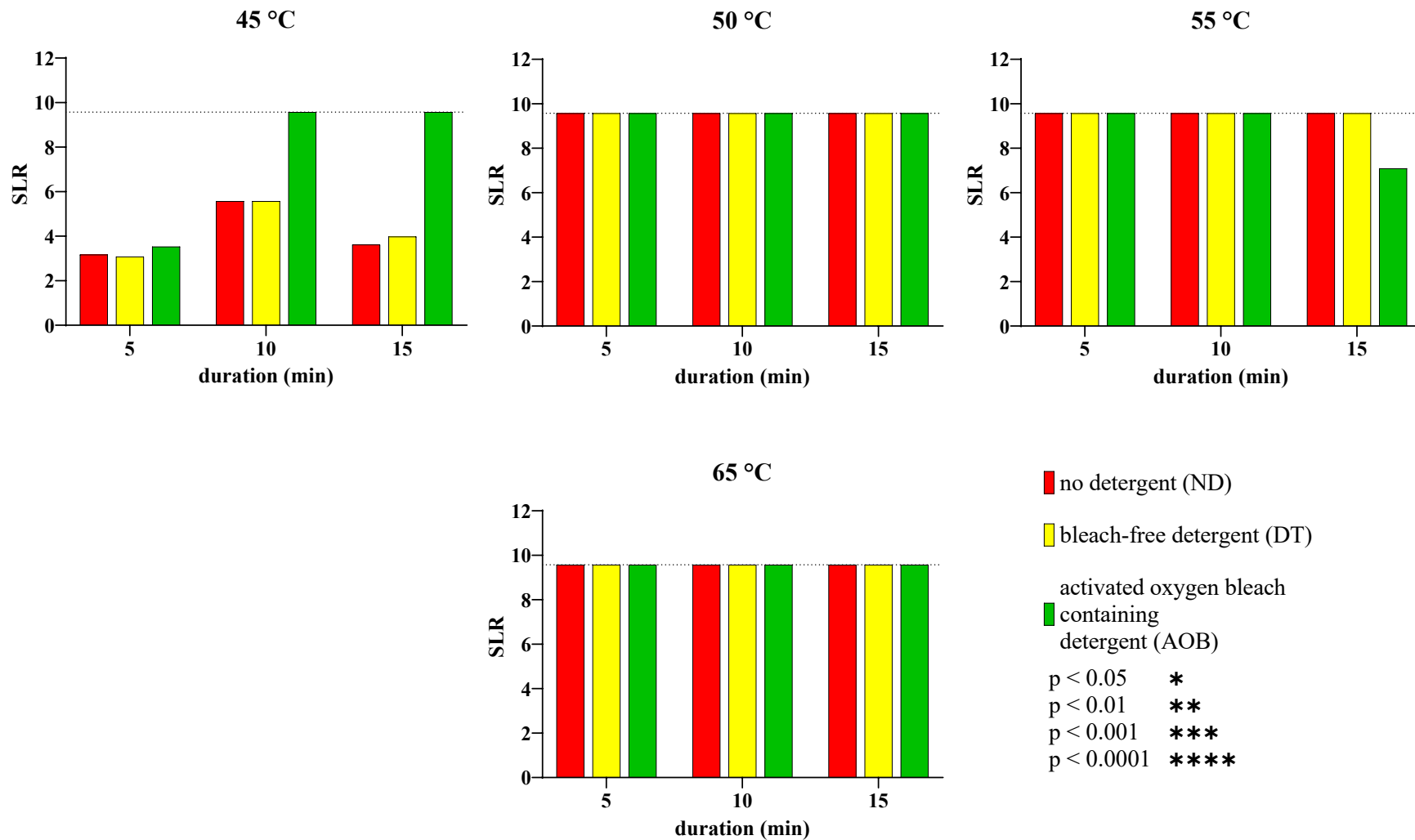

Figure 25: SLR on biomonitors inoculated with *Ent. faecium* DSM 2146 after tests in the tergotometer with the given parameters. Statistically significant differences caused by a change in the detergent are marked with asterisks.



**Figure 26: Overview of the standardized logarithmic reductions (SLR) of *Ent. faecium* DSM 2146 in the water. The dotted lines indicate the maximum SLR. No standard deviations or significances are given due to the small sample size.**

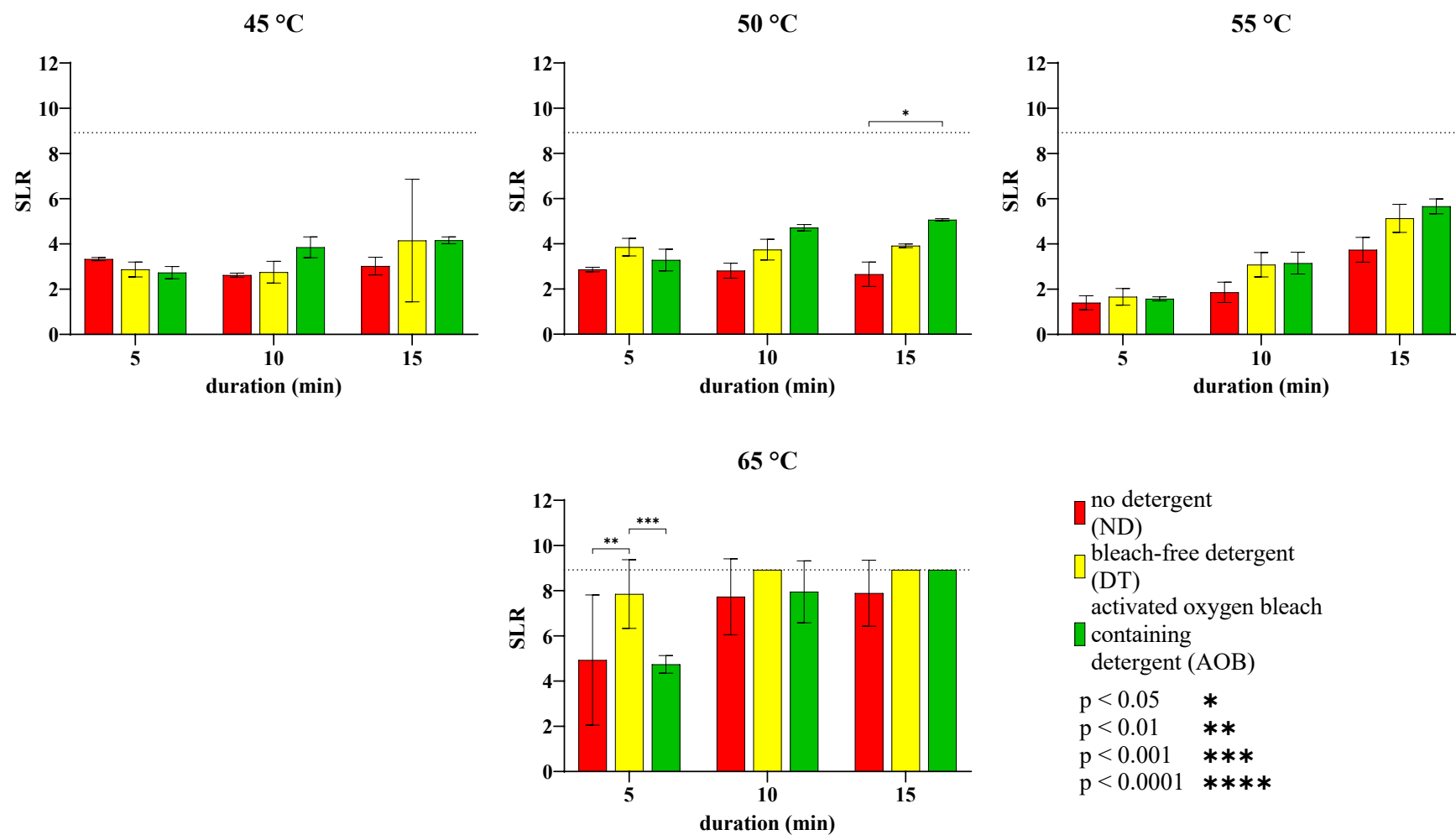
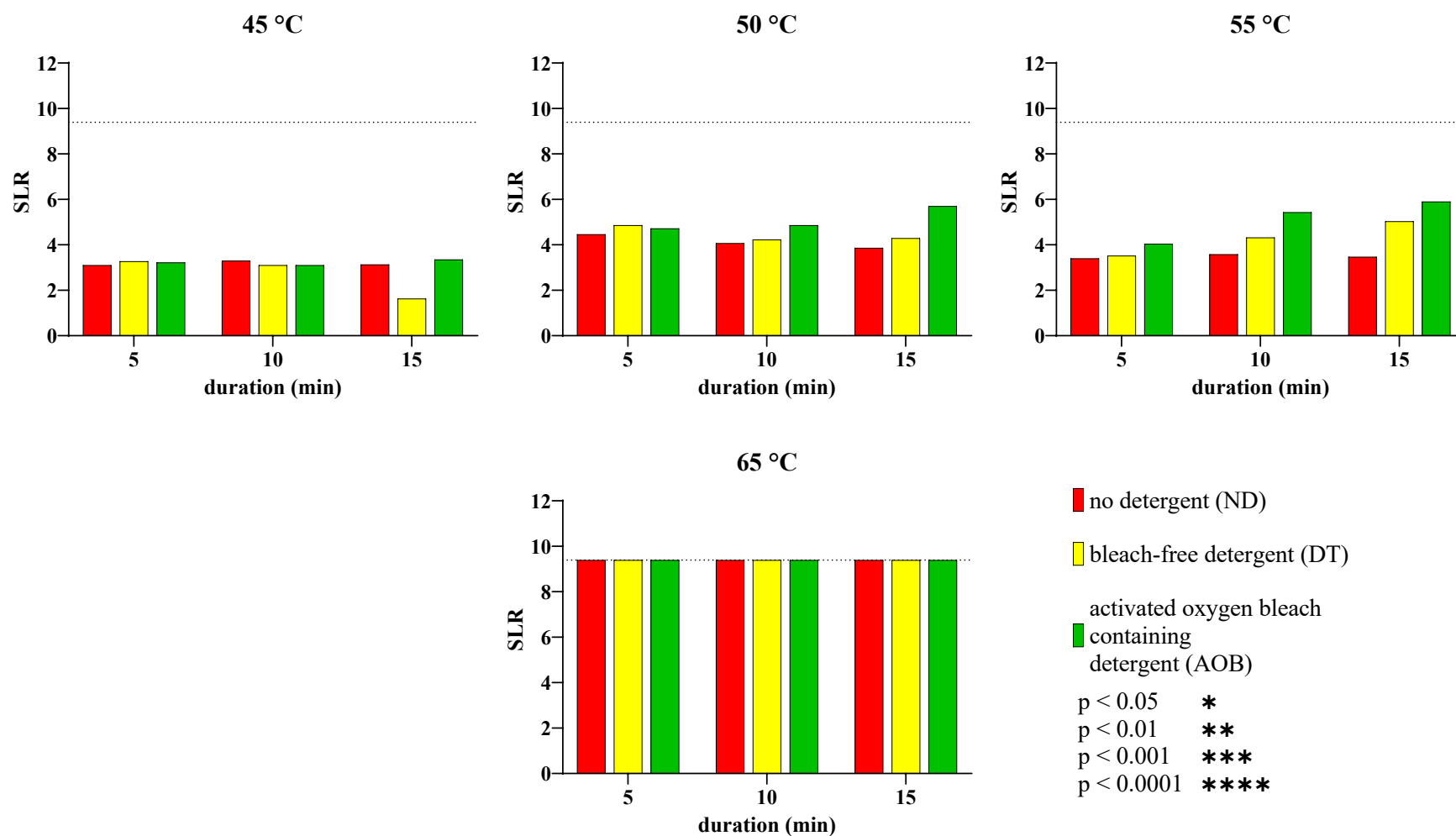

Figure 27: SLR on biomonitors inoculated with biomonitors inoculated with *M. luteus* DSM 1790 after tests in the tergotometer with the given parameters. Statistically significant differences caused by a change in the detergent are marked with asterisks.



**Figure 28: Overview of the standardized logarithmic reductions (SLR) of *M. luteus* DSM 1790 in the water. The dotted lines indicate the maximum SLR. No standard deviations or significances are given due to the small sample size.**



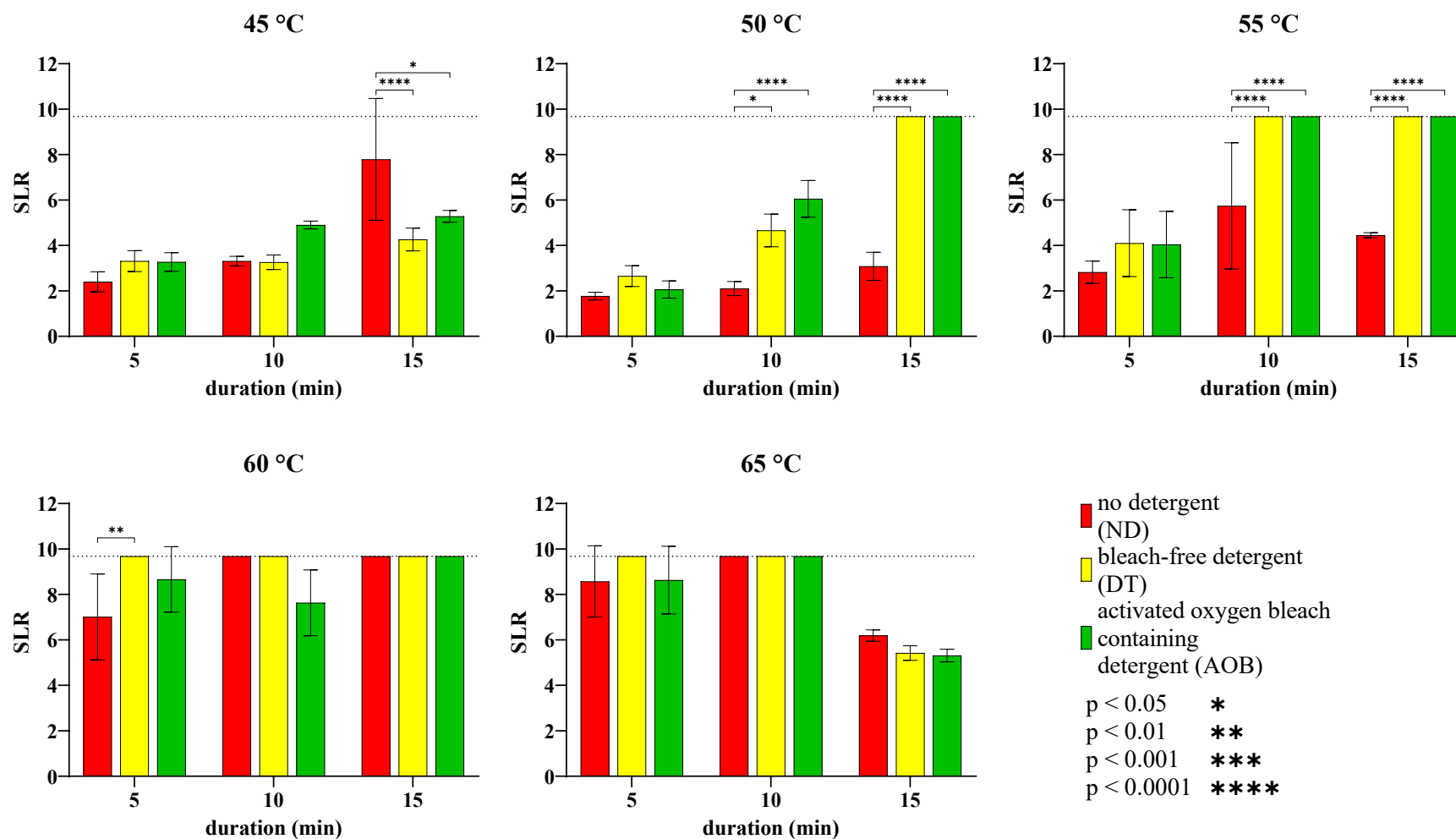

Figure 29: SLR on biomonitors inoculated with *S. aureus* DSM 939 after tests in the tergotometer with the given parameters. Statistically significant differences caused by a change in the detergent are marked with asterisks.

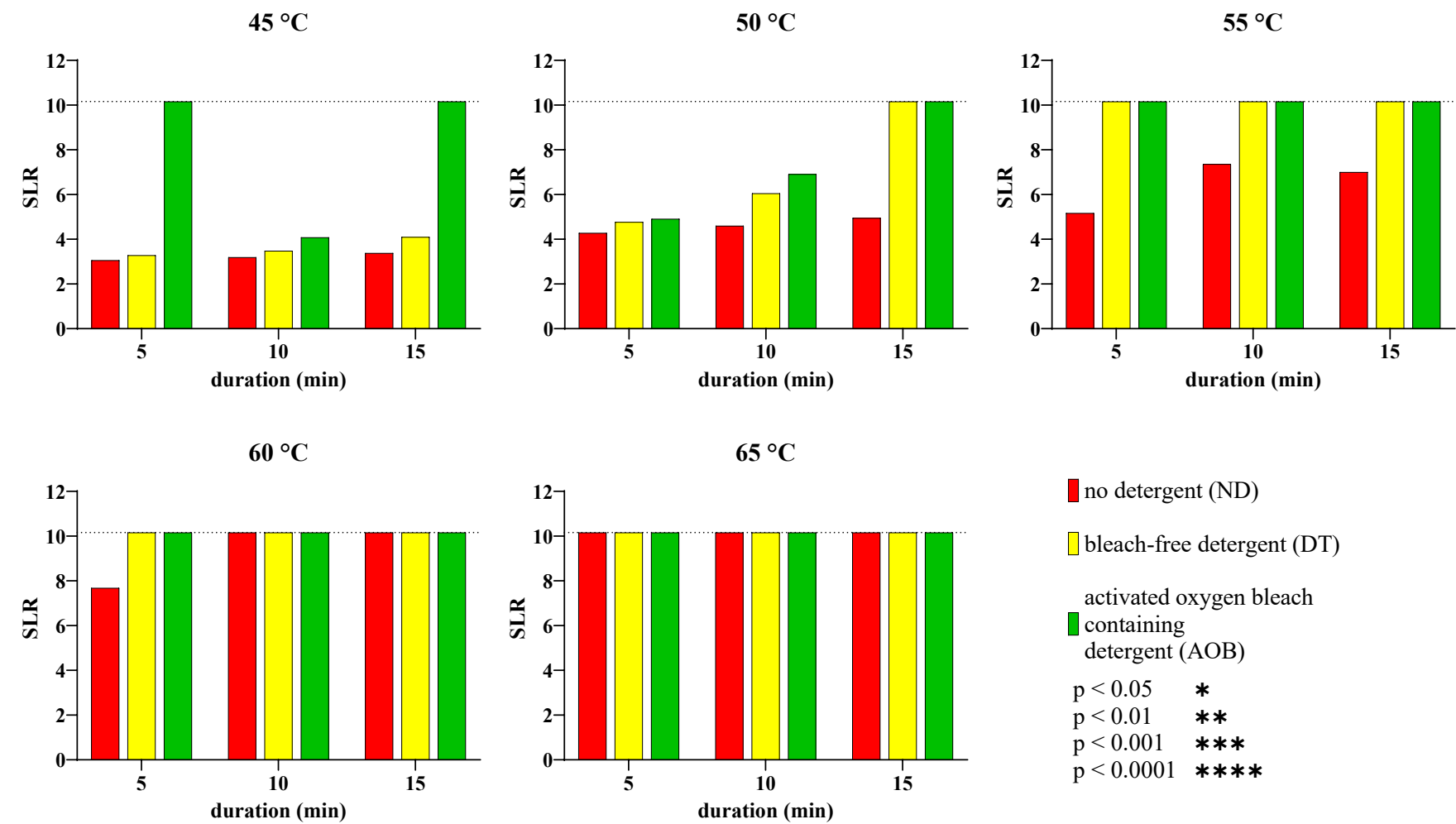

Figure 30: Overview of the standardized logarithmic reductions (SLR) of *S. aureus* DSM 939 in the water. The dotted lines indicate the maximum SLR. No standard deviations or significances are given due to the small sample size.

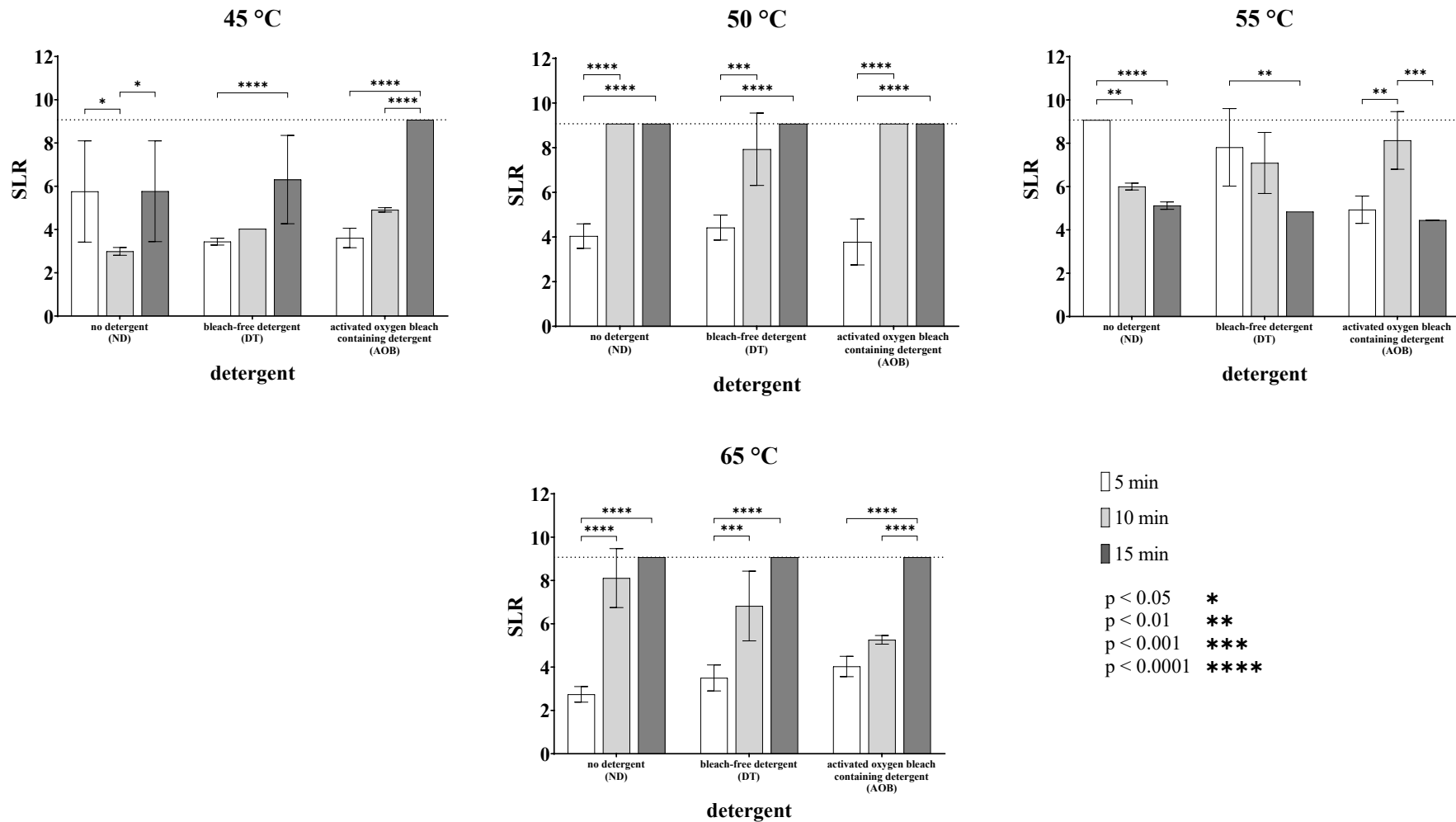

Figure 31: Overview of SLR on biomonitors inoculated with *Ent. faecium* DSM 2146 after tests in the tergotometer with the given parameters. Statistically significant differences caused by a change in the duration are marked with asterisks.

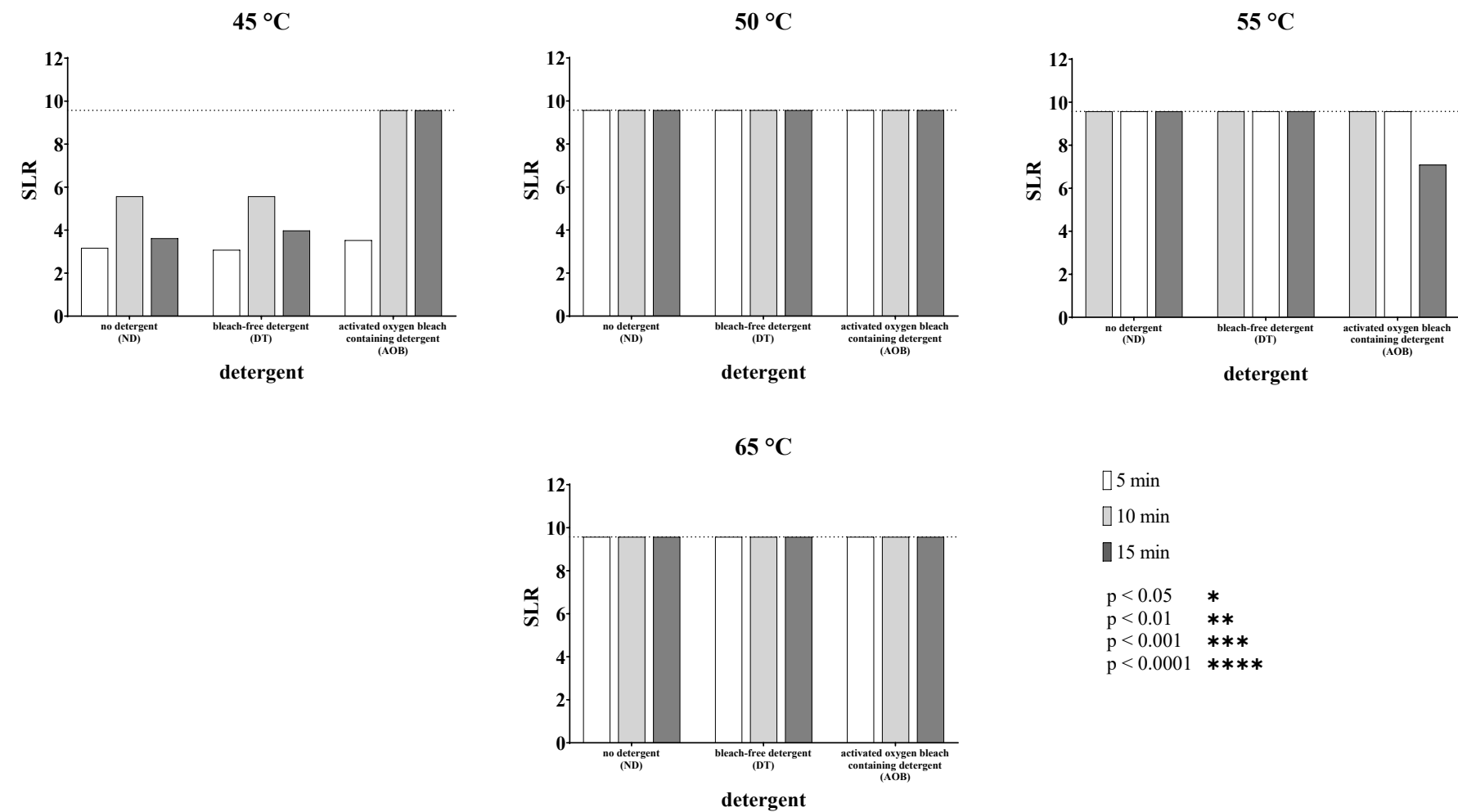

Figure 32: Overview of the SLR of *Ent. faecium* DSM 2146 in the water. The dotted lines indicate the maximum SLR. No standard deviations or significances are given due to the small sample size.

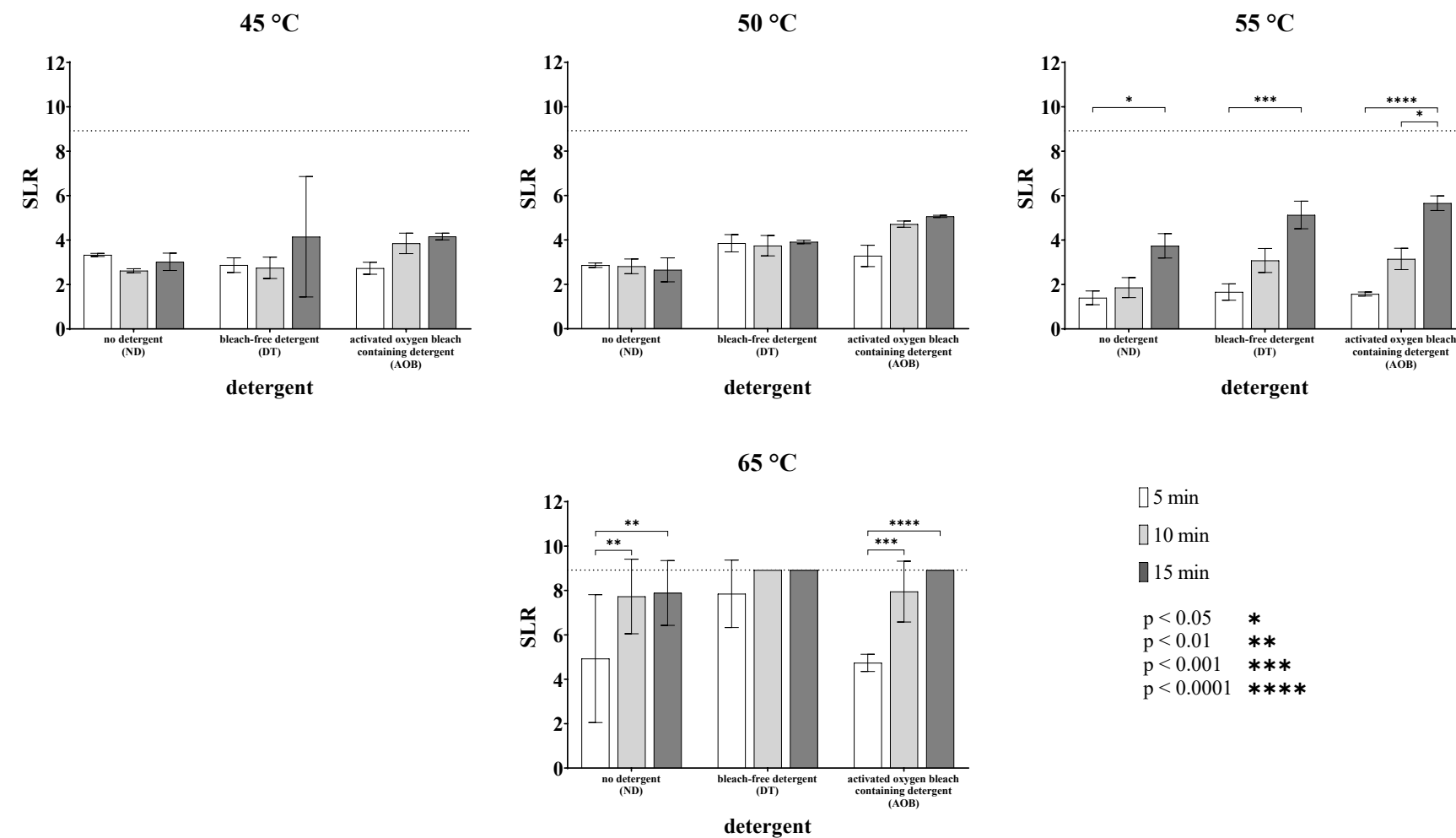

Figure 33: Overview of SLR on biomonitors inoculated with *M. luteus* DSM 1790 after tests in the tergotometer with the given parameters. Statistically significant differences caused by a change in the duration are marked with asterisks.

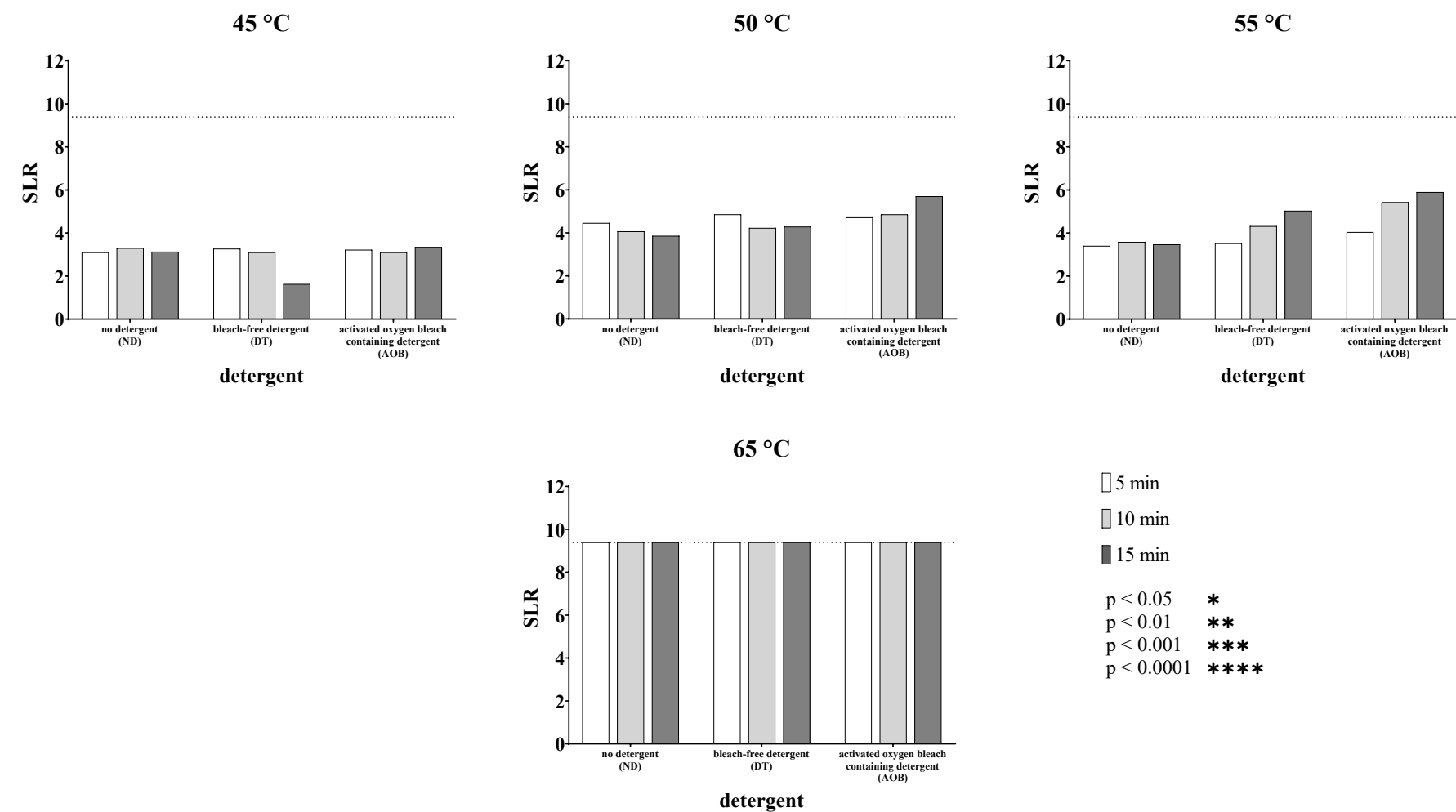

Figure 34: Overview of the SLR of *M. luteus* DSM 1790 in the water. The dotted lines indicate the maximum SLR. No standard deviations or significances are given due to the small sample size.

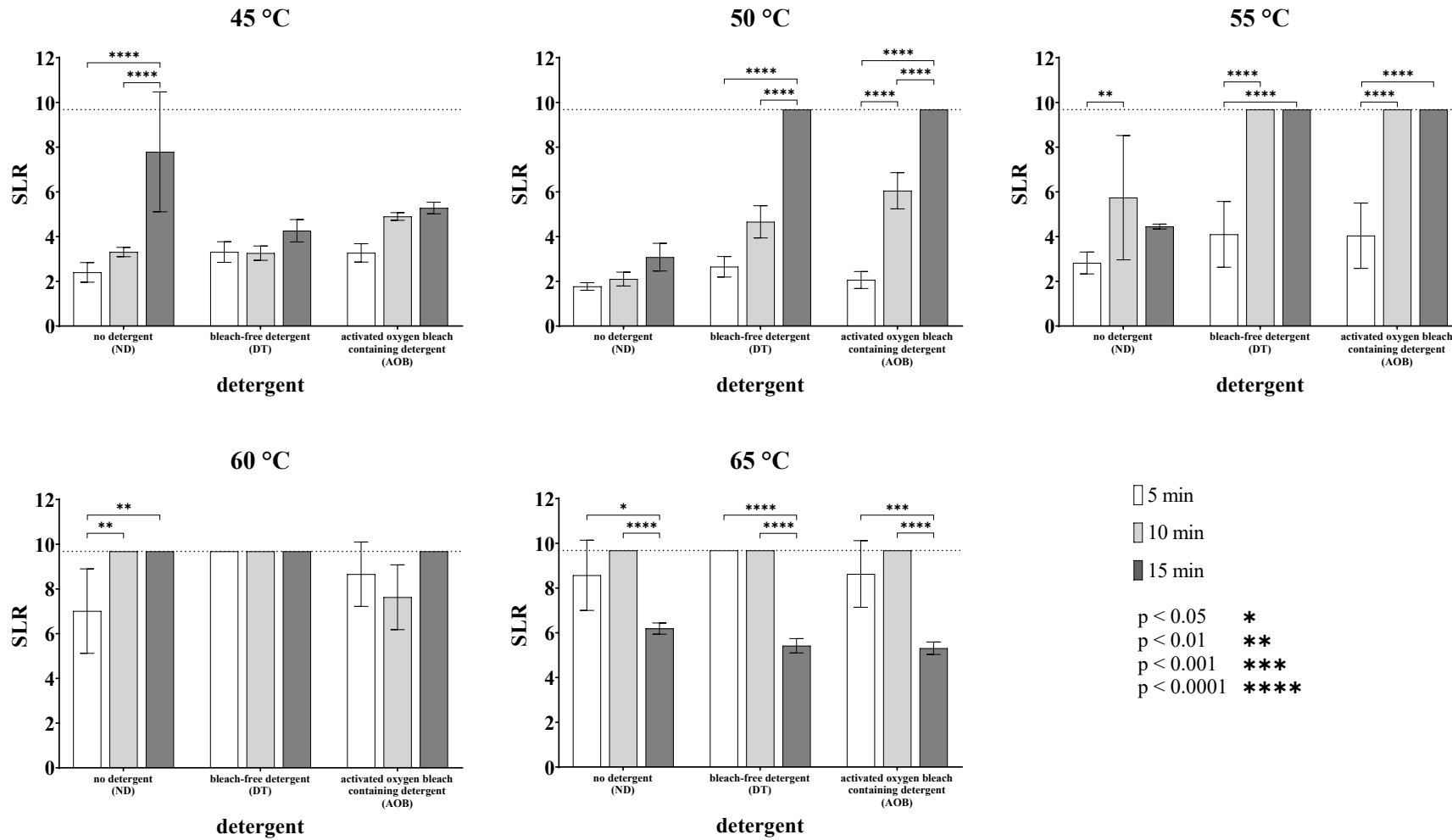

Figure 35: Overview of SLR on biomonitors inoculated with *S. aureus* DSM 939 after tests in the tergotometer with the given parameters. Statistically significant differences caused by a change in the duration are marked with asterisks.

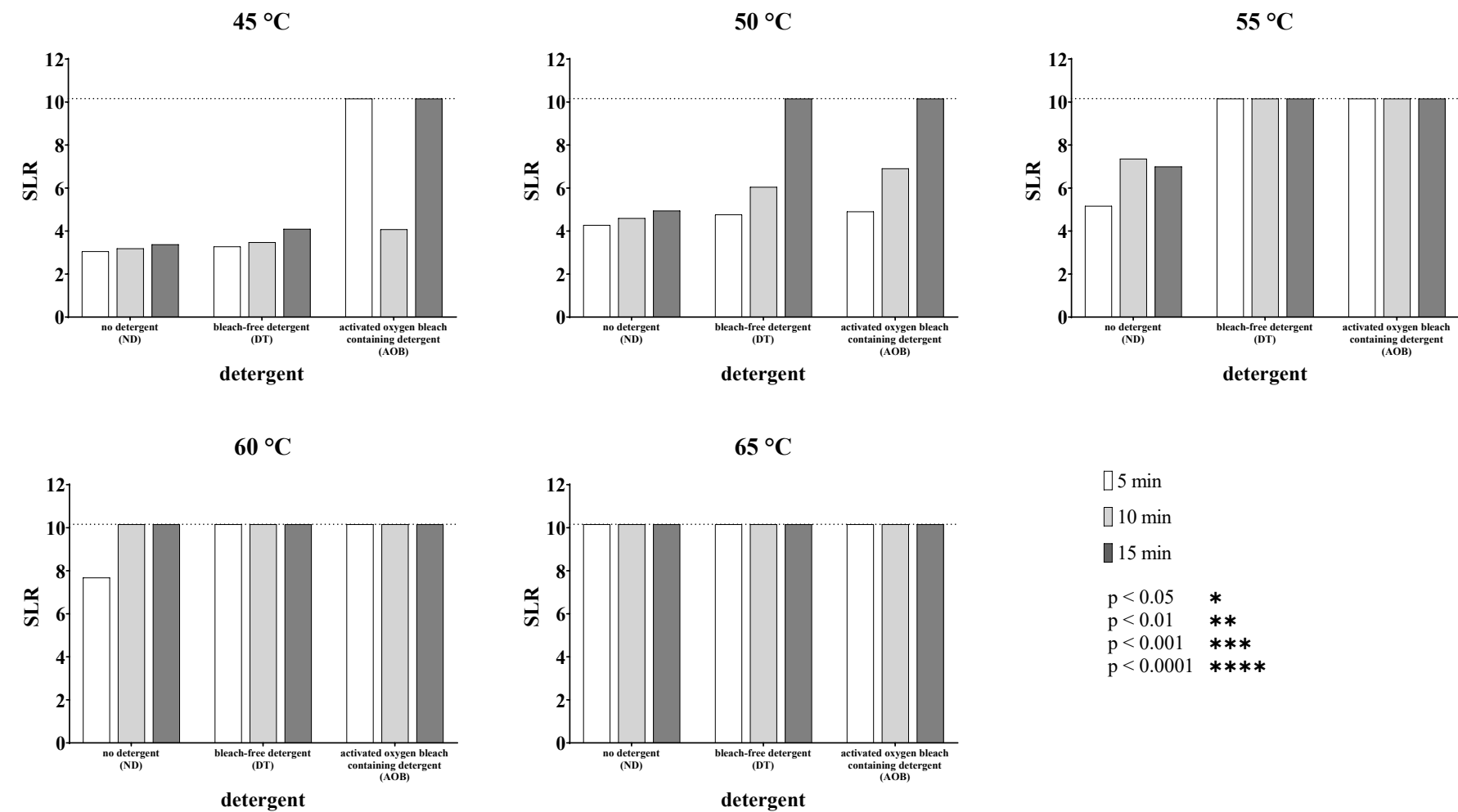

Figure 36: Overview of the SLR of *S. aureus* DSM 939 in the water. The dotted lines indicate the maximum SLR. No standard deviations or significances are given due to the small sample size.



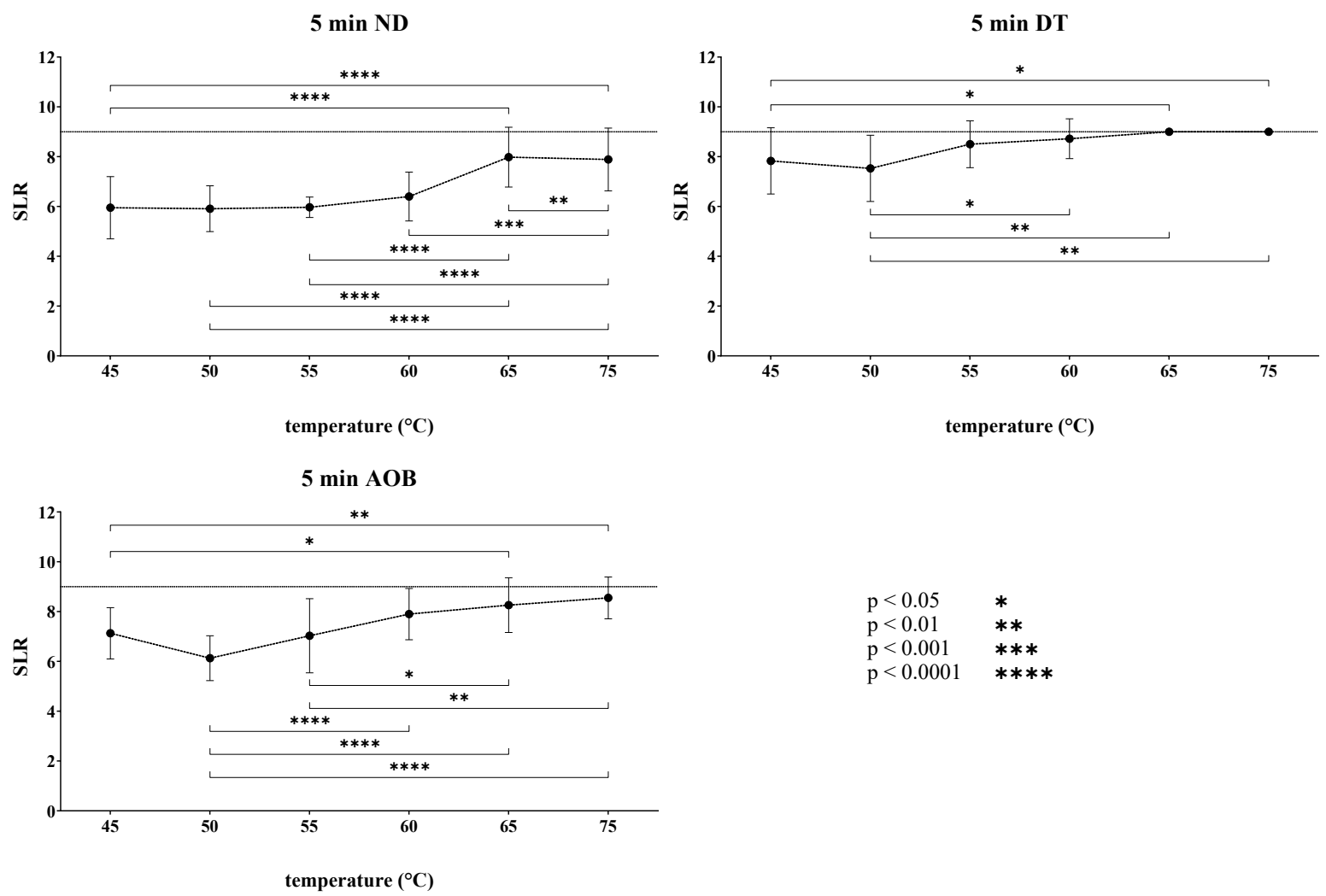

Figure 39: Overview of the standardized logarithmic reductions (SLR) of *Ent. faecium* DSM 2146 on biomonitors used in tests with a duration of 5 min. Statistically significant differences caused by a change in the test temperature are marked with asterisks.

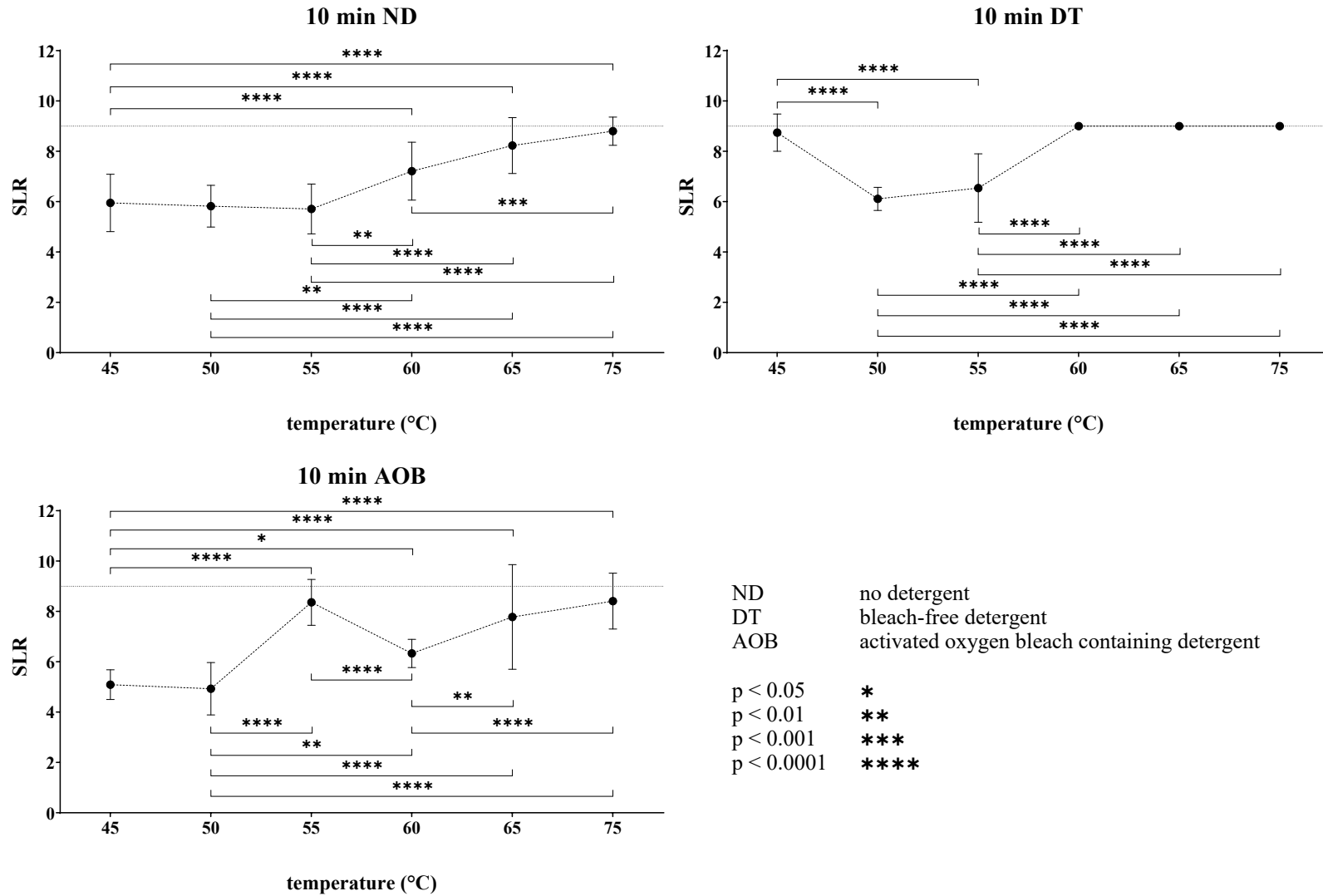

Figure 40: Overview of the standardized logarithmic reductions (SLR) of *Ent. faecium* DSM 2146 on biomonitors used in tests with a duration of 10 min. Statistically significant differences caused by a change in the test temperature are marked with asterisks.

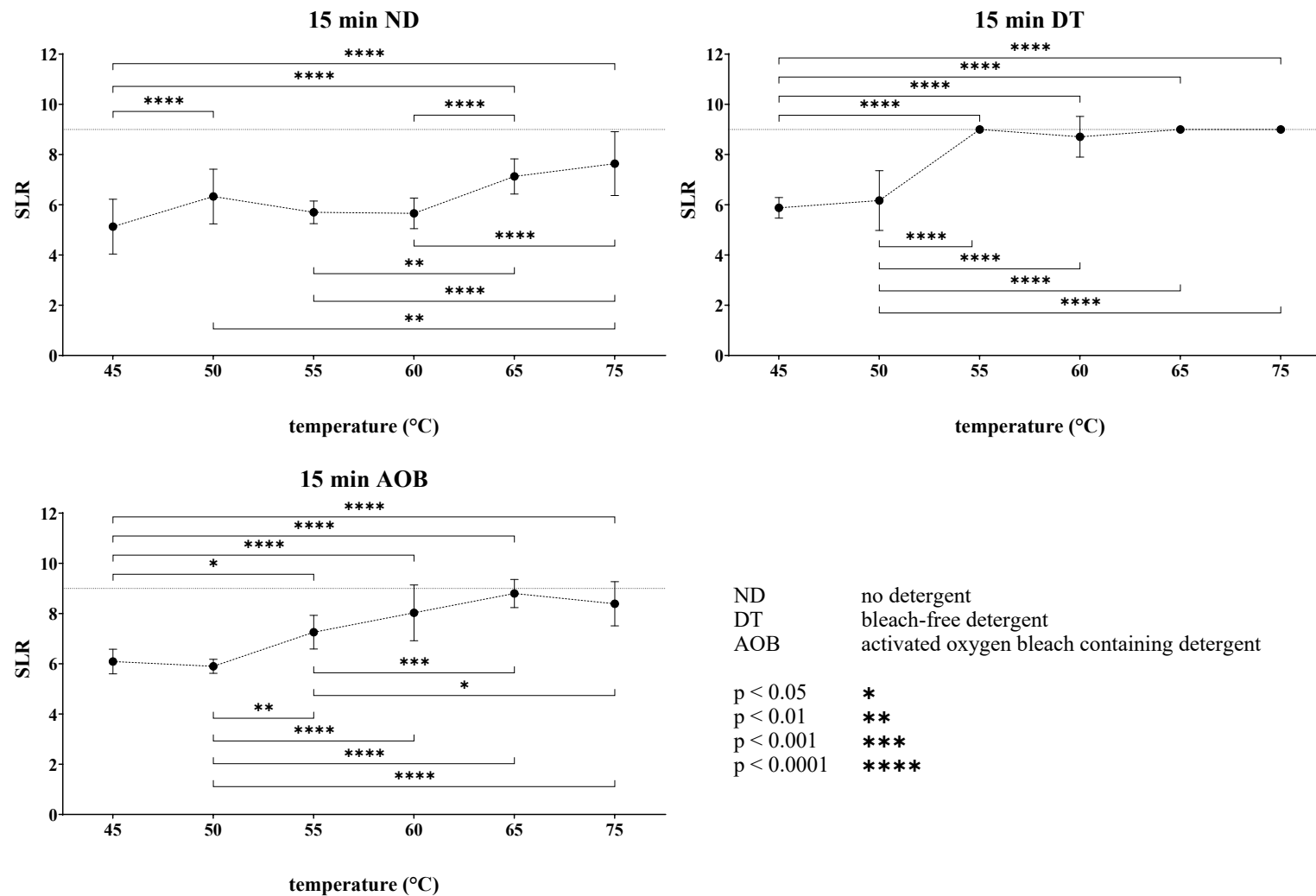
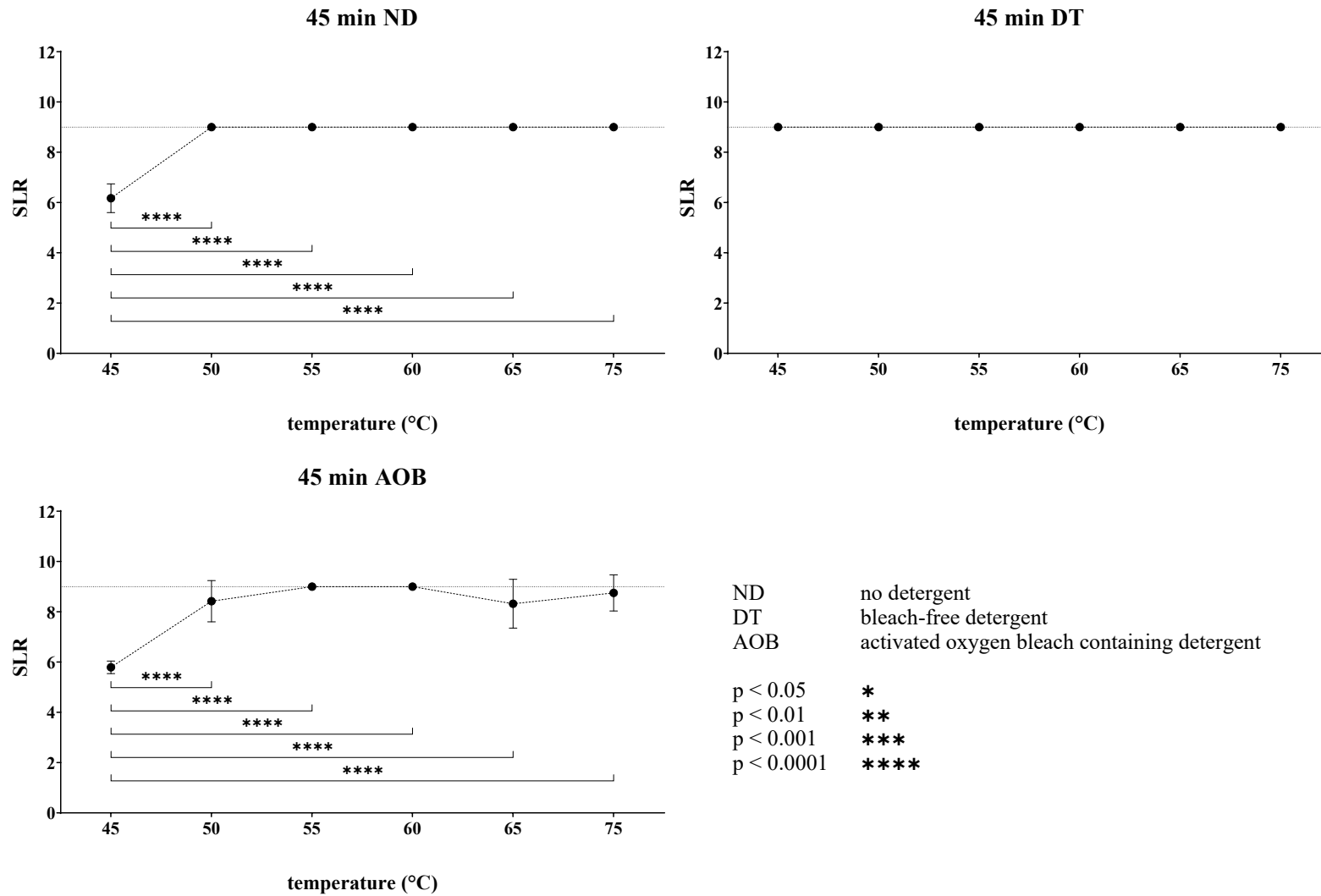

Figure 41: Overview of the standardized logarithmic reductions (SLR) of *Ent. faecium* DSM 2146 on biomonitors used in tests with a duration of 15 min. Statistically significant differences caused by a change in the test temperature are marked with asterisks.



**Figure 42: Overview of the standardized logarithmic reductions (SLR) of *Ent. faecium* DSM 2146 on biomonitors used in tests with a duration of 45 min. Statistically significant differences caused by a change in the test temperature are marked with asterisks.**

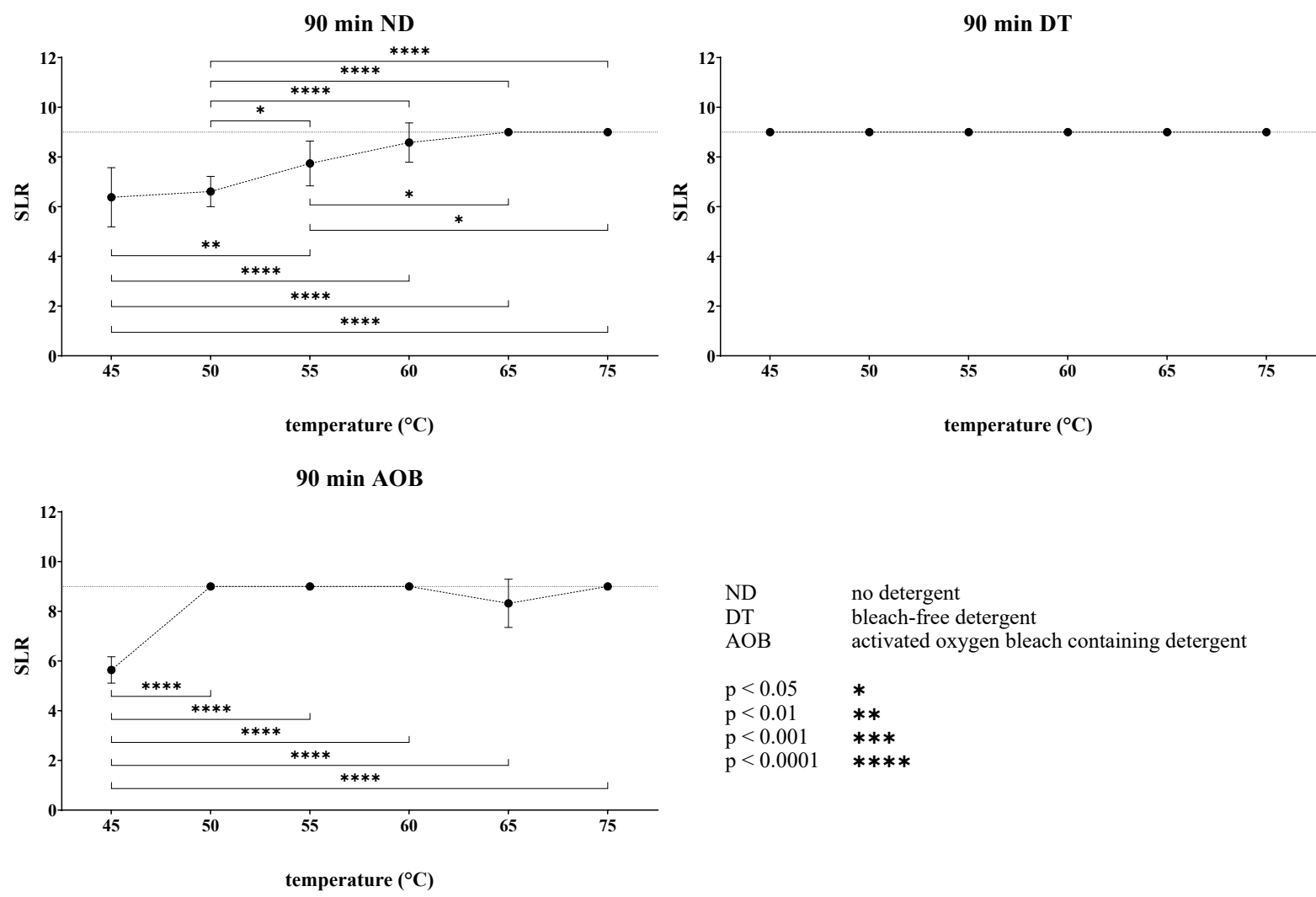
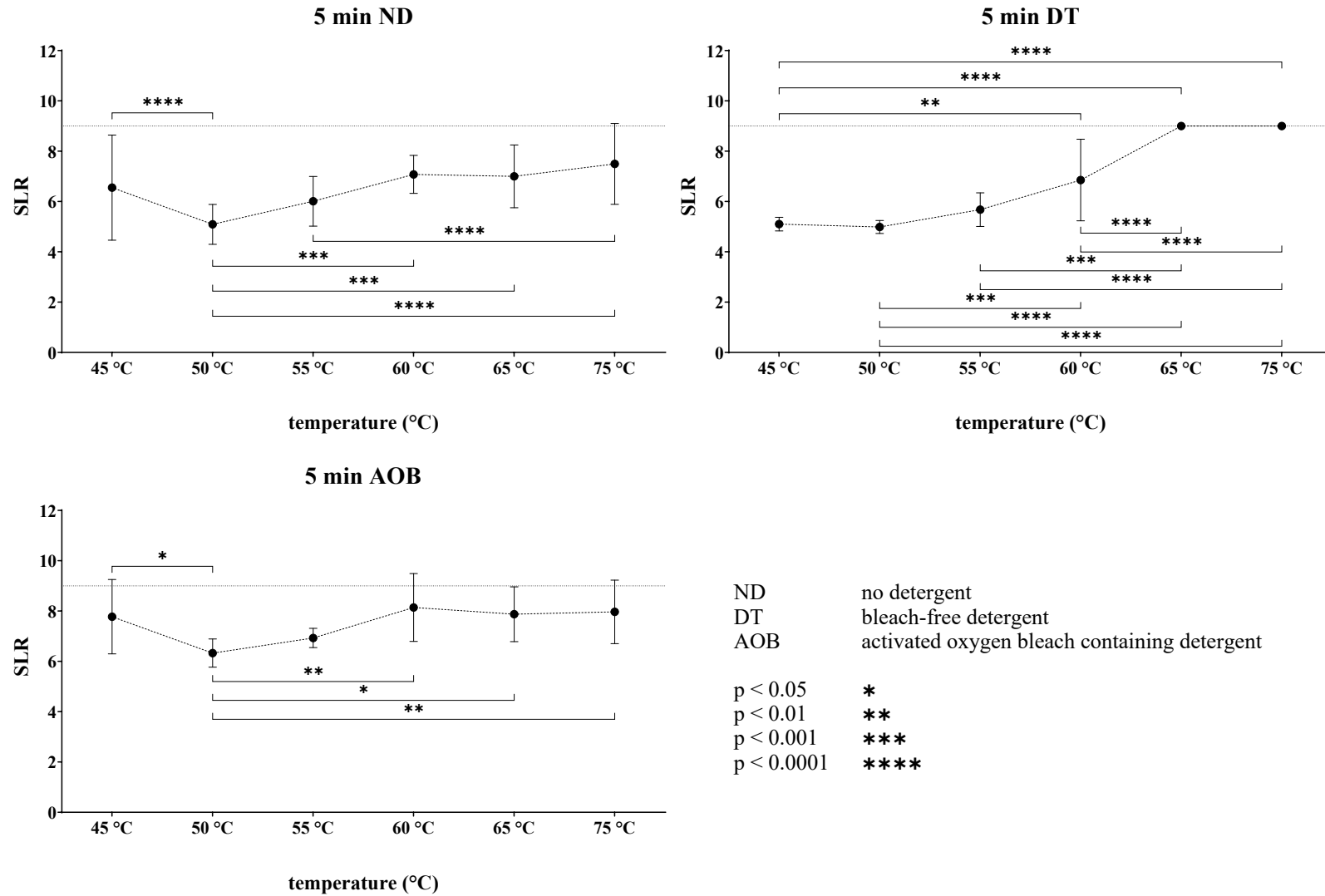

Figure 43: Overview of the standardized logarithmic reductions (SLR) of *Ent. faecium* DSM 2146 on biomonitors used in tests with a duration of 90 min. Statistically significant differences caused by a change in the test temperature are marked with asterisks.



**Figure 44: Overview of the standardized logarithmic reductions (SLR) of *M. luteus* DSM 1790 on biomonitors used in tests with a duration of 5 min. Statistically significant differences caused by a change in the test temperature are marked with asterisks.**

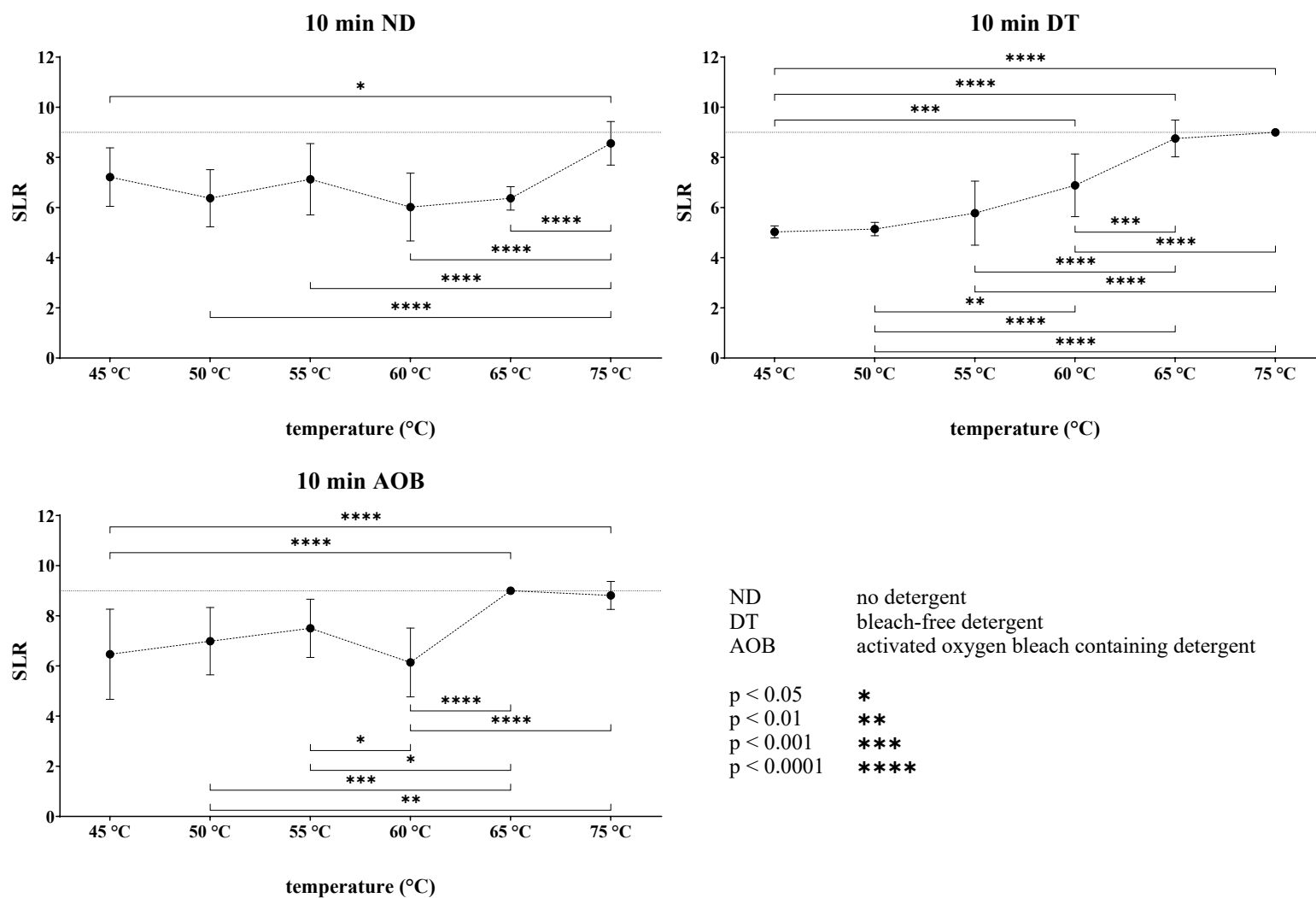
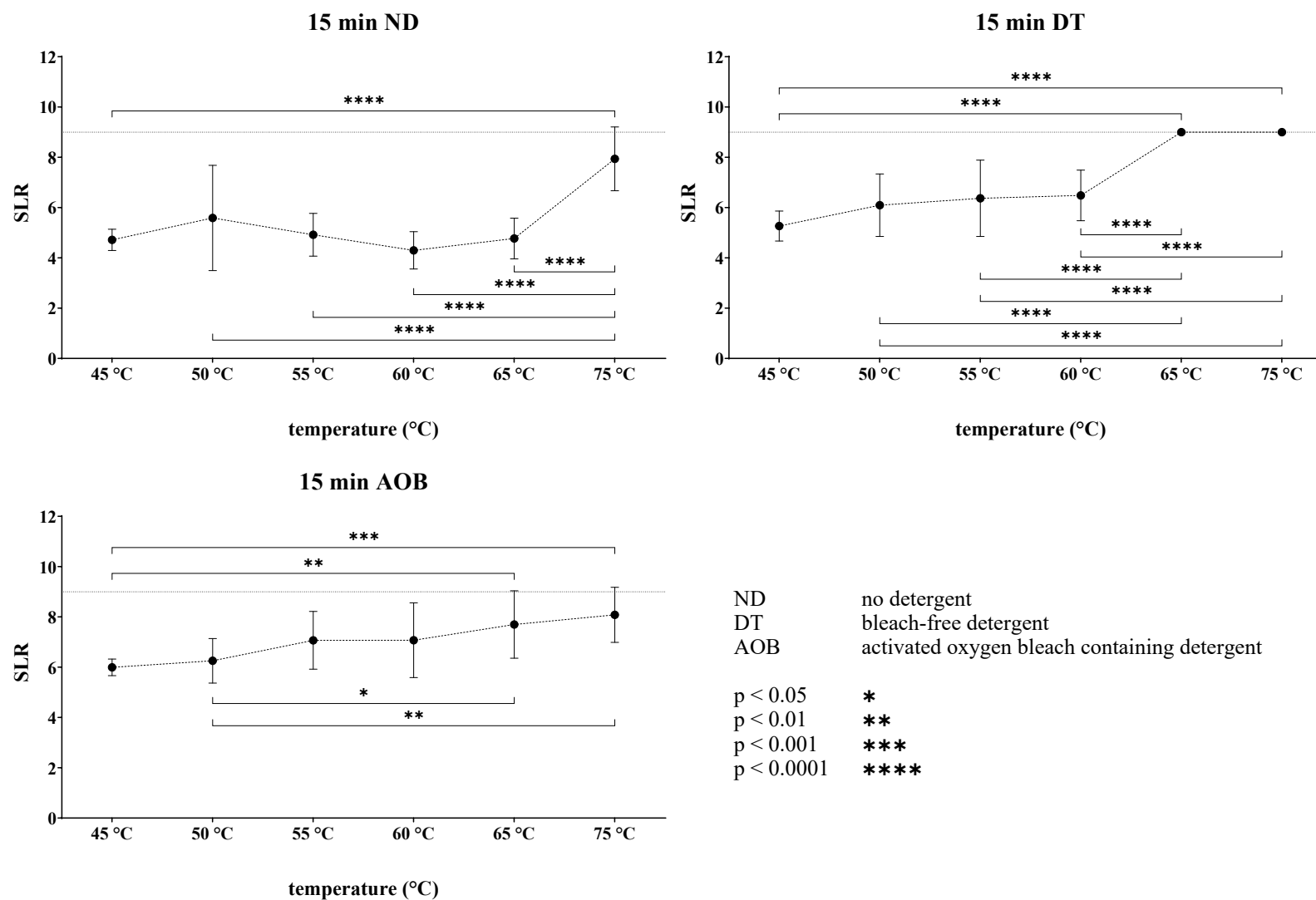
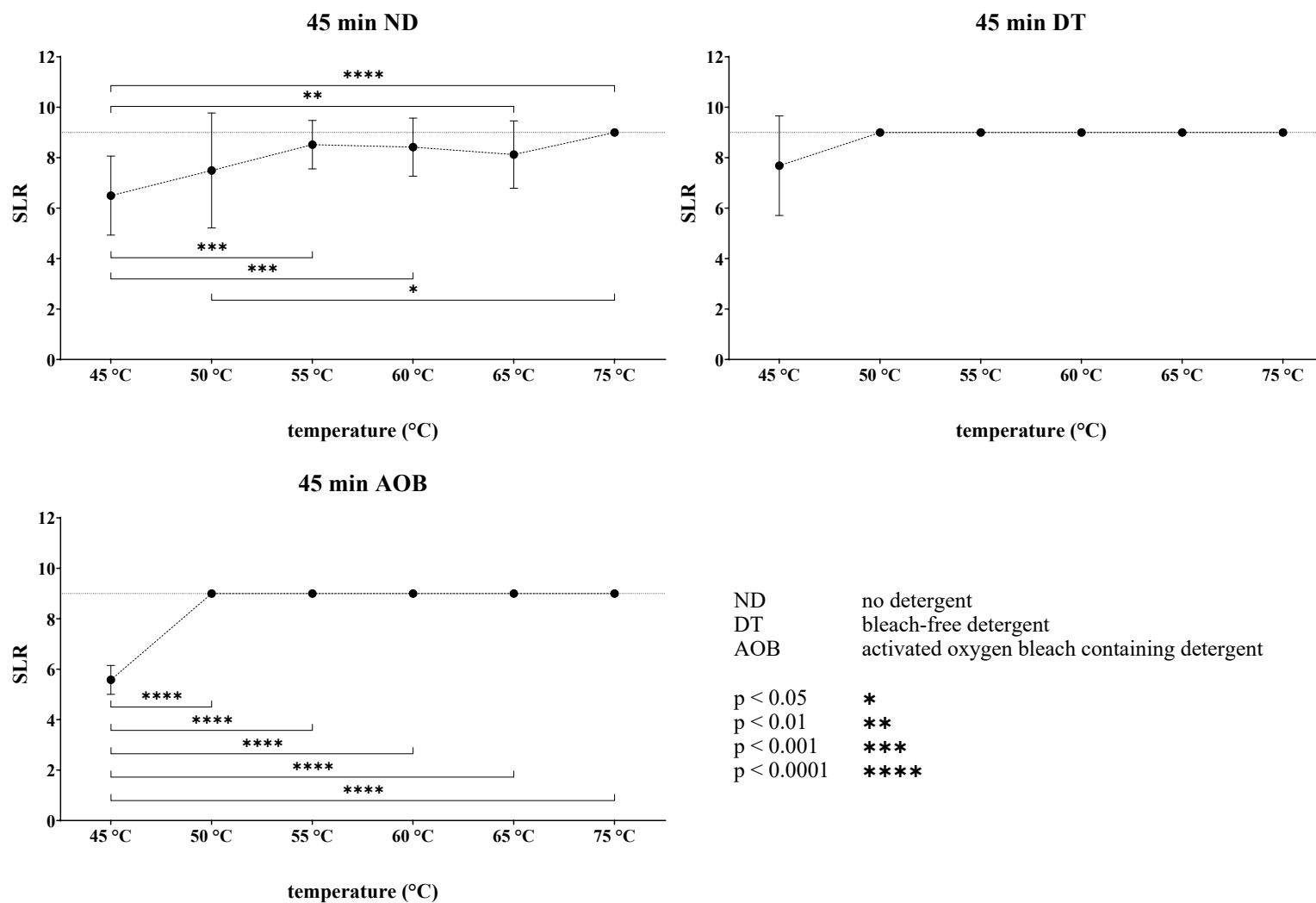

Figure 45: Overview of the standardized logarithmic reductions (SLR) of *M. luteus* DSM 1790 on biomonitors used in tests with a duration of 10 min. Statistically significant differences caused by a change in the test temperature are marked with asterisks.

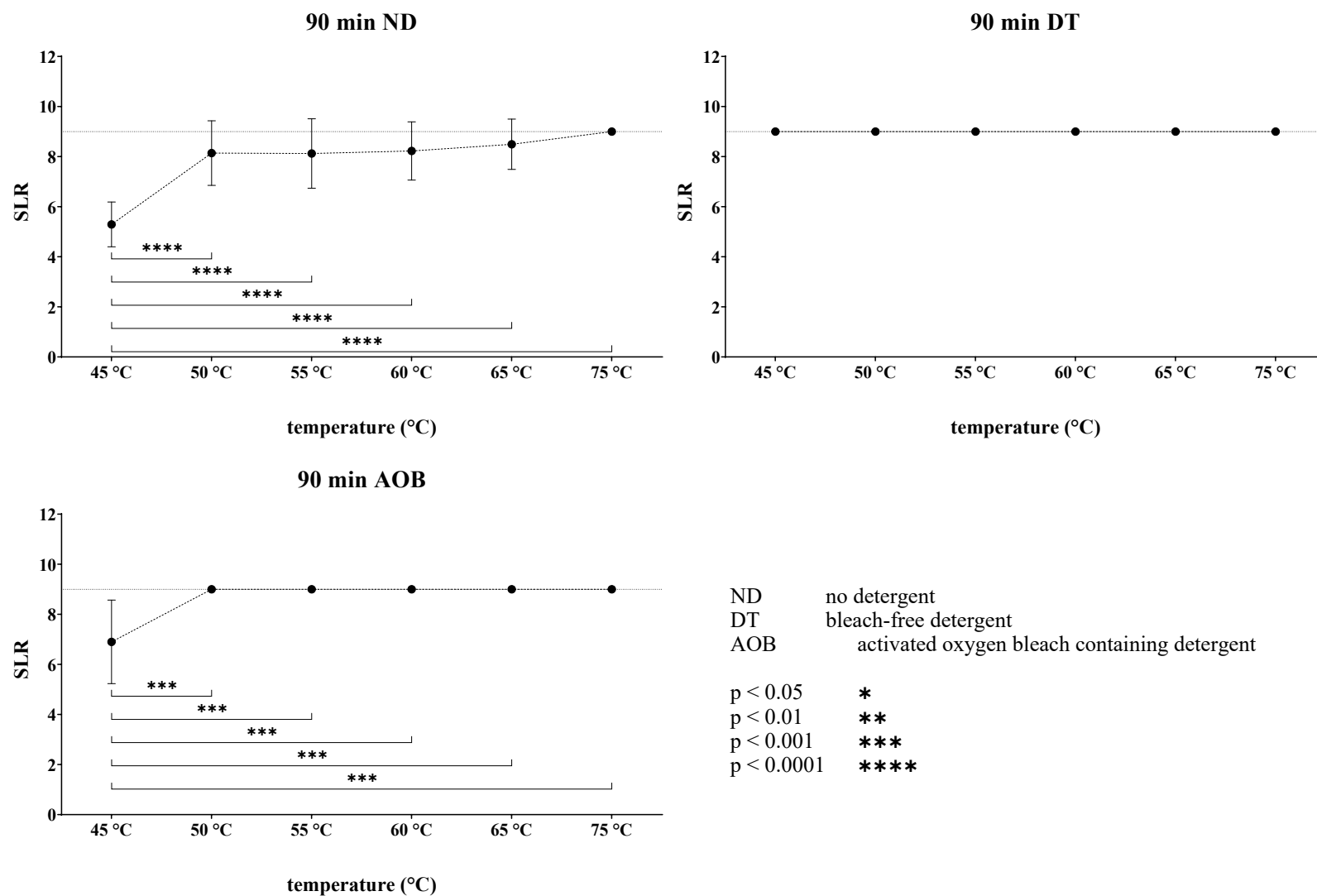

**Figure 46: Overview of the standardized logarithmic reductions (SLR) of *M. luteus* DSM 1790 on biomonitors used in tests with a duration of 15 min. Statistically significant differences caused by a change in the test temperature are marked with asterisks.**

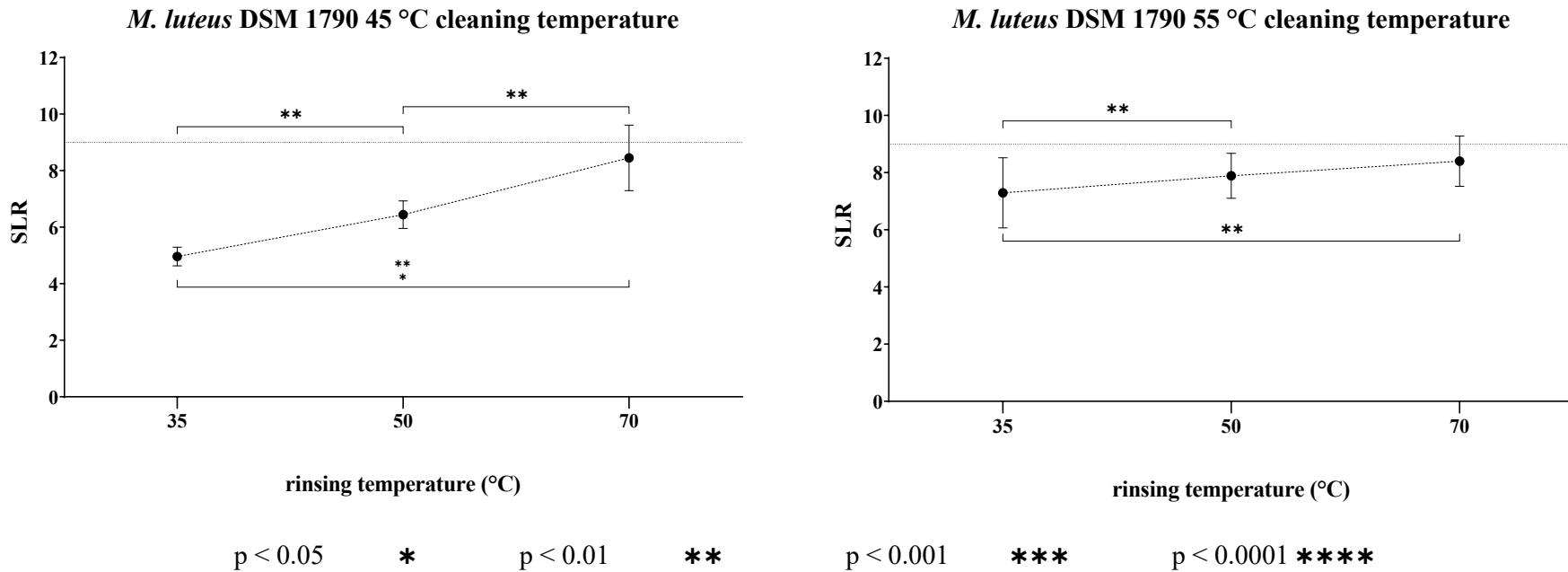



**Figure 47: Overview of the standardized logarithmic reductions (SLR) of *M. luteus* DSM 1790 on biomonitors used in tests with a duration of 45 min. Statistically significant differences caused by a change in the test temperature are marked with asterisks.**



**Figure 48: Overview of the standardized logarithmic reductions (SLR) of *M. luteus* DSM 1790 on biomonitors used in tests with a duration of 90 min. Statistically significant differences caused by a change in the test temperature are marked with asterisks.**



**Figure 50.1: Overview of the standardized logarithmic reduction (SLR) of *M. luteus* DSM 1790 on biomonitors caused by a change of the rinsing temperature in tests with the given cleaning temperatures. Statistically significant differences are marked with asterisks. Lines are for visualization only.**

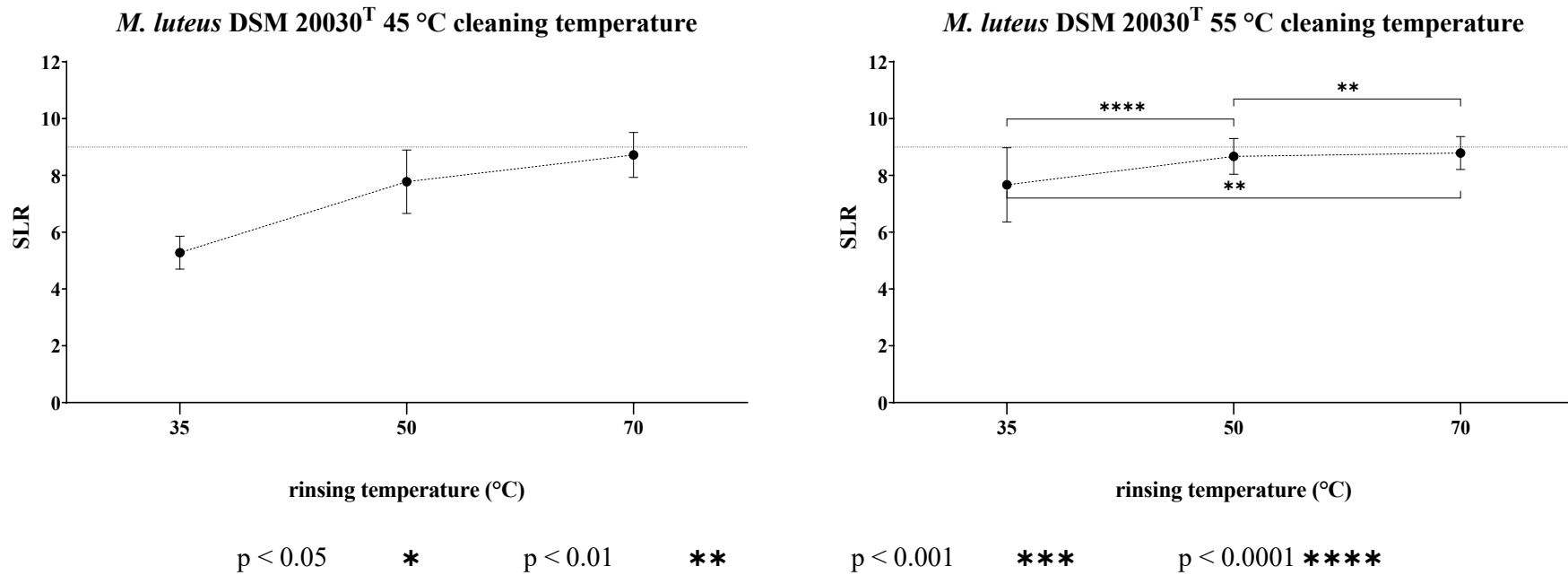

**Figure 50.2: Overview of the standardized logarithmic reduction (SLR) of *M. luteus* DSM 20030<sup>T</sup> on biomonitors caused by a change of the rinsing temperature in tests with the given cleaning temperatures. Statistically significant differences are marked with asterisks. Lines are for visualization only.**

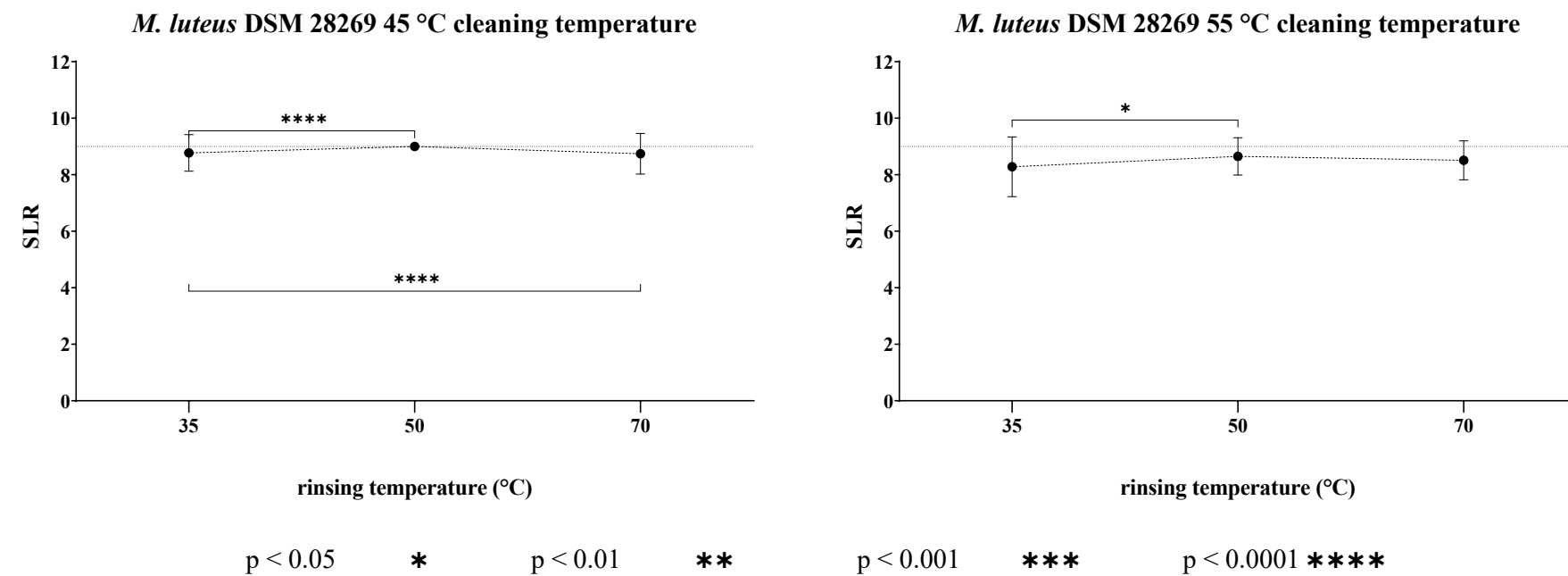

**Figure 50.3: Overview of the standardized logarithmic reduction (SLR) of on biomonitors caused by a change of the rinsing temperature in tests with the given cleaning temperatures. Statistically significant differences are marked with asterisks. Lines are for visualization only.**

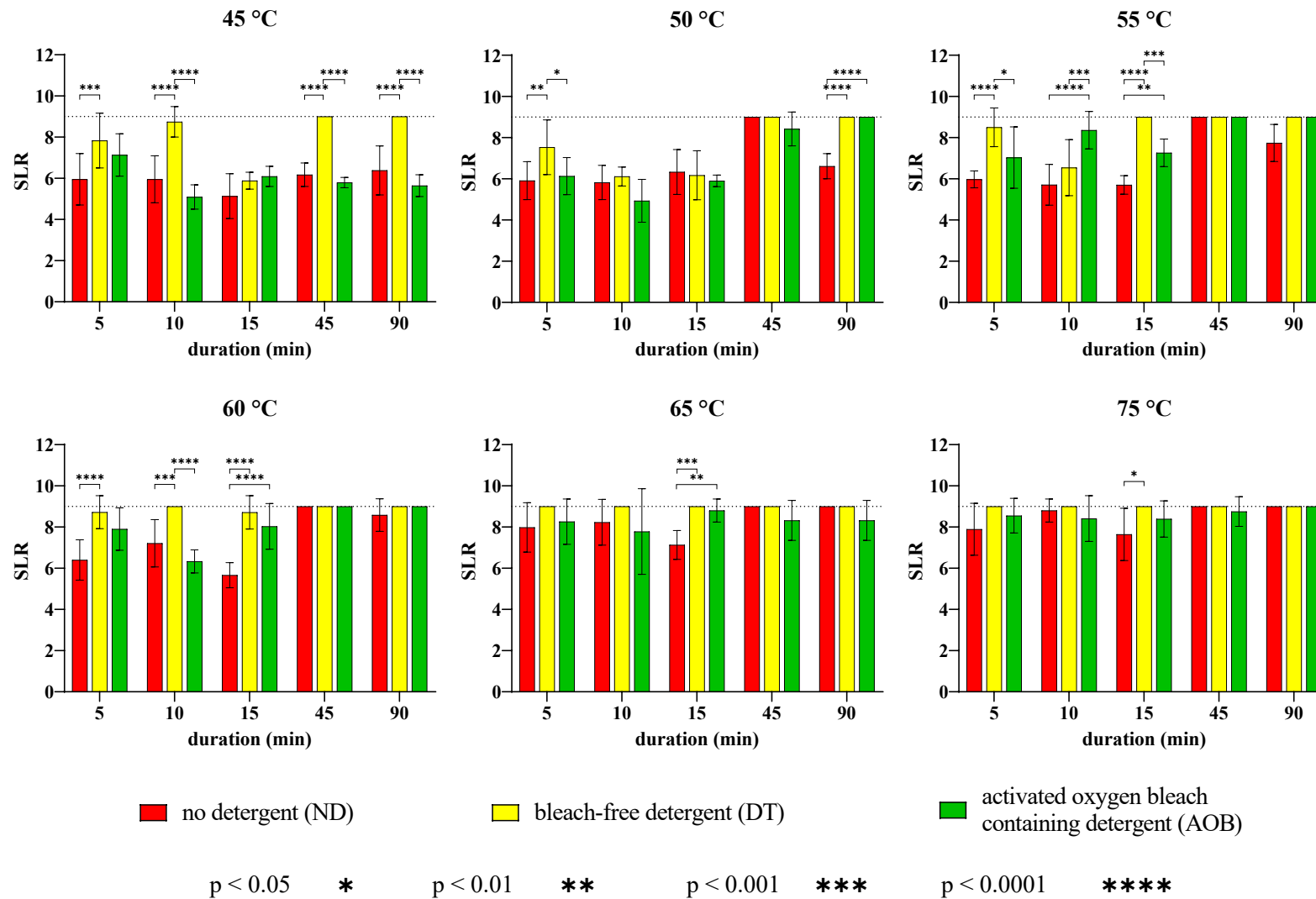

Figure 51: Overview of the standardized logarithmic reductions (SLR) of *Ent. faecium* DSM 2146 on biomonitors. Statistically significant results caused by different detergent types are marked with asterisks.

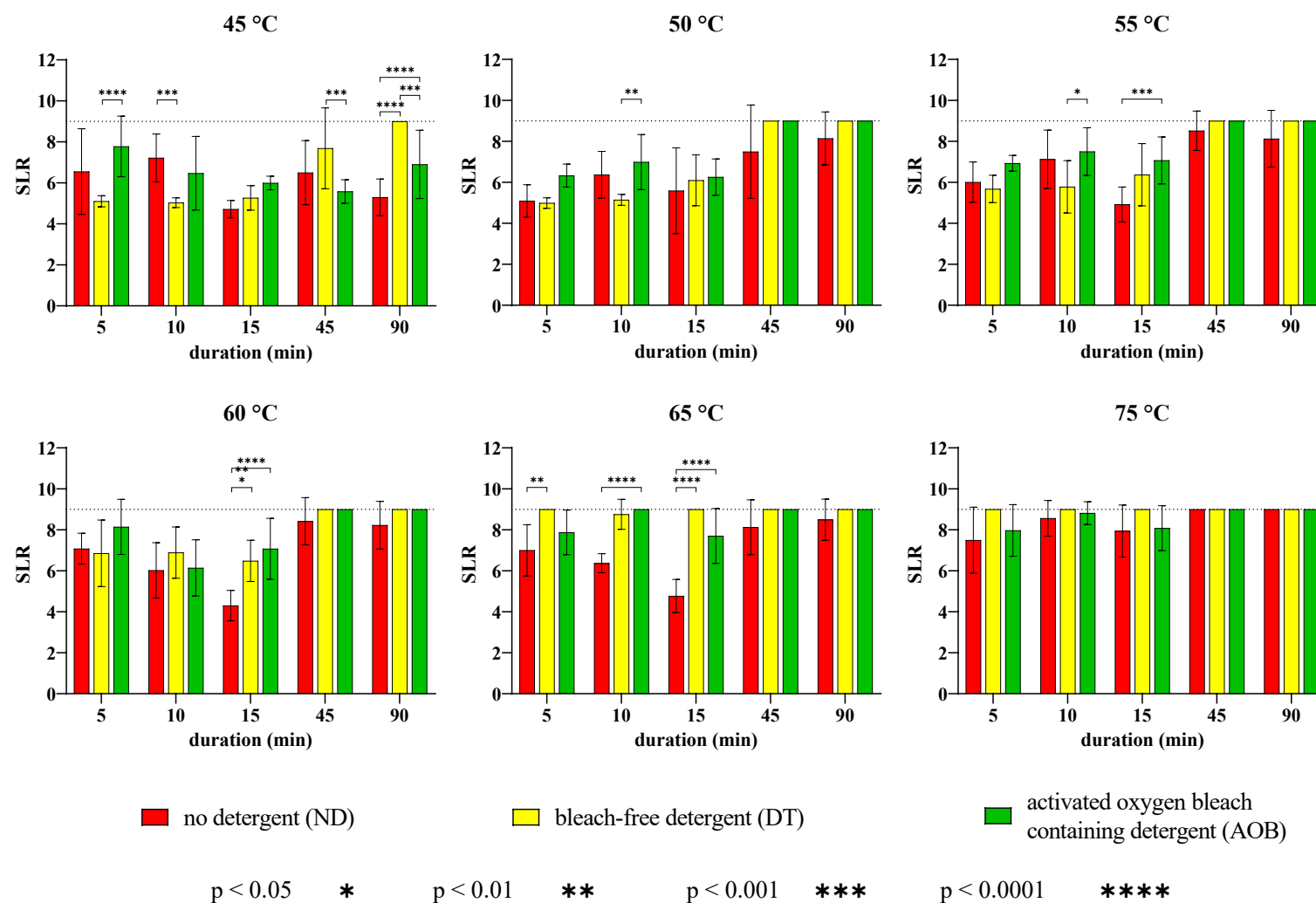

Figure 52: Overview of the standardized logarithmic reductions (SLR) of *M. luteus* DSM 1790 on biomonitors. Statistically significant differences caused by a change of the detergent are marked with asterisks.

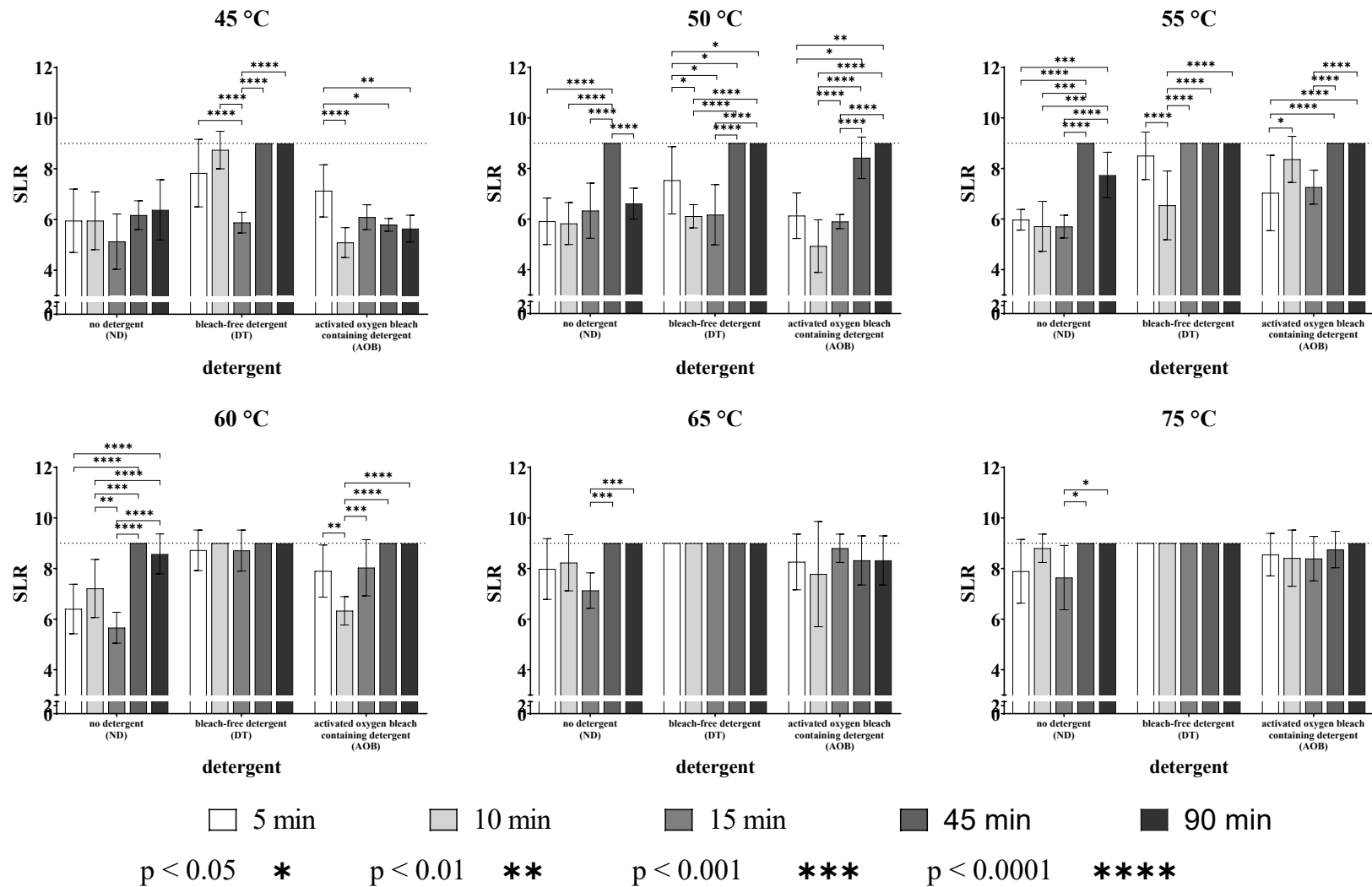

Figure 53: Overview of the standardized logarithmic reductions (SLR) of *Ent. faecium* DSM 2146 on biomonitors. Statistically significant differences caused by a change of the cleaning duration are marked with asterisks.



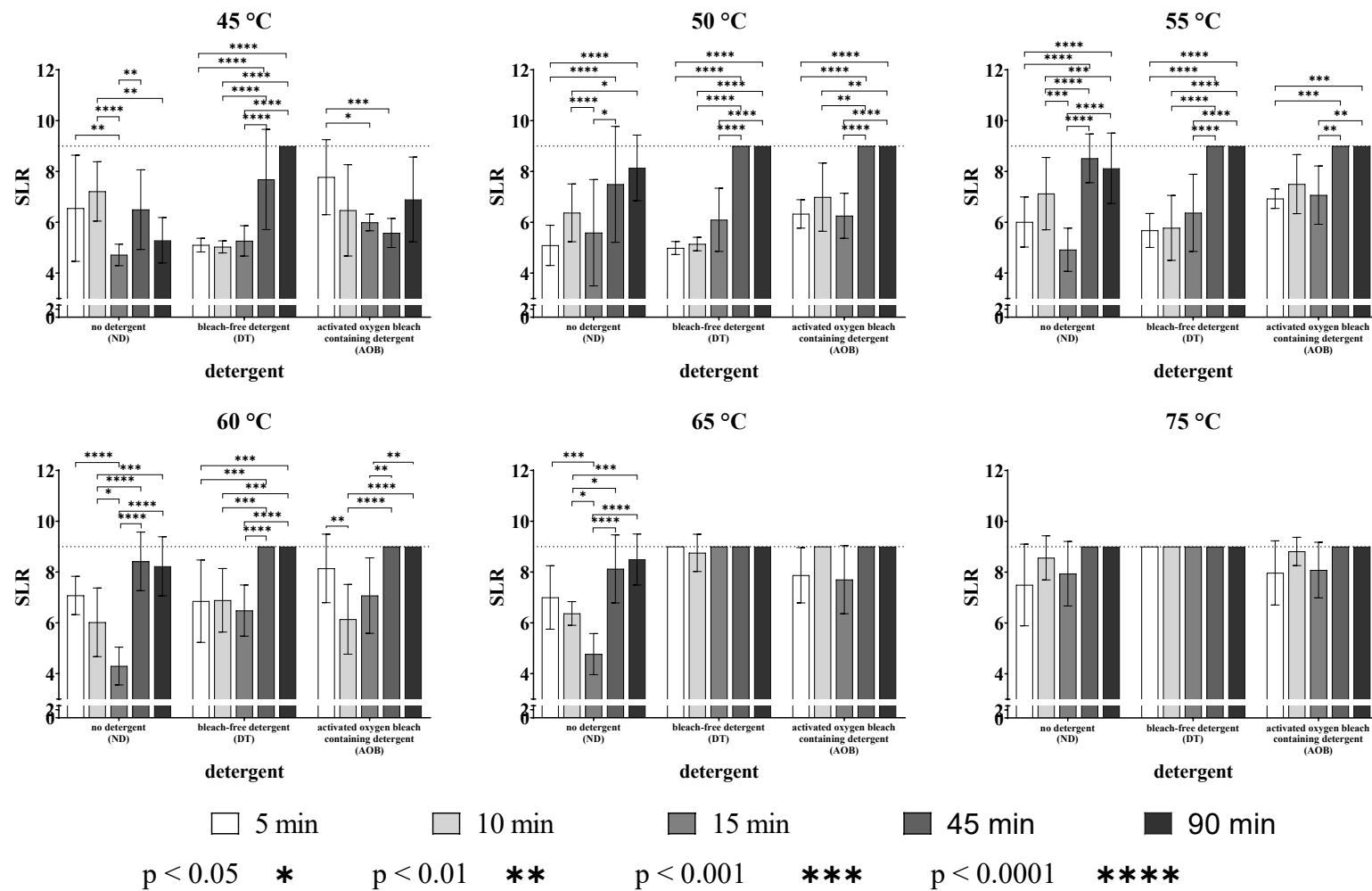

Figure 54: Overview of the standardized logarithmic reductions (SLR) of *M. luteus* DSM 1790 on biomonitors. Statistically significant differences caused by a change of the cleaning duration are marked with asterisks.

## **Acknowledgements – Danksagung**

My special thanks go to Prof. Dr. André Lipski for taking on the supervision and for the opportunity the work on this thesis gave me. I would further like to thank him for the interesting discussions and food for thought throughout the process. His constructive criticism was invaluable.

I would like to thank Prof. Dr. Dirk Bockmühl for making the topic available, for the freedom he gave me while working on it and for his support over the years. Thank you for the chance you gave me and for the challenges on which I could grow.

I would further like to thank Prof. Dr. Rainer Stamminger for the uncounted helpful discussions within and outside the working group. I really appreciated our collaboration and the input and expertise from which I learned a lot.

Furthermore, I would like to thank the members of the IEC53A WG3 working group for the many interesting discussions, comments, tips and regular exchange during the development of the method and I especially would like to thank Caroline Amberg from Swissatest Testmaterialien for our great collaboration and the exchanges and discussions we had in person or online.

A special thanks goes to Sarah Schulze Struchtrup from the Household and Appliance Technology section at the Institute for Agricultural Engineering at the University of Bonn. Thank you for the great cooperation. Our meetings and the detailed discussions were always very interesting and fruitful. It was a pleasure to have such a supportive and nice colleague.

I would especially like to thank all my colleagues in the faculty of Life Sciences at Rhine-Waal University for the good working atmosphere and your willingness to help. I thank all members of the working group Hygiene and Microbiology and in particular Ralf Lucassen, Nadine Merettig, and the former group member Marlitt Honisch for countless discussions, fruitful cooperation on common topics, but also for a quick word or a cup of coffee when needed.

Herzlichen Dank auch an meine Freunde Sascha, Sandra and Stefan, die mich während der Entstehung dieser Arbeit jederzeit und auf verschiedene Arten unterstützt haben.

Zuletzt möchte ich meiner Familie und insbesondere meinen Eltern danken, ohne die ich sicherlich niemals die Chance bekommen hätte, diesen Weg einzuschlagen. Vielen Dank dafür, dass ihr mich immer unterstützt und an mich glaubt!